



TeamItalia®

Lighting

General Catalogue 2022

Clicca sui prodotti
Push on the products
Klicken Sie auf die Produkte



 Indice generale / General index / Allgemeiner Index

 Indice fotografico / Photographic index / Fotografischer index

 Indice famiglia / Family index / Familienindex

La luce è sempre più protagonista degli ambienti con nuove soluzioni per gli stili di vita di oggi. Noi di Teamitalia proponiamo elementi versatili ed esclusivi, ideali per ogni spazio ed esigenza. Questo catalogo presenta i prodotti perfetti per l'interior, racchiusi nella sezione HOME, dedicati ai progettisti in ARCHITECTURAL e per illuminare gli esterni nell'area OUTDOOR. **"Ad ogni ambiente la propria luce"**.

Light is becoming more and more the protagonist of environments with new solutions for today's lifestyles. At Teamitalia we offer versatile and exclusive elements, ideal for any space and need.

This catalog introduces the perfect products for the interiors, in the HOME section, dedicated to designers in ARCHITECTURAL and to lighten the exteriors in the OUTDOOR area. **"To each space its own light"**.

Das Licht ist zunehmend der Hauptdarsteller der Umgebungen mit neuen Lösungen für den heutigen Lebensstil. Wir bei Teamitalia bieten vielseitige und exklusive Elemente, die ideal für jeden Raum und Bedarf sind.

Dieser Katalog präsentiert die perfekten Produkte für den Innenraum, im Abschnitt HOME enthalten, für Designer, im ARCHITECTURAL-Bereich verfügbar, und zur Außenbeleuchtung, unter OUTDOOR vorhanden. **"Zu jedem Raum ein eigenes Licht"**.



HOME



ARCHITECTURAL



OUTDOOR



PROFILI

ARIELL	126	BELLAI	286	BELLAI	480	ANGOLARE	394
BELLAI HOME	38	BELLAI UP	296	DOT	508	BASIC	398
COMPACT	140	EDGE	266	DROP	486	INCASSO CON CORNICE	422
CURVE	80	EMME 24	218	FLIP	518	INCASSO CON CORNICE C	426
EDGE H	62	MICRO	316	LEGGERA	472	INCASSO CON CORNICE M	438
LEGGERA	24	MINISIMPLY	244	OKI	500	INCASSO CON CORNICE L	446
LIEVE	116	M-ECO	254	SIMPLY	494	INCASSO CON FILOMURO F	442
LINEA DARK	120	MIRÓ SOSP	160	S-POT	504	INCASSO FILOMURO I	430
MIRÓ H	74	MIRÓ PLAF	194			INCASSO FILOMURO N	434
OKI H	86	MIRÓ APPLIQUE	212			MULTIUSO	406
ORIZZONTE	132	OKI	310			MULTIUSO M	410
OVERLAP	104	OPERÀ	324			ORIENTABILE 360	390
OVERLAP 2.0	110	RETRO	352			PLAFONE S	402
RIFLESSA	146	SHAPE	278			VELETTA H	418
S-POT H	96	SIDE	362			VELETTA O	414
TAO	136	SIMPLY	300				
VELATA	54	S-POT	366				
		TABLET ROUND	334				
		TABLET SQUARE	344				
		TASK	356				
		MANAGEMENT SYSTEM	450				
		DRIVERS & ACCESSORIES	462				



COMPANY

AZIENDA - UNTERNEHMEN

Team Italia è un'azienda specializzata nella produzione di sistemi d'illuminazione professionali. L'azienda nasce nel 1991 con una vocazione prettamente decorativa per poi evolversi negli anni diventando all'avanguardia sia dal punto di vista tecnologico che dal punto di vista del design, della ricerca estetica e della creatività. Oggi Team Italia conta un ampio pacchetto prodotti in grado di rispondere alle più svariate e attuali applicazioni progettuali. È soprattutto dall'ascolto della propria clientela che l'azienda progetta, sviluppa e realizza prodotti in grado di fornire soluzioni innovative ed estremamente affidabili diventando un punto di riferimento per progettisti e lighting designers in Italia e nel mondo.

Team Italia is a company specialized in the manufacturing of professional lighting systems. The company was founded in 1991 with a decorative vocation and then evolved over the years becoming at the vanguard of technology, design, aesthetic research and creativity. Today Team Italia has a wide range of products to meet the various and current design applications. Especially by listening to its customers, the company designs, develops and manufactures products that provide innovative and extremely reliable solutions becoming a reference point for designers and lighting designers in Italy and in the world.

Team Italia ist ein Unternehmen, das auf die Herstellung von professionellen Beleuchtungssystemen spezialisiert ist. Das Unternehmen entstand in 1991 mit einer rein dekorativen Neigung: mit den Jahren hat es sich entwickelt um ein Vorreiter für Technologie, Design, ästhetische Forschung und Kreativität zu werden. Heute bietet Team Italia ein weites Angebot an Produkte, welche die unterschiedlichsten und aktuellsten Anwendungen trifft. Vor allem dank dem Zuhören unserer Kunden, ist das Unternehmen imstande Produkte zu entwerfen, entwickeln und verwirklichen, die eine innovative und extrem zuverlässige Lösung ergeben und ist damit in Italien und weltweit ein Anhaltspunkt für Planer und Lighting Designers geworden.

COMPANY profile

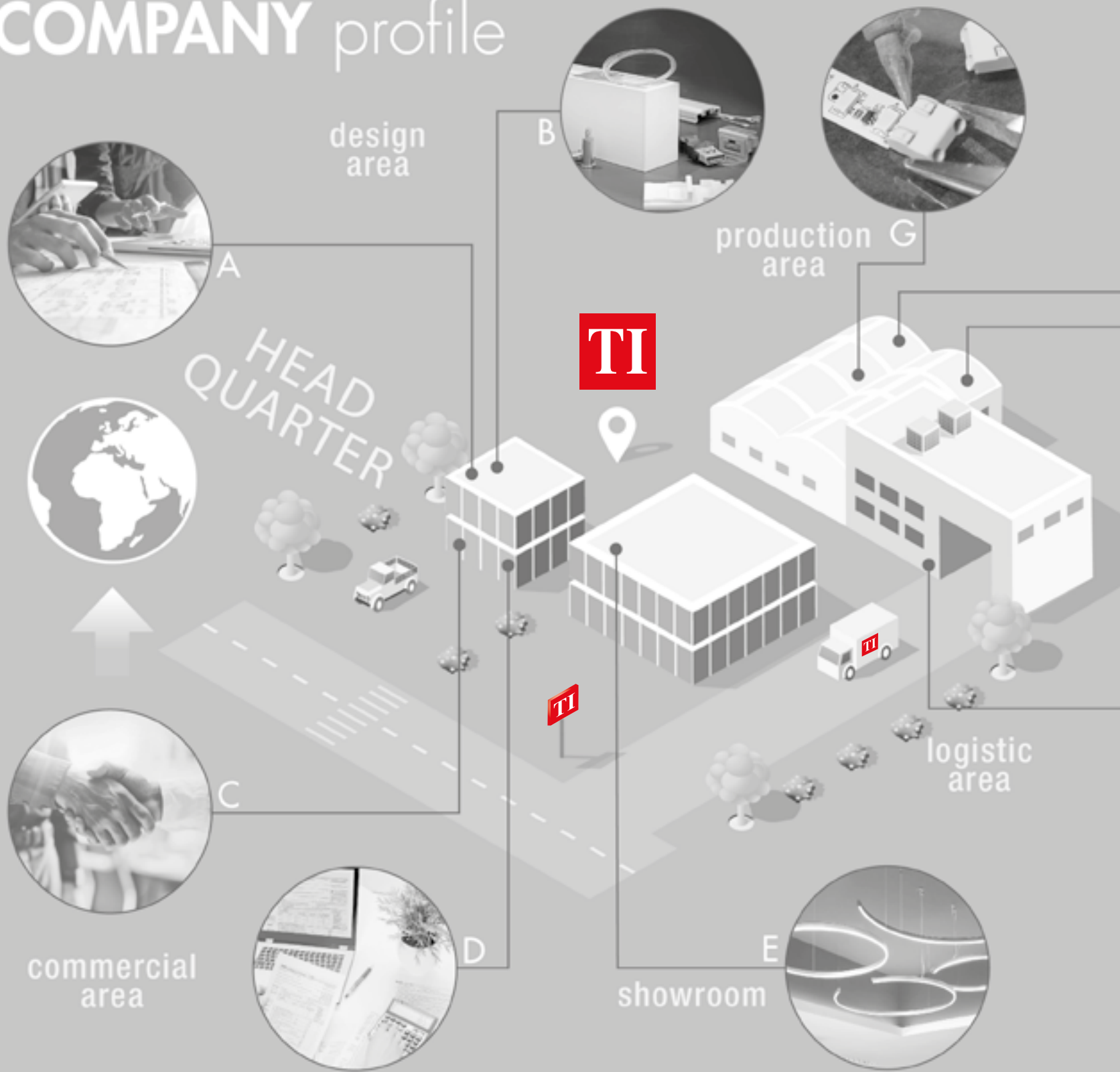

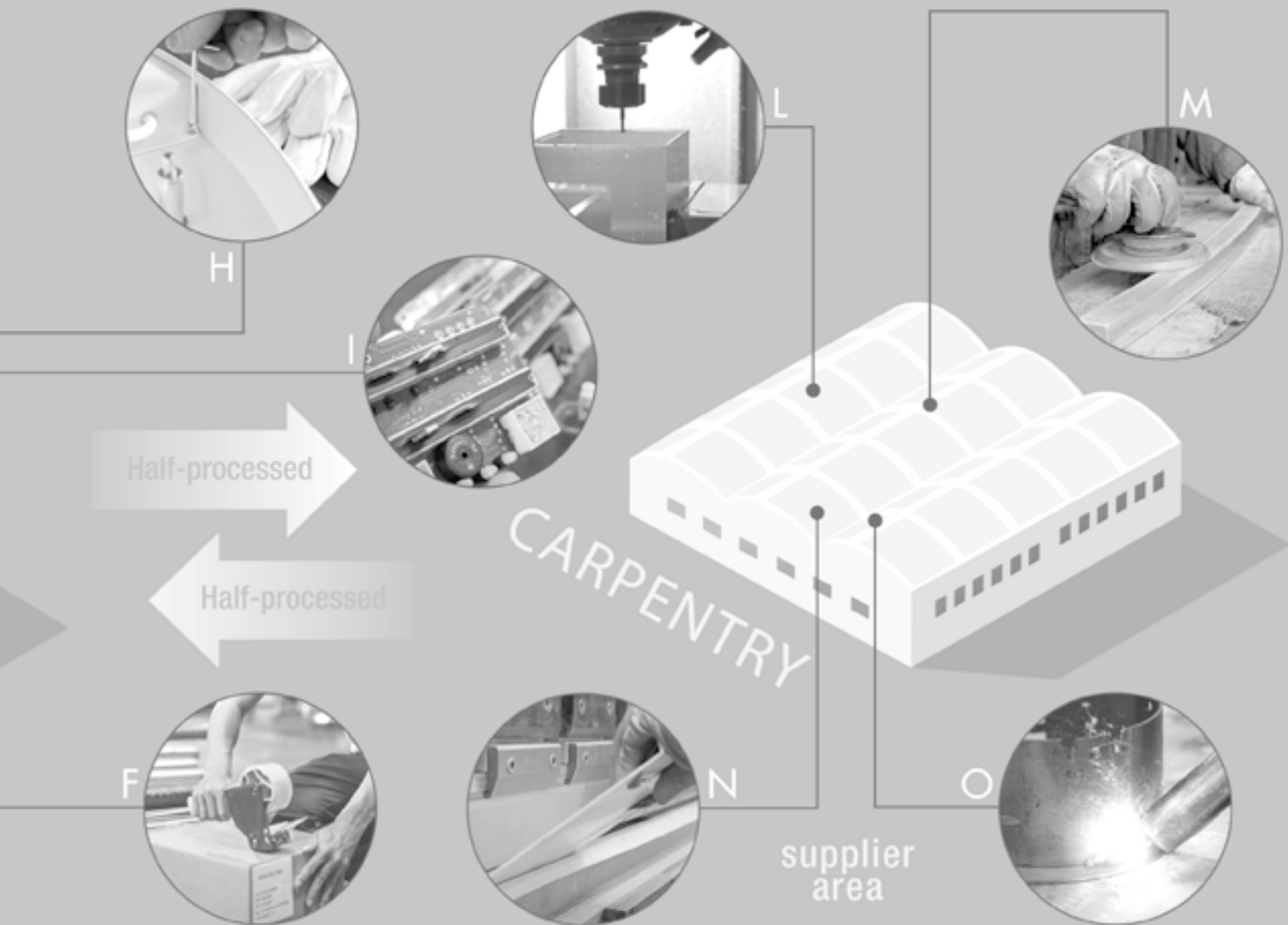

LEGEND

Design area

A. DESIGN OFFICE

B. RESEARCH & DEVELOPMENT

Commercial area

C. COMMUNICATION
AND CUSTOMERS

D. MANAGEMENT

Showroom

E. EXPOSITIONS OF FINAL
PRODUCTS

Logistic area

F. PACKAGING / SHIPPING

Production area

G. TESTER

H. PROTOTYPING

I. CUSTOMIZATION

Supplier area

L. MILLING M. POLISH

N. WELDING

O. BENDING/CALENDERING

SOSPENSIONE
Pendant Lamp
Pendelleuchte

PARETE
Wall Lamp
Wandleuchte

PLAFONE
Ceiling Lamp
Deckenleuchte

INCASSO
Recessed light
Einbauleuchte

TERRA
Floor Lamp
Stehlampe

BINARIO
Tracklight
Stromschiene

ARIELL



128

BELLAI



288



292

BELLAI HOME



40



52



46



50



44



48

BELLAI UP



298

COMPACT



142



144



SOSPENSIONE
Pendant Lamp
Pendelleuchte

PARETE
Wall Lamp
Wandleuchte

PLAFONE
Ceiling Lamp
Deckenleuchte

INCASSO
Recessed Light
Einbauleuchte

TERRA
Floor Lamp
Stehlampe

BINARIO
Tracklight
Stromschiene

E CURVE



82



84

E EDGE HOME



64



70



68

A EDGE



268



276



272



274

A EMME 24



222



228



236

SOSPENSIONE
Pendant lamp
Pendelleuchte

PARETE
Wall lamp
Wandleuchte

PLAFONE
Ceiling lamp
Deckenleuchte

INCASSO
Recessed Light
Einbauleuchte

TERRA
Floor lamp
Stehlampe

BINARIO
Tracklight
Stromschiene

LEGGERA



26



30



32



28



36



34

LIEVE



118

LINEA DARK



122

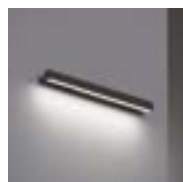

124

MICRO



318



322



320



SOSPENSIONE UP+DOWN
 Pendant lamp Up+Down
 Pendelleuchte Up+Down

SOSPENSIONE DOWN
 Pendant lamp Down
 Pendelleuchte Down

SOSPENSIONE UP
 Pendant lamp Uplight
 Pendelleuchte Up

SOSPENSIONE NON LUMINOSA
 Pendant Nonlight Element
 Pendelleuchte Blindabdeckung

PLAFONE DOWN
 Ceiling Lamp Down
 Deckenlampe Down

PLAFONE NON LUMINOSO
 Nonlight Ceiling Element
 Deckenelement Blindabdeckung

MIRÒ



164



170



176

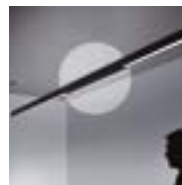

182



196



202



184



186



206



204



190

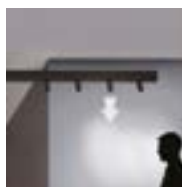

188

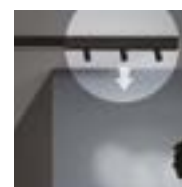

208



192



210

MIRÒ HOME



76

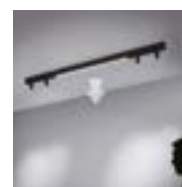

78

SOSPENSIONE
Pendant lamp
Pendelleuchte

PARETE
Wall lamp
Wandleuchte

PLAFONE
Ceiling lamp
Deckenleuchte

INCASSO
Recessed Light
Einbauleuchte

TERRA
Floor lamp
Stehlampe

BINARIO
Tracklight
Stromschiene

A **MIRÒ**
APPLIQUE



214

A **MINISIMPLY**



246



248

A **M-ECO**



256



258



262

E **OKI HOME**



88



94



90



88



92

A **OKI**



312



SOSPENSIONE
Pendant Lamp
Pendelleuchte

PARETE
Wall Lamp
Wandleuchte

PLAFONE
Ceiling Lamp
Deckenleuchte

INCASSO
Recessed Light
Einbauleuchte

TERRA
Floor Lamp
Stehlampe

BINARIO
Tracklight
Stromschiene

A OPERÀ



326



330

FE ORIZZONTE



134

FE OVERLAP



106



108

FE OVERLAP 2.0



110



114

A RETRÓ



354

SOSPENSIONE
Pendant lamp
Pendelleuchte

PARETE
Wall lamp
Wandleuchte

PLAFONE
Ceiling lamp
Deckenleuchte

INCASSO
Recessed light
Einbauleuchte

TERRA
Floor lamp
Stehlampe

BINARIO
Tracklight
Stromschiene

RIFLESSA



152



154



156

SHAPE



280



284

SIDE



364

SIMPLY

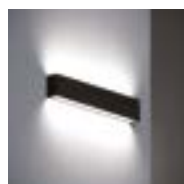

302

S-POT



368



370



376



374



372



380



SOSPENSIONE
Pendant lamp
Pendelleuchte

PARETE
Wall Lamp
Wandleuchte

PLAFONE
Ceiling Lamp
Deckenleuchte

INCASSO
Recessed Light
Einbauleuchte

TERRA
Floor Lamp
Stehlampe

BINARIO
Tracklight
Stromschiene

S-POT HOME



102



98

TABLET ROUND



336



342

TABLET SQUARE

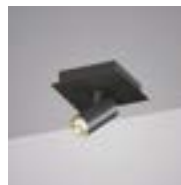

346



350

TAO



138

TASK



358



360

VELATA



58



60



56

INCASSO MURATURA
 Recessed Light Brickwork
 Einbauleuchte Mauerwerk

INCASSO CARTONGESSO
 Recessed light Plasterboard
 Einbauleuchte Gipskarton

PARETE
 Wall Lamp
 Wandleuchte

PLAFONE
 Ceiling Lamp
 Deckenleuchte

ORIENTABILE
 Adjustable
 Dreibar

A PROFILI



426



422



390



398



390



434



394



394



430



402



402



438



418



406



442



442



410



446

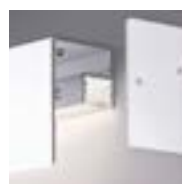

414



SOSPENSIONE
Pendant Lamp
Pendelleuchte

PARETE
Wall Lamp
Wandleuchte

PLAFONE
Ceiling Lamp
Deckenlampe

INCASSO
Recessed Light
Einbauleuchte

TERRA
Floor Lamp
Stehlampe

BIVARIO
Tracklight
Stromschiene

BELLAI



482



484

DOT



510



514

DROP



488

FLIP

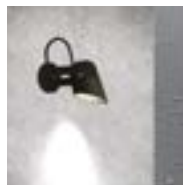

522



520



524



SOSPENSIONE
Pendant Lamp
Pendelleuchte

PARETE
Wall Lamp
Wandleuchte

PLAFONE
Ceiling Lamp
Deckenlampe

INCASSO
Recessed Light
Einbauleuchte

TERRA
Floor Lamp
Stehlampe

BINARIO
Tracklight
Stromschiene

LEGGERA



474



476



478

OKI



502

SIMPLY



496

S-POT



506

A WALL
LIGHT
CONTROL



452

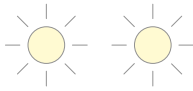

454



454



456

A SMARTDIM



456



460

A BLUETOOTH



458



A ACCESSORIES



468



468

A BOXES FOR DRIVERS

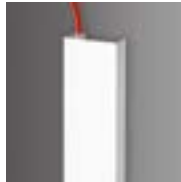

464

A POWER SUPPLIES



466

Spazio alle emozioni: la linea Home è progettata per valorizzare gli spazi della tua casa, in equilibrio tra funzionalità, design e comfort assoluto. Esprimi il tuo stile, scegli la giusta illuminazione per vivere tutti i tuoi momenti.

Space to emotions: the Home collection is designed to enhance the space of your home, balancing functionality, design and absolute comfort. Express your style, choose the right illumination to live all your moments.

Raum für Emotionen: Die Home-Linie wurde entwickelt, um die Räume Ihres Hauses aufzuwerten, mittels eines guten Gleichgewichtes zwischen Funktionalität, Design und absoluten Komfort. Drücken Sie Ihren Stil aus und wählen Sie die richtige Beleuchtung, um schöne alle Ihre Momente im richtigen zu erleben.

HOME







 
MADE in ITALY

Esile anello luminoso a luce diffusa la cui forma leggermente socchiusa consente la realizzazione di suggestive aggregazioni luminose. Disponibile nelle nuove eleganti finiture verniciate oro, rame e bronzo. L'alimentatore è contenuto nel rosone.

Slight lighting ring with diffused light; its slightly ajar shape allows the creation of suggestive bright aggregations. Available in the new elegant varnished finishes: gold, copper and bronze. The power supply is contained in the ceiling rose.

Dünnes Leuchtring mit diffusem aus diffuses Licht: die leichte halbgeöffnete Form erlaubt die Realisierung von faszinierenden Beleuchtung Zusammensetzungen. In den neuen Gold, Kupfer, Bronze Lackierungen erhältlich. Das Netzteil ist in der Rosette erhalten.





LEGGERA



LEGGERA

Versione Stand-Alone a sospensione disponibile in quattro misure nelle finiture standard oro, rame e bronzo o speciali, ideale per applicazioni in ambito residenziale. L'alimentatore è remoto all'interno del rosone.

Stand-Alone suspension lamp "Leggera" is available in four sizes in standard finishes gold, copper and bronze varnishings or special ones. Ideal for residential environments. The power supply is remotely included in the ceiling rose.

Stand-Alone Pendelleuchte in vier Maßen und in den Standardausführungen Gold, Kupfer und Bronze verfügbar. Ideal für die Anwendung in häuslichen Räume. Das Fern-Netzteil ist in der Rosette erhalten.

1032AOF

35W 1450lm* - 220V

1032ADM

DALI (Push) - 35W 1450lm - 220V

1032ATF

35W 1450lm - 220V

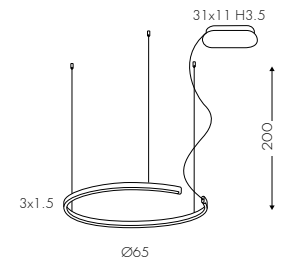

1032BOF

48W 2150lm - 220V

1032BDM

DALI (Push) - 48W 2150lm - 220V

1032BTF

48W 2150lm - 220V

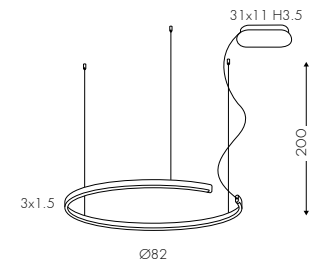

1032COF

65W 2750lm - 220V

1032CDM

DALI (Push) - 65W 2750lm - 220V

1032CTF

65W 2750lm - 220V

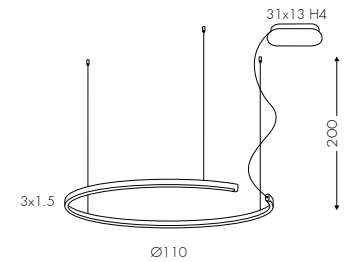

1032DOF

90W 4150lm - 220V

1032DDM

DALI (Push) - 90W 4150lm - 220V

1032DTF

90W 4150lm - 220V

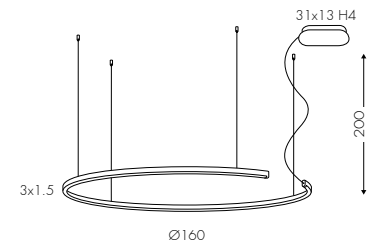

A E2 Opale - Opal

A 2700K

B 3000K

BV **NE** **RV** **BR** **OV**

TF Taglio di Fase - Phase-Cut Dimmer - Phasenabschrittdimmer

A Alimentatore nel rosone - Power Supply inside the ceiling rose - Netzteil in der Deckendose

Esempio - Example - Beispiel *

1450lm con - with - mit **E2**







1032ABOF
1032ABDM
1032ABTF

83W 3600lm* - 220V
 DALI (Push) - 83W 3600lm - 220V
 83W 3600lm - 220V

1032ABCOF
1032ABCDM
1032ABCTF

148W 6350lm - 220V
 DALI (Push) - 148W 6350lm - 220V
 148W 6350lm - 220V

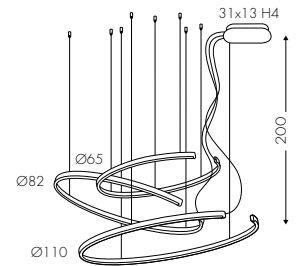
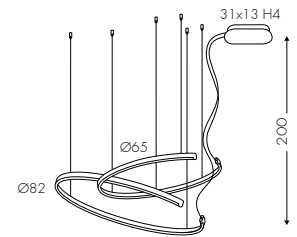

A E2 Opale - Opal

A 2700K

B 3000K

BV **NE** **RV** **BR** **OV**



TF Taglio di Fase - Phase-Cut Dimmer - Phasenabschrittdimmer

A Alimentatore nel rosone - Power Supply inside the ceiling rose - Netzteil in der Deckendose

Esempio - Example - Beispiel *

3600lm con - with - mit **E2**







LEGGERA

Versione da parete e plafone disponibile in tre misure nelle finiture standard come il bianco o il nero, o speciali come oro, rame, bronzo. Ideale per applicazioni in ambito residenziale. L'alimentatore è remoto all'interno del rosone.

Wall light and ceiling light available in three standard sizes with standard finishes black or white, or special ones like gold, copper, and bronze. Ideal for residential use. The power supply is included remotely in the ceiling rose.

Wandleuchte und Deckenleuchte in drei Größen erhältlich mit Standard-Farben Weiß oder Schwarz oder speziellen wie Gold, Kupfer, Bronze. Ideal für Wohnanwendungen. Das Netzteil ist in der Rosette erhalten.



2032COF
2032CDM
2032CTF

25W 1050lm* - 220V
DALI (Push) - 25W 1050lm - 220V
25W 1050lm - 220V

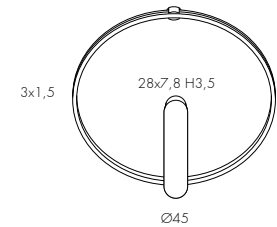

2032AOF
2032ADM
2032ATF

35W 1450lm - 220V
DALI (Push) - 35W 1450lm - 220V
35W 1450lm - 220V

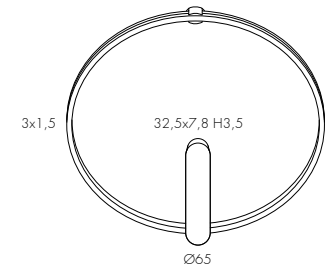

2032BOF
2032BDM
2032BTF

48W 2150lm - 220V
DALI (Push) - 48W 2150lm - 220V
48W 2150lm - 220V

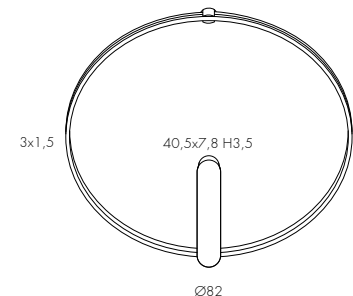

CE IP20 **A** E2 Opale - Opal

A 2700K

B 3000K

BV **NE** **RV** **BR** **OV**

TF Taglio di Fase - Phase-Cut Dimmer - Phasenabschrittdimmer

A Alimentatore Incorporato - Incorporated Power Supply - Eingebautes Netzteil

Esempio - Example - Beispiel *
1050lm con - with - mit **E2**







LEGGERA

Soluzione a plafone alternativa; il corpo principale, staccandosi lievemente dal plafone, cattura l'attenzione diventando un prezioso elemento d'arredo garantendo inoltre un maggior risalto luminoso all'area sottostante.

Alternative ceiling lamp solution; the main body, moving away slightly from the ceiling, captures attention and becomes a precious furnishing element improving moreover the brightness of the area below.

Alternative Deckenleuchte Lösung; der Hauptkörper, der sich leicht von der Decke löst, zieht die Aufmerksamkeit auf sich und wird somit zu einem wertvollen Einrichtungselement, das zugleich der darunter liegenden Zone eine größere Leuchtkraft verleiht.

3032AOF

35W 1450lm* - 220V

3032ADM

DALI (Push) - 35W 1450lm - 220V

3032ATF

35W 1450lm - 220V

3032BOF

48W 2150lm - 220V

3032BDM

DALI (Push) - 48W 2150lm - 220V

3032BTF

48W 2150lm - 220V

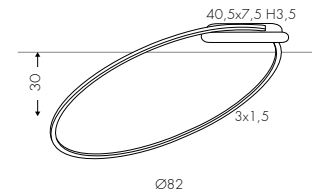
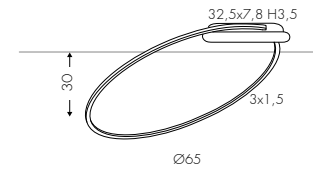

● A 2700K

● B 3000K

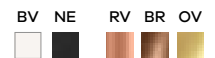
**TF** Taglio di Fase - Phase-Cut Dimmer - Phasenabschrittdimmer**A** Alimentatore Incorporato - Incorporated Power Supply - Eingebautes Netzteil

Esempio - Example - Beispiel *

1450lm con - with - mit **E2**





3032ABOF

83W 3600lm* - 220V

3032ABDM

DALI (Push) - 83W 3600lm - 220V

3032ABTF

83W 3600lm - 220V

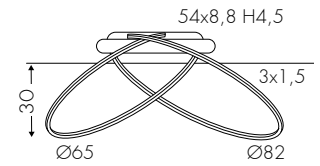

A E2 Opale - Opal

A 2700K

B 3000K

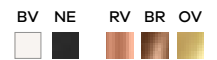

TF Taglio di Fase - Phase-Cut Dimmer - Phasenabschrittdimmer

A Alimentatore Incorporato - Incorporated Power Supply - Eingebautes Netzteil

Esempio - Example - Beispiel *

3600lm con - with - mit **E2**







LEGGERA

Sinuosa soluzione a parete/plafone per un'illuminazione delicata, lineare e diffusa. L'alimentatore remoto offre l'opportunità di collocare il prodotto in modo svincolato dalla posizione del punto luce.

Versatile wall/ceiling lamp solution for a soft, linear and diffused lighting. The remote power supply offers the opportunity to place the product unconstrained by the position of the power point.

Eine Schlangenlinie Wand- oder Deckenlösung für eine feine, lineare und diffuse Beleuchtung. Das Fern-Netzteil bietet die Möglichkeit, das Produkt unabhängig von der Position des Lichtpunktes zu positionieren.

3032GOF

35W 1450lm* - 220V

3032GDM

DALI (Push) - 35W 1450lm - 220V

3032GTF

35W 1450lm - 220V

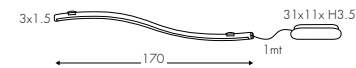

A E2 Opale - Opal

A 2700K

B 3000K



TF Taglio di Fase - Phase-Cut Dimmer - Phasenabschrittdimmer

A Alimentatore nel rosone - Power Supply inside the ceiling rose - Netzteil in der Deckendose

Esempio - Example - Beispiel *

1450lm con - with - mit **E2**







 
MADE in ITALY

38

Anello luminoso dalle dimensioni contenute ideato per garantire eccezionali rese cromatiche anche in ambito residenziale.

Lighting ring with small dimensions designed to guarantee exceptional luminous yields even in residential use.

Leuchtender Ring mit geringen Ausmaßen entwickelt um außergewöhnliche Lichtleistungen auch im Wohngebiet zu versichern.





**BELLAI
HOME**



BELLAI HOME

Anello luminoso dalle dimensioni contenute per applicazioni in ambito residenziale. L'alimentatore incluso è posizionato nel rosone.

Lighting ring with small dimensions for residential use. The power supply is included in the ceiling rose.

Leuchtender Ring mit geringen Ausmaßen für Wohnanwendung. Der Netzteil ist in der Deckenrosette enthalten.

1027EOF

42W 3247lm* + 24W 2400lm - 220V

1027EDM

DALI (Push) - 42W 3247lm + 24W 2400lm - 220V

1027ETF

42W 3247lm + 24W 2400lm - 220V

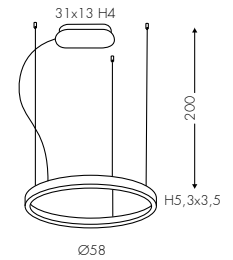

1027AOF

50W 3808lm + 24W 2400lm - 220V

1027ADM

DALI (Push) - 50W 3808lm + 24W 2400lm - 220V

1027ABT

50W 3808lm + 24W 2400lm - 220V

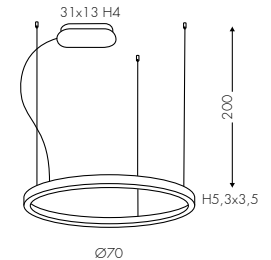

1027BOF

65W 5168lm + 24W 2400lm - 220V

1027BDM

DALI (Push) - 65W 5168lm + 24W 2400lm - 220V

1027BBT

65W 5168lm + 24W 2400lm - 220V

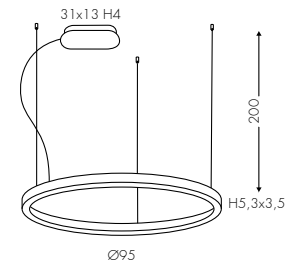

VA003E

Variazione: sostituzione con rosone centrale Ø30cm
Variation: substitution with central ceiling rose Ø30cm
Variante: Ersatz durch zentrale Deckenrose Ø30cm

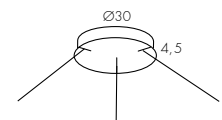

BR

CUSTOM



A E2 Opale - Opal

A 2700K

B 3000K

BV NE RU SO

TF Taglio di Fase - Phase-Cut Dimmer - Phasenabschnittdimmer

A Alimentatore nel rosone - Power Supply inside the ceiling rose - Netzteil in der Deckendose

BT Bluetooth - Bluetooth - Bluetooth

Esempio - Example - Beispiel *

3247lm con - with - mit **E2**







1027COF
1027CDM
1027CBT

92W 7352lm* + 29W 3600lm - 220V
DALI (Push) - 92W 7352lm + 29W 3600lm - 220V
92W 7352lm + 29W 3600lm - 220V

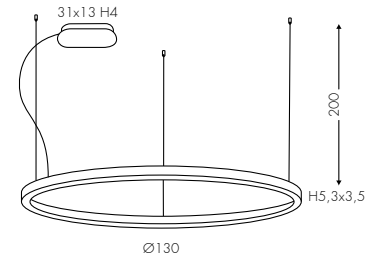

1027DOF
1027DDM

110W 8755lm + 35W 5250lm - 220V
DALI (Push) - 110W 8755lm + 35W 5250lm - 220V

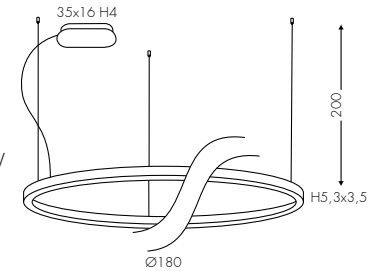

VA003E

Variazione: sostituzione con rosone centrale Ø30cm
Variation: substitution with central ceiling rose Ø30cm
Variante: Ersatz durch zentrale Deckenrose Ø30cm

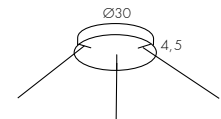

A E2 Opale - Opal

A 2700K

B 3000K

BV **NE** **RU** **SO**

TF Taglio di Fase - Phase-Cut Dimmer - Phasenabschnittdimmer

A Alimentatore nel rosone - Power Supply inside the ceiling rose - Netzteil in der Deckendose

BT Bluetooth - Bluetooth - Bluetooth

Esempio - Example - Beispiel *

7352lm con - with - mit **E2**







1027AEOF
1027AEDM
1027AEBT

92W 7055lm* + 48W 4800lm - 220V
 DALI (Push) - 92W 7055lm + 48W 4800lm - 220V
 92W 7055lm + 48W 4800lm - 220V

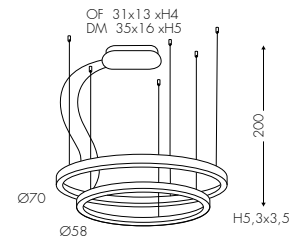

1027BEOF
1027BEDM
1027BEBT

115W 9350lm + 48W 4800lm - 220V
 DALI (Push) - 115W 9350lm + 48W 4800lm - 220V
 115W 9350lm + 48W 4800lm - 220V

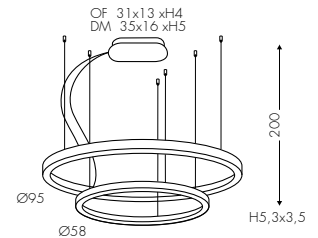

OV
 CUSTOM



A E2 Opale - Opal

A 2700K **B** 3000K

BV NE RU SO

A Alimentatore nel rosone - Power Supply inside the ceiling rose - Netzteil in der Deckendose
BT Bluetooth- Bluetooth - Bluetooth

Esempio - Example - Beispiel *
 7055lm con - with - mit **E2**







BELLAI HOME

Anello luminoso dotato di un braccio che permette di distanziare la struttura dal soffitto ed ottenere un'emissione diretta ed indiretta. Alimentatore incluso nel rosone.

Lighting ring equipped with an arm that allows distancing the structure from the ceiling and obtaining direct and indirect light emission. The power supply is included in the ceiling rose.

Leuchtender Ring mit Ausleger ausgestattet, das erlaubt die Struktur von der Decke zu Distanzieren um eine direkte und indirekte Lichtausstrahlung zu erhalten. Der Netzteil ist in der Deckenrose enthalten.

3027DOF
3027DDM
3027DTF

42W 3247lm* + 15.4W 1300lm - 220V
DALI (Push) 42W 3247lm + 15.4W 1300lm - 220V
42W 3247lm + 15.4W 1300lm - 220V

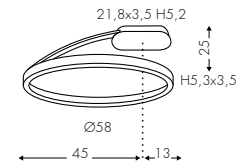

3027AOF
3027ADM
3027ABT

50W 3808lm + 24W 2400lm - 220V
DALI (Push) - 50W 3808lm + 24W 2400lm - 220V
50W 3808lm + 24W 2400lm - 220V

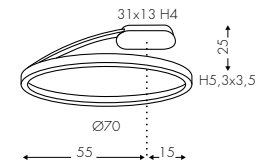

3027BOF
3027BDM
3027BBT

65W 5168lm + 24W 2400lm - 220V
DALI (Push) - 65W 5168lm + 24W 2400lm - 220V
65W 5168lm + 24W 2400lm - 220V

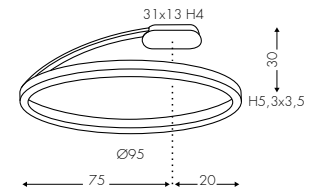

TO
CUSTOM



A E2 Opale - Opal

A 2700K

B 3000K

BV NE RU SO

TF Taglio di Fase - Phase-Cut Dimmer - Phasenabschnittdimmer

A Alimentatore nel rosone - Power Supply inside the ceiling rose - Netzteil in der Deckendose

BT Bluetooth- Bluetooth - Bluetooth

Esempio - Example - Beispiel *
3247lm con - with - mit **E2**







BELLAI HOME

Versione plafoniera con doppio fondo ed alimentatore integrato nel corpo lampada.

Ceiling light version with a double-bottom and integrated power supply in the body of the lamp.

Die Deckenleuchte Ausführung hat ein Doppelboden und ein integriertes Netzteil im Lampenkörper.



3027EOF

45W 3230lm* - 220V

3027EDM

DALI (Push) - 45W 3230lm - 220V

3027ETF

45W 3230lm - 220V



3027COF

50W 3808lm - 220V

3027CDM

DALI (Push) - 50W 3808lm - 220V

3027CBT

50W 3808lm - 220V



3027FOF

65W 5168lm - 220V

3027FDM

DALI (Push) - 65W 5168lm - 220V

3027FBT

65W 5168lm - 220V

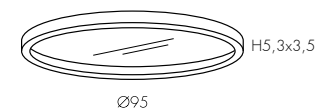

A E2 Opale - Opal

A 2700K **B** 3000K



TF Taglio di Fase - Phase-Cut Dimmer - Phasenabschnittdimmer

A Alimentatore Incorporato - Incorporated Power Supply - Eingebautes Netzteil

BT Bluetooth - Bluetooth - Bluetooth

Esempio - Example - Beispiel *

3230lm con - with - mit **E2**







BELLAI HOME

Controcassa per cartongesso in alluminio progettata per l'inserimento a raso del prodotto Bellai Home nelle misure $\varnothing 58$ e $\varnothing 95$ cm.

Aluminium outer casing for plasterboard, designed for the installation of Bellai Home in the measures 58cm and 95cm.

Aluminium-Gehäuse für Gipskarton, konzipiert für die Installation von Bellai Home in den Maßen 58cm und 95cm.

9027E

compatibile con/compatible with/ kompatibel mit **3027E**

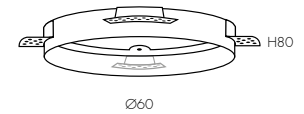

9027F

compatibile con/compatible with/ kompatibel mit **3027F**

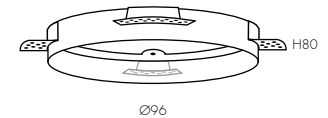





2027AOF
2027ADM
2027ATF

15W 1600lm* + 15W 1600lm - 220V
 DALI (Push) - 15W 1600lm + 15W 1600lm - 220V
 15W 1600lm + 15W 1600lm - 220V

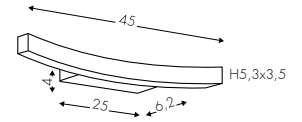

2027BOF
2027BDM

20W 2125lm + 20W 2125lm - 220V
 DALI (Push) - 20W 2125lm + 20W 2125lm - 220V

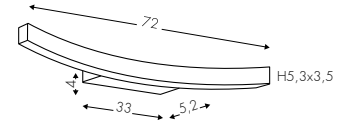

A E28 Satinato - Frosted
 Satinert

A 2700K **B** 3000K



TF Taglio di Fase - Phase-Cut Dimmer - Phasenabschnittdimmer
A Alimentatore Incorporato - Incorporated Power Supply - Eingebautes Netzteil

Esempio - Example - Beispiel *
 1600lm con - with - mit **E28**







 
MADE in ITALY

Uno scenario di luce morbida, priva di ombre e piacevolmente "velata" dalla sagoma del corpo illuminante è l'effetto che questa famiglia di prodotto diffonde nell'ambiente. Il corpo lampada nelle sue preziose finiture e il delicato effetto controluce che esso crea arricchisce l'ambiente e lo completa con semplicità.

A scenario of soft light, without shadows and pleasantly "veiled" by the shape of the lighting body is the effect that this family of product diffuses in the environment. The lamp body with its precious finishes and the delicate backlighting effect it creates enriches the environment and completes it with simplicity.

Diese Produktfamilie verbreitet ein weiches Licht in der Umgebung, ohne Schatten, angenehm gedämpft durch die Form des Beleuchtungskörpers. Der Lampenkörper, mit seinen kostbaren Feinarbeiten und derartigen Hintergrundbeleuchtung die er erzeugt, bereichert die Umgebung und ergänzt sie mit Einfachheit.



The image features a minimalist design with a warm color palette. The background is split into two horizontal sections: a lighter orange top and a darker red bottom. A white vertical line runs through the center, starting from a small white rectangular block at the top and ending at a white circular shape at the bottom. To the left of this line, a white curved line loops around it. The word "VELATA" is printed in a bold, white, sans-serif font across the boundary between the two background colors.

VELATA



VELATA

Lampada ad emissione luminosa indiretta in alluminio verniciato a polveri.
Alimentatore incorporato.

Indirect light emission lamp in powder coated aluminum. Incorporated power supply.

Lampe mit indirekter Lichtausstrahlung aus pulverlackiertem Aluminium.
Eingebautes Netzteil.



3038AOF
3038ADM
3038ATF

25W 3700lm* - 220V
DALI (Push) - 25W 3700lm - 220V
25W 3700lm - 220V

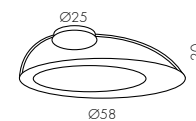

3038BOF
3038BDM
3038BTF

50W 6400lm - 220V
DALI (Push) - 50W 6400lm - 220V
50W 6400lm - 220V

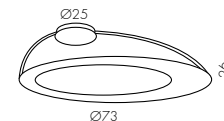

3038COF
3038CDM
3038CBT

75W 7800lm - 220V
DALI (Push) - 75W 7800lm - 220V
75W 7800lm - 220V

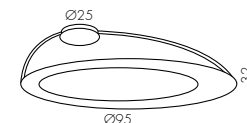

E28 Satinato - Frosted
Satinert



A 2700K



B 3000K



BV **NE** **RV** **BR** **OV**

TF Taglio di Fase - Phase-Cut Dimmer - Phasenabschnittdimmer

A Alimentatore Incorporato - Incorporated Power Supply - Eingebautes Netzteil

BT Bluetooth- Bluetooth - Bluetooth

Esempio - Example - Beispiel *

3700lm con - with - mit **E28**







1038AOF 25W 3700lm* - 220V
1038ADM DALI (Push) - 25W 3700lm - 220V
1038ATF 25W 3700lm - 220V

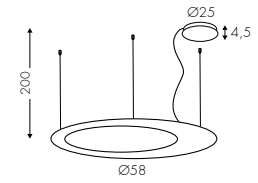

1038BOF 50W 6400lm - 220V
1038BDM DALI (Push) - 50W 6400lm - 220V
1038BTF 50W 6400lm - 220V

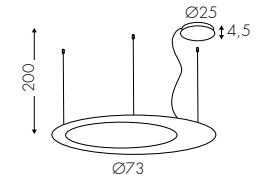

1038COF 75W 7800lm - 220V
1038CDM DALI (Push) - 75W 7800lm - 220V
1038CBT 75W 7800lm - 220V

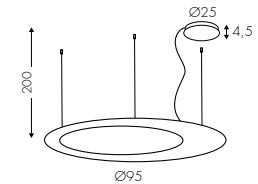

VA003E Variazione: sostituzione con rosone centrale Ø30cm
 Variation: substitution with central ceiling rose Ø30cm
 Variante: Ersatz durch zentrale Deckenrose Ø30cm

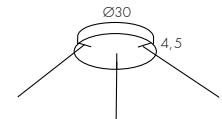

E28 Satinato - Frosted
 Satinert



A 2700K



B 3000K

BV

NE

RV

BR

OV



TF Taglio di Fase - Phase-Cut Dimmer - Phasenabschnittdimmer

A Alimentatore nel rosone - Power Supply inside the ceiling rose - Netzteil in der Deckendose

BT Bluetooth- Bluetooth - Bluetooth

Esempio - Example - Beispiel *

3700lm con - with - mit **E28**







2038AOF 15W 1900lm* - 220V
2038ADM DALI (Push) - 15W 1900lm - 220V
2038ATF 15W 1900lm - 220V

2038BOF 18W 2600lm - 220V
2038BDM DALI (Push) - 18W 2600lm - 220V
2038BTF 18W 2600lm - 220V

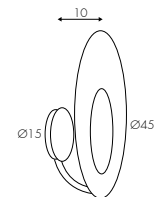
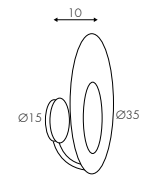

E28 Satinato - Frosted
Satinert



A 2700K



B 3000K

BV



NE RV BR OV



TF Taglio di Fase - Phase-Cut Dimmer - Phasenabschnittdimmer

A Alimentatore Incorporato - Incorporated Power Supply - Eingebautes Netzteil

Esempio - Example - Beispiel *
 1900lm con - with - mit **E28**





 
MADE in ITALY

62

Collezione di apparecchi dalla forma geometrica semplice e regolare. Emissione luminosa potente, diffusa con diffusore opale ideale in ambito residenziale.

Collection of lamps with a simple and regular geometric shape and powerful light emission. Diffused light with opal diffuser for residential use.

Leuchtensammlung mit leichter und regelmäßiger geometrischer Form und starker Lichtemission. Lichtleistung mit opal-Diffusor für die Wohnbeleuchtung.





EDGE H



EDGE HOME COMPOSIZIONE

Composizione a sospensione dalla forma semplice e regolare, quadrata e rettangolare, con emissione luminosa downlight e uplight diffusa con diffusore opale. Alimentatore incluso nel rosone.

Suspension lamp composition with a simple and regular shape, squared and rectangular, with down and up light emission through opal diffuser. The power supply is included in the ceiling rose.

Zusammensetzung aus Pendelleuchten mit einer einfachen und regelmäßigen Form, vier- und rechteckig, mit diffuser Downlight und Uplight Lichtleistung mit opal-Diffusor. Das Netzteil ist in der Rosette erhalten.

1028NOF
1028NDM
1028NBT

62W 5363lm* + 50W 4290lm - 220V
DALI (Push) - 62W 5363lm + 50W 4290lm - 220V
62W 5363lm + 50W 4290lm - 220V

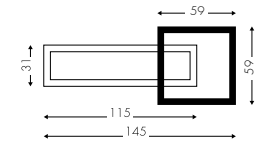
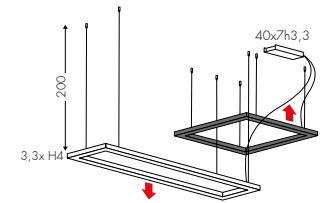

1028MOF
1028MDM
1028MBT

75W 6435lm + 44W 3880lm - 220V
DALI (Push) - 75W 6435lm + 44W 3880lm - 220V
75W 6435lm + 44W 3880lm - 220V

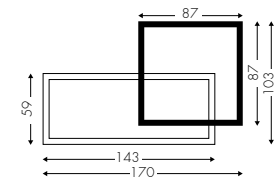
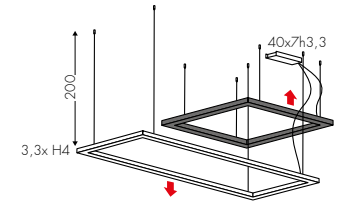

CE IP20 A E2 Opale - Opal

A 2700K B 3000K

BV NE BN

BT Bluetooth - Bluetooth - Bluetooth

A Alimentatore nel rosone - Power Supply in the ceiling rose - Netzteil in der Deckendose

Esempio - Example - Beispiel *
5363lm con - with - mit **E2**







1028OOF

96W 8181lm* + 35W 2964lm - 220V

1028ODM

DALI (Push) - 96W 8181lm + 35W 2964lm - 220V

1028OBT

96W 8181lm + 35W 2964lm - 220V

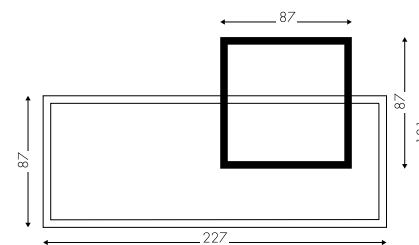
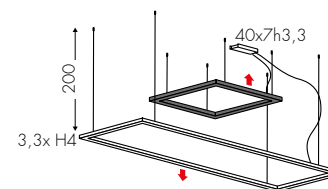

A E2 Opale - Opal

A 2700K **B** 3000K



BT Bluetooth - Bluetooth - Bluetooth

A Alimentatore nel rosone - Power Supply in the ceiling rose - Netzteil in der Deckendose

Esempio - Example - Beispiel *

8181lm con - with - mit **E2**







EDGE

Lampada a plafone dalla forma semplice e regolare, quadrata o rettangolare, con emissione luminosa downlight diffusa con diffusore opale. Alimentatore incorporato.

Ceiling lamp with a simple and regular shape. Square or rectangular, made with a downlight emission filtered by a opal Built-in power supply.

Deckenleuchte mit einfacher und gleichmäßiger Form. Quadratische oder rechteckige Form, mit einer down Lichtausstrahlung, die durch einen opalen. Eingebautes Netzteil.



3028IOF
3028IDM

50W 3647lm* - 220V
DALI (Push) - 50W 3647lm - 220V

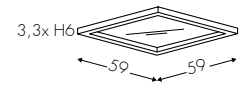

3028EOF
3028EDM

62W 4558lm - 220V
DALI (Push) - 62W 4558lm - 220V

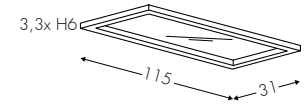

A E2 Opale - Opal

A 2700K

B 3000K



Alimentatore Incorporato - Incorporated Power Supply - Eingebautes Netzteil

Esempio - Example - Beispiel *
3647lm con - with - mit **E2**



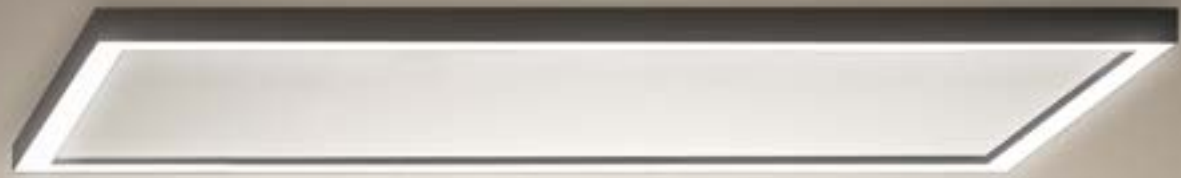



EDGE

Lampada da parete con angolo a 90° ed emissione luminosa verso il basso.
Alimentatore incorporato.

Wall light with a 90° corner and downlight emission.
Integrated Power supply

Wandleuchte mit 90 Grad Winkel, Downlight Emission.
Mit integriertem Netzteil.

2028AOF

9W 977lm* - 220V

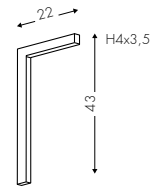

A E2 Opale - Opal

A 2700K

B 3000K



Alimentatore Incorporato - Incorporated Power Supply - Eingebautes Netzteil

70

indice
fotografico



Esempio - Example - Beispiel *
977lm con - with - mit **E2**





2028GOF
2028GDM

34W 2490lm* - 220V
DALI (Push) - 34W 2490lm - 220V

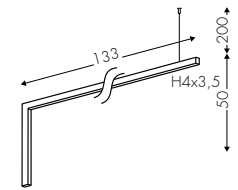

2028EOF
2028EDM

51W 3740lm - 220V
DALI (Push) - 51W 3740lm - 220V

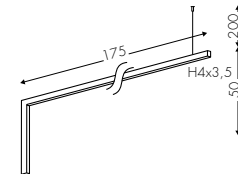

2028FOF
2028FDM

51W 3740lm - 220V
DALI (Push) - 51W 3740lm - 220V

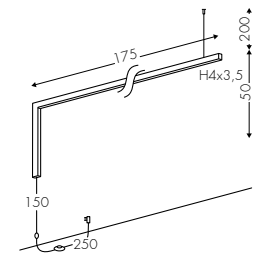

A E2 Opale - Opal

A 2700K

B 3000K



Alimentatore Incorporato - Incorporated Power Supply - Eingebautes Netzteil







 
MADE in ITALY

74

La famiglia Mirò Home raccoglie
in singoli codici pronto-uso le
poliedriche qualità proprie delle
composizioni del sistema Mirò.

The Mirò Home family collects
in single ready-to-use codes the
multifaceted qualities
of Mirò system compositions.

Die Home Mirò Familie sammelt
die vielfältigen Qualitäten der
Mirò-Systemkompositionen
und macht sie in einzelne
gebrauchsfertige Coden.





MIRÓ HOME



MIRÓ HOME

Apparecchio con emissione luminosa diretta, indiretta ed orientabile a luce concentrata grazie agli spot integrati. Disponibile nelle varianti On/Off o dimmerabile DALI (Push).

Lamp with concentrated direct, indirect and adjustable down light emission thanks to the integrated spot lights. Available in On/Off or dimmable DALI (Push) versions.

Pendelleuchte mit direkter und einstellbarer Lichtemission mit konzentriertem Licht durch das integriertes Spot Licht. On/Off oder dimmbar DALI (Push) Ausführungen sind erhältlich.



1030D11OF

Spot 2x7W 2x680lm -
44W 3761lm* + 18W 2390lm - 220V

1030D11DM

DALI (Push) - Spot 2x7W 2x680lm
44W 3761lm + 18W 2390lm - 220V

1030F22OF

Spot 4x7W 4x680lm
53W 4513lm + 18W 2390lm - 220V

1030F22DM

DALI (Push) - Spot 4x7W 4x680lm
53W 4513lm + 18W 2390lm - 220V

1030H22OF

Spot 4x7W 4x680lm
70W 6020lm + 18W 2390lm - 220V

1030H22DM

DALI (Push) - Spot 4x7W 4x680lm
70W 6020lm + 18W 2390lm - 220V

UPLIGHT - DOWNLIGHT

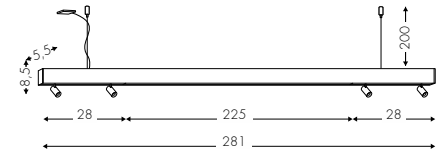
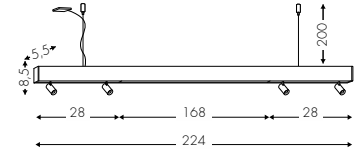
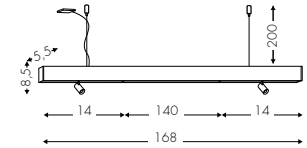

A

+ E2 Opale - Opal
24° Ottica - Optic - Optik

B 3000K



A Alimentatore Incorporato - Incorporated Power Supply - Eingebautes Netzteil

Esempio - Example - Beispiel *
3761lm con - with - mit **E2**







MIRÓ HOME

Apparecchio con emissione luminosa diretta, e orientabile a luce concentrata grazie agli spot integrati. Disponibile nelle varianti On/Off o dimmerabile DALI (Push).

Lamp with concentrated direct and adjustable down light emission thanks to the integrated spot lights. Available in On/Off or dimmable DALI (Push) versions.

Pendelleuchte mit direkter und einstellbarer Lichtemission mit konzentriertem Licht durch das integriertes Spot Licht. On/Off oder dimmbar DALI (Push) Ausführungen sind erhältlich.

**3030A11OF**

Spot 2x7W 2x680lm - 18W 1770lm* - 220V

3030A11DM

DALI (Push) - Spot 2x7W 2x680lm - 18W 1770lm - 220V

3030C11OF

Spot 2x7W 2x680lm - 35W 3009lm - 220V

3030C11DM

DALI (Push) - Spot 2x7W 2x680lm - 35W 3009lm - 220V

3030F22OF

Spot 4x7W 4x680lm - 53W 4513lm - 220V

3030F22DMDALI (Push) - Spot 4x7W 4x680lm
53W 4513lm - 220V**3030H22OF**

Spot 4x7W 4x680lm - 70W 6020lm - 220V

3030H22DMDALI (Push) - Spot 4x7W 4x680lm
70W 6020lm - 220V

DOWNLIGHT

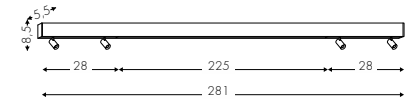
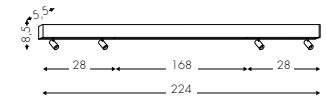
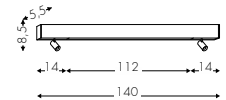
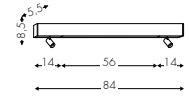

+ E2 Opale - Opal
24° Ottica - Optic - Optik



A Alimentatore Incorporato - Incorporated Power Supply - Eingebautes Netzteil

Esempio - Example - Beispiel *
1770lm con - with - mit **E2**







 
MADE in ITALY

Forme sinuose che disegnano curve luminose per creare un ambiente esclusivo ed originale. Curve si distingue anche per dimensioni ridotte grazie alla tecnologia led adottata per questa famiglia.

Sinuous shapes that draw bright suspended curves to create an exclusive and original environment. Curve is also distinguished by its small size thanks to the led technology adopted for this family of products.

Gewundene Formen, die helle Kurven zeichnen, um eine exklusive und originelle Innenraumumgebung zu schaffen. Curve unterscheidet sich auch für die verringerte Ausmaßen, dank der für diese Produktfamilie angenommenen Led-Technologie.





CURVE



CURVE

Lampada curvilinea a sospensione con sorgente a led. Diffusore opale a emissione luminosa diretta. Alimentatore incluso nel rosone.

Curved suspension lamp with led light source. Opal diffuser with direct light emission. The power supply is included in the ceiling rose.

Kurvenförmige Pendelleuchte mit Led-Lichtquelle. Opal Diffusor mit direkter Lichtemission. Das Netzteil ist in der Rosette enthalten.

1022NOF 35W 3570lm* - 220V
1022NDM DALI (Push) - 35W 3570lm - 220V
1022NTF 35W 3570lm - 220V

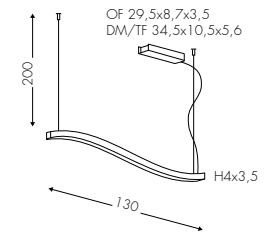

1022MOF 45W 4675lm - 220V
1022MDM DALI (Push) - 45W 4675lm - 220V
1022MTF 45W 4675lm - 220V

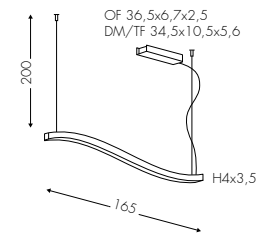

1022HOF 70W 7565lm - 220V
1022HDM DALI (Push) - 70W 7565lm - 220V

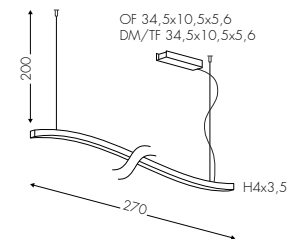

A E2 Opale - Opal

A 2700K

B 3000K



TF Taglio di Fase - Phase-Cut Dimmer - Phasenabschrittdimmer

A Alimentatore nel rosone - Power Supply inside the ceiling rose - Netzteil in der Deckendose

Esempio - Example - Beispiel *
 3570lm con - with - mit **E2**







5022MDM

DIM (Push) - 62W 5100lm* - 220V

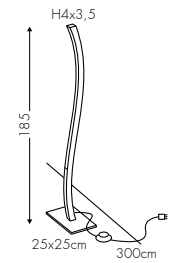

CUSTOM RV OV BR



A E2 Opale - Opal



A 2700K



B 3000K



BV



NE



RU



SO



Alimentatore Incorporato - Incorporated Power Supply - Eingebautes Netzteil







 
MADE in ITALY

Oki è un elemento a parete o a soffitto in grado di integrarsi tanto in contesti domestici quanto in ambienti tecnici. La superficie luminosa leggermente rientrante rispetto al bordo costituisce un elemento di raffinatezza che contribuisce a diminuire la luminanza, migliorando il comfort visivo.

Oki is a wall or ceiling lamp that can be placed both in a domestic context as well as in technical environments. The luminous surface slightly lowered with respect to the edge is an element of refinement that contributes to lower luminance, improving visual comfort.

Oki ist eine Decken- oder Wandleuchte, die sowohl in häuslichen als auch in technischen Kontexten integriert werden kann. Die Lichtfläche, die etwas tiefer als der Rand liegt, ist ein Element, das zu einer geringeren Leuchtdichte und einem verbesserten Sehkomfort beiträgt.



OKI

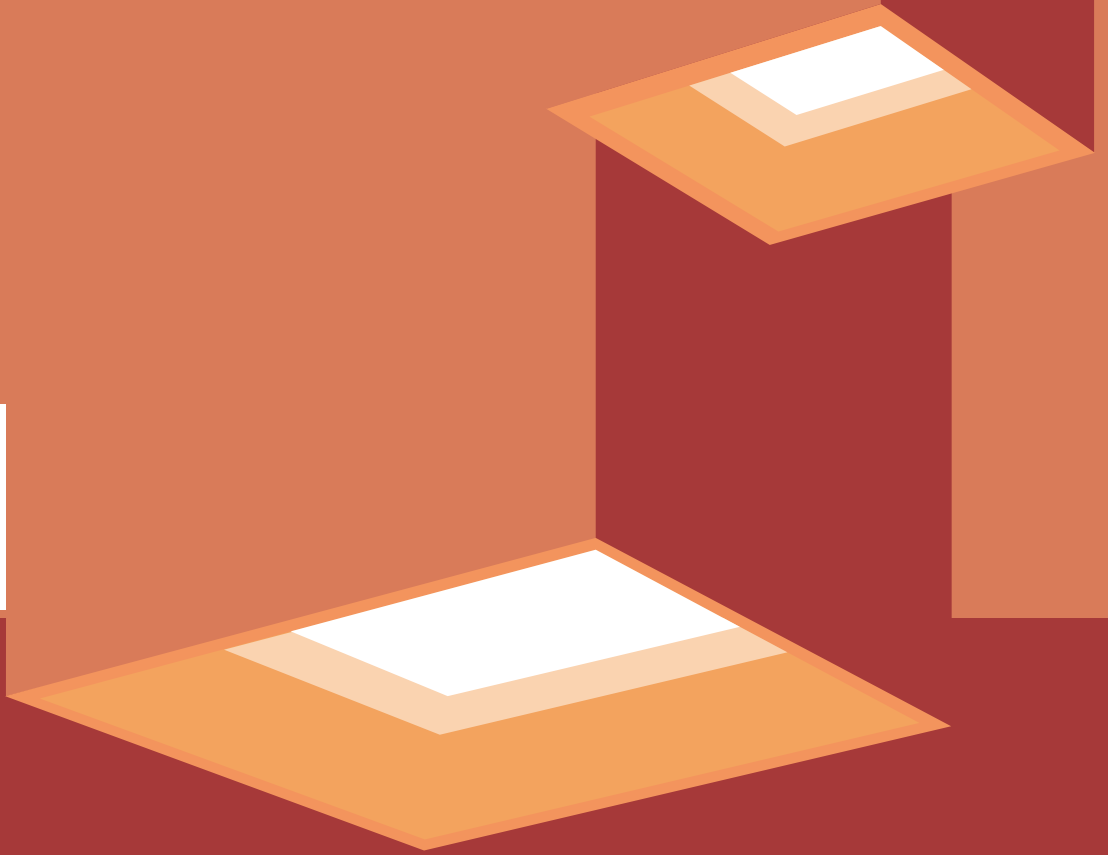



OKI

Linee minimali e corpo in alluminio, la gamma Oki led a sospensione offre un'illuminazione diffusa mantenendo le caratteristiche del perfetto complemento d'arredo per ogni ambiente.

Minimal lines and aluminum body, suspension led lamp Oki provides diffuse lighting and the features of a perfect piece of furniture for all the environments.

Mit ihren minimalen Linien und einem Aluminium Lampenkörper aus ergeben die Oki Led Decken- und Wandleuchten eine diffuse Beleuchtung, die sich jeder Umgebung anpassen.



1009ATF

13W 1000lm* - 220V

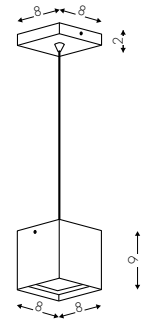

1009BTF

26W 2000lm - 220V

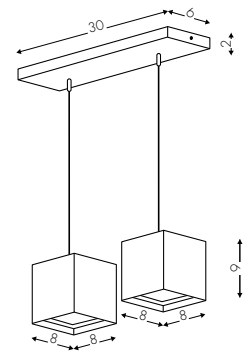

CUSTOM



E28 Satinato - Frosted - Satiniert

B 3000K

BV **NE** **RU**

TF Taglio di Fase - Phase-Cut Dimmer - Phasenabschrittdimmer

A Alimentatore Incorporato - Incorporated Power Supply - Eingebautes Netzteil

Esempio - Example - Beispiel *

1000lm con - with - mit **E28**







OKI

Linee minimali e corpo in alluminio, la gamma Oki led soffitto e parete offre un'illuminazione diffusa adatta a tutti gli ambienti.

Minimal lines and aluminum body, Oki, available in ceiling or wall version, provides a diffused lighting suitable for all the environments.

Mit ihren minimalen Linien und einem Lampenkörper aus Aluminium, ergeben die Oki LED Decken- und Wandleuchten eine diffuse Beleuchtung, die sich jeder Umgebung anpassen.

**3009BTF**

4.3W 420lm* - 220V

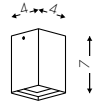
**3009ATF**

13W 1000lm - 220V

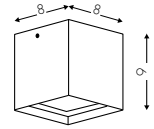
**3009DTF**

20W 1700lm - 220V

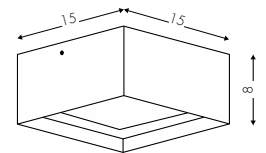

TO
CUSTOM 

**A** E28 Satinato - Frosted - Satiniert B 3000K

BV  NE  RU 

TF Taglio di Fase - Phase-Cut Dimmer - Phasenabschrittdimmer**A** Alimentatore Incorporato - Incorporated Power Supply - Eingebautes Netzteil

Esempio - Example - Beispiel *
420lm con - with - mit **E28**







3009M TF

26W 2000lm* - 220V

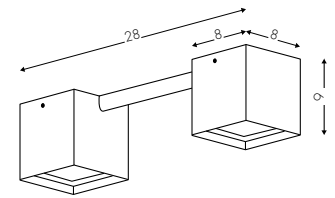

3009N TF

43W 3500lm - 220V

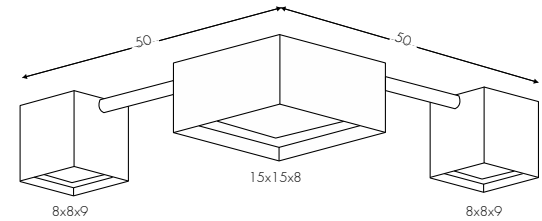

CUSTOM



A E28 Satinato - Frosted - Satiniert

B 3000K

BV NE RU

TF Taglio di Fase - Phase-Cut Dimmer - Phasenabschnittdimmer

A Alimentatore Incorporato - Incorporated Power Supply - Eingebautes Netzteil

Esempio - Example - Beispiel *
2000lm con - with - mit **E28**







2009AOF

1x GU10 max 7W - 220V

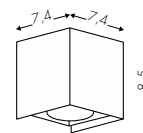

2009BOF

2x GU10 max 7W - 220V

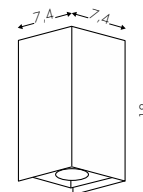

   **GU10**

BV **NE** **RU**
  

GU10 Sorgente GU10 non inclusa - GU10 light source not included - GU10 Lichtquelle nicht enthalten







MADE in ITALY

Linearità della forma e ricercatezza delle finiture rendono "S-pot Home" una soluzione semplice ed efficace per l'illuminazione d'accento in ambito residenziale; disponibile nelle versioni Sospensione e Plafone.

The linearity of the form and its finishes refinement make "S-Pot Home" a simple and effective solution for accent lighting in residential environments; available in suspension and ceiling light versions.

Die Linearität der Form und die anspruchvolle Feinarbeiten machen "S-pot Home" zu einer einfachen und effektiven Lösung für die Akzentbeleuchtung in Wohngebieten; Pendel- und Wandleuchten Ausführungen sind erhältlich.



The image features a vertical gradient background transitioning from a dark reddish-brown on the left to a lighter, warm orange on the right. Two cylindrical pendant lights hang from the top. The light on the left is a bright orange and is positioned higher. The light on the right is a dark red and is positioned lower. Both lights have a white circular glow at their base, suggesting they are illuminated. The text 'S-POT' is centered in the lower half of the image, overlapping the bottom of the orange light and the top of the dark red light.

S-POT



S-POT HOME

Corpo in alluminio verniciato a polveri nelle principali finiture Team Italia.
Disponibile nelle lunghezze 15, 30, 60 e 90 cm; predisposto per sorgenti luminose GU10.

Powder-coated aluminum body painted with the main TeamItalia finishes.
Available in 15 cm, 30 cm, 60 cm and 90 cm lengths; designed for GU10 light source.

Pulver lackierter Aluminiumkörper in den Team Italia Hauptfeinarbeiten erhältlich. Erhältlich in Längen von 15, 30, 60 und 90 cm; gestaltet für GU10 Lichtquellen.

3018C

1x GU10 max 7W LED - 220V

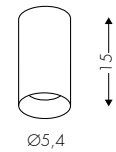

3018D

1x GU10 max 7W LED - 220V

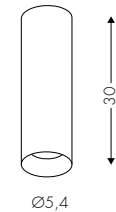

GU10

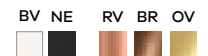

GU10 Sorgente GU10 non inclusa - GU10 light source not included - GU10 Lichtquelle nicht enthalten







3018E

1x GU10 max 7W LED - 220V



3018F

1x GU10 max 7W LED - 220V

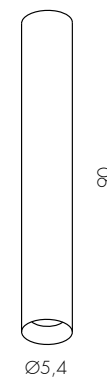

GU10



GU10 Sorgente GU10 non inclusa - GU10 light source not included - GU10 Lichtquelle nicht enthalten







1018C

1x GU10 max 7W LED - 220V

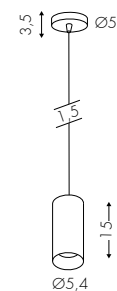

1018D

1x GU10 max 7W LED - 220V

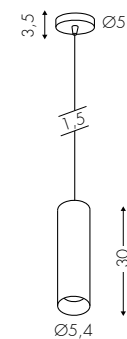

1018E

1x GU10 max 7W LED - 220V

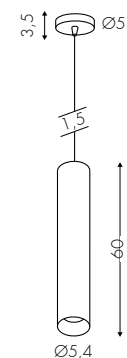

CUSTOM BLACK CABLE 



GU10



GU10 Sorgente GU10 non inclusa - GU10 light source not included - GU10 Lichtquelle nicht enthalten







 
MADE in ITALY

Eccezionalmente versatile, questo apparecchio si presta per l'illuminazione diretta o indiretta a soffitto o a parete. Il flusso luminoso di Overlap può essere orientato, rendendone l'utilizzo estremamente flessibile. L'operazione di orientamento risulta semplice e precisa.

Flexible use for this lamp, Overlap is suitable for direct or indirect lighting on the ceiling or wall-mounted. The lamp can be oriented to control the light flux, this operation is simple and precise.

Diese Lampe ist besonders vielseitig: sie eignet sich für die direkte oder indirekte Lichtemission von der Decke oder von der Wand aus. Man kann den Lichtstrom von Overlap verstellen und das ermöglicht eine extrem flexible Verwendung. Das Orientieren des Lichtstroms ist einfach und präzise.



An abstract graphic on a solid orange background. It features several overlapping lines: a thick white line, a thick orange line, and a thin white line. The white line starts from the top left, goes down and right, then curves down and left, ending at the bottom left. The orange line starts from the top left, goes down and right, then curves down and left, ending at the bottom left. The thin white line starts from the top left, goes down and right, then curves down and left, ending at the bottom left. The word "OVERLAP" is written in a bold, white, sans-serif font at the bottom center of the image.

OVERLAP



OVERLAP

Overlap significa sovrapporre. lampada a plafone o parete che può essere orientata per ottenere un'emissione diretta o indiretta. I moduli possono essere composti per illuminare anche lontano dal punto luce.

Ceiling or wall lamp that can be oriented to obtain direct or indirect emission. The modules can be composed to illuminate all the space, even far from the light point.

Overlap heißt überlappen. Verstellbare Decken- oder Wandleuchte für eine direkte oder indirekte Lichtemission. Die Zusammensetzung der verschiedenen Module ermöglicht eine Beleuchtung weit von der Lichtquelle entfernt.



3015IOF
3015IDM

26W 2295lm* + 38W 2730lm - 220V
DALI (Push) - 26W 2295lm + 38W 2730lm - 220V

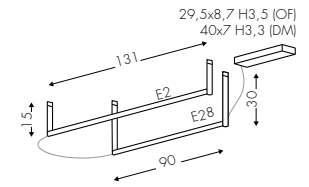

3015LOF
3015LDM

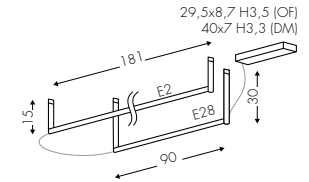

26W 2295lm + 52W 3780lm - 220V
DALI (Push) - 26W 2295lm + 52W 3780lm - 220V

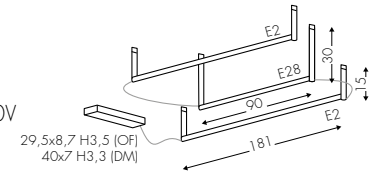

3015MOF
3015MDM

2x52W 7560lm + 26W 2295lm - 220V
DALI (Push) - 2x52W 7560lm + 26W 2295lm - 220V



CUSTOM WHITE CABLE 
CUSTOM RED CABLE 



A

E2 Opale - Opal
E28 Satinato - Frosted - Satiniert

A 2700K

B 3000K

BV

A Alimentatore nel rosone - Power Supply inside the ceiling rose - Netzteil in der Deckendose







OVERLAP

Lampada a parete che può essere orientata per ottenere un'emissione frontale o riflessa.

Wall lamp that can be oriented to obtain front or reflected emission.

Wandleuchte für eine frontale oder reflektierte Lichtemission.

**5015AOF**

52W 3645lm* - 220V

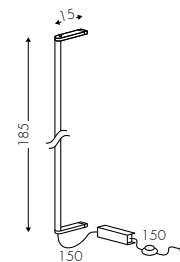
**5015ADM**

DIM (RF) - 52W 3645lm - 220V

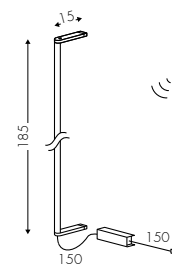

CUSTOM RED CABLE

**A**

E2 Opale - Opal

A 2700K **B** 3000K**BV****A** Alimentatore nel rosone - Power Supply inside the ceiling rose - Netzteil in der Deckendose

Esempio - Example - Beispiel *
3645lm con - with - mit **E2**







 
MADE in ITALY

Eccezionalmente versatile e con particolari finiture, questo apparecchio si presta per l'illuminazione diretta o indiretta a sospensione. Overlap può essere orientato nel flusso luminoso, rendendone l'utilizzo estremamente flessibile. L'operazione di orientamento risulta semplice e precisa.

Flexible use and special finishes for this lamp, Overlap is suitable for direct or indirect lighting on the ceiling or wall-mounted. The lamp can be oriented to control the light flux, this operation is simple and precise.

Diese Lampe mit speziellen Oberflächen ist besonders vielseitig: sie eignet sich für die direkte oder indirekte Lichtemission von der Decke oder von der Wand aus. Man kann den Lichtstrom von Overlap verstellen und das ermöglicht eine extrem flexible Verwendung. Das Orientieren des Lichtstroms ist einfach und präzise.





OVERLAP 2.0



OVERLAP 2.0

Versione singola di Overlap a sospensione per l'illuminazione morbida e diffusa degli ambienti, disponibile nelle finiture standard o in nuove brillanti finiture metallizzate oro, rame, bronzo. Alimentatore incluso nel rosone.

Stand alone version of Overlap suspension lamp for a soft and diffused lighting of the environments, available in standard finishes or in the new bright gold, copper, bronze metallic finishes.

The power supply is included in the ceiling rose.

Einzel Ausführung von Overlap Pendelleuchte für eine leichte und diffuse Beleuchtung der Räume. In Standardausführung erhältlich oder mit neuem Gold, Kupfer, Bronze metallisiertem Glanzlack. Das Netzteil ist in der Rosette enthalten.



1015COF
1015CDM

28W 1890lm* - 220V
DALI (Push) - 28W 1890lm - 220V

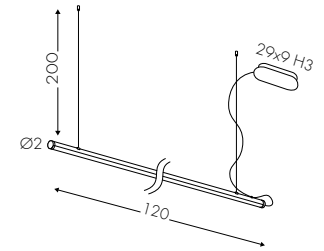

1015DOF
1015DDM

35W 2350lm - 220V
DALI (Push) - 35W 2350lm - 220V

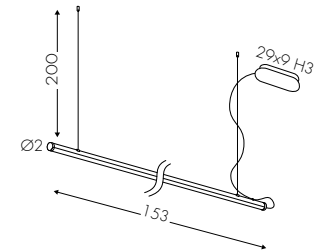

1015EOF
1015EDM

55W 3800lm - 220V
DALI (Push) - 55W 3800lm - 220V

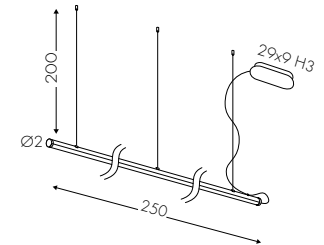

CUSTOM BLACK CABLE ●



A E2 Opale - Opal

● A 2700K

● B 3000K

BV NE RU OV BR RV



A Alimentatore nel rosone - Power Supply inside the ceiling rose - Netzteil in der Deckendose

Esempio - Example - Beispiel *
1890lm con - with - mit E2







OVERLAP COMPOSITION

Composizioni di Overlap a sospensione a due elementi downlight o tre elementi orientabili Up+Downlight. Disponibile nelle finiture standard o in nuove brillanti finiture metallizzate oro, rame e bronzo.
Alimentatore incluso nel rosone.

Compositions of Overlap suspension lamp with two downlight elements or three adjustable Up + Downlight elements. Available in standard finishes or in the new bright gold, copper, and bronze metallic finishes.
The power supply is included in the ceiling rose.

Zusammensetzung von Overlap Pendelleuchte durch zwei downlight oder drei erstellbare Up+Downlight Elemente. In Standardausführung erhältlich oder mit neuem Gold, Kupfer und Bronze metallisiertem Glanzlack.
Das Netzteil ist in der Rosette erhalten.

1015FOF

1015FDM

70W 4700lm* - 220V

DALI (Push) - 70W 4700lm - 220V

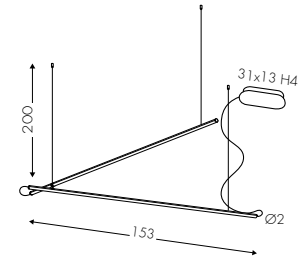

1015GOF

1015GDM

84W 5660lm - 220V

DALI (Push) - 84W 5660lm - 220V

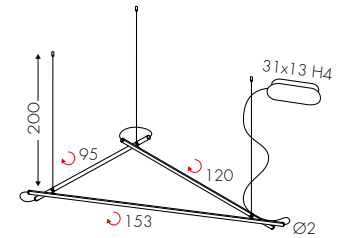

A E2 Opale - Opal

● A 2700K

● B 3000K



A Alimentatore nel rosone - Power Supply inside the ceiling rose - Netzteil in der Deckendose

Esempio - Example - Beispiel *
4700lm con - with - mit E2







Lieve, design minimale per questa lampada che si pone con discrezione nel progetto d'interni. Nonostante le dimensioni ridotte garantisce un rapporto ottimale tra potenza d'emissione e controllo della luminanza.

Lieve, minimal design for this lamp created to light up with refinement. Despite of the slim size, Lieve ensures an optimal balance between the emission power and the control of the luminance.

Feines, minimales Design für diese Lampe, die in einer Innenraumplanung diskret ihr Platz findet. Trotz der verringerten Ausmaßen versichert sie ein optimales Verhältnis zwischen Lichtemissionsvermögen und Helligkeitssteuerung.



BELIEVE

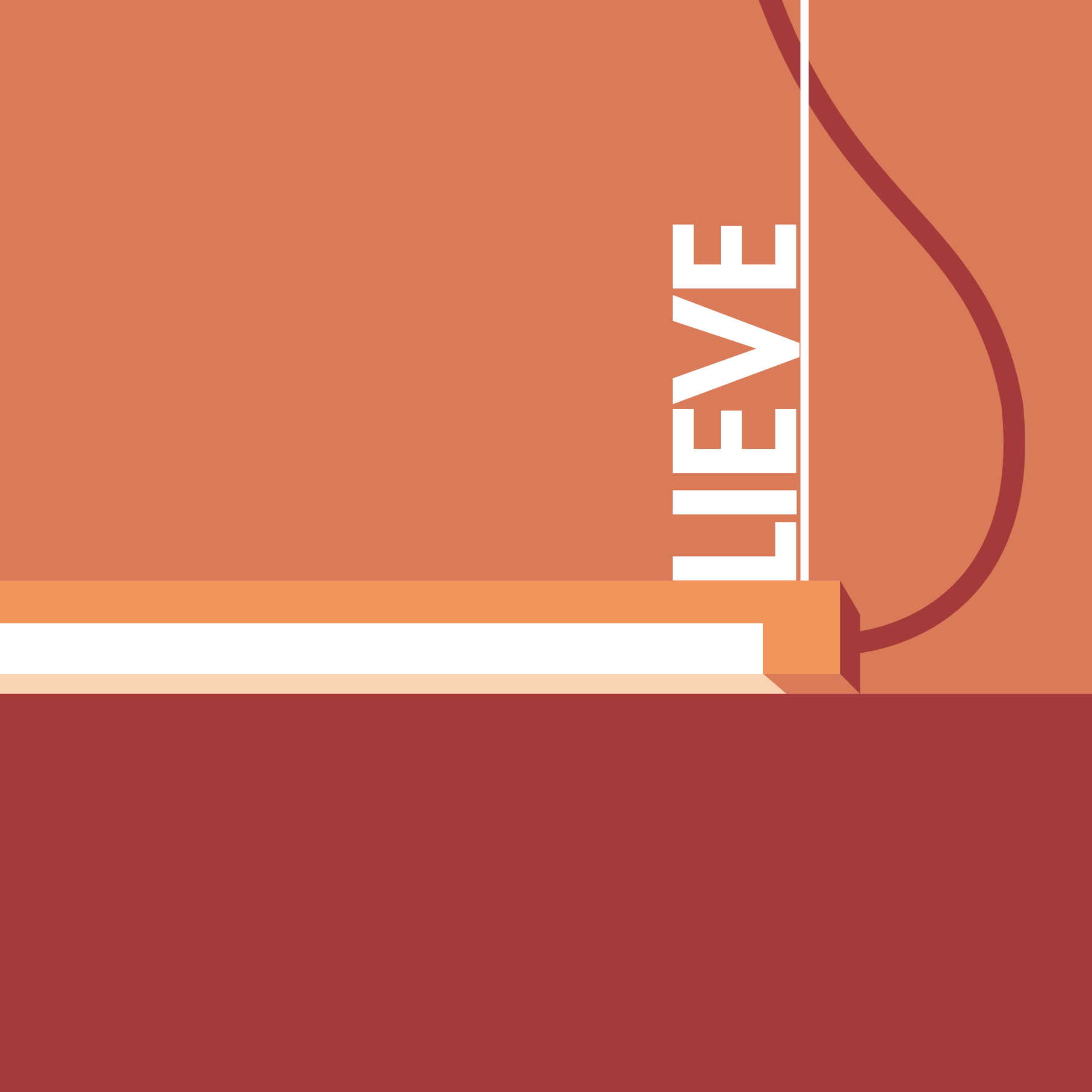



LIEVE

Lampada a sospensione con sorgente luminosa a led. Alimentatore incluso nel rosone a soffitto.

Pendant lamp with led light source. Remote power supply included in the ceiling rose.

Pendelleuchte mit Led-Lichtquelle. Das Netzteil ist in der Rosette enthalten.



1016AOF
1016ADM

21W 1420lm* - 220V
DALI (Push) - 21W 1420lm - 220V

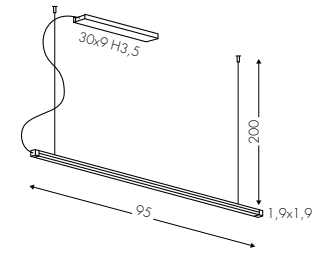

1016BOF
1016BDM

28W 1890lm - 220V
DALI (Push) - 28W 1890lm - 220V

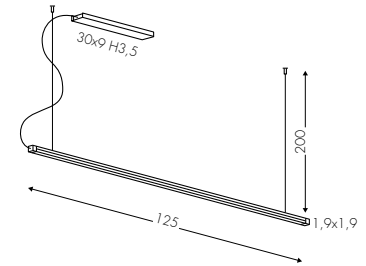

1016COF
1016CDM

35W 2350lm - 220V
DALI (Push) - 35W 2350lm - 220V

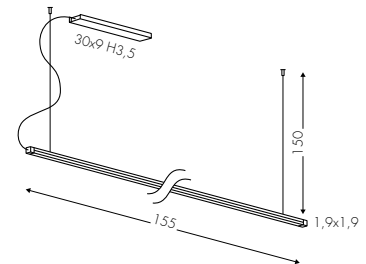

CUSTOM RED CABLE 



A E2 Opale - Opal

 A 2700K

 B 3000K

BV



A Alimentatore nel rosone - Power Supply inside the ceiling rose - Netzteil in der Deckendose

Esempio - Example - Beispiel *
1420lm con - with - mit E2







 
MADE in ITALY

120

Linea dark è la soluzione ideale per i progetti che richiedono livelli di luminanza controllata. Con stile minimale, questa famiglia si integra nell'illuminazione della postazione lavorativa così come nello shop lighting.

Linea Dark is the perfect solution for interior projects that require controlled luminance levels. With a minimal design, this lamp can be integrated in residential, working and shopping locations.

Linea Dark ist die ideale Lösung für Projekte die verschiedene Stufen an Helligkeitssteuerung benötigen. Mit minimalem Stil, integriert sich diese Lampenpalette sowohl in der Arbeitsplatzbeleuchtung, als auch im Shop-Lighting.



LINEA DARK





LINEA DARK

Lampada a sospensione e a parete con sorgente arretrata a led per il controllo dell'abbagliamento luminoso. Emissione up-down. Alimentatore remoto incluso.

Pendant and wall lamp with led light source to control the bright glare. Up-down emission. The power supply is remotely included.

Pendelleuchte und Wandleuchte mit rückwärtiger Led-Lichtquelle für die Blendenschutz Kontrolle. Up-down Lichtemission. Das Fern-Netzteil ist mit inbegriffen.



1021AOF

21W 2200lm* + 5W 425lm - 220V

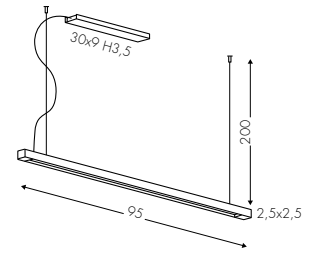

1021BOF

27W 2320lm + 5W 425lm - 220V

1021BDM

DALI (Push) - 27W 2320lm + 5W 425lm - 220V

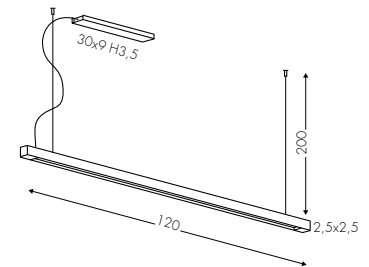

1021COF

35W 2975lm + 5W 425lm - 220V

1021CDM

DALI (Push) - 35W 2975lm + 5W 425lm - 220V

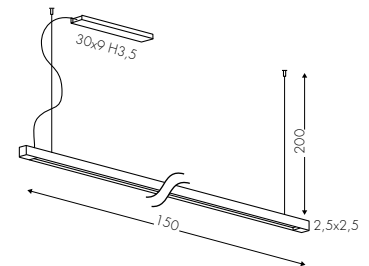

A E19 UGR<19 Prism

● A 2700K

● B 3000K



A Alimentatore nel rosone - Power Supply inside the ceiling rose - Netzteil in der Deckendose

Esempio - Example - Beispiel *
2200lm con - with - mit E19







LINEA DARK PARETE

Lampada a parete monoemissione diretta verso il basso dalle dimensioni contenute e lineari. Ideale come sopra specchio e per l'illuminazione dei quadri.

Wall lamp with single down emission and slim size. Perfect to light up mirrors and paintings.

Wandleuchte aus beschränkten und linearen Ausmaßen mit Einzel-Lichtemission nach unten gerichtet. Ideal über einen Spiegel oder für die Beleuchtung eines Bildes.



2021AOF 10W 1250lm* - 220V

2021ATF 10W 1250lm - 220V

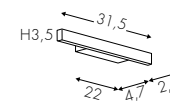

2021BOF 20W 2200lm - 220V

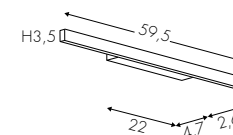

2021COF 30W 3400lm - 220V

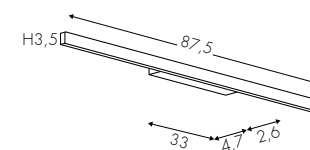

2021DOF 38W 4400lm - 220V

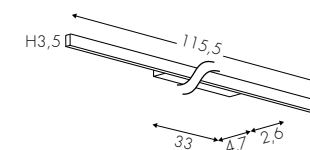

A E2 Opale - Opal



A 2700K



B 3000K



TF Taglio di Fase - Phase-Cut Dimmer - Phasenabschrittdimmer

A Alimentatore Incorporato - Incorporated Power Supply - Eingebautes Netzteil

Esempio - Example - Beispiel *

1250lm con - with - mit **E2**







 
MADE in ITALY

Linee essenziali ed alto flusso luminoso controllato sono le caratteristiche che distinguono questa famiglia di prodotto. I componenti di qualità attentamente selezionati sono racchiusi in un corpo dalla dimensione contenuta e forma minimale.

Essential lines and high controlled luminous flux are the features that define this product family. The carefully selected quality components are enclosed in a small size lamp body and a minimal shape.

Essentielle Linien und ein hoher kontrollierter Lichtstrom sind die Merkmale, die diese Produktfamilie auszeichnen. Die sorgfältig ausgewählten Qualitätskomponenten sind in einem Gehäuse mit geringer Größe und minimaler Form eingeschlossen.



ARIELL





ARIELL

Lampada a parete lineare con emissione diretta o indiretta in funzione dell'installazione. Alimentatore incorporato.

Linear wall lamp with single direct or indirect light emission depending on the installation. Integrated power supply.

Lineare Wandleuchte mit direkter oder indirekter Lichtemission je nach Montage. Mit integriertem Netzteil.



2026BOF
2026BTF

9W 1350lm* - 220V
9W 1350lm - 220V

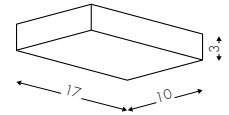

2026DOF
2026DDM
2026DTF

21W 3000lm - 220V
DALI (Push) - 21W 3000lm - 220V
21W 3000lm - 220V

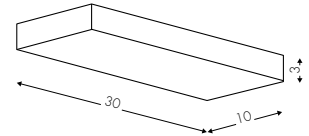

2026FOF
2026FDM

35W 5000lm - 220V
DALI (Push) - 35W 5000lm - 220V

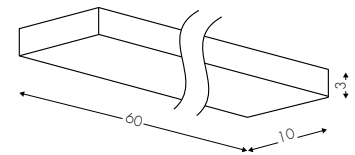

E28 Satinato - Frosted
Satinert



A 2700K

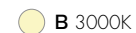

B 3000K

BV **NE** **RU**



TF Taglio di Fase - Phase-Cut Dimmer - Phasenabschrittdimmer

A Alimentatore Incorporato - Incorporated Power Supply - Eingebautes Netzteil

Esempio - Example - Beispiel *
1350lm con - with - mit **E28**







2026MOF 60W 8200lm* - 220V
2026MDM DALI (Push) - 60W 8200lm - 220V

 **E28** Satinato - Frosted - Satiniert

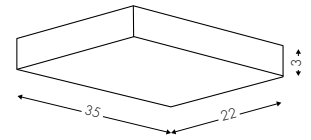

2026NOF 70W 9200lm - 220V
2026NDM DALI (Push) - 70W 9200lm - 220V

 **E28** Satinato - Frosted - Satiniert

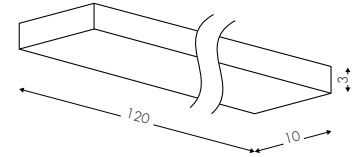

2026OOF 50W 6500lm + 10W 1500lm - 220V
2026ODM DALI (Push) - 50W 6500lm + 10W 1500lm - 220V

 **E28** Satinato - Frosted - Satiniert
E19 UGR<19 Prism

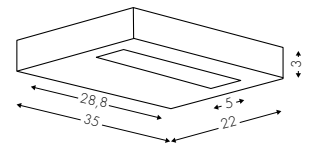

SUPERFLUX



 **A** 2700K  **B** 3000K

BV **NE** **RU**
  

 Alimentatore Incorporato - Incorporated Power Supply - Eingebautes Netzteil

Esempio - Example - Beispiel *
 8200lm con - with - mit **E28**







 
MADE in ITALY

132

Orizzonte si caratterizza per un design morbido e pulito, in grado di creare la giusta atmosfera nel progetto d'interni grazie alle misure e ai diversi flussi luminosi disponibili.

Orizzonte is a wall lamp characterized by a soft and clean design, able to create the right atmosphere in the interior thanks to the different measures available and to the different luminous fluxes.

Orizzonte Wandleuchte ist eine schlichte und weiche Design-Lampe. Dank der Verfügbarkeit an verschiedener Lichtquellen ist sie imstande die richtige Atmosphäre in einer Innenraumplanung zu erschaffen.



The image features a solid orange background. In the upper left, a white horizontal line is partially visible. Below it, a dark red shape curves downwards and to the right. A light orange shape, resembling a stylized arrow or a curved line, points from the dark red area towards the right. The word "ORIZZONTE" is written in a bold, white, sans-serif font across the upper middle section of the image.

ORIZZONTE



ORIZZONTE

Lampada a parete biemissione con sorgente luminosa a led disponibile in versione up/down. Alimentatore incluso.

Double light emission wall lamp with led light source Power supply included.

Dopple Licht Emission Wandleuchte mit Led-Lichtquelle. Das Netzteil ist mit inbegriffen.



2004EOF
2004ETF

4,5W 450lm* + 4,5W 450lm - 220V
4,5W 450lm + 4,5W 450lm - 220V

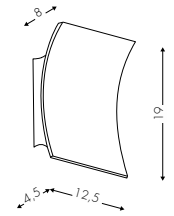

2004DOF
2004DDM
2004DTF

10W 1300lm + 10W 1300lm - 220V
DALI (Push) - 10W 1300lm + 10W 1300lm - 220V
10W 1300lm + 10W 1300lm - 220V

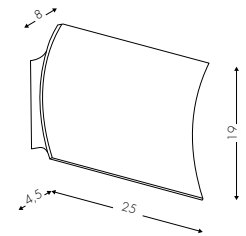

2004COF
2004CDM
2004CTF

18W 1800lm + 18W 1800lm - 220V
DALI (Push) - 18W 1800lm + 18W 1800lm - 220V
18W 1800lm + 18W 1800lm - 220V

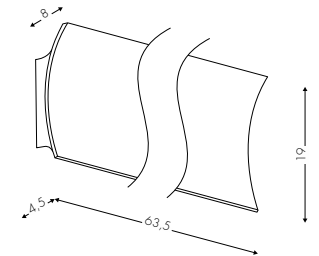

2004AOF
2004ADM
2004AOFEM

26W 2700lm + 26W 2700lm - 220V
DALI (Push) - 26W 2700lm + 26W 2700lm - 220V
26W 2700lm + 26W 2700lm - 220V

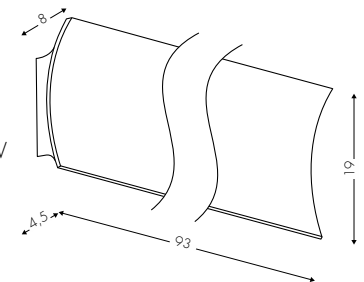

A E28 Satinato - Frosted - Satiniert

A 2700K

B 3000K



EM Emergenza - Emergency - Notbeleuchtung

TF Taglio di Fase - Phase-Cut Dimmer - Phasenabschrittdimmer

A Alimentatore Incorporato - Incorporated Power Supply - Eingebautes Netzteil

Esempio - Example - Beispiel *
450lm con - with - mit **E28**







MADE in ITALY

136

Un intreccio di linee che non perdono mai la semplicità e il minimalismo che caratterizza Tao. L'ampia disponibilità di finiture lo rende un vero e proprio complemento d'arredo.

Tao is characterized by a twist of lines that never lose simplicity and minimalism. The wide range of finishes makes Tao an unique piece of furniture.

Linien Geflecht das niemals die einfache und schlichte Eigenschaft von Tao verliert. Die vielfältige Verfügbarkeit an Feinbearbeitungen macht aus Tao ein wahres Einrichtungszubehör.





TAO



TAO

Lampada a parete con sorgente luminosa a led disponibile in versione up/down e in un'ampia combinazione di colori. Alimentatore incluso integrato.

Wall lamp with led light source available with up/down emission and with a wide range of colors combinations. Integrated power supply.

Wandleuchte mit Led-Lichtquelle, in Up-Down Ausführung und eine breite Farbkombination Verfügbar. Ein integriertes Netzteil ist mit inbegriffen.



D700OF

13W 1800lm* - 220V

D700TF

13W 1800lm - 220V

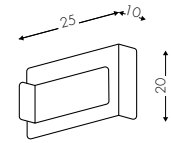

D702OF

21W 2800lm - 220V

D702DM

DALI (Push) - 21W 2800lm - 220V

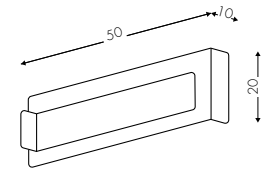

D703OF

29W 4000lm - 220V

D703DM

DALI (Push) - 29W 4000lm - 220V

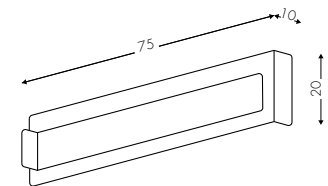

A E2 Opale - Opal

A 2700K

B 3000K

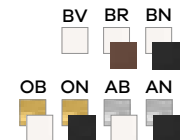

TF Taglio di Fase - Phase-Cut Dimmer - Phasenabschrittdimmer

A Alimentatore Incorporato - Incorporated Power Supply - Eingebautes Netzteil

Esempio - Example - Beispiel *

1800lm con - with - mit **E2**







 
MADE in ITALY

Un design minimalista combinato con un uso innovativo ed elegante del vetro, sono gli elementi distintivi di questa famiglia di prodotti. Compact si adatta con la massima flessibilità alle diverse esigenze di installazione grazie alle numerose forme e dimensioni disponibili. Linee semplici, mai anonime, che si integrano con numerosi stili di progettazione d'interni.

A minimal design combined with an innovative and stylish use of the glass are the distinctive elements of this family of products. Compact fits with the maximum flexibility to the different needs of installation thanks to the numerous shapes and sizes available. Simple, never anonymous lines, easy to be integrated with many interior design styles.

Ein minimales Design kombiniert mit einer innovativen und eleganten Glas-Anwendung sind die Unterscheidungsmerkmale dieser Produkt-Familie. Compact passt sich mit maximaler Flexibilität an verschiedene Installationsbedürfnisse an, dank der zahlreichen Formen und Ausmaßen die zu Verfügung stehen. Einfache, niemals anonyme Linien, die sich gut mit verschiedenen Innendesign Stile integrieren.



COMPACT





COMPACT

Vetro diffusore, con angoli 45° incollati per ottenere un effetto luminoso diffuso
Alimentatore integrato.

White glass with glued 45° corners to obtain a diffused and uniform luminous effect. Integrated power supply.

Weißes Glas Diffusor mit angeklebten 45° Grad Winkeln, um ein diffuses und homogenes Lichteffect zu erwirken.



D320 4W 350lm* - 220V

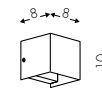

D321 7W 1100lm - 220V

D321TF 7W 1100lm - 220V

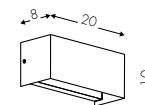

D326 21W 2420lm - 220V

D326DM DALI (Push) - 21W 2420lm - 220V

D326TF 21W 2420lm - 220V

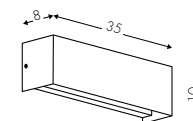

D325 29W 3400lm - 220V

D325DM DALI (Push) - 29W 3400lm - 220V

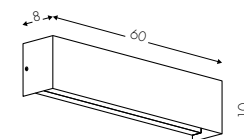

A E2 Opale - Opal

A 2700K **B** 3000K



TF Taglio di Fase - Phase-Cut Dimmer - Phasenabschnittdimmer

A Alimentatore Incorporato - Incorporated Power Supply - Eingebautes Netzteil

Esempio - Example - Beispiel *
350lm con - with - mit **E2**







E321

1x E27 max 70W ES / 10W LED - 220V

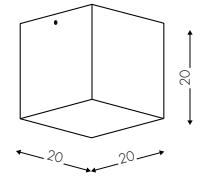

E322

2x E27 max 42W ES / 10W LED - 220V

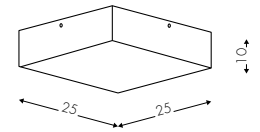

E323

3x E27 max 42W ES / 10W LED - 220V

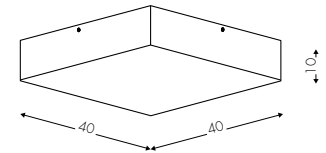

    **E27** E2 Opale - Opal

BV

E27 Sorgente E27 non inclusa - E27 light source not included - E27 Lichtquelle nicht enthalten



E320

4W 350lm* - 220V

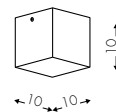

D322

21W 2420lm - 220V

D322DM

DALI (Push) - 21W 2420lm - 220V

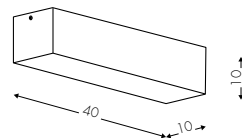

D323

29W 3400lm - 220V

D323DM

DALI (Push) - 29W 3400lm - 220V

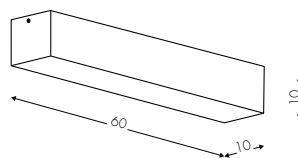

A

E2 Opale - Opal

A 2700K

B 3000K

BV



A Alimentatore Incorporato - Incorporated Power Supply - Eingebautes Netzteil

Esempio - Example - Beispiel *

350lm con - with - mit **E2**



 
MADE in ITALY

Modello depositato

Riflessa interpreta ed esprime le potenzialità delle innovative e più efficienti sorgenti luminose led restituendo nell'ambiente luce indiretta potente ma delicatamente distribuita e priva di ombre. Nei modelli biemissione una seconda sorgente concentrata affianca la principale illuminando con precisione e comfort il task visivo.

Riflessa expresses the potential of the innovative and most efficient LED light sources, which provide powerful but delicately distributed indirect light, creating no shadows. In the double emission models a second concentrated source, together with the main one, lights up the object with precision and comfort.

Riflessa bringt das Potenzial der innovativen und effizienteren LED-Lichtquellen zum Ausdruck, indem es indirektes und starkes Licht aber fein verteilt in die Umgebung anbietet, ohne Schatten zu bilden. Bei der doppelten Lichtemission Variante leuchtet eine zweite konzentrierte Lichtquelle, zusammen mit der Hauptquelle, die Objekte mit Präzision und Komfort.



RIFLESSA





RIFLESSA UP

Lampada a sospensione lineare con alimentatore incorporato ad emissione luminosa diffusa totalmente indiretta; struttura in alluminio verniciato e diffusore in pmma satinato.

Linear suspension lamp with integrated power supply unit and indirect diffuse light source. Aluminum finishing and frosted pmma diffusor.

Lineare Pendelleuchte mit eingebautem Netzgerät und indirektem diffusem Lichtemission. Aluminium Lackierung und satiniertes pmma Diffusor.



1052BOF

36W 4050lm* - 220V

1052BDM

DALI (Push) - 36W 4050lm - 220V

1052BBT

36W 4050lm - 220V

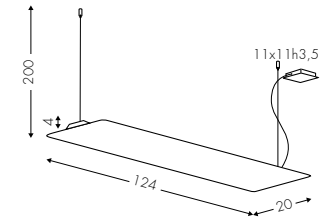

1052EOF

63W 7050lm - 220V

1052EDM

DALI (Push) - 63W 7050lm - 220V

1052EBT

63W 7050lm - 220V

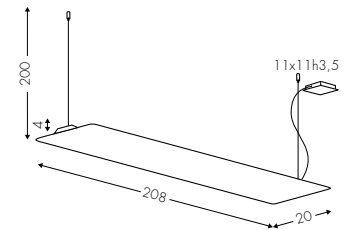

1052HOF

90W 10100lm - 220V

1052HDM

DALI (Push) - 90W 10100lm - 220V

1052HBT

90W 10100lm - 220V

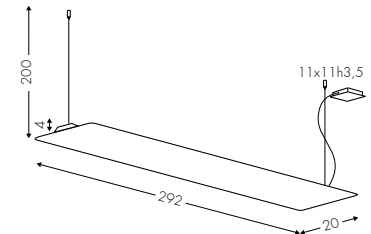

E28 Satinato
Frosted - Satinert

● **A** 2700K ● **B** 3000K

BV NE RU RV BR OV SO



BT Bluetooth - Bluetooth - Bluetooth

A Alimentatore Incorporato - Incorporated Power Supply - Eingebautes Netzteil

Esempio - Example - Beispiel *
4050lm con - with - mit **E28**







RIFLESSA DARK

Lampada a sospensione lineare biemissione, luce principale indiretta diffusa, sorgente secondaria diretta darklight con limitazione dell'abbagliamento. Alimentatore incorporato; struttura in alluminio verniciato e diffusore in pmma satinato.

Double-light source suspension lamp, the main light source is indirect and diffused. The secondary darklight-source is direct with glare reduction. The power supply is included. Aluminum finishing and frosted pmma diffusor.

Doppelte Licht-Emission Pendelleuchte. Die Haupte-Lichtquelle ist indirekt und diffuses, die sekundäre Lichtquellen mit direktem darklight bieten reduzierte Blendung. Das Netzteil ist enthalten. Aluminium Lackierung und satiniertes pmma Diffusor.



1053BOF
1053BDM
1053BBT

36W 4050lm* + 7,5W 1000lm - 220V
DALI (Push) - 36W 4050lm + 7,5W 1000lm - 220V
36W 4050lm + 7,5W 1000lm - 220V

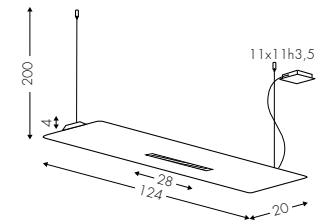

1053EOF
1053EDM
1053EBT

63W 7050lm + 15W 2000lm - 220V
DALI (Push) - 63W 7050lm + 15W 2000lm - 220V
63W 7050lm + 15W 2000lm - 220V

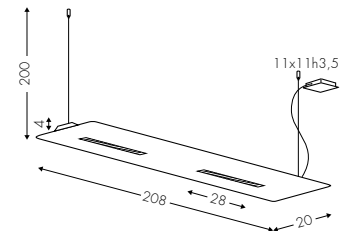

1053HOF
1053HDM
1053HBT

90W 10100lm + 21W 3000lm - 220V
DALI (Push) - 90W 10100lm + 21W 3000lm - 220V
90W 10100lm + 21W 3000lm - 220V

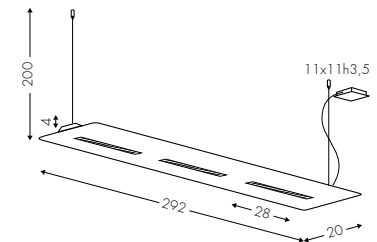

A E28 Satinato - Frosted - Satinert
55° Ottica - Optic - Optik



BV NE RU RV BR OV SO



BT Bluetooth - Bluetooth - Bluetooth

A Alimentatore Incorporato - Incorporated Power Supply - Eingebautes Netzteil

Esempio - Example - Beispiel *
4050lm con - with - mit **E28**







RIFLESSA S-POT

Lampada a sospensione lineare biemissione, luce principale indiretta diffusa, sorgenti luminose secondarie orientabili ad emissione focalizzata. Alimentatore incorporato; struttura in alluminio verniciato e diffusore in pmma satinato.

Double-light source suspension lamp, the main light source is indirect and diffused. Secondary concentrated light-sources are also adjustable. The power supply is included. Aluminum finishing and frosted pmma diffusor.

Doppelte Licht-Emission Pendelleuchte. Die Haupte-Lichtquelle ist indirekt und diffuses, die sekundäre Lichtquellen sind adjustable und bieten eine Akzentbeleuchtung. Das Netzteil ist enthalten. Aluminium Lackierung und satiniertes pmma Diffusor.



1054BOF

1054BDM

1054BBT

36W 4050lm* + 1x7W 1x680lm - 220V

DAI (Push) - 36W 4050lm + 1x7W 1x680lm - 220V

36W 4050lm + 1x7W 1x680lm - 220V

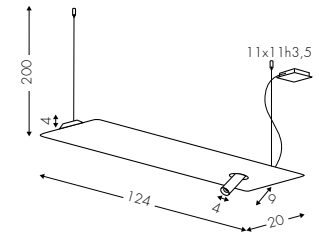

1054EOF

1054EDM

1054EBT

63W 7050lm + 2x7W 2x680lm - 220V

DAI (Push) - 63W 7050lm + 2x7W 2x680lm - 220V

63W 7050lm + 2x7W 2x680lm - 220V

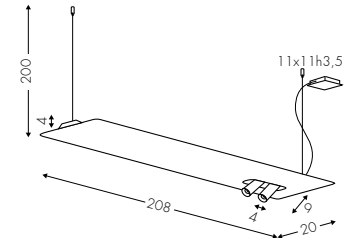

1054HOF

1054HDM

1054HBT

90W 10100lm + 4x7W 4x680lm - 220V

DAI (Push) - 90W 10100lm + 4x7W 4x680lm - 220V

90W 10100lm + 4x7W 4x680lm - 220V

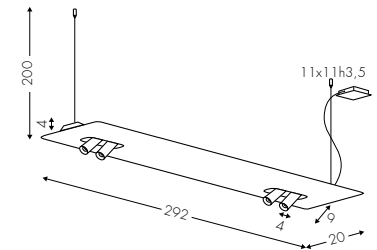

A E28 Satinato - Frosted - Satiniert
24° Ottica - Optic - Optik

A 2700K **B** 3000K



BT Bluetooth - Bluetooth - Bluetooth

A Alimentatore Incorporato - Incorporated Power Supply - Eingebautes Netzteil

Esempio - Example - Beispiel *
4050lm con - with - mit **E28**







RIFLESSA

Lampada a parete lineare ad emissione luminosa indiretta. Sorgenti secondarie a luce diffusa downlight nella versione biemissione. Alimentatore incorporato; struttura in alluminio verniciato.

Linear wall lamp with reflected light emission. Secondary diffused downlight sources in the bi-emission version. Built-in power supply; painted aluminium structure.

Lineare Wandleuchte mit reflektiertem Lichtaustritt. Sekundäre diffuse Downlight-Quellen in der Doppellichtemission Version. Eingebautes Netzteil; Struktur aus lackiertem Aluminium.



2052AOF

15W 1900lm* - 220V

2052ATF

15W 1900lm - 220V



2052COF

23W 2800lm - 220V

2052CDM

DALI (Push) - 23W 2800lm - 220V

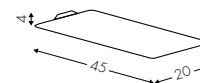

2052DOF

23W 2800lm + 9W 800lm - 220V

2052DDM

DALI (Push) - 23W 2800lm + 9W 800lm - 220V

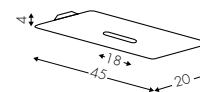

E2 Opale - Opal

● A 2700K ● B 3000K



TF Taglio di Fase - Phase-Cut Dimmer - Phasenabschrittdimmer

A Alimentatore Incorporato - Incorporated Power Supply - Eingebautes Netzteil

Esempio - Example - Beispiel *
1900lm con - with - mit **E2**







RIFLESSA

Lampada da terra lineare ad emissione luminosa indiretta. Alimentatore incorporato; struttura in alluminio verniciato e diffusore in pmma satinato.

Linear floor lamp with indirect light emission. Built-in power supply, painted aluminium structure and satin pmma diffuser.

Lineare Stehleuchte mit indirektem Lichtaustritt. Eingebautes Netzteil, lackierte Aluminiumstruktur und satiniertes pmma-Diffusor.

5052ADM

DIM (Push) - 37W 4500lm* - 220V

5052ABT

37W 4500lm - 220V

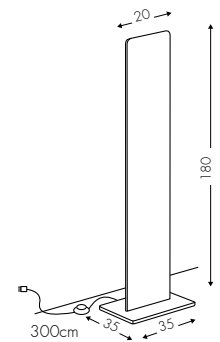
**E28** Satinato - Frosted - Satinert**5054ADM**

DIM (Push) - 37W 4500lm + 2x7W 2x680lm - 220V

5054ABT

37W 4500lm + 2x7W 2x680lm - 220V

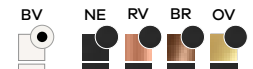
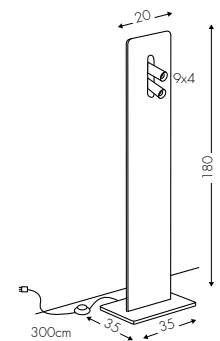
**E28** Satinato - Frosted - Satinert
24° Ottica - Optic - Optik

● A 2700K ● B 3000K

BT Bluetooth - Bluetooth - Bluetooth**A** Alimentatore Incorporato - Incorporated Power Supply - Eingebautes NetzteilEsempio - Example - Beispiel *
4500lm con - with - mit **E28**





La linea Architectural nasce per dare espressione alla luce, in accordo con un design innovativo che abbracci le tendenze di ieri e oggi. La luce viene esaltata secondo nuove prospettive, offrendo al progettista strumenti flessibili e professionali per qualificare ciascun ambiente.

ARCHITECTURAL

The Architectural collection was created to give expression to light, in accordance to an innovative design that embraces yesterday and today trends. Light is enhanced according to new perspectives, offering to the designer flexible and professional tools to qualify every environment.

Die Architectural-Linie wurde entwickelt, um dem Licht Ausdruck zu verleihen durch einem innovativen Design, dass die Trends von gestern und heute widerspiegelt. Das Licht wird durch neue Perspektiven aufgewertet und bietet dem Entwerfer ein flexibles und professionelles Werkzeug, imstande jede Umgebung zu qualifizieren.



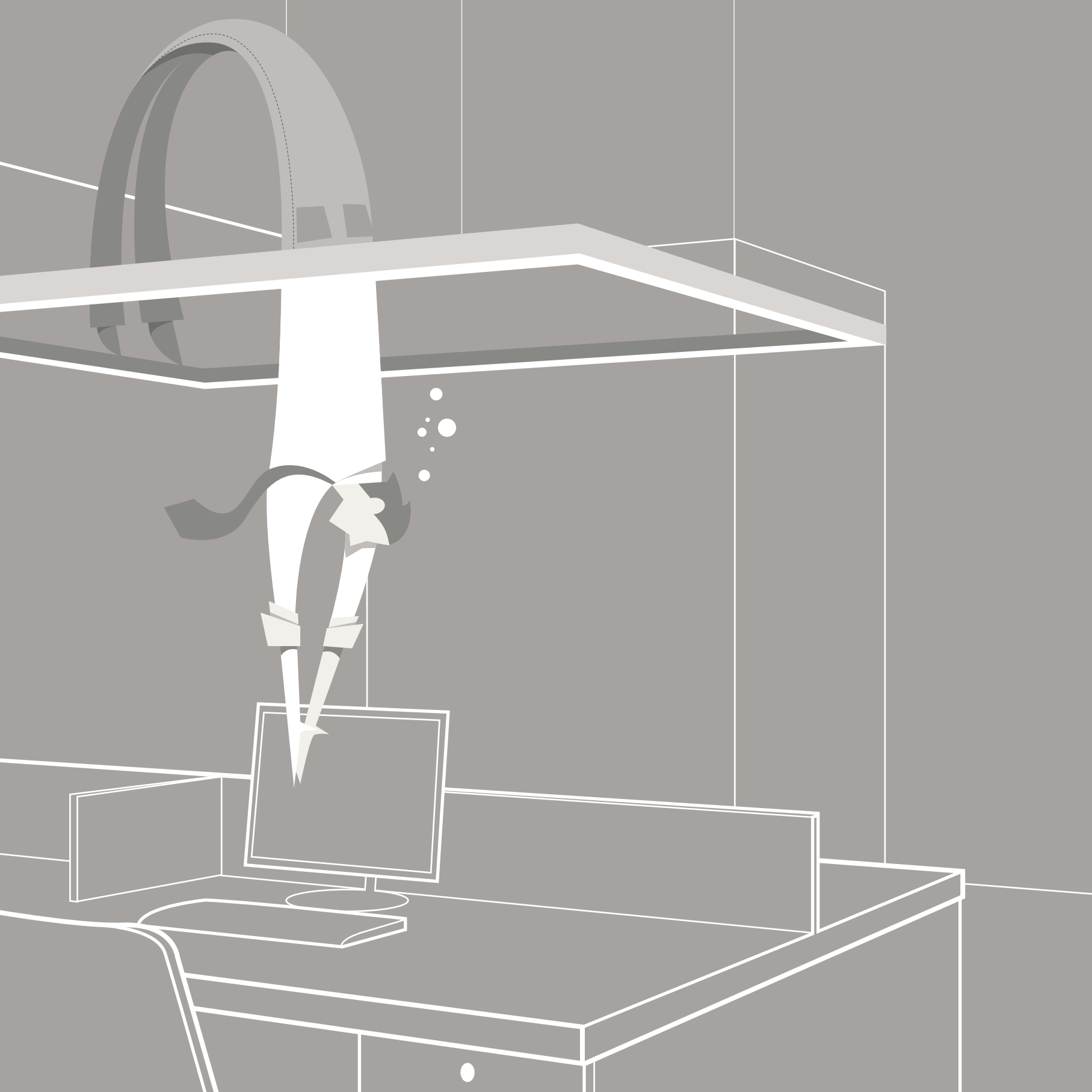



Sistema Led lineare componibile versatile. La flessibilità delle proprie caratteristiche strutturali ed illuminotecniche rende il sistema Miró adatto per l'illuminazione generale in ambito residenziale o tecnica per luoghi di lavoro o attività commerciali.

Linear, modular and versatile Led lamps system. The flexibility of its structural and lighting characteristics makes the Miró system suitable for general lighting in residential or technical areas (like workplaces or commercial activities).

Lineares, modulares und vielseitiges Led Leuchten System. Die Flexibilität seiner strukturellen und Lichtcharakteristik macht das Miró System geeignet für die Allgemeinbeleuchtung in Wohn- oder technischen Bereichen (wie Arbeitsplätze oder kommerzielle Aktivitäten).



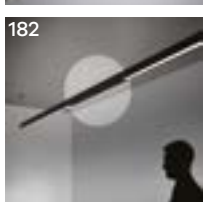
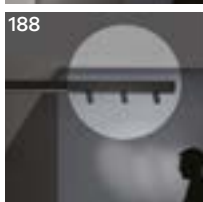
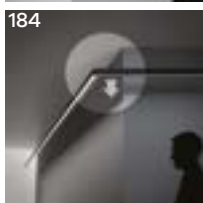

MIRÓ

**Up+Downlight**

112cm	140cm	168cm	197cm	225cm	253cm	281cm
1030B	1030C	1030D	1030E	1030F	1030G	1030H
394cm	506cm	562cm	675cm	787cm	843cm	1012cm
1030L	1030M	1030N	1030O	1030P	1030Q	1030R

Downlight

112cm	140cm	168cm	197cm	225cm	253cm	281cm
1034B	1034C	1034D	1034E	1034F	1034G	1034H
394cm	506cm	562cm	675cm	787cm	843cm	1012cm
1034L	1034M	1034N	1034O	1034P	1034Q	1034R

Uplight

140cm	168cm	197cm	225cm	253cm	281cm
1035C	1035D	1035E	1035F	1035G	1035H
394cm	506cm	562cm	675cm	787cm	843cm
1035L	1035M	1035N	1035O	1035P	1035Q

Geometrical element downlight

59x59cm	56x31cm	56x56cm
1030KGA	1030KGT	1030KGC

Spotlight

56cm	84cm	112cm	197cm	225cm	253cm
1030S2	1030S3	1030S4	1030S5	1030S6	1030S7

Spotlight+Uplight**Darklight**

56cm	84cm	120cm
1046Z	1046A	1046B

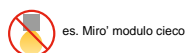
**No-light**

84cm	112cm	140cm
1036A	1036B	1036C

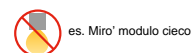
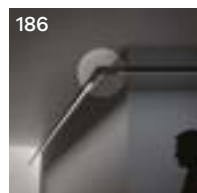
**Geometrical element No-light**

17x17cm	28x17cm	28x28cm
1036KGA	1036KGT	1036KGC

OF	DM
BV	NE
<input type="checkbox"/>	<input type="checkbox"/>
E2	E19
24°	
<input type="radio"/>	B 3000K
<input type="radio"/>	C 4000K

OF	DM
BV	NE
<input type="checkbox"/>	<input type="checkbox"/>
24°	
<input type="radio"/>	B 3000K

OF	DM
BV	NE
<input type="checkbox"/>	<input type="checkbox"/>

indice fotografico



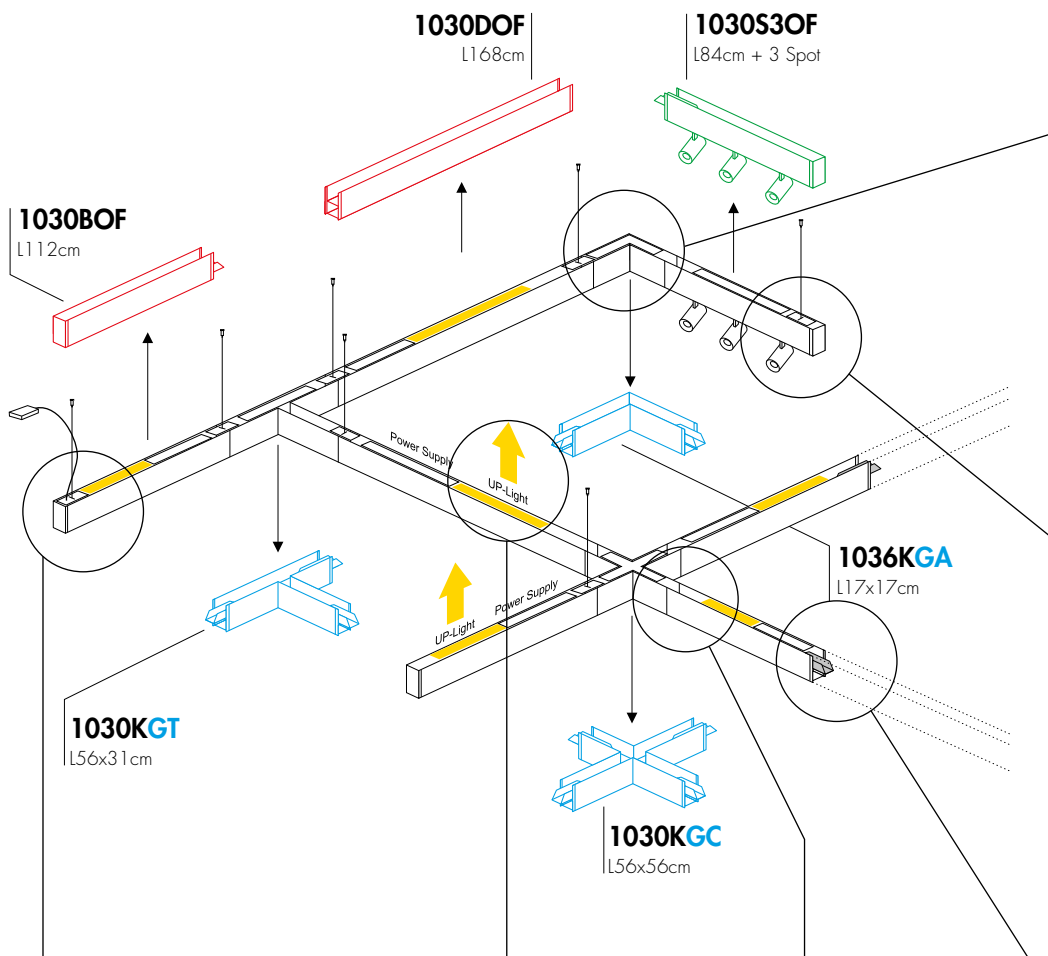



MIRÓ

UPLIGHT + DOWNLIGHT

Sospensione composta da uno o più elementi modulari con emissione diretta ed indiretta.

Disponibile con schermo in Pmma con superficie micropiramidale per limitare i livelli di luminanza o con diffusore in policarbonato opale. Alimentatore integrato nel corpo lampada On/off o dimmerabile DALI (Push).

Suspension modular lighting composed by one or more elements with direct and indirect light emission. Available with Pmma microprismatic diffuser to limit luminance levels or with opal polycarbonate diffuser for general lighting. The On/off or dimmable DALI (Push) power supply is integrated into the structure.

Modulare Hängeleuchte bestehend aus einem oder mehreren Elementen mit direkter und indirekter Lichtemission. Pmma prismatischer Diffusor als Blendschutz Kontrolle oder Opal PC-Diffusor für die Allgemeinbeleuchtung sind erhältlich. On/off oder DALI(Push) dimmbares Netzteil in der Struktur integriert.

1030BOF

35W 3540lm* + 18W 2390lm - 220V

1030BDM

DALI (Push) - 35W 3540lm + 18W 2390lm - 220V

1030COF

44W 4425lm + 18W 2390lm - 220V

1030CDM

DALI (Push) - 44W 4425lm + 18W 2390lm - 220V

1030DOF

53W 5310lm + 18W 2390lm - 220V

1030DDM

DALI (Push) - 53W 5310lm + 18W 2390lm - 220V

1030EOF

62W 6195lm + 18W 2390lm - 220V

1030EDM

DALI (Push) - 62W 6195lm + 18W 2390lm - 220V

UPLIGHT - DOWNLIGHT

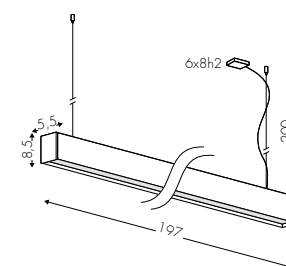
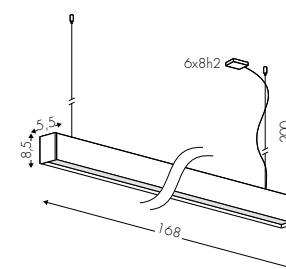
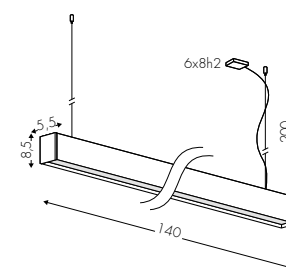
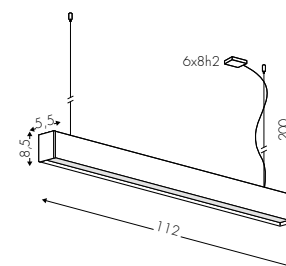

A E2 Opale - Opal
E19 UGR<19 Prism

● B 3000K

○ C 4000K

BV NE



A Alimentatore Incorporato - Incorporated Power Supply - Eingebautes Netzteil

Esempio - Example - Beispiel *

3540lm con - with - mit E19 - 3540lm - 15% con - with - mit E2







1030FOF
1030FDM

70W 7080lm* + 18W 2390lm - 220V
DALI (Push) - 70W 7080lm + 18W 2390lm - 220V

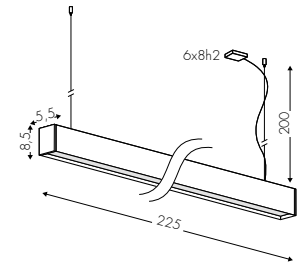

1030GOF
1030GDM

79W 7965lm + 18W 2390lm - 220V
DALI (Push) - 79W 7965lm + 18W 2390lm - 220V

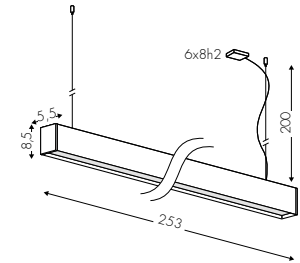

1030HOF
1030HDM

88W 8850lm + 18W 2390lm - 220V
DALI (Push) - 88W 8850lm + 18W 2390lm - 220V

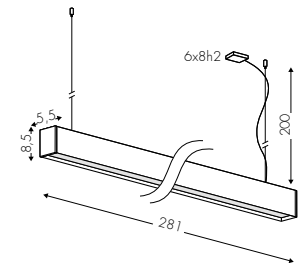

1030LOF
1030LDM

123W 12390lm + 36W 4782lm - 220V
DALI (Push) - 123W 12390lm + 36W 4782lm - 220V

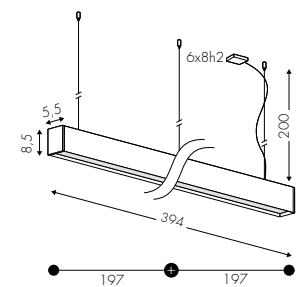

A E2 Opale - Opal
E19 UGR<19 Prism

B 3000K

C 4000K

BV NE

A Alimentatore Incorporato - Incorporated Power Supply - Eingebautes Netzteil

Esempio - Example - Beispiel *
7080lm con - with - mit **E19** - 7080lm - 15% con - with - mit **E2**



UPLIGHT - DOWNLIGHT

1030MOF
1030MDM

158W 15931lm* + 36W 4782lm - 220V
DALI (Push) - 158W 15931lm + 36W 4782lm - 220V

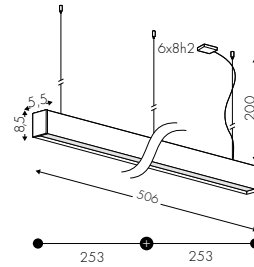

1030NOF
1030NDM

176W 17700lm + 36W 4782lm - 220V
DALI (Push) - 176W 17700lm + 36W 4782lm - 220V

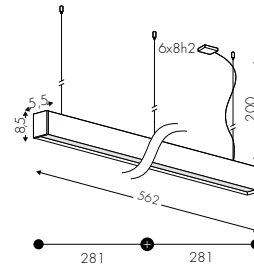

1030OOF
1030ODM

212W 21240lm + 54W 7173lm - 220V
DALI (Push) - 212W 21240lm + 54W 7173lm - 220V

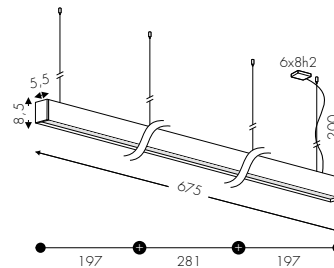

1030POF
1030PDM

246W 24780lm + 54W 7173lm - 220V
DALI (Push) - 246W 24780lm + 54W 7173lm - 220V

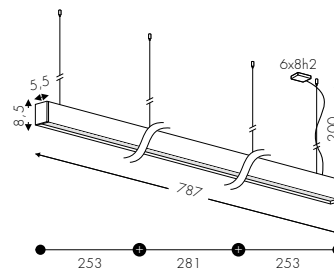

A E2 Opale - Opal
E19 UGR<19 Prism

● B 3000K ○ C 4000K

BV NE

A Alimentatore Incorporato - Incorporated Power Supply - Eingebautes Netzteil

Esempio - Example - Beispiel*

15931lm con - with - mit **E19** - 15931lm - 15% con - with - mit **E2**



1030QOF
1030QDM

264W 26550lm* + 54W 7173lm
DALI (Push) - 264W 26550lm + 54W 7173lm

1030ROF
1030RDM

317W 31861lm + 70W 9564lm - 220V
DALI (Push) - 317W 31861lm + 70W 9564lm - 220V

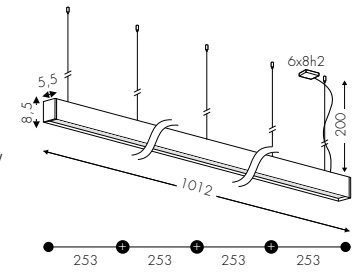
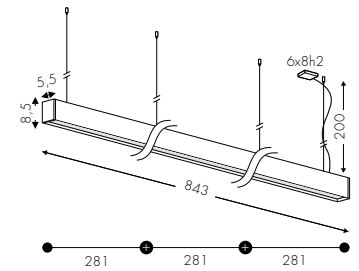

A E2 Opale - Opal
E19 UGR<19 Prism

● B 3000K ○ C 4000K

BV NE
□ □

A Alimentatore Incorporato - Incorporated Power Supply - Eingebautes Netzteil

Esempio - Example - Beispiel *
26550lm con - with - mit **E19** - 26550lm - 15% con - with - mit **E2**





**MIRÓ**
DOWNLIGHT

Sospensione composta da uno o più elementi modulari con emissione diretta, disponibile con schermo in Pmma con superficie micropiramidale per limitare i livelli di luminanza o con diffusore in policarbonato opale. Alimentatore integrato nel corpo lampada On/Off o dimmerabile DALI (Push).

Suspension modular lighting composed by one or more elements with direct light emission. Available with Pmma microprismatic diffuser to limit luminance levels or with opal polycarbonate diffuser for general lighting. The On/Off or dimmable DALI (Push) power supply is integrated into the structure.

Modulare Hängeleuchte bestehend aus einem oder mehreren Elementen mit direkter Lichtemission. Pmma prismatischer Diffusor als Blendschutz Kontrolle oder Opal PC-Diffusor für die Allgemeinbeleuchtung sind erhältlich. On/Off oder dimmbar DALI(Push) Netzteil ist in der Struktur integriert.

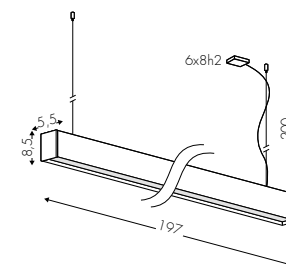
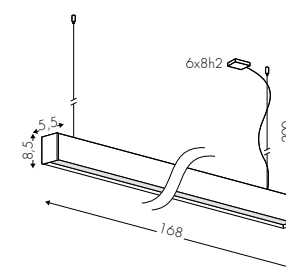
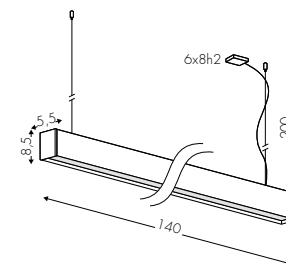
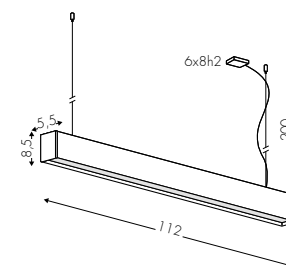
1034BOF
1034BDM35W 3540lm* - 220V
DALI (Push) - 35W 3540lm - 220V**1034COF**
1034CDM44W 4425lm - 220V
DALI (Push) - 44W 4425lm - 220V**1034DOF**
1034DDM53W 5310lm - 220V
DALI (Push) - 53W 5310lm - 220V**1034EOF**
1034EDM62W 6195lm - 220V
DALI (Push) - 62W 6195lm - 220V**DOWNLIGHT****A** E2 Opale - Opal
E19 UGR<19 Prism

● B 3000K

○ C 4000K

BV NE

**A** Alimentatore Incorporato - Incorporated Power Supply - Eingebautes NetzteilEsempio - Example - Beispiel *
3540lm con - with - mit **E19** - 3540lm - 15% con - with - mit **E2**





1034FOF
1034FDM

70W 7080lm* - 220V
DALI (Push) - 70W 7080lm - 220V

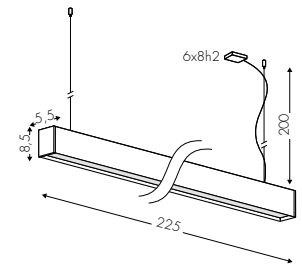

1034GOF
1034GDM

79W 7965lm - 220V
DALI (Push) - 79W 7965lm - 220V

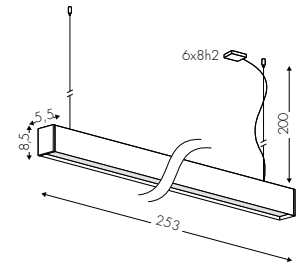

1034HOF
1034HDM

88W 8850lm - 220V
DALI (Push) - 88W 8850lm - 220V

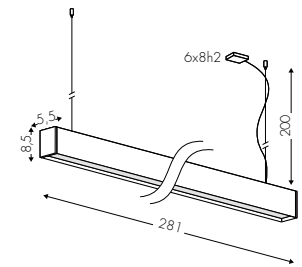

1034LOF
1034LDM

123W 12390lm - 220V
DALI (Push) - 123W 12390lm - 220V

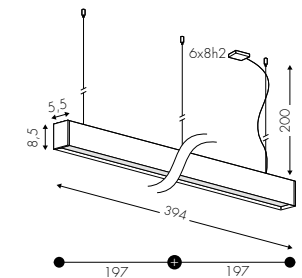

A E2 Opale - Opal
E19 UGR<19 Prism

B 3000K

C 4000K

BV NE



A Alimentatore Incorporato - Incorporated Power Supply - Eingebautes Netzteil

Esempio - Example - Beispiel*
7080lm con - with - mit **E19** - 7080lm - 15% con - with - mit **E2**



DOWNLIGHT

1034MOF
1034MDM

158W 15931lm* - 220V
DALI (Push) - 158W 15931lm - 220V

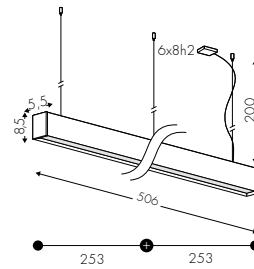

1034NOF
1034NDM

176W 17700lm - 220V
DALI (Push) - 176W 17700lm - 220V

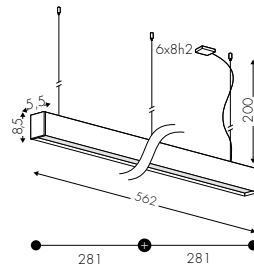

1034OOF
1034ODM

212W 21240lm - 220V
DALI (Push) - 212W 21240lm - 220V

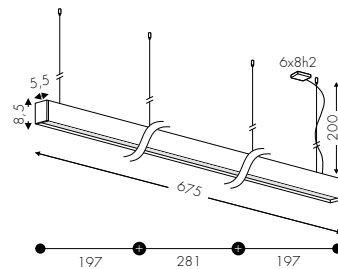

1034POF
1034PDM

246W 24780lm - 220V
DALI (Push) - 246W 24780lm - 220V

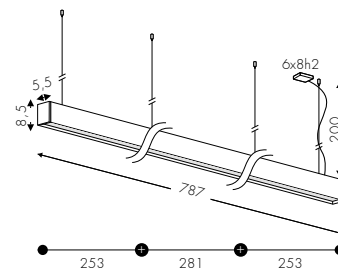

A E2 Opale - Opal
E19 UGR<19 Prism

● B 3000K ○ C 4000K

BV NE
■ ■

A Alimentatore Incorporato - Incorporated Power Supply - Eingebautes Netzteil

Esempio - Example - Beispiel *

15931lm con - with - mit **E19** - 15931lm - 15% con - with - mit **E2**



1034QOF
1034QDM

264W 26550lm* - 220V
DALI (Push) - 264W 26550lm - 220V

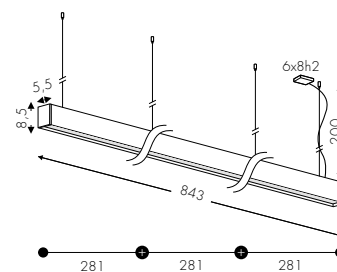

1034ROF
1034RDM

317W 31861lm - 220V
DALI (Push) - 317W 31861lm - 220V

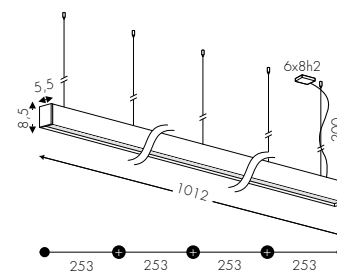

A E2 Opale - Opal
E19 UGR<19 Prism

B 3000K **C** 4000K

BV NE



A Alimentatore Incorporato - Incorporated Power Supply - Eingebautes Netzteil

Esempio - Example - Beispiel *
26550lm con - with - mit **E19** - 26550lm - 15% con - with - mit **E2**





**MIRÓ**
UPLIGHT

Sospensione composta da uno o più elementi modulari con emissione indiretta con diffusore in Pmma satinato. Alimentatore integrato nel corpo lampada On/Off o dimmerabile DALI (Push).

Suspension modular lighting composed by one or more elements with indirect light source. Available with Pmma microprismatic diffuser to limit luminance levels or with opal polycarbonate diffuser for general lighting. The On/Off or dimmable DALI (Push) power supply is integrated into the structure.

Modulare Hängeleuchte, bestehend aus einem oder mehreren Elementen mit indirekter Lichtquelle. Pmma prismatischer Diffusor als Blendschutz Kontrolle oder Opal PC-Diffusor für die Allgemeinbeleuchtung sind erhältlich. On/Off oder dimmbar DALI (Push) Netzteil ist in der Struktur integriert.

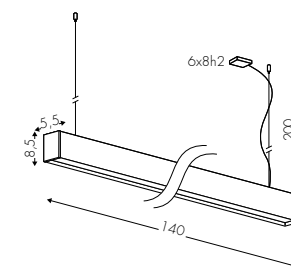
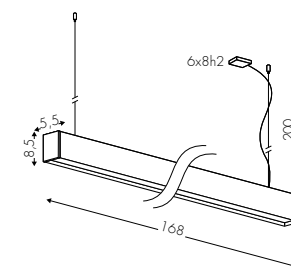
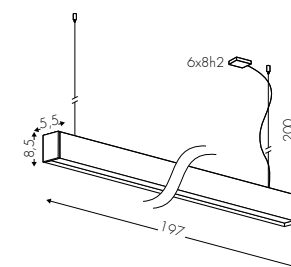
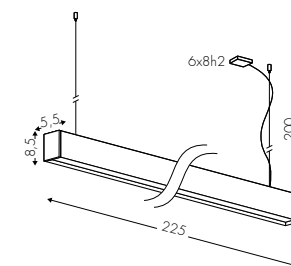
1035COF
1035CDM44W 5620lm* - 220V
DALI (Push) - 44W 5620lm - 220V**1035DOF**
1035DDM55W 7090lm - 220V
DALI (Push) - 55W 7090lm - 220V**1035EOF**
1035EDM67W 9000lm - 220V
DALI (Push) - 67W 9000lm - 220V**1035FOF**
1035FDM78W 10026lm - 220V
DALI (Push) - 78W 10026lm - 220V

E28 Satinato - Frosted - Satiniert



B 3000K



C 4000K

BV NE



Alimentatore Incorporato - Incorporated Power Supply - Eingebautes Netzteil







1035GOF
1035GDM

95W 12226lm* - 220V
DALI (Push) - 95W 12226lm - 220V

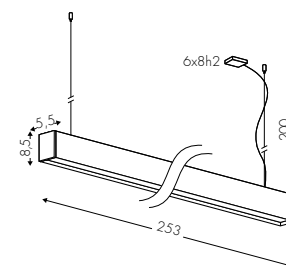

1035HOF
1035HDM

103W 13205lm - 220V
DALI (Push) - 103W 13205lm - 220V

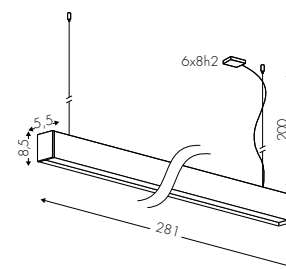

1035LOF
1035LDM

133W 17115lm - 220V
DALI (Push) - 133W 17115lm - 220V

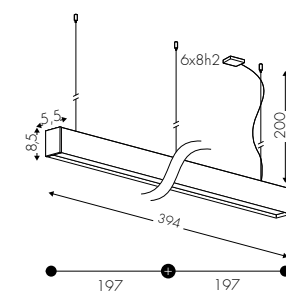

A E28 Satinato - Frosted - Satiniert

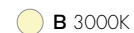

B 3000K **C** 4000K

BV NE



A Alimentatore Incorporato - Incorporated Power Supply - Eingebautes Netzteil

Esempio - Example - Beispiel *
12226lm con - with - mit **E28**



UPLIGHT

1035MOF
1035MDM

190W 24450lm* - 220V
DALI (Push) - 190W 24450lm - 220V

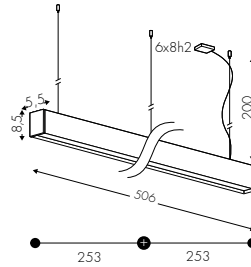

1035NOF
1035NDM

205W 26410lm - 220V
DALI (Push) - 205W 26410lm - 220V

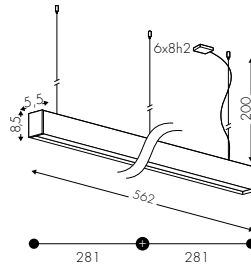

1035OOF
1035ODM

236W 30320lm - 220V
DALI (Push) - 236W 30320lm - 220V

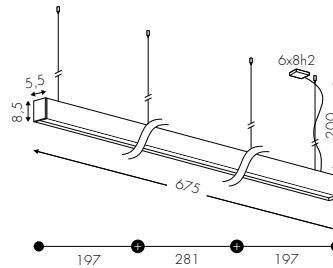

E28 Satinato - Frosted - Satiniert



B 3000K



C 4000K

BV NE



A Alimentatore Incorporato - Incorporated Power Supply - Eingebautes Netzteil

Esempio - Example - Beispiel*
24450lm con - with - mit **E28**



1035POF
1035PDM

293W 37658lm* - 220V
DALI (Push) - 293W 37658lm - 220V

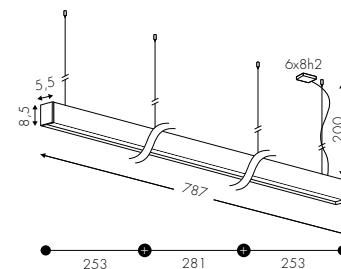

1035QOF
1035QDM

308W 39610lm - 220V
DALI (Push) - 308W 39610lm - 220V

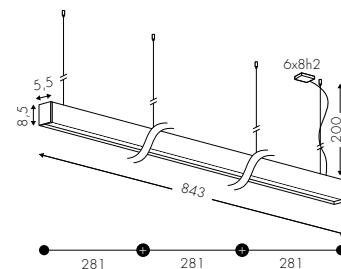

A

E28 Satinato - Frosted - Satiniert

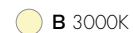

BV NE



A

Alimentatore Incorporato - Incorporated Power Supply - Eingebautes Netzteil

180

indice fotografico

indice famiglia

Esempio - Example - Beispiel *
37658lm con - with - mit E28







MIRÓ

NO-LIGHT LINEAR ELEMENT

Elementi di giunzione lineare non luminosi completi di accessori per la continuità elettrica e meccanica.

No-light linear junction elements completed with accessories for electrical and mechanical continuity.

Lineare Pendelleuchte Blindabdeckung mit Zubehör für elektrische und mechanische Verbindung.

1036AOF

Modulo non luminoso - No light element - Pendelleuchte Blindabdeckung

1036ADM

Modulo non luminoso - No light element - Pendelleuchte Blindabdeckung

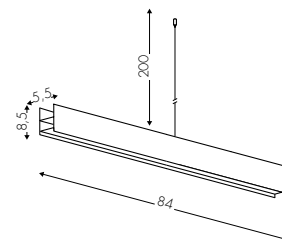
**1036BOF**

Modulo non luminoso - No light element - Pendelleuchte Blindabdeckung

1036BDM

Modulo non luminoso - No light element - Pendelleuchte Blindabdeckung

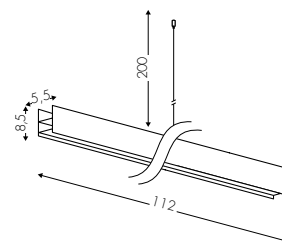
**1036COF**

Modulo non luminoso - No light element - Pendelleuchte Blindabdeckung

1036CDM

Modulo non luminoso - No light element - Pendelleuchte Blindabdeckung

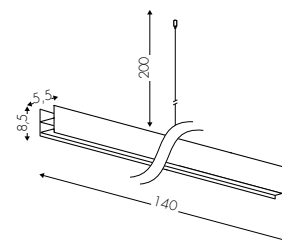

BV NE







MIRÓ GEOMETRICAL ELEMENT

Elementi di giunzione con emissione luminosa diretta disponibile con schermo in Pmma prismaticizzato o diffusore in policarbonato opale. Alimentatore integrato nel corpo lampada On/Off o dimmerabile DALI (Push).

Junction elements available with Pmma microprismatic diffuser for or opal polycarbonate diffuser. The On/Off or dimmable DALI (Push) power supply is integrated into the structure.

Verbindungselemente mit Pmma microprismatisiertem Diffusor oder Opal Polycarbonat Diffusor. On/Off oder dimmbar DALI (Push) Netzteil ist in der Struktur integriert.

1030KGAOF 35W 3540lm* - 220V
1030KGADM DALI (Push) - 35W 3540lm - 220V

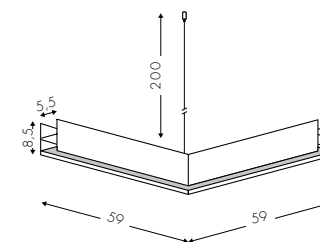

1030KGT0F 26W 2655lm - 220V
1030KGTDM DALI (Push) - 26W 2655lm - 220V

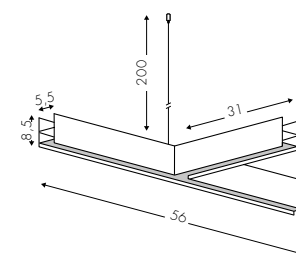

1030KGC0F 35W 3540lm - 220V
1030KGC0DM DALI (Push) - 35W 3540lm - 220V

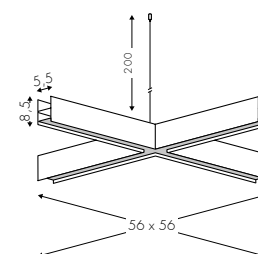

A E2 Opale - Opal
E19 UGR<19 Prism

● B 3000K ○ C 4000K

BV NE



A Alimentatore Incorporato - Incorporated Power Supply - Eingebautes Netzteil

Esempio - Example - Beispiel *
3540lm con - with - mit **E19** - 3540lm - 1.5% con - with - mit **E2**







MIRÓ

NO-LIGHT GEOMETRICAL ELEMENT

Elementi di giunzione geometrici non luminosi completi di accessori per la continuità elettrica e meccanica.

No-light geometrical junction elements completed with accessories for electrical and mechanical continuity.

Geometrische Pendelleuchte Blindabdeckung mit Zubehör für elektrische und mechanische Verbindung.

1036KGAOF Modulo non luminoso - No light element - Pendelleuchte Blindabdeckung

1036KGADM Modulo non luminoso - No light element - Pendelleuchte Blindabdeckung

1036KGTDF Modulo non luminoso - No light element - Pendelleuchte Blindabdeckung

1030KGTDM Modulo non luminoso - No light element - Pendelleuchte Blindabdeckung

1036KGCDF Modulo non luminoso - No light element - Pendelleuchte Blindabdeckung

1036KGCDFM Modulo non luminoso - No light element - Pendelleuchte Blindabdeckung

NO-LIGHT

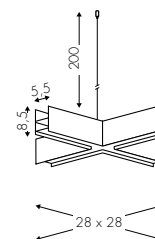
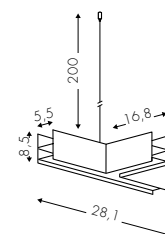
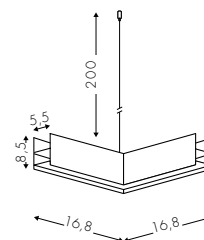

BV NE





**MIRÓ**
SPOTLIGHT ELEMENT

Elementi di giunzione con emissione luminosa diretta, orientabile, concentrata grazie ai proiettori incorporati. Alimentatore integrato nel corpo lampada On/Off o dimmerabile DALI (Push).

Junction element with direct and adjustable light emission. Incorporated focused spotlights. On/off or dimmable DALI (Push) power supply is incorporated.

Verbindungselemente mit direkter und einstellbarer Lichtemission. Eingebaute fokussierte spotlights. On/off oder dimmbar DALI (Push) eingebautes Netzteil.

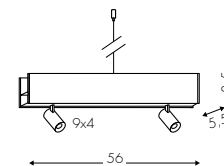
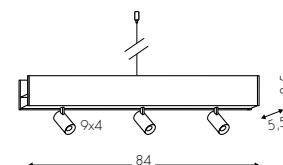
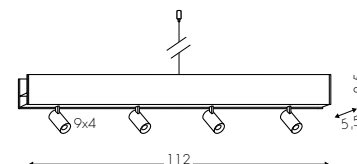
1030S2OF
1030S2DMSpot 2x7W 2x680lm* - 220V
DALI (Push) - Spot 2x7W 2x680lm - 220V**1030S3OF**
1030S3DMSpot 3x7W 3x680lm - 220V
DALI (Push) - Spot 3x7W 3x680lm - 220V**1030S4OF**
1030S4DMSpot 4x7W 4x680lm - 220V
DALI (Push) - Spot 4x7W 4x680lm - 220V**A** 24° Ottica - Optic - Optik● **B** 3000K ○ **C** 4000K**A** Alimentatore Incorporato - Incorporated Power Supply - Eingebautes NetzteilEsempio - Example - Beispiel *
680lm con - with - mit **24°**





1030S5OF

Spot 4x7W 4x680lm* + 18W 2390lm - 220V

1030S5DM

DALI (Push) - Spot 4x7W 4x680lm +
18W 2390lm - 220V

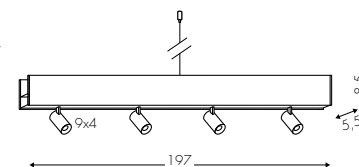

1030S6OF

Spot 5x7W 5x680lm + 18W 2390lm - 220V

1030S6DM

DALI (Push) - Spot 5x7W 5x680lm +
18W 2390lm - 220V

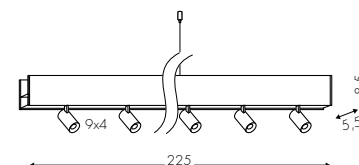

1030S7OF

Spot 5x7W 5x680lm + 18W 2390lm - 220V

1030S7DM

DALI (Push) - Spot 5x7W 5x680lm +
18W 2390lm - 220V

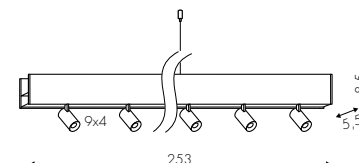

A 24° Ottica - Optic - Optik

● B 3000K ○ C 4000K



A Alimentatore Incorporato - Incorporated Power Supply - Eingebautes Netzteil

Esempio - Example - Beispiel *
680lm con - with - mit 24°

190

indice
fotografico

indice
famiglia





**MIRÓ**
DARKLIGHT

Elemento modulare a sospensione con emissione diretta dotato di ottica darklight per la limitazione dell'abbagliamento. Alimentatore integrato nel corpo lampada On/off o dimmerabile DALI (Push).

This modular suspension lamp with direct light-emission is equipped with darklight optic for glare limitation. The On/off or dimmable DALI (Push) power supply is incorporated in the lamp.

Diese modulare Pendelleuchte mit direkter Lichtemission ist mit einer Darklight-Optik als Blendschutz Kontrolle ausgestattet. On/off oder dimmbar DALI (Push) eingebautes Netzteil.

**1046ZOF**

9W 900lm* - 220V

1046ZDM

DALI (Push) - 9W 900lm - 220V

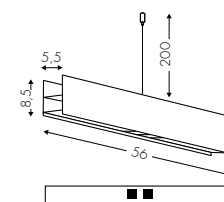
**1046AOF**

13W 1500lm - 220V

1046ADM

DALI (Push) - 13W 1500lm - 220V

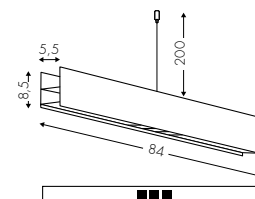
**1046BOF**

2x9W 2x900lm - 220V

1046BDM

DALI (Push) - 2x9W 2x900lm - 220V

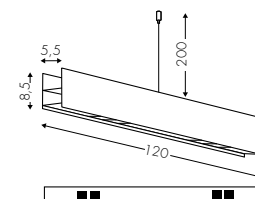

24° Ottica - Optic - Optik

B 3000K

BV NE



Alimentatore Incorporato - Incorporated Power Supply - Eingebautes Netzteil







Downlight

84cm	112cm	140cm	168cm	197cm	225cm	253cm	281cm
3030A	3030B	3030C	3030D	3030E	3030F	3030G	3030H
394cm	506cm	562cm	675cm	787cm	843cm	1012cm	
3030L	3030M	3030N	3030O	3030P	3030Q	3030R	

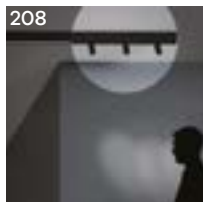

Spotlight

56cm	84cm	112cm	197cm	225cm	253cm
3030S2	3030S3	3030S4	3030S5	3030S6	3030S7



Geometrical element downlight

59*59cm	56*31cm	56*56cm
3030KGA	3030KGT	3030KGC



Darklight

56cm	84cm	120cm
3046Z	3046A	3046B



No-light

84cm	112cm	140cm
3036A	3036B	3036C



Geometrical element No-light

17x17cm	28x17cm	28x28cm
3036KGA	3036KGT	3036KGC



OF	DM
BV	NE
<input type="checkbox"/>	<input type="checkbox"/>
E2	E19
24°	
<input type="radio"/> B 3000K	
<input type="radio"/> C 4000K	

OF	DM
BV	NE
<input type="checkbox"/>	<input type="checkbox"/>
24°	
<input type="radio"/> B 3000K	

OF	DM
BV	NE
<input type="checkbox"/>	<input type="checkbox"/>



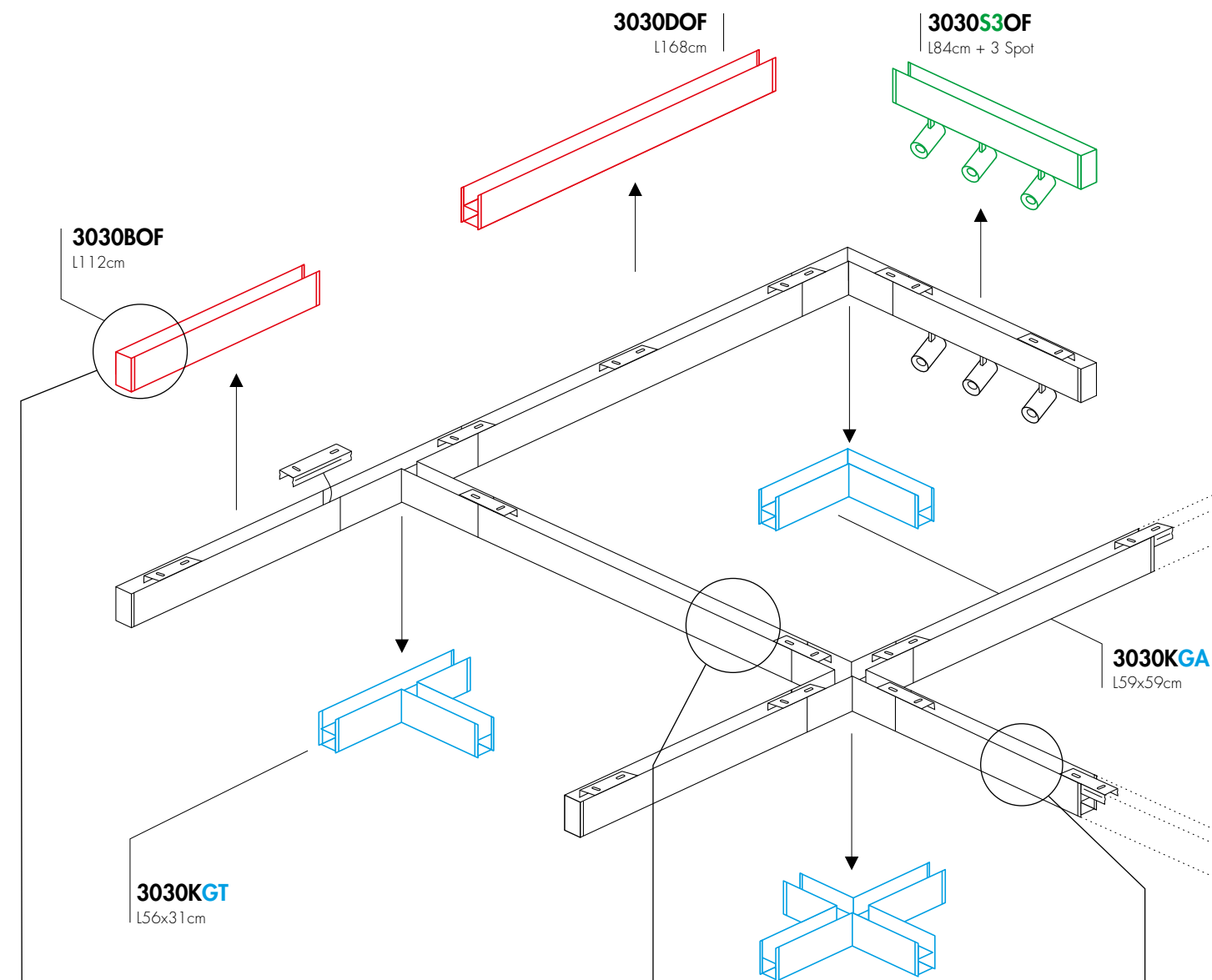

**MIRÓ**
DOWNLIGHT

Sistema a plafone composto da uno o più elementi modulari con emissione diretta, disponibile con schermo in Pmma con superficie micropiramidale per limitare i livelli di luminanza o con diffusore in policarbonato opale. Alimentatore integrato nel corpo lampada On/Off o dimmerabile DALI (Push).

Suspension modular lighting composed by one or more elements with direct light emission. Available with Pmma microprismatic diffuser to limit luminance levels or with opal polycarbonate diffuser for general lighting. The On/off or dimmable DALI (Push) power supply is integrated into the structure.

Modulare Hängeleuchte, bestehend aus einem oder mehreren Elementen mit direkter Lichtemission. Pmma prismatischer Diffusor als Blendschutz Kontrolle oder Opal PC-Diffusor für die Allgemeinbeleuchtung sind erhältlich. On/off oder DALI(Push) eingebautes Netzteil.

3030AOF 26W 2655lm* - 220V
3030ADM DALI (Push) - 26W 2655lm - 220V

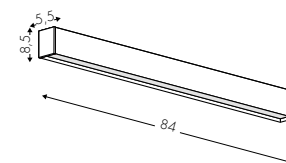

3030BOF 35W 3540lm - 220V
3030BDM DALI (Push) - 35W 3540lm - 220V

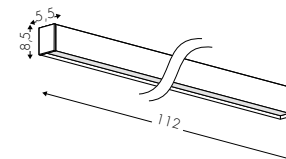

3030COF 44W 4425lm - 220V
3030CDM DALI (Push) - 44W 4425lm - 220V

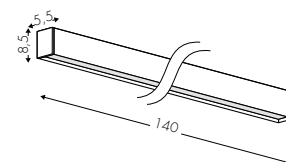

3030DOF 53W 5310lm - 220V
3030DDM DALI (Push) - 53W 5310lm - 220V

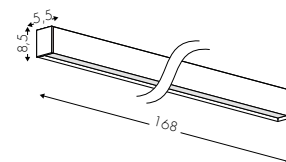

A E2 Opale - Opal
E19 UGR<19 Prism

B 3000K

C 4000K

BV **NE**

A Alimentatore Incorporato - Incorporated Power Supply - Eingebautes Netzteil

Esempio - Example - Beispiel *
2655lm con - with - mit **E19** - 2655lm - 15% con - with - mit **E2**







3030EOF
3030EDM

62W 6195lm* - 220V
DALI (Push) - 62W 6195lm - 220V

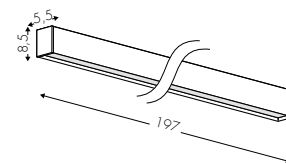

3030FOF
3030FDM

70W 7080lm - 220V
DALI (Push) - 70W 7080lm - 220V

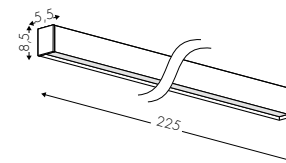

3030GOF
3030GDM

79W 7965lm - 220V
DALI (Push) - 79W 7965lm - 220V

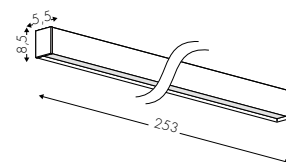

3030HOF
3030HDM

88W 8850lm - 220V
DALI (Push) - 88W 8850lm - 220V

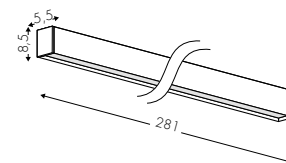

A E2 Opale - Opal
E19 UGR<19 Prism

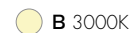

A Alimentatore Incorporato - Incorporated Power Supply - Eingebautes Netzteil

Esempio - Example - Beispiel *
6195lm con - with - mit **E19** - 6195lm - 15% con - with - mit **E2**



DOWNLIGHT

3030LOF
3030LDM

123W 12390lm* - 220V
DALI (Push) - 123W 12390lm - 220V

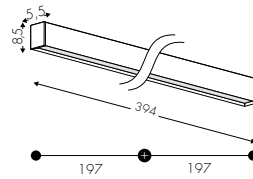

3030MOF
3030MDM

158W 15931lm - 220V
DALI (Push) - 158W 15931lm - 220V

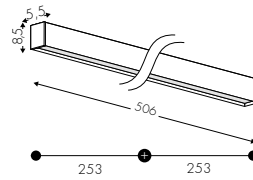

3030NOF
3030NDM

176W 17700lm - 220V
DALI (Push) - 176W 17700lm - 220V

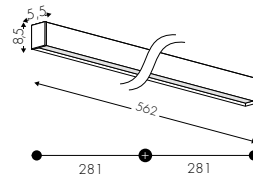

3030OOF
3030ODM

212W 21240lm - 220V
DALI (Push) - 212W 21240lm - 220V

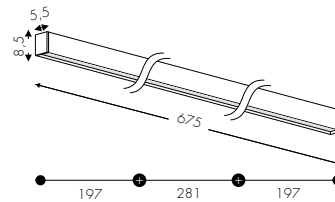

A E2 Opale - Opal
E19 UGR<19 Prism



B 3000K



C 4000K



A Alimentatore Incorporato - Incorporated Power Supply - Eingebautes Netzteil

Esempio - Example - Beispiel *

12390lm con - with - mit **E19** - 12390lm - 1.5% con - with - mit **E2**



3030POF
3030PDM

246W 24780lm* - 220V
DALI (Push) - 246W 24780lm - 220V

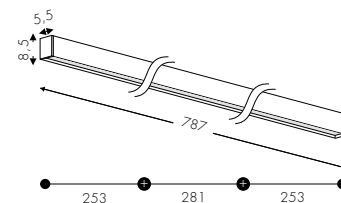

3030QOF
3030QDM

264W 26550lm - 220V
DALI (Push) - 264W 26550lm - 220V

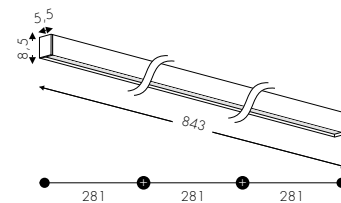

3030ROF
3030RDM

317W 31861lm - 220V
DALI (Push) - 317W 31861lm - 220V

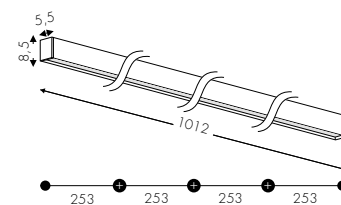

A E2 Opale - Opal
E19 UGR<19 Prism

● B 3000K ○ C 4000K

BV NE
□ □

A Alimentatore Incorporato - Incorporated Power Supply - Eingebautes Netzteil

Esempio - Example - Beispiel *
24780lm con - with - mit **E19** - 21240lm - 15% con - with - mit **E2**

200

indice
fotografico

indice
famiglia







MIRÓ

NO-LIGHT LINEAR ELEMENT

Elementi di giunzione lineare non luminosi completi di accessori per la continuità elettrica e meccanica.

No-light linear junction elements completed with accessories for electrical and mechanical continuity.

Lineare Deckenleuchte Blindabdeckung mit Zubehör für elektronische und mechanische Verbindung.

3036AOF Modulo non luminoso - No light element - Deckenleuchte Blindabdeckung

3036ADM Modulo non luminoso - No light element - Deckenleuchte Blindabdeckung

3036BOF Modulo non luminoso - No light element - Deckenleuchte Blindabdeckung

3036BDM Modulo non luminoso - No light element - Deckenleuchte Blindabdeckung

3036COF Modulo non luminoso - No light element - Deckenleuchte Blindabdeckung

3036CDM Modulo non luminoso - No light element - Deckenleuchte Blindabdeckung

NO-LIGHT

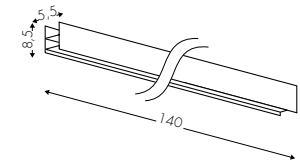
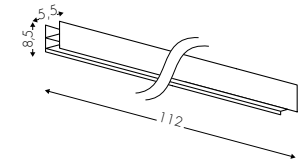
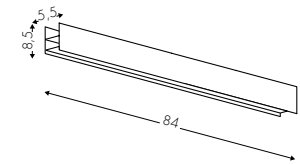





MIRÓ GEOMETRICAL ELEMENT

Elementi di giunzione con emissione luminosa diretta disponibile con schermo in Pmma prismaticizzato o diffusore in Policarbonato opale. Alimentatore integrato nel corpo lampada On/off o dimmerabile DALI (Push).

Junction elements available with Pmma microprismatic diffuser or opal PC diffuser. The On/off or dimmable DALI (Push) power supply is integrated into the structure.

Verbindungselemente mit Pmma microprismatisiertem Diffusor oder Opal-PC-Diffusor. On/off oder dimmbar DALI-(Push) Netzteil ist in der Struktur integriert.

3030KGAOF 35W 3540lm* - 220V
3030KGADM DALI (Push) - 35W 3540lm - 220V

3030KGTDF 26W 2655lm - 220V
3030KGTDM DALI (Push) - 26W 2655lm - 220V

3030KGCDF 35W 3540lm - 220V
3030KGCDFM DALI (Push) - 35W 3540lm - 220V

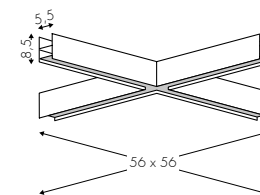
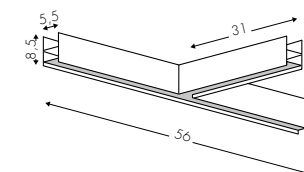
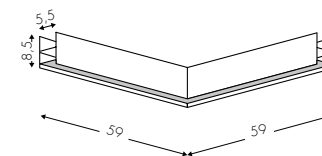

A E2 Opale - Opal
E19 UGR<19 Prism

● B 3000K ○ C 4000K

BV NE



A Alimentatore Incorporato - Incorporated Power Supply - Eingebautes Netzteil

Esempio - Example - Beispiel *
3540lm con - with - mit **E19** - 3540lm - 15% con - with - mit **E2**







MIRÓ

NO-LIGHT GEOMETRICAL ELEMENT

Elementi di giunzione geometrici non luminosi completi di accessori per la continuità elettrica e meccanica.

No-light geometrical junction elements completed with accessories for electrical and mechanical continuity.

Geometrische Deckenleuchte Blindabdeckung mit Zubehör für elektrische oder mechanische Verbindung.

3036KGAOF Modulo non luminoso - No light element - No licht element

3036KGADM Modulo non luminoso - No light element - No licht element

3036KGT0F Modulo non luminoso - No light element - No licht element

3036KGTDM Modulo non luminoso - No light element - No licht element

3036KGC0F Modulo non luminoso - No light element - No licht element

3036KGC0DM Modulo non luminoso - No light element - No licht element

DOWNLIGHT

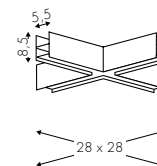
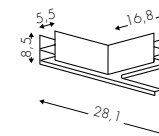
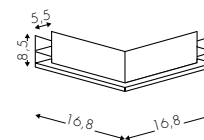

BV NE





**MIRÓ**
SPOTLIGHT ELEMENT

Elementi di giunzione con emissione luminosa diretta, orientabile, concentrata grazie ai proiettori incorporati. Alimentatore integrato nel corpo lampada On/Off o dimmerabile DALI (Push).

Junction element with direct and adjustable light emission. Incorporated focused spotlights. On/off or dimmable DALI (Push) power supply is incorporated.

Verbindungselemente mit direkter und einstellbarer Lichtemission. Eingebaute fokussierte spotlights. On/off oder dimmbar DALI (Push) eingebautes Netzteil.

**3030S2OF**

Spot 2x7W 2x680lm* - 220V

3030S2DM

DALI (Push) - Spot 2x7W 2x680lm - 220V

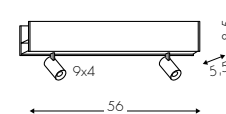
**3030S3OF**

Spot 3x7W 3x680lm - 220V

3030S3DM

DALI (Push) - Spot 3x7W 3x680lm - 220V

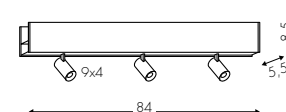
**3030S4OF**

Spot 4x7W 4x680lm - 220V

3030S4DM

DALI (Push) - Spot 4x7W 4x680lm - 220V

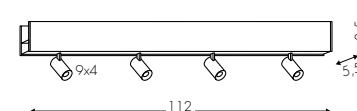
**3030S5OF**

Spot 5x7W 5x680lm - 220V

3030S5DM

DALI (Push) - Spot 5x7W 5x680lm - 220V

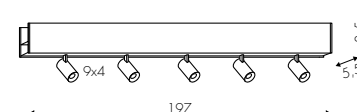

24° Ottica - Optic - Optik

● B 3000K

○ C 4000K

**A** Alimentatore Incorporato - Incorporated Power Supply - Eingebautes NetzteilEsempio - Example - Beispiel *
680lm con - with - mit 24°

SPOTLIGHT

3030S6OF

Spot 5x7W 5x680lm - 220V

3030S6DM

DALI (Push) - Spot 5x7W 5x680lm - 220V

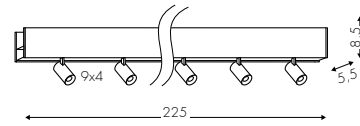

3030S7OF

Spot 5x7W 5x680lm - 220V

3030S7DM

DALI (Push) - Spot 5x7W 5x680lm - 220V

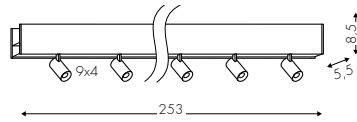

**MIRÓ**
DARKLIGHT

Elemento modulare a plafone con emissione diretta dotato di ottica darklight per la limitazione dell'abbagliamento. Alimentatore integrato nel corpo lampada On/off o dimmerabile DALI (Push).

This modular ceiling lamp with direct light source is equipped with darklight optic for glare limitation. The On/off or dimmable DALI (Push) power supply is incorporated in the lamp.

Diese modulare Pendelleuchte mit direkter Lichtemission ist mit einer Darklight-Optik als Blendschutz Kontrolle ausgestattet. On/off oder dimmbar DALI (Push) eingebautes Netzteil.

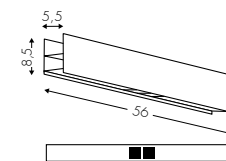
**DARKLIGHT****3046ZOF**

9W 900lm* - 220V

3046ZDM

DALI (Push) - 9W 900lm - 220V

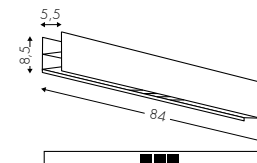
**3046AOF**

13W 1500lm - 220V

3046ADM

DALI (Push) - 13W 1500lm - 220V

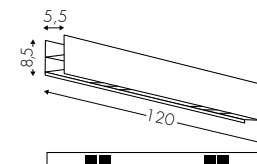
**3046BOF**

2x9W 2x900lm - 220V

3046BDM

DALI (Push) - 2x9W 2x900lm - 220V



24° Ottica - Optic - Optik

B 3000K

BV NE



Alimentatore Incorporato - Incorporated Power Supply - Eingebautes Netzteil







 
MADE in ITALY

Nella versione up+down a parete Mirò diventa uno strumento versatile ed efficiente per l'illuminazione radente delle superfici perimetrali. In questo modo è possibile valorizzare la stanza aumentandone la dimensione percepita.

In the up+down wall light version Mirò becomes a versatile and efficient tool for grazing lighting of perimeter surfaces. In this way it is possible to enhance the room and increase its perceived size.

In der Up+Down-Wandleuchte Variante wird Mirò zu einem vielseitigen und effizienten Werkzeug für die streifende Beleuchtung von Begrenzungsflächen. Auf diese Weise ist es möglich, den Raum durch Vergrößerung seiner wahrgenommenen Größe aufzuwerten.



A 3D geometric graphic featuring a dark grey cube on the left side, with a light grey background. The cube is positioned in the lower-left quadrant, and its top surface is highlighted with a white glow. The background is divided into two shades of grey by a diagonal line running from the top-left to the bottom-right.

MIRÓ APPLIQUE



MIRÓ APPLIQUE

UPLIGHT + DOWNLIGHT

Applique composta da uno o più elementi modulari con emissione luminosa diretta ed indiretta disponibile con schermo in PC opale. Alimentatore integrato nel corpo lampada On/Off o dimmerabile DALI (Push).

Wall lighting fixture composed by one or more modular elements for direct and indirect lighting; available with opal PC diffuser for general lighting. On/Off or dimmable DALI (Push) power supply integrated into the structure.

Wandleuchte für direkte und indirekte Beleuchtung; zusammengesetzt aus einen oder mehreren modularen Elementen; erhältlich mit Opal-PC-Diffusor für die Allgemeinbeleuchtung. On/Off oder DALI(Push) dimmbares Netzteil in der Struktur integriert.

2030EOF
2030EDM

44W 4570lm* + 44W 4570lm - 220V
DALI(Push) 44W 4570lm + 44W 4570lm - 220V

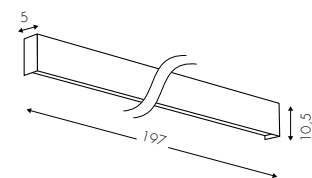

2030FOF
2030FDM

50W 5200lm + 50W 5200lm - 220V
DALI(Push) 50W 5200lm + 50W 5200lm - 220V

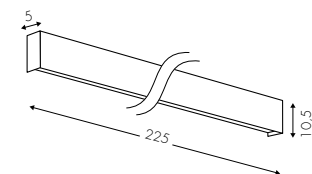

2030GOF
2030GDM

56W 5820lm + 56W 5820lm - 220V
DALI(Push) 56W 5820lm + 56W 5820lm - 220V

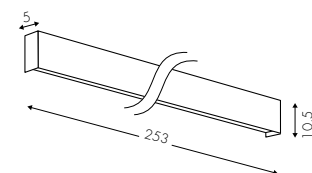

2030HOF
2030HDM

63W 6500lm + 63W 6500lm - 220V
DALI(Push) 63W 6500lm + 63W 6500lm - 220V

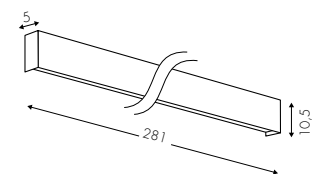

A E2 Opale - Opal

A 2700K

B 3000K

C 4000K

BV NE SO



Alimentatore Incorporato - Incorporated Power Supply - Eingebautes Netzteil







Alimentatore incluso ispezionabile
Inspectable power supply included
Inspektionsfähiges Netzteil enthalten

2030LOF
2030LDM

88W 9140lm* + 88W 9140lm - 220V
DALI(Push) 88W 9140lm + 88W 9140lm - 220V

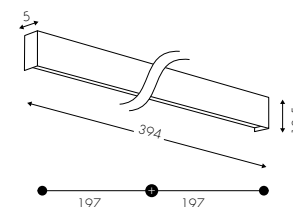

2030MOF
2030MDM

112W 11640lm + 112W 11640lm - 220V
DALI(Push) 112W 11640lm + 112W 11640lm - 220V

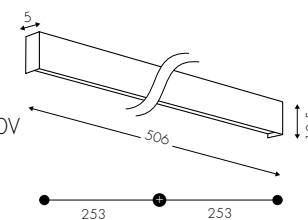

2030NOF
2030NDM

126W 13000lm + 126W 13000lm - 220V
DALI(Push) 126W 13000lm + 126W 13000lm - 220V

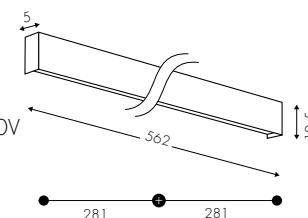

2030OOF
2030ODM

151W 15640lm + 151W 15640lm - 220V
DALI(Push) 151W 15640lm + 151W 15640lm - 220V

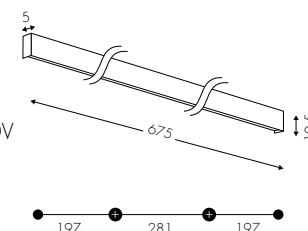

A E2 Opale - Opal

A 2700K

B 3000K

C 4000K

BV **NE** **SO**



Alimentatore Incorporato - Incorporated Power Supply - Eingebautes Netzteil



UPLIGHT - DOWNLIGHT

2030POF
2030PDM

175W 18140lm* + 175W 18140lm - 220V
DALI(Push) 175W 18140lm + 175W 18140lm - 220V

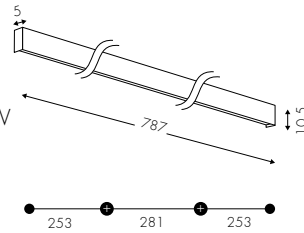

2030QOF
2030QDM

189W 19500lm + 189W 19500lm - 220V
DALI(Push) 189W 19500lm + 189W 19500lm - 220V

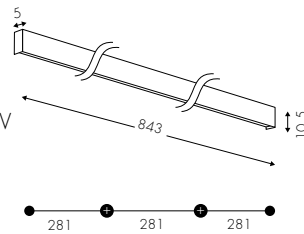

2030ROF
2030ODM

224W 23280lm + 224W 23280lm - 220V
DALI(Push) 224W 23280lm + 224W 23280lm - 220V

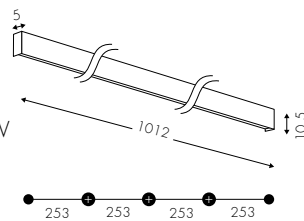

Sovrapposizione moduli senza fuga di luce
Overlapping modules without light leakage
Überlappende Module ohne Lichtverlust



A E2 Opale - Opal

A 2700K

B 3000K

C 4000K

BV NE SO

A Alimentatore Incorporato - Incorporated Power Supply - Eingebautes Netzteil

Esempio - Example - Beispiel*
18140lm con - with - mit **E2**



 
MADE in ITALY

Sistema a sospensione componibile per l'illuminazione diretta. La semplicità costruttiva e le funzionalità essenziali rendono Emme24 il sistema ideale per creare composizioni luminose, efficienti e dal costo contenuto.

Modular suspension lighting system with direct emission. The constructive simplicity and essential functionalities make Emme24 the ideal system to create cheap but efficient lighting compositions.

Modulares Hängebeleuchtungssystem mit direkter Emission. Die konstruktive Einfachheit und die wesentlichen Funktionalitäten machen Emme24 zum idealen System, um preiswerte, aber effiziente Beleuchtungskompositionen zu schaffen.





EMME'24



EMME 24

EXAMPLES OF COMPOSITION

Gli elementi Emme24 a 24VDC possono essere abbinati liberamente in funzione delle necessità progettuali; la composizione può essere alimentata tramite PowerUnit on-off o dimmerabile opportunamente dimensionata.

Emme24 24VDC elements can be freely combined according to the design needs; the composition can be powered by an appropriately sized on-off PowerUnit or Dimmable.

Die 24VDC Emme24-Elemente können je nach Plan Bedürfnissen frei kombiniert werden; die Zusammensetzung kann durch angemessene On/off oder dimmbares Netzteil bedient werden.

COMPOSIZIONE CODICI DI ACQUISTO
CODES COMPOSITION
ZUSAMMENSETZUNG DES CODES

1pz	1037MBVE2B	pag. 225
1pz	9037BTFBV	pag. 232

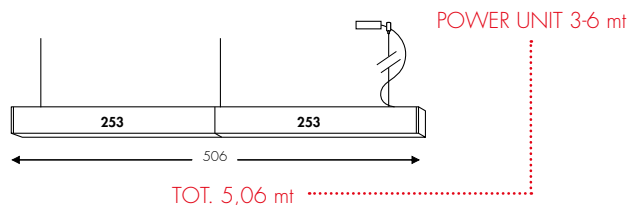

COMPOSIZIONE CODICI DI ACQUISTO
CODES COMPOSITION
ZUSAMMENSETZUNG DES CODES

1pz	1037LBVE2B	pag. 225
1pz	1037KGABVE2B	pag. 231
1pz	1037EBVE2B	pag. 222
1pz	9037CDM	pag. 232

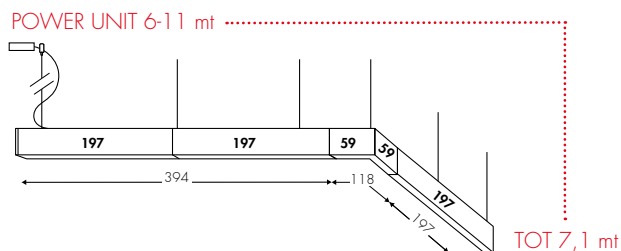

COMPOSIZIONE CODICI DI ACQUISTO
CODES COMPOSITION
ZUSAMMENSETZUNG DES CODES

2pz	1037RNEE2B	pag. 226
2pz	9037COF	pag. 232





MIRO'

EMME 24

NEW

5,5 x H 8,3cm

4,3 x H 6,5cm

3160lm/mt
220VAC

Moduli led rigidi/Rigid led modules/
starre LED-Module

Driver incorporato/built-in driver/eingebauter Treiber

2000lm/mt
24VDC

Moduli led rigidi/Rigid led modules/
starre LED-Module

Driver Onoff - DALI escluso remoto/
Onoff driver - DALI excluded remotely/
Driver Onoff - DALI aus der Ferne ausgeschlossen



EMME 24



CUSTOM 

1037B

25W 2240lm* - 24VDC

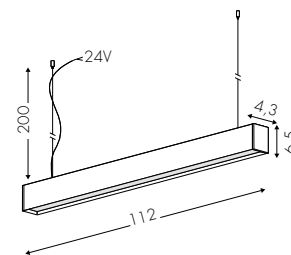

1037C

31W 2800lm - 24VDC

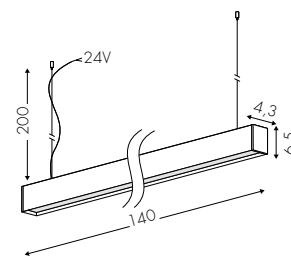

1037D

37W 3360lm - 24VDC

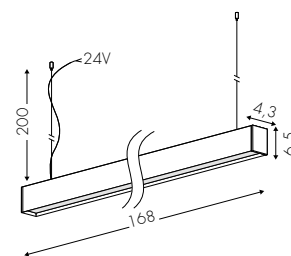

1037E

44W 3940lm - 24VDC

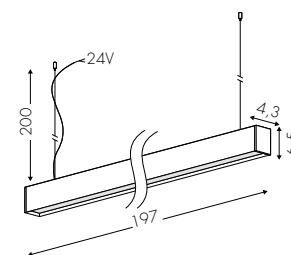

ALIMENTATORE
NON INCLUSO



 E2 Opale - Opal E19 UGR<19 Prism

 B 3000K

 C 4000K

BV  NE 

 Alimentatore non incluso - Power Supply not included - Netzteil nicht inbegriffen

Esempio - Example - Beispiel *

2240lm con - with - mit E19 - 2240lm - 15% con - with - mit E2







1037F

50W 4500lm* - 24VDC

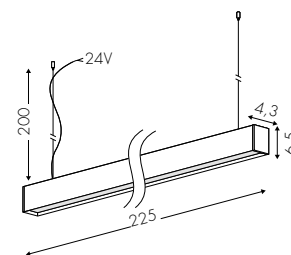

1037G

56W 5060lm - 24VDC

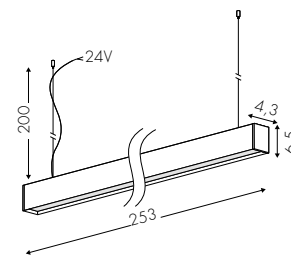

1037H

62W 5620lm - 24VDC

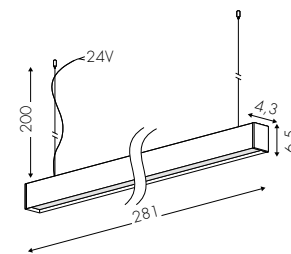

ALIMENTATORE
NON INCLUSO



A E2 Opale - Opal E19 UGR<19 Prism

B 3000K

C 4000K



A Alimentatore non incluso - Power Supply not included - Netzteil nicht inbegriffen

Esempio - Example - Beispiel *

4500lm con - with - mit **E19** - 4500lm - 1.5% con - with - mit **E2**



DOWNLIGHT

1037L

87W 7880lm* - 24VDC

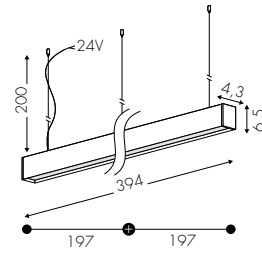

1037M

111W 10120lm - 24VDC

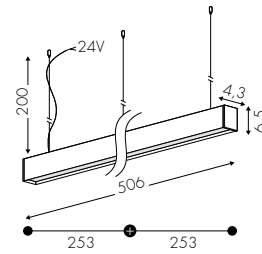

1037N

124W 11240lm - 24VDC

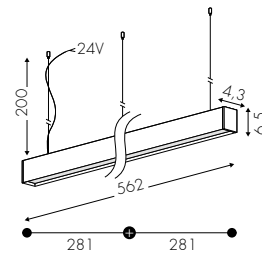

E2 Opale - Opal E19 UGR<19 Prism



B 3000K



C 4000K

BV NE



**ALIMENTATORE
NON INCLUSO**

A Alimentatore non incluso - Power Supply not included - Netzteil nicht inbegriffen

Esempio - Example - Beispiel *

7880lm con - with - mit **E19** - 7880lm - 15% con - with - mit **E2**



1037O

148,5W 13500lm* - 24VDC

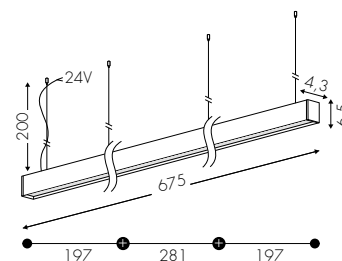

1037P

173W 15740lm - 24VDC

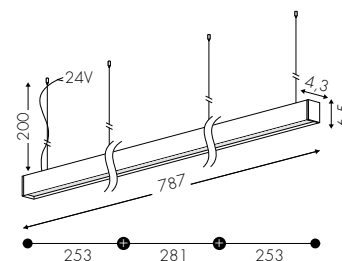

1037Q

185W 16860lm - 24VDC

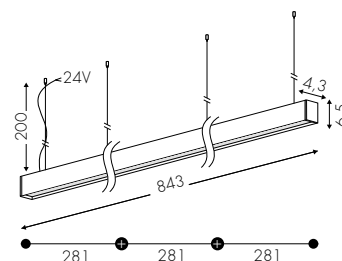

1037R

223W 20240lm - 24VDC

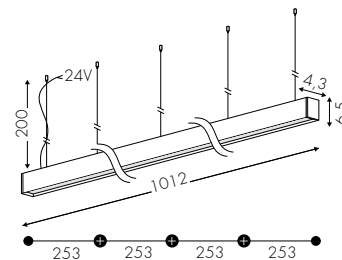

ALIMENTATORE
NON INCLUSO



A E2 Opale - Opal E19 UGR<19 Prism

B 3000K

C 4000K

BV NE

A Alimentatore non incluso - Power Supply not included - Netzteil nicht inbegriffen

Esempio - Example - Beispiel *

13500lm con - with - mit **E19** - 13500lm - 15% con - with - mit **E2**



DOWNLIGHT

1037KGA

25W 2240lm* - 24VDC

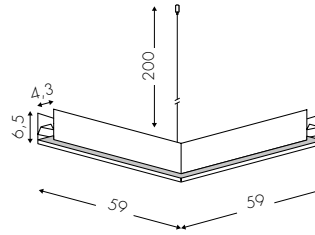

E2 Opale - Opal E19 UGR<19 Prism



B 3000K



C 4000K

BV NE



ALIMENTATORE
NON INCLUSO

 Alimentatore non incluso - Power Supply not included - Netzteil nicht inbegriffen

Esempio - Example - Beispiel *

2240lm con - with - mit E19 - 2240lm - 15% con - with - mit E2



EMME 24



CUSTOM

3037B

25W 2240lm* - 24VDC

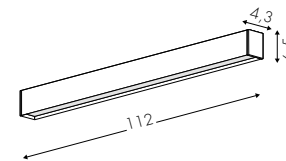

3037C

31W 2800lm - 24VDC

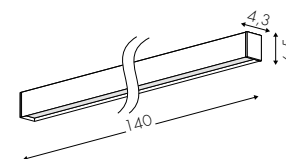

3037D

37W 3360lm - 24VDC

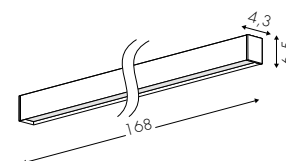

3037E

44W 3940lm - 24VDC

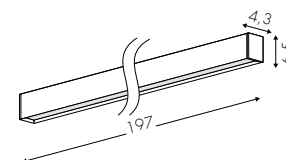

**ALIMENTATORE
NON INCLUSO**



E2 Opale - Opal **E19** UGR<19 Prism

B 3000K

C 4000K

BV **NE**

Alimentatore non incluso - Power Supply not included - Netzteil nicht inbegriffen

Esempio - Example - Beispiel *

2240lm con - with - mit **E19** - 2240lm - 15% con - with - mit **E2**



DOWNLIGHT

3037F

50W 4500lm* - 24VDC

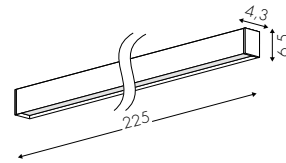

3037G

56W 5060lm - 24VDC

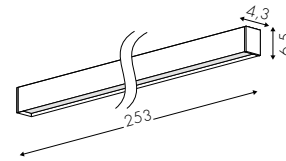

3037H

62W 5620lm - 24VDC

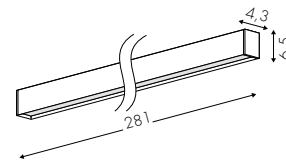

E2 Opale - Opal E19 UGR<19 Prism



B 3000K



C 4000K

BV NE



**ALIMENTATORE
NON INCLUSO**

 Alimentatore non incluso - Power Supply not included - Netzteil nicht inbegriffen

Esempio - Example - Beispiel *

4500lm con - with - mit **E19** - 4500lm - 15% con - with - mit **E2**



3037L

87W 7880lm* - 24VDC

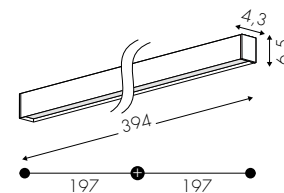

3037M

111W 10120lm - 24VDC

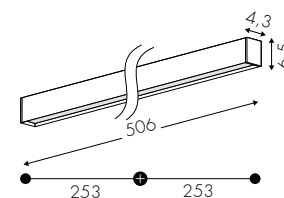

3037N

124W 11240lm - 24VDC

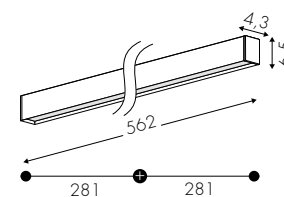

3037O

148,5W 13500lm - 24VDC

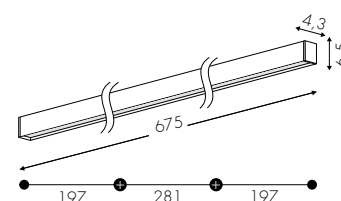

ALIMENTATORE
NON INCLUSO



A E2 Opale - Opal E19 UGR<19 Prism

B 3000K

C 4000K

BV NE



A Alimentatore non incluso - Power Supply not included - Netzteil nicht inbegriffen

Esempio - Example - Beispiel *

7880lm con - with - mit **E19** - 7880lm - 15% con - with - mit **E2**



DOWNLIGHT

3037P

173W 15740lm* - 24VDC

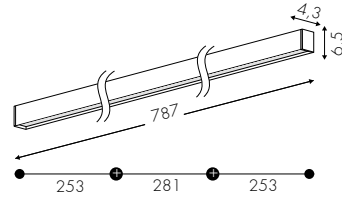

3037Q

185W 16860lm - 24VDC

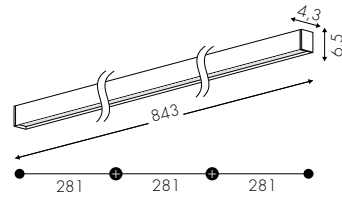

3037R

223W 20240lm - 24VDC

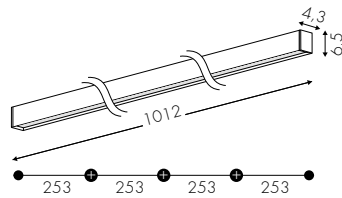

3037KGA

25W 2240lm - 24VDC

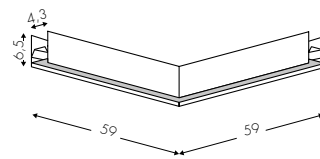

E2 Opale - Opal E19 UGR<19 Prism



B 3000K



C 4000K

BV NE

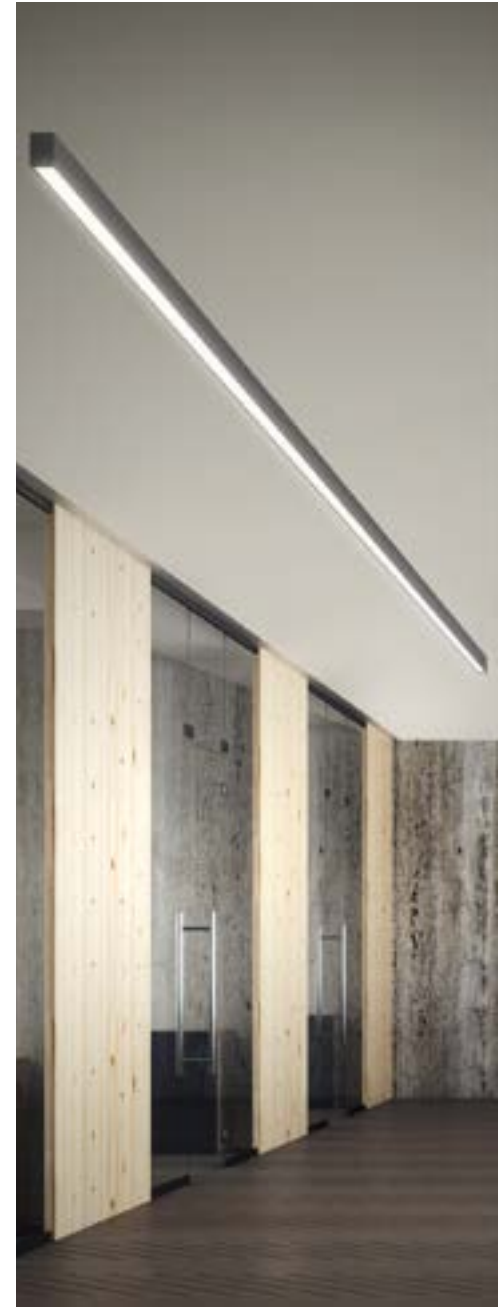

A Alimentatore non incluso - Power Supply not included - Netzteil nicht inbegriffen

Esempio - Example - Beispiel *

15740lm con - with - mit E19 - 15740lm - 15% con - with - mit E2

ALIMENTATORE
NON INCLUSO



EMME 24
POWER UNITS

Scocche dalla linea minimale precablate complete di alimentatori 24VDC e dimmer. I 3 modelli consentono di alimentare fino a 11Mt di sistema EMME24.

Minimal pre-wired boxes equipped with 24VDC power supplies and dimmers. The 3 models can supply up to 11Mt of EMME24 elements.

Minimale verkabelte Gehäuse mit 24VDC Netzteil und Dimmer ausgestattet. Die 3 Versionen ermöglichen eine Versorgung von bis zu 11 Meter EMME24 Elementen.

9037AOF	75W - 220V
9037ADM	DALI (Push) - 75W - 220V
9037ATF	75W - 220V

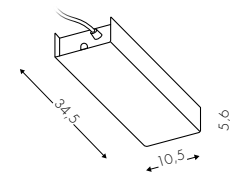

0-3 METRI

9037BOF	150W - 220V
9037BDM	DALI (Push) - 150W - 220V
9037BTF	150W - 220V

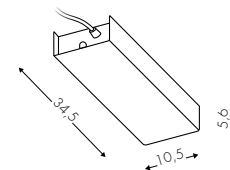

3-6 METRI

9037COF	240W - 220V
9037CDM	DALI (Push) - 240W - 220V

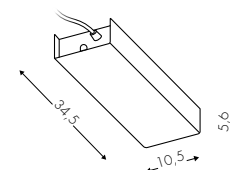

6-11 METRI



ALIMENTAZIONE EMME24 - POWER UNIT FOR EMME24 - NETZTEIL FÜR EMME24

BV NE



TF Taglio di Fase - Phase-Cut Dimmer - Erhältlich Phasenabschrittdimmer
A Alimentatore Incorporato - Incorporated Power Supply - Phasenabschrittdimmer erhältlich







 
MADE in ITALY

Sistema led lineare componibile e versatile. La flessibilità delle proprie caratteristiche strutturali ed illuminotecniche unita al sistema semplificato di codifica per grandi lunghezze rende il sistema Emme24 ad incasso lo strumento d'espressione ideale del professionista per l'illuminazione architettuale.

Versatile modular LED lights system. The flexibility of its structural and lighting technology characteristics, combined with the simplified coding for large lengths, makes Emme24 recessed light a perfect tool for architectural lighting.

Vielseitiges modulares Led-Leuchtersystem. Die Flexibilität der baulichen und lichttechnischen Eigenschaften, kombiniert mit der vereinfachten Kodierung für große Längen, macht die Emme24-Einbauleuchte zu einem perfekten Werkzeug für die Architekturbeleuchtung.



**EMME 24
INCASSO**



EMME24 INCASSO

Moduli ad incasso 24VDC componibili con emissione luminosa diretta disponibile con schermo in PMMA Opale o PC Microprismatizzato.

Recessed direct light modular 24VDC elements available with PMMA opal or PC microprismatic diffuser.

24VDC Einbaumodule mit direkter Lichtausstrahlung: PMMA Opal oder PC microprismatischem Diffusor.

4037A 19W 1680lm* - 24VDC

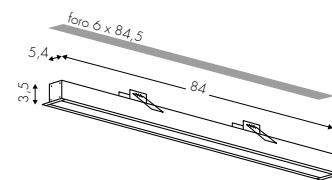

4037B 25W 2240lm - 24VDC

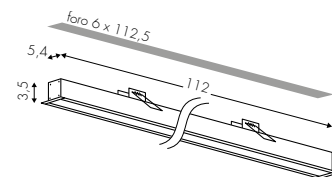

4037C 31W 2800lm - 24VDC

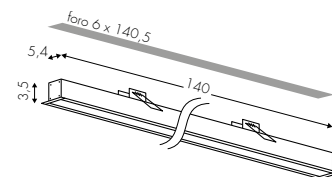

4037D 37W 3360lm - 24VDC

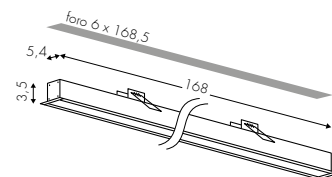

ALIMENTATORE
NON INCLUSO



E2 Opale - Opal E19 UGR<19 Prism



BV NE



Alimentatore non incluso - Power Supply not included - Netzteil nicht inbegriffen
Alimentatori a pag.466-467 - Power Supply p.466-467 - Netzteil p.466-467

Esempio - Example - Beispiel *

1680lm con - with - mit E19 - 1680lm - 1.5% con - with - mit E2



DOWNLIGHT

4037E

44W 3940lm* - 24VDC

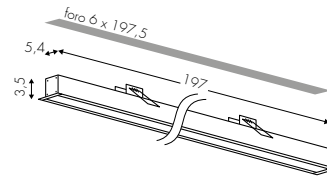

4037F

50W 4500lm - 24VDC

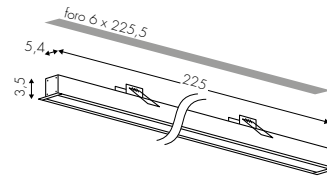

4037G

56W 5060lm - 24VDC

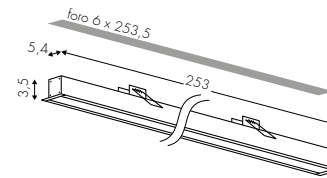

4037H

62W 5620lm - 24VDC

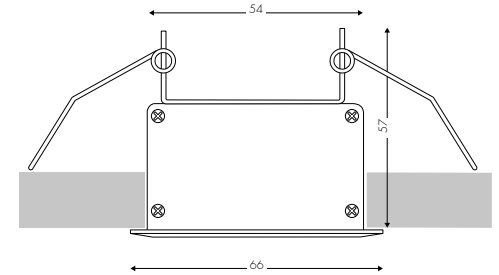
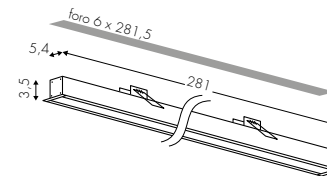

E2 Opale - Opal E19 UGR<19 Prism

● B 3000K

○ C 4000K

BV NE

ALIMENTATORE
NON INCLUSO

A Alimentatore non incluso - Power Supply not included - Netzteil nicht inbegriffen
Alimentatori a pag.466-467 - Power Supply p.466-467 - Netzteil p.466-467

Esempio - Example - Beispiel *

3940lm con - with - mit E19 - 3940lm - 15% con - with - mit E2



indice
fotografico







4037L

87W 7880lm* - 24VDC

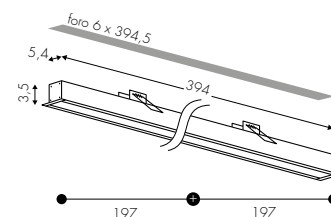

4037M

111W 10120lm - 24VDC

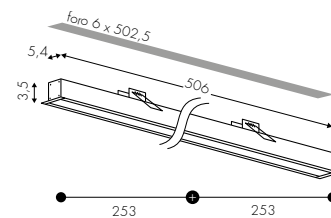

4037N

124W 11240lm - 24VDC

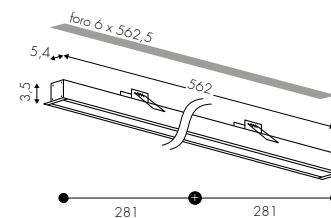

4037O

148,5W 13500lm - 24VDC

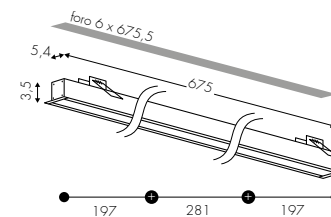

ALIMENTATORE
NON INCLUSO



A E2 Opale - Opal E19 UGR<19 Prism

B 3000K

C 4000K



A Alimentatore non incluso - Power Supply not included - Netzteil nicht inbegriffen
Alimentatori a pag.466-467 - Power Supply p. 466-467 - Netzteil p. 466-467

Esempio - Example - Beispiel *
7880lm con - with - mit **E19** - 7880lm - 15% con - with - mit **E2**



DOWNLIGHT

4037P

173W 15740lm* - 24VDC

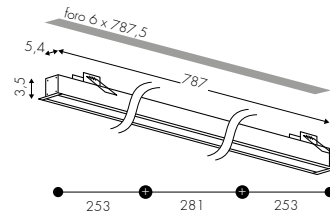

4037Q

185W 16860lm - 24VDC

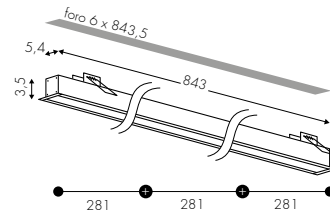

4037R

223W 20240lm - 24VDC

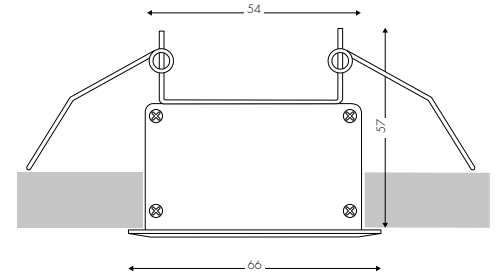
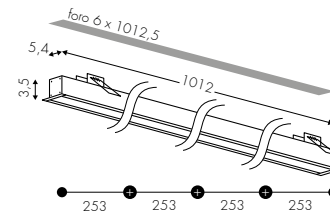

E2 Opale - Opal E19 UGR<19 Prism



B 3000K



C 4000K

BV NE



ALIMENTATORE
NON INCLUSO

A Alimentatore non incluso - Power Supply not included - Netzteil nicht inbegriffen
Alimentatori a pag. 466-467 - Power Supply p. 466-467 - Netzteil p. 466-467

Esempio - Example - Beispiel *

15740lm con - with - mit **E19** - 15740lm - 15% c on - with - mit **E2**



4037KGA

25W 2240lm* - 24VDC

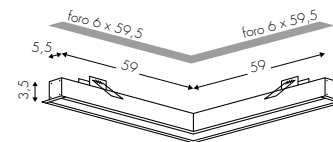

4037KGT

19W 1680lm - 24VDC

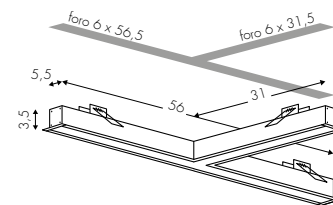

4037KGV

25W 2240lm - 24VDC

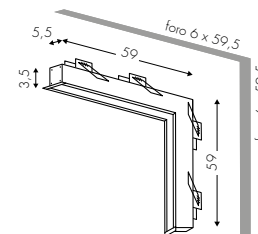

ALIMENTATORE
NON INCLUSO



E2 Opale - Opal E19 UGR<19 Prism

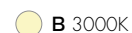

BV NE



A Alimentatore non incluso - Power Supply not included - Netzteil nicht inbegriffen
Alimentatori a pag.466-467 - Power Supply p. 466-467 - Netzteil p. 466-467

Esempio - Example - Beispiel *

2240lm con - with - mit **E19** - 2240lm - 1.5% con - with - mit **E2**







 
MADE in ITALY

Essenzialità, design, semplicità di installazione, sono i segni distintivi di questa famiglia di prodotti. Minisimply risulta essere una soluzione tecnica ideale per l'ambiente lavorativo, espositivo e domestico.

Simplicity, design and ease of installation are the hallmarks of this family of products. Minisimply is a technical solution for working spaces, exhibition galleries, stores and domestic environments.

Wesentlichkeit, Design, einfache Montage, sind die Unterscheidungsmerkmale dieser Lampen Familie. Minisimply erweist sich als ideale technische Lösung für die Geschäfts-, Ausstellungs- und Hausräume.



MINISIMPLY



MINISIMPLY READY

Lampada led lineare a sospensione con diffusore prismaticizzato per il controllo dell'abbagliamento luminoso od opalino. Emissione up-down. Alimentatore integrato.

Linear pendant led lamp with prismatic (to control the glare) or polycarbonate opal diffuser. Up-down light emission. Integrated power supply.

Lineare Led-Pendelleuchte mit prismatisiertem Diffusor als Blendschutz Kontrolle oder Opaldiffusor. Up-Down Lichtemission. Mit integriertem Netzteil.



1022AOF
1022ADM
1022AOFEM

29W 3000lm* + 8W 900lm - 220V
DALI (Push) - 29W 3000lm + 8W 900lm - 220V
29W 3000lm + 8W 900lm - 220V

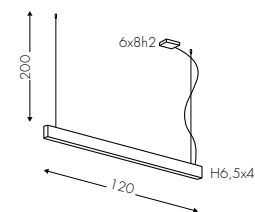

1022BOF
1022BDM
1022BOFEM

37W 3900lm + 8W 900lm - 220V
DALI (Push) - 37W 3900lm + 8W 900lm - 220V
37W 3900lm + 8W 900lm - 220V

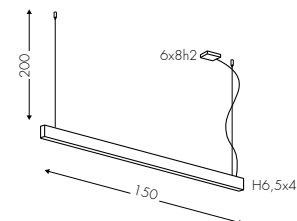

1022COF
1022CDM
1022COFEM

58W 6025lm + 22W 2475lm - 220V
DALI (Push) - 58W 6025lm + 22W 2475lm - 220V
58W 6025lm + 22W 2475lm - 220V

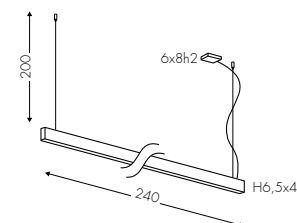

BV NE
CUSTOM



E2 Opale - Opal
E19 UGR<19 Prism

A 2700K

B 3000K

C 4000K

RV BR OS

EM Emergenza - Emergency - Notbeleuchtung

A Alimentatore Incorporato - Incorporated Power Supply - Eingebautes Netzteil

Esempio - Example - Beispiel *

3000lm con - with - mit **E19** - 3000lm - 1.5% con - with - mit **E2**







MINISIMPLY INCASSO

Lampada ad incasso con cornice per cartongesso con sorgente luminosa a led 24VDC. Emissione down. Alimentatore non incluso.

Recessed lamp with frame for plasterboard with 24VDC led Source. Down light emission. Not included power supply.

Einbauleuchte für Gipskartonwände mit Rahmen, 24VDC Led Lichtquelle und Down Lichtemission. Das Netzteil ist nicht enthalten.

4022T

7W 560lm* - 24VDC

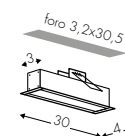

4022U

13W 1120lm - 24VDC

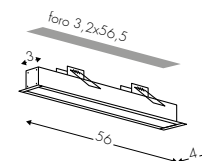

4022B

25W 2240lm - 24VDC

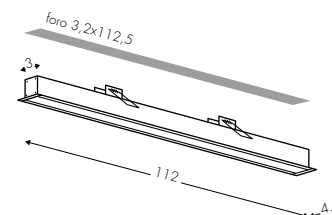
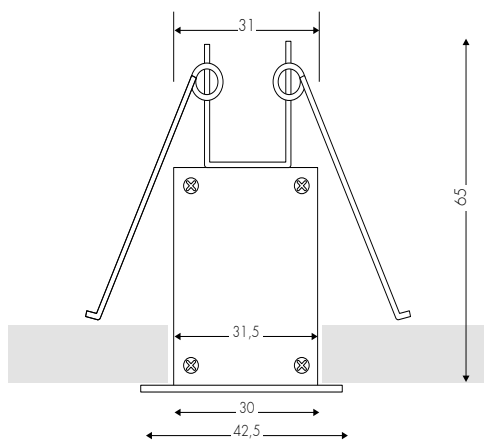

**ALIMENTATORE
NON INCLUSO**



E2 Opale - Opal
E19 UGR<19 Prism

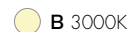
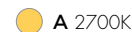

BV NE



A Alimentatore non incluso - Power Supply not included - Netzteil nicht enthalten
Alimentatori a pag.466-467 - Power Supply p.466-467 - Netzteil p.466-467

Esempio - Example - Beispiel *

560lm con - with - mit **E19** - 560lm - 15% con - with - mit **E2**







4022C

31W 2800lm* - 24VDC

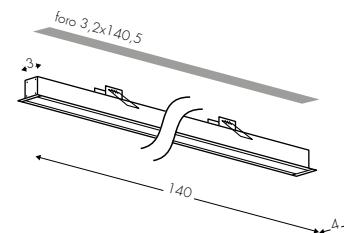

4022F

50W 4500lm - 24VDC

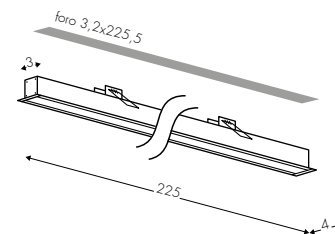

E2 Opale - Opal
E19 UGR<19 Prism

● A 2700K

● B 3000K

○ C 4000K

BV NE



A Alimentatore non incluso - Power Supply not included - Netzteil nicht enthalten
Alimentatori a pag.466-467 - Power Supply p.466-467 - Netzteil p.466-467

Esempio - Example - Beispiel *

2800lm con - with - mit **E19** - 2800lm - 1.5% con - with - mit **E2**







4022KGA

25W 2240lm* - 24VDC

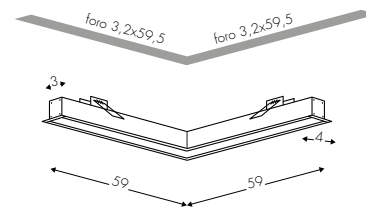

4022KGV

25W 2240lm - 24VDC

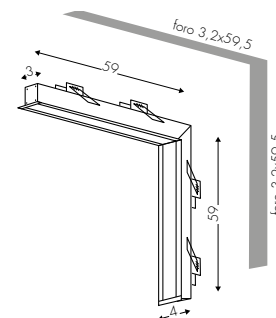

E2 Opale - Opal
E19 UGR<19 Prism



A 2700K



B 3000K



C 4000K

BV NE



A Alimentatore non incluso - Power Supply not included - Netzteil nicht enthalten
Alimentatori a pag.466-467 - Power Supply p.466-467 - Netzteil p.466-467

Esempio - Example - Beispiel *

2240lm con - with - mit **E19** - 2240lm - 15% con - with - mit **E2**







 
MADE in ITALY

254

La ricerca della massima efficienza luminosa e la semplicità estetica caratterizzano M-Eco, una famiglia di prodotti ideale per l'illuminazione degli ambienti di lavoro.

The quest for maximum luminous efficiency and aesthetic simplicity characterise M-eco, a product family ideal for workplace lighting.

Die Suche nach maximaler Beleuchtungseffizienz und ästhetischer Schlichtheit kennzeichnen M-eco, eine Produktfamilie, die ideal für die Beleuchtung von Arbeitsumgebungen ist.



M-ECO





M - ECO

Lampada led lineare a sospensione con diffusore prismaticizzato per il controllo dell'abbagliamento luminoso o opalino. Emissione up-down. Alimentatore integrato.

Linear pendant led lamp with prismatic (to control the glare) or polycarbonate opal diffuser. Up-down emission. Integrated power supply.

Lineare Led-Pendelleuchte mit prismaticiertem Diffusor als Blendschutz Kontrolle oder Opaldiffusor. Up-Down Lichtemission. Mit integriertem Netzteil.



1058BOF
1058BDM
1058BOFEM

18W 2380lm* + 8W 1100lm - 220V
DALI (Push) - 18W 2380lm + 8W 1100lm - 220V
18W 2380lm + 8W 1100lm - 220V

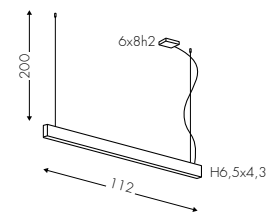

1058COF
1058CDM
1058COFEM

22W 2975lm + 8W 1100lm - 220V
DALI (Push) - 22W 2975lm + 8W 1100lm - 220V
22W 2975lm + 8W 1100lm - 220V

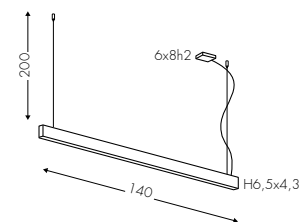

1058EOF
1058EDM
1058EOFEM

31W 4165lm + 16W 2200lm - 220V
DALI (Push) - 31W 4165lm + 16W 2200lm - 220V
31W 4165lm + 16W 2200lm - 220V

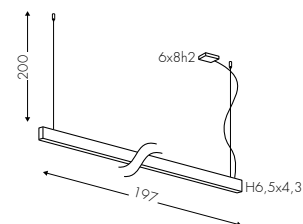

1058GOF
1058GDM
1058GOFEM

39W 5300lm + 16W 2200lm - 220V
DALI (Push) - 39W 5300lm + 16W 2200lm - 220V
39W 5300lm + 16W 2200lm - 220V

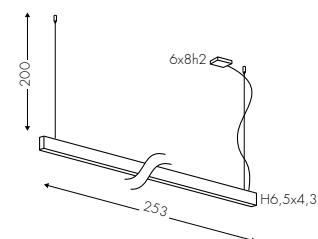

A E2 Opale - Opal
E19 UGR<19 Prism

● A 2700K ● B 3000K ○ C 4000K

BV NE RU
□ □ □

EM Emergenza - Emergency - Notbeleuchtung

A Alimentatore Incorporato - Incorporated Power Supply - Eingebautes Netzteil

Esempio - Example - Beispiel *

2380lm con - with - mit **E19** - 2380lm - 1.5% con - with - mit **E2**







M - ECO

Lampada led lineare a plafone con diffusore prismatico per il controllo dell'abbagliamento luminoso o opalino. Emissione down. Alimentatore integrato.

Linear ceiling led lamp with prismatic (to control the glare) or polycarbonate opal diffuser. Down emission. Integrated power supply.

Lineare led-Deckenlampe mit prismaticiertem Diffusor als Blendschutz Kontrolle oder Opaldiffusor. Down Lichtemission. Mit integriertem Netzteil.

3058TOF 7,5W 1000lm* - 220V

3058TTF 7,5W 1000lm - 220V

3058UOF 9W 1190lm - 220V

3058UTF 9W 1190lm - 220V

3058BOF 18W 2380lm - 220V

3058BDM DALI (Push) - 18W 2380lm - 220V

3058BOFEM 18W 2380lm - 220V

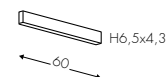
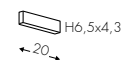

E2 Opale - Opal
E19 UGR<19 Prism



A 2700K

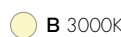

B 3000K



C 4000K



EM Emergenza - Emergency - Notbeleuchtung

TF Taglio di Fase - Phase-Cut Dimmer - Erhältlich Phasenabschnittdimmer

A Alimentatore Incorporato - Incorporated Power Supply - Eingebautes Netzteil

Esempio - Example - Beispiel *

1000lm con - with - mit **E19** - 1000lm - 1.5% con - with - mit **E2**





3058T



3058COF 22W 2975lm* - 220V
3058CDM DALI (Push) - 22W 2975lm - 220V
3058COFEM 22W 2975lm - 220V

3058EOF 31W 4165lm - 220V
3058EDM DALI (Push) - 31W 4165lm - 220V
3058EOFEM 31W 4165lm - 220V

3058GOF 39W 5300lm - 220V
3058GDM DALI (Push) - 39W 5300lm - 220V
3058GOFEM 39W 5300lm - 220V

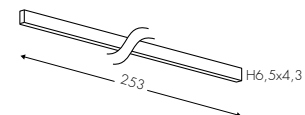
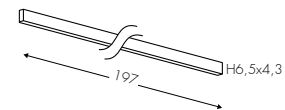
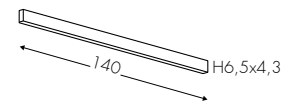

E2 Opale - Opal
E19 UGR<19 Prism



A 2700K



B 3000K



C 4000K



EM Emergenza - Emergency - Notbeleuchtung

A Alimentatore Incorporato - Incorporated Power Supply - Eingebautes Netzteil

Esempio - Example - Beispiel *

2975lm con - with - mit **E19** - 2975lm - 1.5% con - with - mit **E2**







M - ECO TRACK

Lampada Led lineare predisposta per binario elettrificato. Diffusore prismaticizzato per il controllo dell'abbagliamento luminoso. Emissione down. Alimentatore integrato.

Linear Led electrified track. Equipped with a prismatic diffuser to control the glare. Down-light emission and integrated power supply.

Lineare Led Leuchte geeignet für Stromschienen. Mit prismaticisiertem Diffusor als Blendschutzkontrolle ausgestattet. Down-Lichtemission und integriertem Netzteil.



T058UOF 9W 1190lm* - 220V

T058BOF 18W 2380lm - 220V

T058BDM DALI (Push) - 18W 2380lm - 220V

T058BOFEM 18W 2380lm - 220V

T058COF 22W 2975lm - 220V

T058CDM DALI (Push) - 22W 2975lm - 220V

T058COFEM 22W 2975lm - 220V

T058GOF 39W 5300lm - 220V

T058GDM DALI (Push) - 39W 5300lm - 220V

T058GOFEM 39W 5300lm - 220V

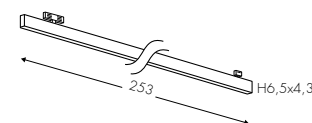
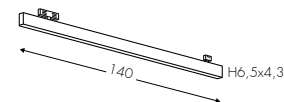
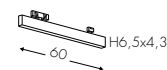

E2 Opale - Opal
E19 UGR<19 Prism



A 2700K



B 3000K



C 4000K



EM Emergenza - Emergency - Notbeleuchtung

A Alimentatore Incorporato - Incorporated Power Supply - Eingebautes Netzteil

Esempio - Example - Beispiel *

1 190lm con - with - mit **E19** - 1190lm - 15% con - with - mit **E2**







T058BSOF
T058BSDM

18W 2380lm* - 220V
DALI (Push) - 18W 2380lm - 220V

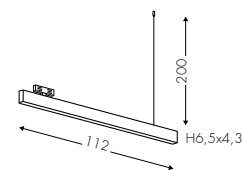

T058CSOF
T058CSDM

22W 2975lm - 220V
DALI (Push) - 22W 2975lm - 220V

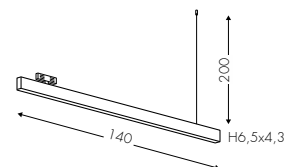

T058HSOF
T058HSDM

39W 5300lm - 220V
DALI (Push) - 39W 5300lm - 220V

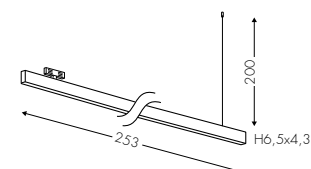

E2 Opale - Opal
E19 UGR<19 Prism

● **A** 2700K

● **B** 3000K

○ **C** 4000K

BV **NE** **RU**
□ □ □



Alimentatore Incorporato - Incorporated Power Supply - Eingebautes Netzteil







 
MADE in ITALY

266

Collezione di apparecchi dalla forma geometrica semplice e regolare. Emissione luminosa potente, diffusa con diffusore opale ideale in ambito residenziale o con limitazione dell'abbagliamento microprism per l'illuminazione degli ambienti di lavoro.

Collection of lamps with a simple and regular geometric shape. The powerful light emission is diffused with an opal diffuser for residential use. The micro-prismatic diffuser is ideal in working environments where glare reduction is needed.

Kollektion von Lampen mit einer einfachen und regelmäßigen geometrischen Form. Die starke Lichtabstrahlung wird mit einem Opaldiffusor für den Wohnbereich gestreut. Der mikroprismatische Diffusor ist ideal für Arbeitsumgebungen, in denen eine Blendungsbegrenzung erforderlich ist.





EDGE



EDGE

Lampada a sospensione dalla forma semplice e regolare, quadrata o rettangolare, con emissione luminosa downlight diffusa con diffusore opale o con limitazione dell'abbagliamento con microprism.

Alimentatore incluso nel rosone.

Suspension lamp with a simple and regular shape. Square or rectangular, made with a downlight emission filtered by a opal diffuser or micro-prismatic diffusor to limit the bright glare. Power supply included in ceiling rose.

Pendelleuchte mit einfacher und gleichmäßiger Form. Eine quadratische oder rechteckige Leuchte, mit einer Down Lichtemission, die durch einen opalen Diffusor oder einen Mikro-prismatischen Diffusor gefiltert wird, um die Blendung zu reduzieren. Das Netzteil ist in der Rosette enthalten.

1028BOF
1028BDM

50W 4290lm* - 220V
DALI (Push) - 50W 4290lm - 220V

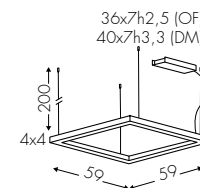

1028COF
1028CDM

75W 6435lm - 220V
DALI (Push) - 75W 6435lm - 220V

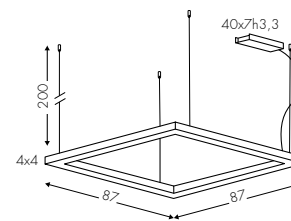

1028DOF
1028DDM

100W 8580lm - 220V
DALI (Push) - 100W 8580lm - 220V

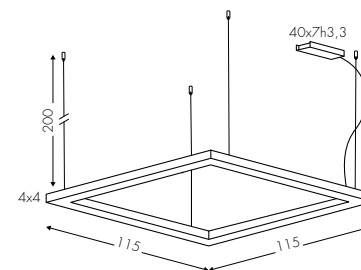

A E2 Opale - Opal
E19 UGR<19 Prism



A 2700K



B 3000K



C 4000K



A Alimentatore nel rosone - Power Supply inside the ceiling rose - Netzteil in der Deckendose

Esempio - Example - Beispiel *

4290lm con - with - mit **E19** - 4290lm -15% con - with - mit **E2**







1028EOF
1028EDM

62W 5363lm* - 220V
DALI (Push) - 62W 5363lm - 220V

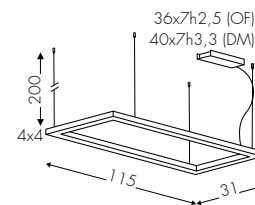

1028HOF
1028HDM

88W 7550lm - 220V
DALI (push) - 88W 7550lm - 220V

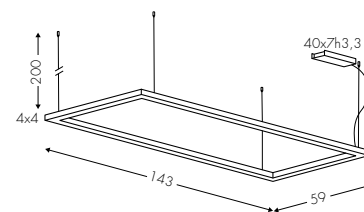

1028GOF
1028GDM

138W 11780lm - 220V
DALI (Push) - 138W 11780lm - 220V

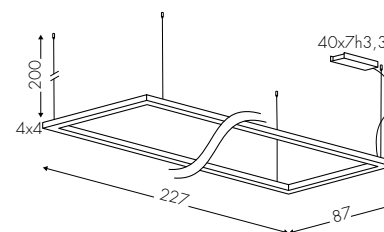

A E2 Opale - Opal
E19 UGR<19 Prism



A 2700K



B 3000K



C 4000K



A Alimentatore nel rosone - Power Supply inside the ceiling rose - Netzteil in der Deckendose

Esempio - Example - Beispiel *

5363lm con - with - mit **E19** - 5363lm -15% con - with - mit **E2**







EDGE

Lampada a sospensione dalla forma semplice e regolare, quadrata o rettangolare, con emissione luminosa indiretta upright diffusa. Alimentatore incluso nel rosone.

Suspension lamp with a simple and regular shape. Square or rectangular, made with indirect upright emission. Power supply included in ceiling rose.

Pendelleuchte mit einfacher und gleichmäßiger Form. Eine quadratische oder rechteckige Leuchte, mit einer Up Lichtemission. Das Netzteil ist in der Rosette enthalten.



1028BUPOF

50W 4290lm* - 220V

1028BUPDM

DALI (Push) - 50W 4290lm - 220V

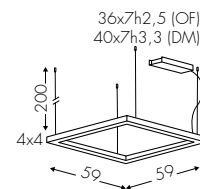

1028CUPOF

75W 6435lm - 220V

1028CUPDM

DALI (Push) - 75W 6435lm - 220V

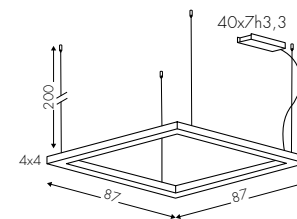

1028HUPOF

88W 7550lm - 220V

1028HUPDM

DALI (push) - 88W 7550lm - 220V

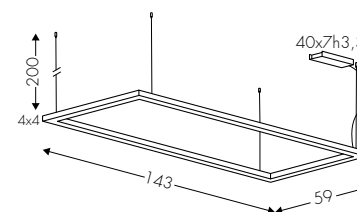

E28 Satinato
Frosted - Satiniert



A 2700K



B 3000K



C 4000K



A Alimentatore nel rosone - Power Supply inside the ceiling rose - Netzteil in der Deckendose







EDGE

Lampada led lineare a sospensione con diffusore prismaticizzato per il controllo dell'abbagliamento luminoso o opalino. Emissione downlight. Alimentatore incluso nel rosone.

Linear pendant led lamp with prismatic (to control the glare) or opal diffuser. Downlight emission. The power supply is included in ceiling rose.

Lineare Led Pendelleuchte mit prismatischem Diffusor als Blendschutz Kontrolle oder Opaldiffusor. Down Lichtemission. Das Netzteil ist in der Rosette enthalten.

1028SOF 25W 2600lm* - 220V
1028SDM DALI (Push) - 25W 2600lm - 220V
1028STF 25W 2600lm - 220V

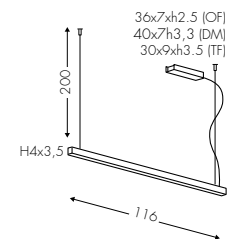

1028TOF 31W 3280lm - 220V
1028TDM DALI (Push) - 31W 3280lm - 220V
1028TTF 31W 3280lm - 220V

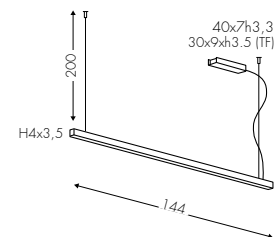

1028UOF 52W 5510lm - 220V
1028UDM DALI (Push) - 52W 5510lm - 220V

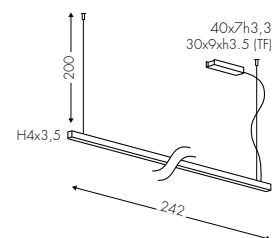

1028VOF 62W 6570lm - 220V
1028VDM DALI (Push) - 62W 6570lm - 220V

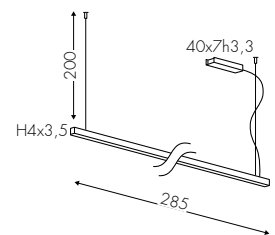

A E2 Opale - Opal
 E19 UGR<19 Prism



A 2700K **B** 3000K **C** 4000K



TF Taglio di Fase - Phase-Cut Dimmer - Erhältlich Phasenabschnittdimmer

A Alimentatore nel rosone - Power Supply inside the ceiling rose - Netzteil in der Deckendose

Esempio - Example - Beispiel *

2600lm con - with - mit **E19** - 2600lm -1.5% con - with - mit **E2**







EDGE

Lampada da terra ideale per installazione in ambienti di lavoro (uffici). Emissione luminosa downlight o con microprism per il controllo dell'abbagliamento. Alimentatore incorporato, possibilità di regolazione dell'intensità con pulsante.

Floor lamp ideal for office application. Downlight Emission with micro-prismatic diffusor to reduce the glare. The power supply is integrated. Adjustable light intensity with the button.

Stehleuchte ideal für Büroanwendungen. Down Light mit prismatischem Diffusor für Blendung Kontrolle. Mit integriertem Netzteil und einstellbarer Lichtintensität mit der Taste.

5028BDM

DIM (Push) - 51W 4400lm* - 220V

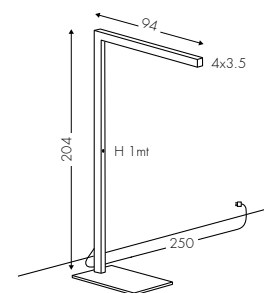
**A** E19 UGR<19 Prism

● A 2700K

● B 3000K

○ C 4000K



Alimentatore Incorporato - Incorporated Power Supply - Eingebautes Netzteil



DIM (Push)





 
MADE in ITALY

278

Forme morbidamente geometriche ed eccezionali prestazioni illuminotecniche, date dalle più efficienti sorgenti led, fanno di «Shape» una linea di elementi luminosi che disegnano finemente l'ambiente illuminandolo in modo efficace.

The soft geometrical shapes and the exceptional lighting performance, given by the most efficient led sources, make «Shape» a line of luminous elements that finely design the environment and illuminate it effectively.

Weiche geometrische Formen und außerordentliche beleuchtungstechnische Leistungen, erhalten durch die effizientesten Led-Quellen: das ist "Shape", eine Linie leuchtender Elemente, die die Umgebung gut und effektiv beleuchten.





SHAPE





SHAPE

Sospensione sagomata per utilizzo in ambito retail, ristorazione, grandi spazi, sale riunioni. La forma attentamente plasmata rende il prodotto ideale anche per ambienti domestici. Sorgente led, emissione diretta ed indiretta diffusa. Alimentatore incorporato on-off o dimmerabile. Struttura in alluminio verniciato.

Suspension lamp for the use in retail, restaurants, large spaces, meeting rooms. The carefully shaped line makes the product ideal also for residential environments. Led light-source, direct and indirect emission. On-off or dimmable incorporated power supply. Aluminium painted body.

Pendelleuchte ideal für die Anwendung im Einzelhandel, Restaurants, großen Gemeinschafts- oder Konferenzraum. Durch die sorgfältig modellierte Form, ist das Produkt auch für den Haushalten ideal. Led Licht-Quelle, diffuse direkte und indirekte Ausstrahlung. On-Off oder dimmbar eingebautes Netzteil. Struktur aus lackiertem Aluminium.



1031AOF
1031ADM

52W 5300lm* + 18W 2200lm - 220V
DALI (Push) - 52W 5300lm + 18W 2200lm - 220V

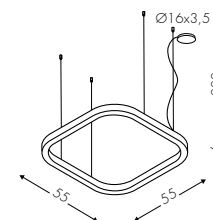

1031BOF
1031BDM

83W 8000lm + 20W 2300lm - 220V
DALI (Push) - 83W 8000lm + 20W 2300lm - 220V

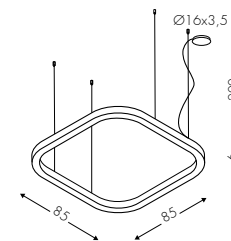

1031COF
1031CDM

114W 10900lm + 30W 3861lm - 220V
DALI (Push) - 114W 10900lm + 30W 3861lm - 220V

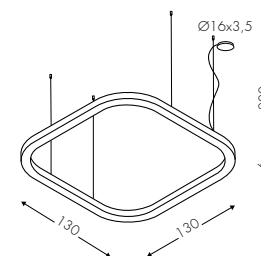

A E2 Opale - Opal
E19 UGR<19 Prism

● A 2700K

● B 3000K

○ C 4000K

BV NE RU

A Alimentatore Incorporato - Incorporated Power Supply - Eingebautes Netzteil

Esempio - Example - Beispiel *
5300lm con - with - mit E19 - 5300lm - 15% con - with - mit E2







1031DOF
1031DDM

105W 11500lm* + 25W 3100lm - 220V
DALI (Push) 105W 11500lm* + 25W 3100lm - 220V

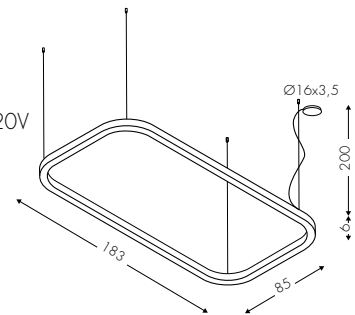

BR
CUSTOM



A E2 Opale - Opal
E19 UGR<19 Prism

A 2700K

B 3000K

C 4000K

BV

NE RU

A Alimentatore Incorporato - Incorporated Power Supply - Eingebautes Netzteil

Esempio - Example - Beispiel *

11500lm con - with - mit **E19** - 11500lm - 15% con - with - mit **E2**







SHAPE

Versione da plafone dotata di cover centrale per consentire il decentramento del punto di alimentazione. Alimentatore On-Off o dimmerabile integrato nel corpo lampada.

Ceiling version with central cover to allow decentralization of the power supply point. On-off and dimmable power supply integrated into the body lamp.

Deckenversion mit zentraler Abdeckung, welche die Dezentralisierung des Netzpunktes ermöglicht. On-off oder dimmbares Netzteil, innerhalb dem Leuchtenkörper verlegt.

**3031AOF**

52W 5300lm* - 220V

3031ADM

DALI (Push) - 52W 5300lm - 220V

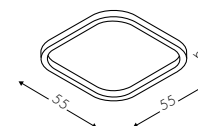
**3031BOF**

83W 8000lm - 220V

3031BDM

DALI (Push) - 83W 8000lm - 220V

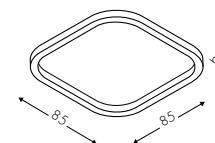

E2 Opale - Opal
E19 UGR<19 Prism

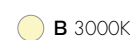
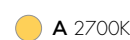

BV NE RU



Alimentatore Incorporato - Incorporated Power Supply - Eingebautes Netzteil

Esempio - Example - Beispiel *

5300lm con - with - mit **E19** - 5300lm - 1.5% con - with - mit **E2**







 
MADE in ITALY

Una linea di compasso che riempie con sobrietà lo spazio architettonico. Forme circolari di grandi dimensioni, dotate di sorgenti luminose a led, garanzia di massima efficienza luminosa e dimensioni contenute, per valorizzare lo spazio visivo senza invaderlo.

The line of a compass that fills the space with refinement. Large circular shapes, equipped with led light sources, that guarantee the maximum luminous efficiency in a slim body, enhancing the visual space without invading it.

Eine Zirkel Linie, die mit Schlichtheit den architektonischen Raum füllt. Große Kreisformen, mit led Lichtquellen ausgestattet, Maximale Lichtausbeute auf beschränkter Ausmaßen, um den visuellen Raum zu verwerten, ohne ihn zu besetzen.



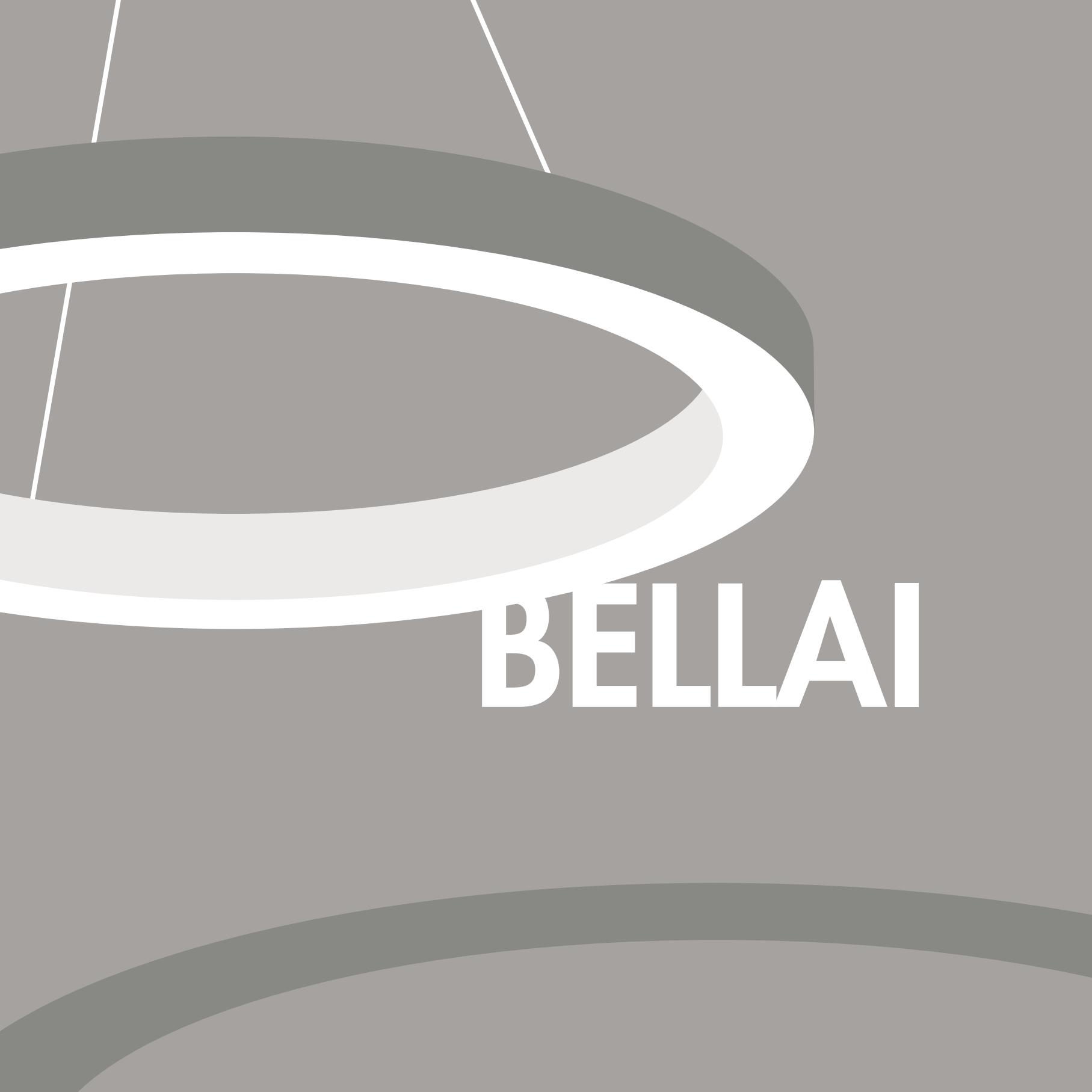

BELLAI



BELLAI

Apparecchio a sospensione circolare con sorgente arretrata a led e diffusore prismaticizzato per il controllo dell'abbagliamento luminoso o opalino in PMMA.
Alimentatore integrato.

Circular pendant light with led source and prismatic diffuser to control the bright glare or with opal PMMA diffuser.
Integrated power supply.

Kreis-Pendelleuchte mit Led-Lichtquelle und prismatisiertem Diffusor als Blendschutz Kontrolle oder PMMA Opal diffusor ausgestattet.
Mit integriertem Netzteil.



1025AOF
1025ADM
1025AOFEM

50W 4480lm* + 14W 2400lm - 220V
DALI (Push) - 50W 4480lm + 14W 2400lm - 220V
50W 4480lm + 14W 2400lm - 220V

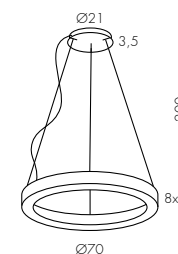

1025BOF
1025BDM
1025BOFEM

65W 6080lm + 14W 2400lm - 220V
DALI (Push) - 65W 6080lm + 14W 2400lm - 220V
65W 6080lm + 14W 2400lm - 220V

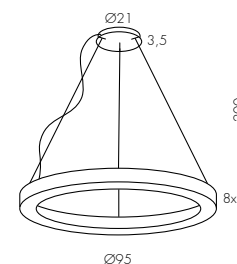

1025COF
1025CDM
1025CBT
1025COFEM

92W 8650lm + 24W 3600lm - 220V
DALI (Push) - 92W 8650lm + 24W 3600lm - 220V
92W 8650lm + 24W 3600lm - 220V
92W 8650lm + 24W 3600lm - 220V

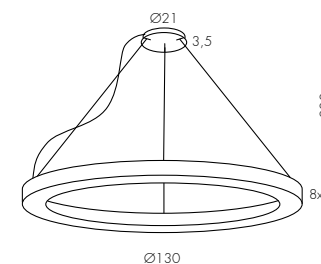

E2 Opale - Opal
E19 UGR<19 Prism



BV **NE** **RU** **SO**



EM Emergenza - Emergency - Notbeleuchtung

BT Bluetooth - Bluetooth - Bluetooth

A Alimentatore Incorporato - Incorporated Power Supply - Eingebautes Netzteil

Esempio - Example - Beispiel *

4480lm con - with - mit **E19** - 4480lm - 15% con - with - mit **E2**







1025DOF
1025DDM
1025DOFEM

160W 15200lm* + 52W 7200lm - 220V
 DALI (Push) - 160W 15200lm + 52W 7200lm - 220V
 160W 15200lm + 52W 7200lm - 220V

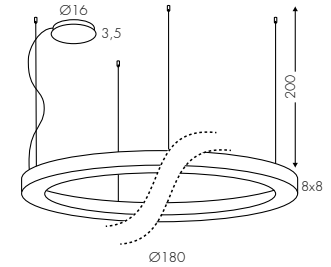

1025EOF
1025EDM
1025EOFEM

250W 24000lm + 70W 9600lm - 220V
 DALI (Push) - 250W 24000lm + 70W 9600lm - 220V
 250W 24000lm + 70W 9600lm - 220V

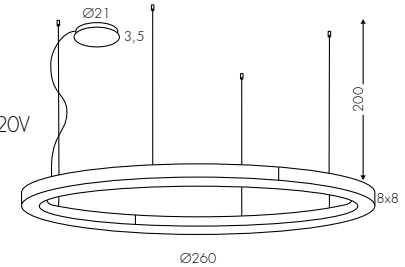

EM Emergenza - Emergency - Notbeleuchtung
A Alimentatore Incorporato - Incorporated Power Supply - Eingebautes Netzteil

Esempio - Example - Beispiel*
 15200lm con - with - mit **E19** - 15200lm - 15% con - with - mit **E2**





**BELLAI**

Apparecchio a plafone circolare con sorgente luminosa a led. Diffusore arretrato prismaticizzato per il controllo dell'abbagliamento luminoso o opalino in PMMA. Alimentatore integrato.

Circular ceiling lamp with led light source. Set back prismatic diffuser to control the bright glare or with opal PMMA diffuser. Integrated power supply.

Kreis-Deckenleuchte mit Led Lichtquelle und zurückgesetztem prismaticem Diffusor als Blendschutz Kontrolle oder PMMA Opaldiffusor ausgestattet. Mit integriertem Netzteil.

3025AOF 50W 4480lm* - 220V
3025ADM DALI (Push) - 50W 4480lm - 220V
3025AOFEM 50W 4480lm - 220V

3025BOF 65W 6080lm - 220V
3025BDM DALI (Push) - 65W 6080lm - 220V
3025BOFEM 65W 6080lm - 220V

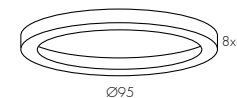
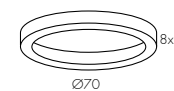

E2 Opale - Opal
E19 UGR<19 Prism



A 2700K



B 3000K



C 4000K

BV **NE** **RU** **SO**



EM Emergenza - Emergency - Notbeleuchtung

A Alimentatore Incorporato - Incorporated Power Supply - Eingebautes Netzteil

Esempio - Example - Beispiel *

4480lm con - with - mit **E19** - 4480lm - 1.5% con - with - mit **E2**







3025COF 92W 8650lm* - 220V
3025CDM DALI (Push) - 92W 8650lm - 220V
3025COFEM 92W 8650lm - 220V

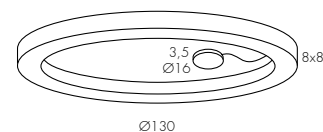

3025DOF 160W 15200lm - 220V
3025DDM DALI (Push) - 160W 15200lm - 220V
3025DOFEM 160W 15200lm - 220V

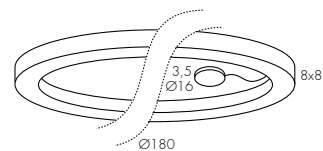

E2 Opale - Opal
E19 UGR<19 Prism



A 2700K



B 3000K



C 4000K

BV

NE

RU

SO



EM Emergenza - Emergency - Notbeleuchtung

A Alimentatore Incorporato - Incorporated Power Supply - Eingebautes Netzteil

Esempio - Example - Beispiel *

8650lm con - with - mit **E19** - 8650lm - 1.5% con - with - mit **E2**





Applicazione a parete
Wall application
Wandanwendung



 
MADE in ITALY

296

La forma semplice ed armoniosa di Bellai UP nasconde un potente motore luminoso che consente di illuminare indirettamente l'ambiente in modo efficace ma non invasivo.

The simple and harmonious form of Bellai UP hides a powerful light engine that allows to indirectly light up the areas with effective but not invasive way.

Die einfache und harmonische Form von Bellai UP verbergt einen leistungsstarken Lichtstrom welcher die Umgebung indirekt beleuchtet, auf wirkungsvoller aber nicht invasiver Art und Weise.





**BELLAI
UP**

**BELLAI UP**

Apparecchio a sospensione a luce indiretta con alimentatore incluso nel rosone.
Disponibile in due diametri e in numerose finiture adatte ad ogni ambiente.

Suspension lamp with indirect light and the power supply included in the ceiling rose.
Available in two diameters and a lot of finishes suitable for every environment.

Pendelleuchte mit indirektem Licht und das Netzteil innerhalb der Rosette verlegt.
In zwei Durchmesser und verschiedenen Feinbearbeitungen verfügbar, die für jede Umgebung geeignet sind.



1040COF
1040CDM

115W 13000lm* - 220V
DALI (Push) - 115W 13000lm - 220V

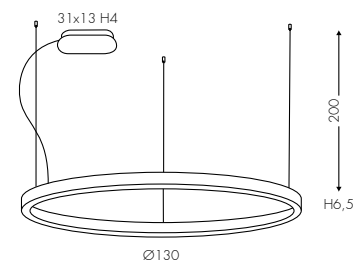

1040DOF
1040DDM

145W 16000lm - 220V
DALI (Push) - 145W 16000lm - 220V

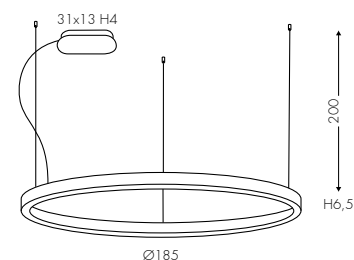

A E28 Satinato
Frosted - Satiniert



A 2700K **B** 3000K **C** 4000K

BV **NE** **RU** **SO**



A Alimentatore nel rosone - Power Supply inside the ceiling rose - Netzteil in der Deckendose

Esempio - Example - Beispiel *
13000lm con - with - mit **E28**







 
MADE in ITALY

300

Dimensioni ridotte e prestazioni eccezionali sono le caratteristiche di questa lampada da parete caratterizzata da un design essenziale. Una lente speciale in policarbonato regola l'abbagliamento rendendo Simply la soluzione ideale per uffici, negozi, spazi museali e di culto.

Slim size and outstanding performance are the hallmarks of this wall lamp characterized by an essential design. A special polycarbonate lens regulates the glare making Simply the ideal solution for offices, shops, museum and worship spaces.

Reduzierte Ausmaßen und außerordentliche Leistungen sind die Eigenschaften dieser minimalen Design-Wandleuchte. Eine spezielle Polycarbonat-Linse reguliert den Blendschutz, somit ist Simply die ideale Lösung für Büros, Geschäfte, Museums- und Anbetungsräume.





SIMPLY



SIMPLY

Versione da parete biemissione con sorgente luminosa a led caratterizzata da prestazioni elevate grazie a una lente speciale in policarbonato che minimizza l'abbagliamento garantendo la massima efficienza.

Double emission wall lamp with led light source characterized a by slim body and outstanding performance thanks to an innovative polycarbonate lens that minimizes the glare for a maximum light output.

Doppel Emission Wandleuchte mit Led-Lichtquelle bietet hohe Leistungen, dank der speziellen Polycarbonat-Linse, die die Blendung reduziert und eine maximale Leuchtwiedergabe versichert.



2019AOF

21W 2700lm* - 220V

2019ADM

DALI (Push) - 21W 2700lm - 220V

2019ATF

21W 2700lm - 220V

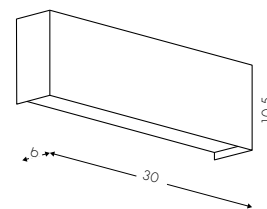

2019BOF

42W 5300lm - 220V

2019BDM

DALI (Push) - 42W 5300lm - 220V

2019BTF

42W 5300lm - 220V

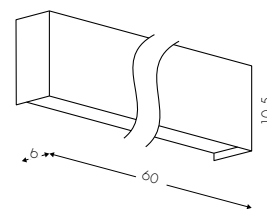

2019COF

84W 10800lm - 220V

2019CDM

DALI (Push) - 84W 10800lm - 220V

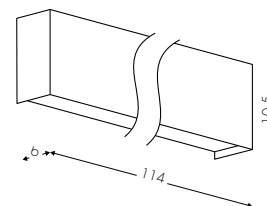

2019DOF

126W 16000lm - 220V

2019DDM

DALI (Push) - 126W 16000lm - 220V

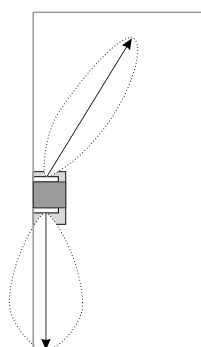
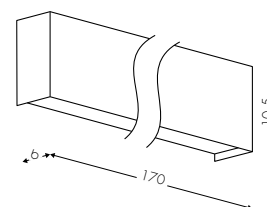

DISTRIBUZIONE
LUMINOSA
LIGHTING EMISSION
LICHT EMISSION



A E19 UGR<19



A 2700K **B** 3000K **C** 4000K

BV NE RU



TF Taglio di Fase - Phase-Cut Dimmer - Phasenabschnittdimmer

A Alimentatore Incorporato - Incorporated Power Supply - Eingebautes Netzteil

Esempio - Example - Beispiel *
2700lm con - with - mit **E19**

302 indice fotografico







2019EOF
2019EDM
2019ETF

14W 2100lm* - 220V
DALI (Push) - 14W 2100lm - 220V
14W 2100lm - 220V

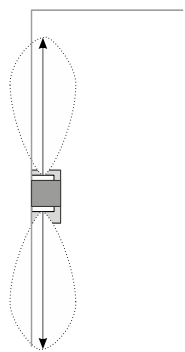
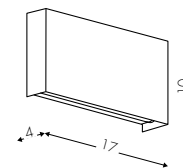

DISTRIBUZIONE
LUMINOSA
LIGHTING EMISSION
LICHT EMISSION

CUSTOM RV OV BR



A E19 UGR<19

● **A** 2700K ● **B** 3000K ○ **C** 4000K

BV NE RU

TF Taglio di Fase - Phase-Cut Dimmer - Phasenabschnittdimmer

A Alimentatore Incorporato - Incorporated Power Supply - Eingebautes Netzteil

Esempio - Example - Beispiel *
2100lm con - with - mit **E19**







SIMPLY

Potente lampada a parete monoemissione con ottica asimmetrica e potente emissione di luce indiretta.

Wall lamp with single light emission, asymmetric optics and powerful indirect flux.

Mono-Emission Wandleuchte mit asymmetrischer Optik und von oben starker indirekter Lichtemission.

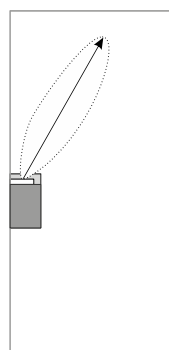

DISTRIBUZIONE
LUMINOSA
LIGHTING EMISSION
LICHT EMISSION

2019AOFUP 21W 2700lm* - 220V
2019ADMUP DALI (Push) 21W 2700lm - 220V
2019ATFUP 21W 2700lm - 220V

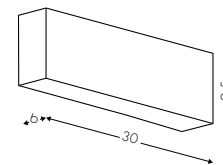

2019BOFUP 42W 5300lm - 220V
2019BDMUP DALI (Push) 42W 5300lm - 220V
2019BTFUP 42W 5300lm - 220V

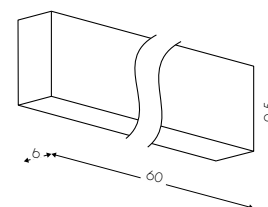

2019COFUP 84W 10800lm - 220V
2019CDMUP DALI (Push) 84W 10800lm - 220V
2019COFUPEM 84W 10800lm - 220V

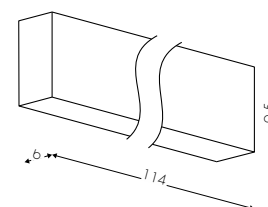

A E19 UGR<19

● **A** 2700K ● **B** 3000K ○ **C** 4000K

BV **NE** **RU**

EM Emergenza - Emergency - Notbeleuchtung
TF Taglio di Fase - Phase-Cut Dimmer - Phasenabschrittdimmer
A Alimentatore Incorporato - Incorporated Power Supply - Eingebautes Netzteil

Esempio - Example - Beispiel *
 2700lm con - with - mit **E19**







SIMPLY

Potente lampada a parete monoemissione con ottica asimmetrica e potente emissione di luce indiretta.

Wall lamp with single light emission, asymmetric optics and powerful indirect flux.

Mono-Emission Wandleuchte mit asymmetrischer Optik und von oben starker indirekter Lichtemission.

2019EOFUP

7W 1100lm* - 220V

2019EDMUP

DALI (Push) 7W 1100lm - 220V

2019ETFUP

7W 1100lm - 220V

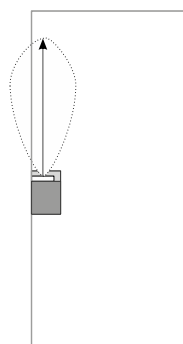
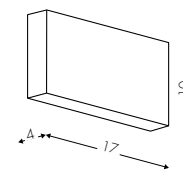

DISTRIBUZIONE
LUMINOSA
LIGHTING EMISSION
LICHT EMISSION



E19 UGR<19



A 2700K



B 3000K



C 4000K

BV NE RU



TF Taglio di Fase - Phase-Cut Dimmer - Phasenabschnittdimmer

A Alimentatore Incorporato - Incorporated Power Supply - Eingebautes Netzteil

Esempio - Example - Beispiel *

1100lm con - with - mit **E19**







 
MADE in ITALY

310

Collezione di apparecchi
dalla forma geometrica
semplice e regolare. Emissione
luminosa potente, diffusa con
diffusore satinato.

Collection of lamps with a simple
and regular geometric shape and
powerful light emission. Diffused
light with frosted diffuser.

Leuchtensammlung mit leichter
und regelmäßiger geometrischer
Form und starker Lichtemission.
Streulicht mit satiniertem Diffusor.



OKI

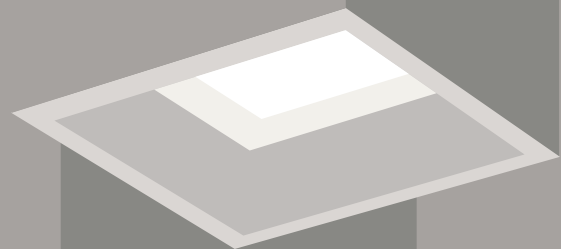



OKI

Linee minimali e corpo in alluminio, la gamma OKI led soffitto e parete offre un'illuminazione diffusa adatta a tutti gli ambienti.

Minimal lines and aluminum body, OKI, available in ceiling or wall version, provides a diffused lighting suitable for all the environments.

Mit ihren minimalen Linien und einem Lampenkörper aus Aluminium, ergeben die OKI LED Decken- und Wandleuchten eine diffuse Beleuchtung, die sich jeder Umgebung anpassen.



3009CTF 20W 1700lm* - 220V

3009COFEM 20W 1700lm - 220V

 **E28** Satinato - Frosted - Satiniert  **A** 2700K  **B** 3000K  **C** 4000K

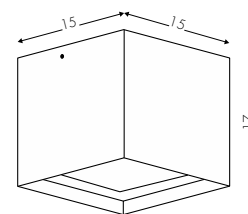

3009COF28 18W 2500lm - 220V

3009CDM28 DALI (Push) - 18W 2500lm - 220V

3009CTF28 18W 2500lm - 220V

 **28°** Ottica - Optics - Optik  **B** 3000K  **C** 4000K

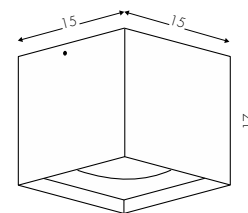

EM Emergenza - Emergency - Notbeleuchtung

TF Taglio di Fase - Phase-Cut Dimmer - Erhältlich Phasenabschnittdimmer

A Alimentatore Incorporato - Incorporated Power Supply - Eingebautes Netzteil

Esempio - Example - Beispiel *

1700lm con - with - mit **E28**







- 3009EOF** 18W 2200lm* - 220V
- 3009EDM** DALI (Push) - 18W 2200lm - 220V
- 3009ETF** 18W 2200lm - 220V
- 3009EOFEM** 18W 2200lm - 220V

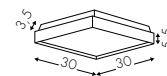

- 3009FOF** 50W 6200lm - 220V
- 3009FDM** DALI (Push) - 50W 6200lm - 220V
- 3009FTF** 50W 6200lm - 220V
- 3009FOFEM** 50W 6200lm - 220V

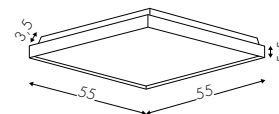

- 3009LOF** 50W 6200lm - 220V
- 3009LDM** DALI (Push) - 50W 6200lm - 220V
- 3009LTF** 50W 6200lm - 220V
- 3009LOFEM** 50W 6200lm - 220V

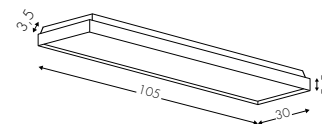

A E2 Opale - Opal
E19 UGR<19 Prism

B 3000K **C** 4000K



- EM** Emergenza - Emergency - Notbeleuchtung
- TF** Taglio di Fase - Phase-Cut Dimmer - Erhältlich Phasenabschnittdimmer
- A** Alimentatore Incorporato - Incorporated Power Supply - Eingebautes Netzteil

Esempio - Example - Beispiel *
2200lm con - with - mit **E19** - 2200lm - 1.5% con - with - mit **E2**







Soluzione orientabile per la luce d'accento, ideata per valorizzare con la luce gli elementi d'arredo illuminandoli singolarmente o per agevolare specifici tasks visivi.

Orientable solution for accent lighting, designed to enhance with light the furnishing elements or to facilitate specific visual tasks.

Eine orientierbare Lösung für Akzentbeleuchtung, entwickelt um Einrichtungselemente aufzuwerten, oder um bestimmte visuelle Ziele zu erleichtern.





MICRO



MICRO

Apparecchio orientabile per la luce focalizzata disponibile nelle versioni ad uno o due proiettori. Alimentatore incorporato On-Off o dimmerabile.

Adjustable device for focused light available with one or two projectors version.
Incorporated on-off or dimmable power supply.

Einstellbares Gerät für konzentriertes Licht, mit einem oder zwei Scheinwerfer verfügbar.
On-Off oder dimmbares eingebautes Netzteil.

**3039AOF**

3W 360lm* - 220V

3039ADM

DALI (Push) - 3W 360lm - 220V

3039ATF

3W 360lm - 220V

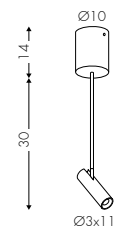
**3039BOF**

2x3W 2x360lm - 220V

3039BDM

DALI (Push) - 2x3W 2x360lm - 220V

3039BTF

2x3W 2x360lm - 220V

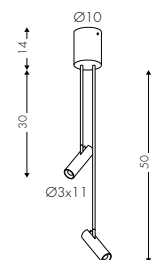

24° Ottica - Optic - Optik



B 3000K



C 4000K

**TF** Taglio di Fase - Phase-Cut Dimmer - Phasenabschrittdimmer**A** Alimentatore Incorporato - Incorporated Power Supply - Eingebautes Netzteil

Esempio - Example - Beispiel *

360lm con - with - mit 24°







Soluzione a plafone che coniuga luce concentrata orientabile e diffusa generica ad alto flusso luminoso.
Alimentatore incorporato on-off o dimmerabile.

Ceiling version that combines concentrated adjustable light and generic diffused bright flux.
Incorporated on-off or dimmable power supply.

Deckenleuchte Lösung, die ein einstellbares und konzentriertes Licht mit einem hohem Lichtstrom zusammen kombiniert. On-Off oder dimmbar es eingebautes Netzteil.

3039EOF

2x3W 2x360lm + 15W 1500lm* - 220V

3039EDM

DALI (Push) - 2x3W 2x360lm + 15W 1500lm - 220V

3039ETF

2x3W 2x360lm + 15W 1500lm - 220V

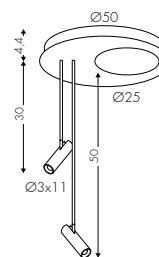

A + **E2** Opale - Opal
24° Ottica - Optic - Optik

● **B** 3000K ○ **C** 4000K



TF Taglio di Fase - Phase-Cut Dimmer - Phasenabschrittdimmer

A Alimentatore Incorporato - Incorporated Power Supply - Eingebautes Netzteil

Esempio - Example - Beispiel *

1500lm con - with - mit **E2**







4039A

3W 360lm* - 350mA - 9V

Alimentatore - Power supply - Netzteil

AE006A

OnOff 10W 350mA / 1-3 art. 4039A

AE007A

DALI (Push) 19,2W 350mA / 1-5 art. 4039A

AE008D

PHASE CUT (Dimmer) 10,5W 350mA / 1-2 art. 4039A

AE008B

PHASE CUT (Dimmer) 18W 350mA / 3-5 art. 4039A

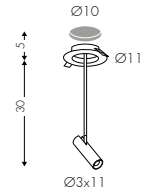

4039B

2x3W 2x360lm - 350mA - 18V

Alimentatore - Power supply - Netzteil

AE006A

OnOff 10W 350mA / 1 art. 4039B

AE007A

DALI (Push) 19,2W 350mA / 1-2 art. 4039B

AE008A

PHASE CUT (Dimmer) 10,5W 350mA / 1 art. 4039B

AE008B

PHASE CUT (Dimmer) 18W 350mA / 2 art. 4039B

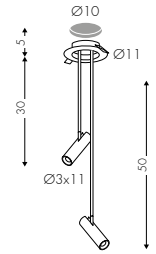

A 24° Ottica - Optic - Optik

● B 3000K ○ C 4000K



A Alimentatore non incluso - Power Supply not included - Netzteil nicht inbegriffen

Esempio - Example - Beispiel *
360lm con - with - mit **24°**





Famiglia di prodotti tecnici che grazie alla forma ed alle finiture dialogano armoniosamente con l'ambiente. Il movimento semplice e preciso delle sorgenti luminose focalizzate di Operà è un'opportunità per l'interior designer di estrarre visivamente i dettagli dello spazio esaltandone qualità e geometria.

Family of technical products that, thanks to their shape and finishes, harmoniously interact with the environment.

The simple and precise movement of the focused light sources of Operà is an opportunity for the interior designer to visually extract the details of the space, enhancing its quality and geometry.

Technische Produktfamilie die, dank ihrer Form und Feinbearbeitungen, sich harmonisch mit der Umgebung unterhalten.

Die einfache und präzise Bewegung der konzentrierten Lichtquellen von Opera bieten dem Interior Designer die Gelegenheit die Details des Raums visuell herauszuziehen um sie zu verbessern in Qualität und Geometrie.

A stylized graphic of a theater stage. The stage floor is a light gray trapezoid, and the walls and ceiling are dark gray. A spotlight shines from above, creating a bright white circle on the stage floor. The word "OPERA" is written in white, bold, sans-serif capital letters across the bottom of the image, with the spotlight circle partially overlapping the letter 'A'.

OPERA



OPERÀ

Elementi a plafone con una due o tre sorgenti luminose orientabili con lente concentrante.

Corpo in metallo verniciato a polveri o a liquido nelle finiture speciali.

Alimentatore incorporato On-Off o dimmerabile DALI.

Ceiling elements with one, two or three adjustable light sources with concentrating lens.

Metal body powder coated or liquid coated in special finishes. Built-in On-Off or dimmable DALI power supply.

Deckenleuchte Elemente mit eine, zwei oder drei verstellbaren Lichtquellen mit konzentrierter Linse.

Pulver- oder flüssiglackierter Metallkörper als sonder Feinbearbeitungen.

On-Off oder dimmbares eingebautes Netzteil.

**3033AOF**

1x7W 680lm* - 220V

3033ATF

1x7W 680lm - 220V

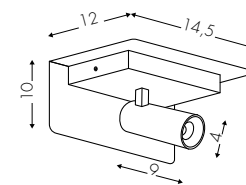
**3033BOF**

2x7W 2x680lm - 220V

3033BDM

DALI (Push) - 2x7W 2x680lm - 220V

3033BTF

2x7W 2x680lm - 220V

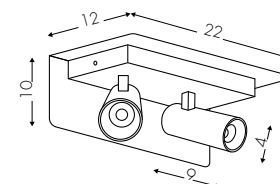
**3033COF**

3x7W 3x680lm - 220V

3033CDM

DALI (Push) - 3x7W 3x680lm - 220V

3033CTF

3x7W 3x680lm - 220V

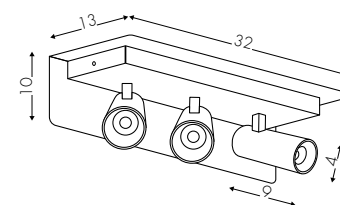
**A**

24° Ottica - Optic - Optik

● B 3000K

○ C 4000K

**TF** Taglio di Fase - Phase-Cut Dimmer - Erhältlich Phasenabschnittdimmer**A** Alimentatore Incorporato - Incorporated Power Supply - Eingebautes Netzteil

Esempio - Example - Beispiel *

680lm con - with - mit **24°**





3033EOF
3033EDM
3033ETF

25W 2860lm* + 2x7W 2x680lm - 220V

DALI (Push) - 25W 2860lm + 2x7W 2x680lm - 220V

25W 2860lm + 2x7W 2x680lm - 220V

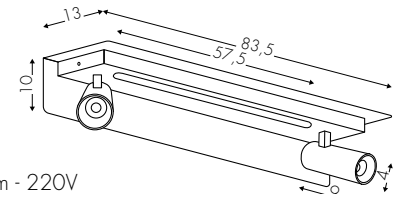

A + E2 Opale - Opal
24° Ottica - Optic - Optik

 B 3000K

 C 4000K



TF Taglio di Fase - Phase-Cut Dimmer - Erhältlich Phasenabschnittdimmer

A Alimentatore Incorporato - Incorporated Power Supply - Eingebautes Netzteil

Esempio - Example - Beispiel *

2860lm con - with - mit 24°







4033AOF
4033ADM
4033ATF

1x7W 680lm* - 220V
DALI (Push) - 1x7W 1x680lm - 220V
1x7W 680lm - 220V

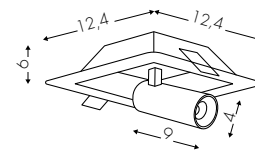

4033BOF
4033BDM
4033BTF

2x7W 2x680lm - 220V
DALI (Push) - 2x7W 2x680lm - 220V
2x7W 2x680lm - 220V

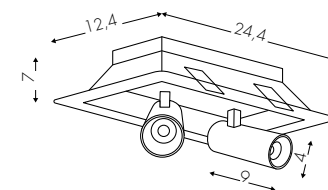

4033COF
4033CDM
4033CTF

3x7W 3x680lm - 220V
DALI (Push) - 3x7W 3x680lm - 220V
3x7W 3x680lm - 220V

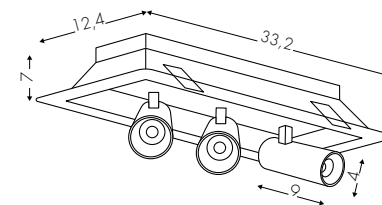

24° Ottica - Optic - Optik

● B 3000K

○ C 4000K

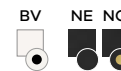

TF Taglio di Fase - Phase-Cut Dimmer - Erhältlich Phasenabschnittdimmer

A Alimentatore Incluso in remoto - Included Power Supply in remote - Fernspeisung enthalten

Esempio - Example - Beispiel *
680lm con - with - mit **24°**







4033EOF
4033EDM
4033ETF

25W 2860lm* + 2x7W 2x680lm - 220V
 DALI (Push) - 25W 2860lm + 2x7W 2x680lm - 220V
 25W 2860lm + 2x7W 2x680lm - 220V

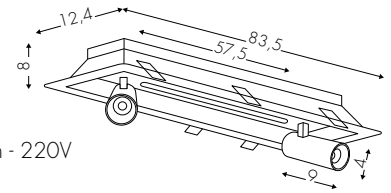

4033FOF
4033FDM
4033FTF

25W 2860lm + 2x7W 2x680lm - 220V
 DALI (Push) - 25W 2860lm + 2x7W 2x680lm - 220V
 25W 2860lm + 2x7W 2x680lm - 220V

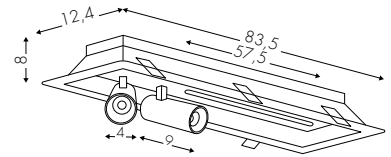

B 3000K C 4000K



TF Taglio di Fase - Phase-Cut Dimmer - Erhältlich Phasenabschnittdimmer
A Alimentatore Incluso in remoto - Included Power Supply in remote - Fernspeisung enthalten

Esempio - Example - Beispiel *
 2860lm con - with - mit 24°







 
MADE in ITALY

Famiglia di prodotti tecnici che, grazie alla forma ed alle finiture, dialoga armoniosamente con l'ambiente.
Il movimento semplice e preciso delle sorgenti luminose focalizzate di Tablet Round è un'opportunità per l'interior designer di estrarre visivamente i dettagli dello spazio esaltandone qualità e geometria.

Family of technical products that, thanks to their shape and finishes, harmoniously interact with the environment.
The simple and precise movement of the focused light sources of Tablet Round is an opportunity for the interior designer to visually extract the details of the space, enhancing its quality and geometry.

Technische Produktfamilie die, dank ihrer Form und Feinbearbeitungen, sich harmonisch mit der Umgebung unterhalten.
Die einfache und präzise Bewegung der konzentrierten Lichtquellen von Tablet Round bieten dem Interior Designer die Gelegenheit die Details des Raums visuell herauszuziehen um den in Qualität und Geometrie zu verbessern.





**TABLET
ROUND**



TABLET ROUND

Elementi a plafone con una o più sorgenti luminose orientabili con lenti concentranti per l'illuminazione d'accento.

Corpo in metallo verniciato a polveri o a liquido nelle finiture speciali disponibili con alimentatore incorporato On-Off o dimmerabile DALI.

Ceiling lamp with one or more adjustable light sources with concentrating lens for accent lighting.

Metal body powder coated or liquid coated in special finishes available with built-in On-Off or dimmable DALI power supply.

Deckenleuchten mit einer oder mehreren einstellbaren Lichtquellen mit konzentrierten Linsen für die Akzent Beleuchtung. Pulverbeschichtet oder lackierter Metallkörperaus speziellen Ausführungen, erhältlich mit integriertem On-Off oder dimmbarem DALI-Netzteil.

**3044POF**

1x7W 1x680lm* - 220V

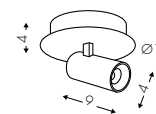
**3044QOF**

2x7W 2x680lm - 220V

3044QDM

DALI (Push) 2x7W 2x680lm - 220V

3044QTF

2x7W 2x680lm - 220V

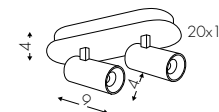
**3044GOF**

3x7W 3x680lm - 220V

3044GDM

DALI (Push) 3x7W 3x680lm - 220V

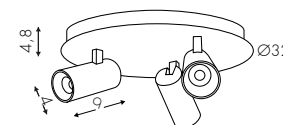

CUSTOM



24° Ottica - Optic - Optik

B 3000K

C 4000K

**TF** Taglio di Fase - Phase-Cut Dimmer - Erhältlich Phasenabschnittdimmer**A** Alimentatore Incorporato - Incorporated Power Supply - Eingebautes Netzteil

Esempio - Example - Beispiel *
680lm con - with - mit **24°**







TABLET ROUND

Lampada a plafone con doppia sorgente luminosa: diffusa generica e concentrata grazie a due proiettori orientabili.
Alimentatore incorporato On/Off e dimmerabile.

Ceiling light combining concentrated light in two adjustable light sources and general diffused luminous flux. The On-Off or dimmable DALI power supply is incorporated in the body lamp.

Deckenleuchte, die konzentriertes Licht in zwei einstellbaren Licht-Quellen und diffuse Lichtstrom kombiniert. On/Off oder dimmbar DALI eingebautes Netzteil.

3044SOF
3044SDM
3044STF

25W 2860lm* + 2x7W 2x680lm - 220V

DALI (Push) - 25W 2860lm + 2x7W 2x680lm - 220V

25W 2860lm + 2x7W 2x680lm - 220V

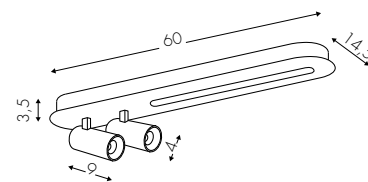

A + **E2** Opale - Opal
24° Ottica - Optic - Optik

● **B** 3000K ○ **C** 4000K



TF Taglio di Fase - Phase-Cut Dimmer - Erhältlich Phasenabschnittdimmer

A Alimentatore Incorporato - Incorporated Power Supply - Eingebautes Netzteil

Esempio - Example - Beispiel *

2860lm con - with - mit **E2**







3044T

1xGU10 max 7W LED - 220V

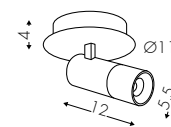

3044U

2xGU10 max 7W LED - 220V

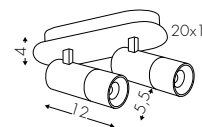

GU10 Sorgente non inclusa - Not included light source - Lichtquelle nicht enthalten







TABLET ROUND

Elementi ad incasso con una o più sorgenti luminose orientabili con lente concentrante per l'illuminazione d'accento.

Corpo in metallo verniciato a polveri o a liquido nelle finiture speciali disponibili con alimentatore incorporato On-Off o dimmerabile DALI.

Recessed lamp with one or more adjustable light sources with concentrating lens for the accent light.

Metal body powder coated or liquid coated in special finishes available with built-in On-Off or dimmable DALI power supply.

Einbauleuchte mit einer oder mehreren einstellbaren Lichtquellen mit konzentrierten Linsen für die Akzentbeleuchtung.

Metallkörper pulverbeschichtet oder flüssigkeitsbeschichtet in speziellen Ausführungen, erhältlich mit integriertem On-Off oder dimmbarem DALI-Netzteil.



4044P 7W 680lm* - 350mA 20V

Alimentatore - Power supply - Netzteil

AE006A OnOff 10W 350mA / 1 art. 4044P

AE006B OnOff 16W 350mA / 2 art. 4044P

AE007A DALI (Push) 19,2W 350mA / 1-2 art. 4044P

AE008A PHASE CUT (Dimmer) 10W 350mA / 1 art. 4044P

AE008B PHASE CUT (Dimmer) 18W 350mA / 2 art. 4044P

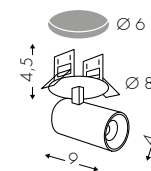

4044Q 2x7W 2x680lm - 350mA 40V

Alimentatore - Power supply - Netzteil

AE006B OnOff 16W 350mA / 1 art. 4044Q

AE007A DALI (Push) 19,2W 350mA / 1 art. 4044Q

AE008B PHASE CUT (Dimmer) 18W 350mA / 1 art. 4044Q

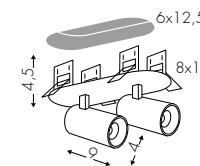

4044U 13W 1300lm - 350mA 36V

Alimentatore - Power supply - Netzteil

AE006B OnOff 16W 350mA / 1 art. 4044U

AE007A DALI (Push) 19,2W 350mA / 1 art. 4044U

AE008B PHASE CUT (Dimmer) 18W 350mA / 1 art. 4044U

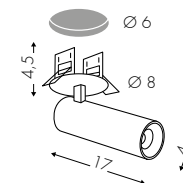

24° Ottica - Optic - Optik



B 3000K



C 4000K



A Alimentatore non incluso - Power Supply not included - Netzteil nicht inbegriffen



4044D

1xGU10 max 7W LED - 220V

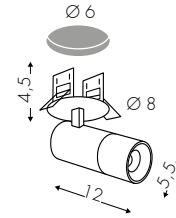

4044E

2xGU10 max 7W LED - 220V

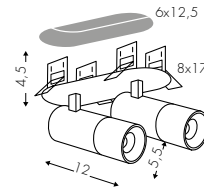

GU10 Sorgente non inclusa - Not included light source - Lichtquelle nicht enthalten



 
MADE in ITALY

Famiglia di prodotti tecnici che, grazie alla forma ed alle finiture, dialoga armoniosamente con l'ambiente.
Il movimento semplice e preciso delle sorgenti luminose focalizzate di Tablet Square è un'opportunità per l'interior designer di estrarre visivamente i dettagli dello spazio esaltandone qualità e geometria.

Family of technical products that, thanks to their shape and finishes, harmoniously interact with the environment.
The simple and precise movement of the focused light sources of Tablet Square is an opportunity for the interior designer to visually extract the details of the space, enhancing its quality and geometry.

Technische Produktfamilie die, dank ihrer Form und Feinbearbeitungen, sich harmonisch mit der Umgebung unterhalten.
Die einfache und präzise Bewegung der konzentrierten Lichtquellen von Tablet Square bieten dem Interior Designer den Gelegenheit die Details des Raums visuell herauszuziehen, um den in Qualität und Geometrie zu verbessern.



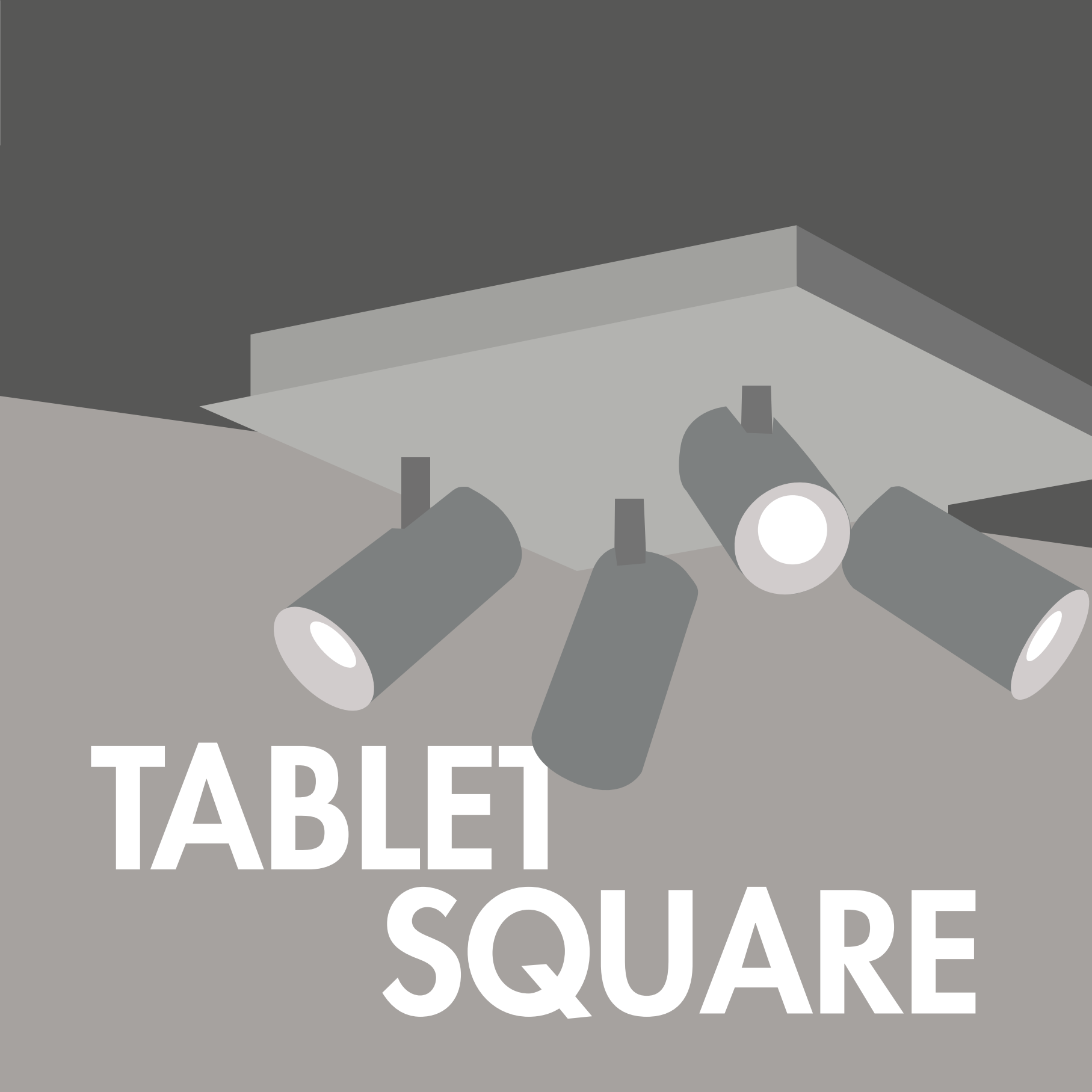

TABLET SQUARE



TABLET SQUARE

Elementi a plafone con una o più sorgenti luminose orientabili con lente concentrante per l'illuminazione d'accento.

Corpo in metallo verniciato a polveri o a liquido nelle finiture speciali disponibili con alimentatore incorporato On-Off o dimmerabile DALI.

Ceiling lamps with one or more adjustable light sources with concentrated lenses for accent lighting.

Metal body powder-coated or liquid-coated in special finishes. Incorporated On-Off or dimmable DALI power supply.

Deckenleuchten mit einer oder mehreren einstellbaren Lichtquellen mit konzentrierten Linsen zur Akzentbeleuchtung.

Pulverbeschichtet oder lackierter Metallkörper, in speziellen Ausführungen erhältlich. Integriertes On/off oder dimmbares DALI Netzteil.

3044MOF

1x7W 1x680lm* - 220V

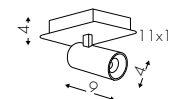
**3044NOF**

2x7W 2x680lm - 220V

3044NDM

DALI (Push) 2x7W 2x680lm - 220V

3044NTF

2x7W 2x680lm - 220V

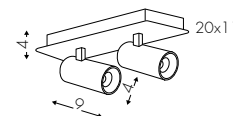
**3044FOF**

4x7W 4x680lm - 220V

3044FDM

DALI (Push) - 4x7W 4x680lm - 220V

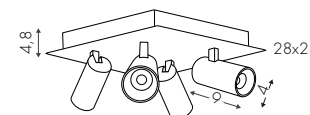

CUSTOM



24° Ottica - Optic - Optik



B 3000K



C 4000K

**TF** Taglio di Fase - Phase-Cut Dimmer - Erhältlich Phasenabschnittdimmer**A** Alimentatore Incorporato - Incorporated Power Supply - Eingebautes Netzteil

Esempio - Example - Beispiel *

680lm con - with - mit **24°**





30440

1xGU10 max 7W LED - 220V

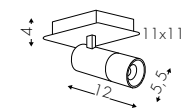

3044V

2xGU10 max 7W LED - 220V

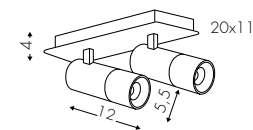

GU10 Sorgente non inclusa - Not included light source - Lichtquelle nicht enthalten







TABLET SQUARE

Elementi ad incasso con una o più sorgenti luminose orientabili con lenti concentranti per l'illuminazione d'accento.

Corpo in metallo verniciato a polveri o a liquido nelle finiture speciali disponibili con alimentatore incorporato On-Off o dimmerabile DALI.

Recessed lamps with one or more adjustable light sources with concentrating lens for the accent light.

The metal body, powder or liquid coated in special finishes, includes an On/Off or dimmable DALI power supply.

Einbauleuchte mit einer oder mehreren einstellbaren Lichtquellen mit konzentrierten Linsen für die Akzentbeleuchtung. Pulverbeschichtet oder lackierter Metallkörper, in speziellen Ausführungen erhältlich. Integriertes On/off oder dimmbar DALI Netzteil.

4044M

7W 680lm* - 350mA 20V

Alimentatore - Power supply - Netzteil

AE006A OnOff 10W 350mA / 1 art. 4044M

AE006B OnOff 16W 350mA / 2 art. 4044M

AE007A DALI (Push) 19,2W 350mA / 1-2 art. 4044M

AE008A PHASE CUT (Dimmer) 10W 350mA / 1 art. 4044M

AE008B PHASE CUT (Dimmer) 18W 350mA / 2 art. 4044M

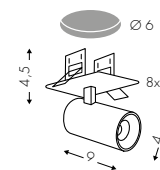

4044N

2x7W 2x680lm - 350mA 40V

Alimentatore - Power supply - Netzteil

AE006B OnOff 16W 350mA / 1 art. 4044N

AE007A DALI (Push) 19,2W 350mA / 1 art. 4044N

AE008B PHASE CUT (Dimmer) 18W 350mA / 1 art. 4044N

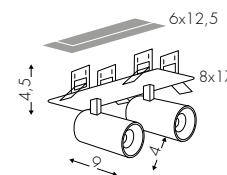

4044R

13W 1300lm - 350mA 36V

Alimentatore - Power supply - Netzteil

AE006B OnOff 16W 350mA / 1 art. 4044R

AE007A DALI (Push) 19,2W 350mA / 1 art. 4044R

AE008B PHASE CUT (Dimmer) 18W 350mA / 1 art. 4044R

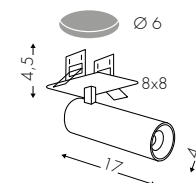

24° Ottica - Optic - Optik



B 3000K



C 4000K

BV NE



A Alimentatore non incluso - Power Supply not included - Netzteil nicht inbegriffen

Esempio - Example - Beispiel *
680lm con - with - mit 24°



4044A

1xGU10 max 7W LED - 220V

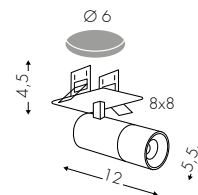

4044B

2xGU10 max 7W LED - 220V

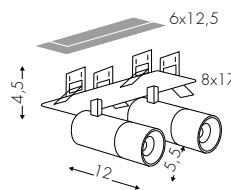

GU10 Sorgente non inclusa - Not included light source - Lichtquelle nicht enthalten



MADE in ITALY

Lampada ad incasso per cartongesso eccezionalmente luminosa.
La sorgente opportunamente arretrata con diffusore microprismatizzato, visivamente confortevole, illumina valorizzando le superfici del prodotto, in particolare nelle finiture speciali oro, rame e bronzo.

Recessed light for plasticboard exceptionally bright.
The appropriately set back light source with micro-prismatic diffuser is visually comfortable and lights up the surfaces of the product, enhancing the special gold, copper and bronze finishes.

Einbauleuchte für Gipskarton.
Die zurückgesetzte Licht-Quelle mit einem mikro-prismatischem Diffusor ist optisch komfortabel und hebt die Oberflächen des Produkts hervor, insbesondere in den speziellen Gold-, Kupfer- und Bronzeausführungen.





RETRO



RETRO

Lampade ad incasso arretrato con alimentatore incluso e remoto. Corpo in metallo e diffusore in Policarbonato microprismatizzato. Disponibili finiture speciali oro, rame e bronzo.

Recessed lamps with set back light source. The included power supply is remotely included. Metal light body and microprismatic polycarbonate diffuser. Special gold, copper and bronze finishes available.

Einbauleuchten mit integriertem und fernbedienbarem Netzteil. Metall Leuchtkörper und mikro-prismatisch Polycarbonat Diffusor. Spezielle Gold, Kupfer und Bronze Oberflächen stehen zur Verfügung.

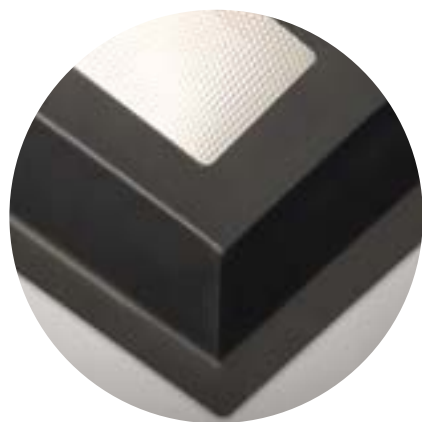

4041GOF
4041GDM
4041GTF

15W - 1800lm* - 220V
DALI (Push) 15W - 1800lm - 220V
PHASE CUT (Dimmer) 15W - 1800lm - 220V

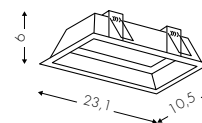

4041HOF
4041HDM
4041HTF

25W - 3300lm - 220V
DALI(Push) 25W - 3300lm - 220V
PHASE CUT (Dimmer) 25W - 3300lm - 220V

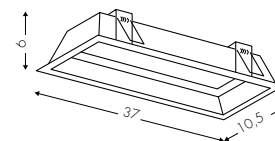

4041IOF
4041IDM

50W - 6000lm - 220V
DALI (Push) 50W - 6000lm - 220V

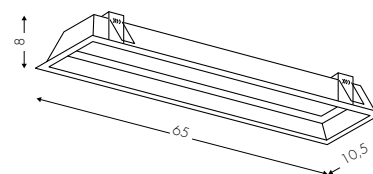

CUSTOM RV BR OV



BV NE



CE E IP20 **E19** UGR<19 Prism **A** 2700K **B** 3000K **C** 4000K

TF Taglio di Fase - Phase-Cut Dimmer - Phasenabschnittdimmer

A↑ Alimentatore Incluso remoto - Included Power Supply in remote - Fernspeisung enthalten







 
MADE in ITALY

356

Le ottiche progettate per illuminare dove serve sono il cuore illuminotecnico di Task, una famiglia di elementi a plafone e ad incasso dove la sorgente luminosa diventa invisibile e lascia spazio solo al suo effetto nell'ambiente.

Optics designed to illuminate where it is needed. This is Task, a family of ceiling and recessed elements where the light source becomes invisible and leaves space only for its effect in the room.

Optik, die darauf ausgelegt ist, dort zu leuchten, wo es gebraucht wird. Das ist Task, eine Familie von Decken- und Einbauelementen, bei denen die Lichtquelle unsichtbar wird und nur noch Platz für ihre Wirkung im Raum lässt.



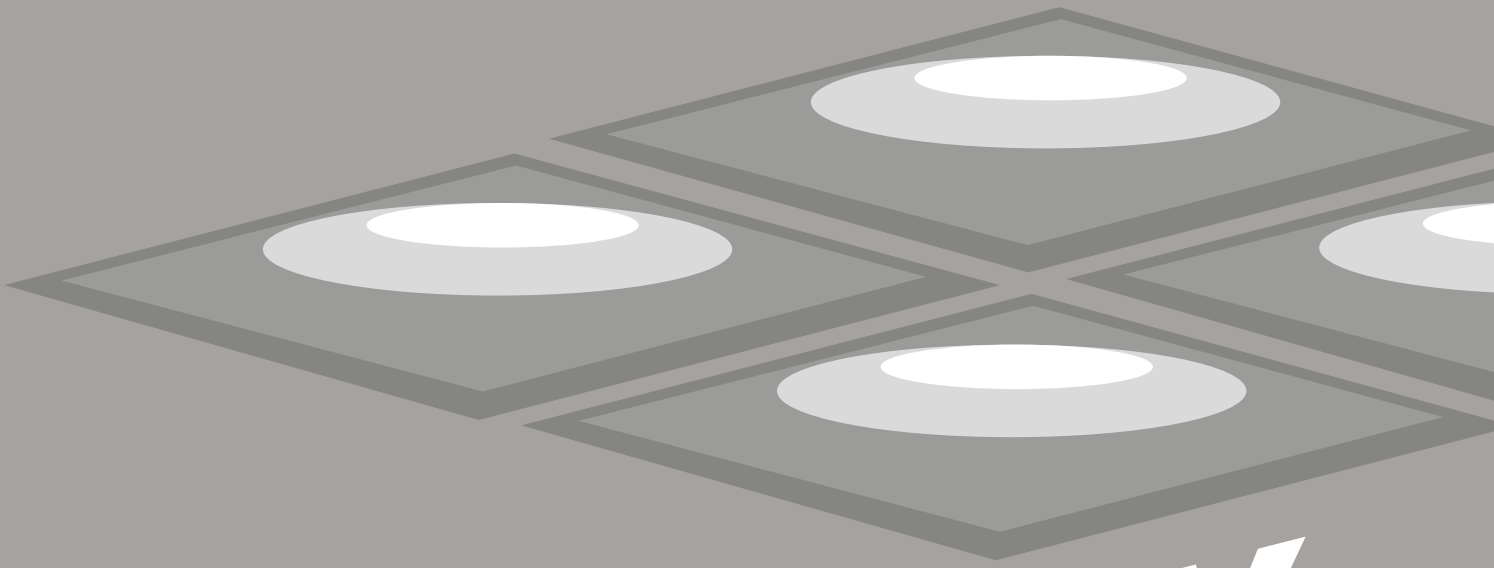

TASK



TASK

Elementi a plafone dotati di ottica fissa dark-light per l'illuminazione d'accento.

Corpo in alluminio verniciato a polveri, alimentatore integrato.

Ceiling lamps with fixed dark-light optic for accent lighting. Aluminium powder-coated body lamp, with integrated power supply.

Deckenleuchte mit feststehender dark-light-Optik für die Akzentbeleuchtung. Pulverbeschichtetes Aluminiumkörper, mit integriertem Netzteil.

**3048COF**

10W 960lm* - 220V

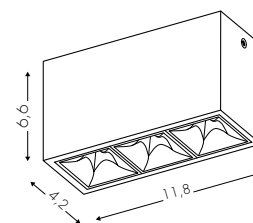
**3048DOF**

12W 1200lm - 220V

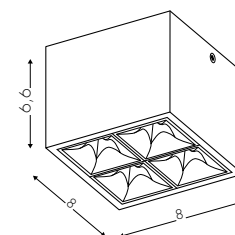
**38°** Ottica - Optic - Optik● **B** 3000K**A** Alimentatore Incorporato - Incorporated power supply - Eingebautes Netzteil





TASK

Elementi ad incasso per cartongesso dotati di ottica fissa dark-light per l'illuminazione d'accento. Corpo in alluminio verniciato a polveri, alimentatore remoto non incluso.

Recessed lamps with fixed dark-light optic for accent lighting. Aluminium powder-coated body lamp, with integrated power supply.

Einbauleuchte mit feststehender dark-light-Optik für die Akzentbeleuchtung. Pulverbeschichtetes Aluminiumkörper, mit integriertem Netzteil.



- 4048A** 4W 400lm* - 150mA 30V
Alimentatore - Power supply - Netzteil
AE006E OnOff 6W 150mA / 1 art. 4048A
AE008F PHASE CUT (Dimmer) 20W 150mA / 1 art. 4048A

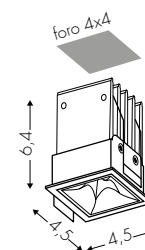

- 4048B** 7,5W 900lm - 250mA - 30V
Alimentatore - Power supply - Netzteil
AE006D OnOff 9W 250mA / 1 art. 4048B
AE007C DALI (Push) 10W 250mA / 1 art. 4048B
AE008F PHASE CUT (Dimmer) 20W 250mA / 1 art. 4048B

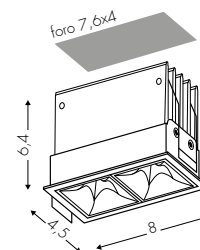

- 4048C** 15W 1500lm - 500mA - 36V
Alimentatore - Power supply - Netzteil
AE006F OnOff 20W 500mA / 1 art. 4048C
AE007B DALI (Push) 25W 500mA / 1 art. 4048C
AE008F PHASE CUT (Dimmer) 20W 500mA / 1 art. 4048C

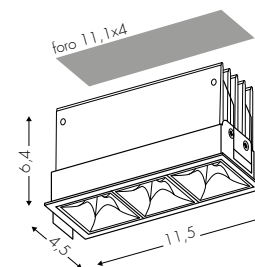

- 4048D** 18W - 1800lm - 600mA - 30V
Alimentatore - Power supply - Netzteil
AE006G OnOff 24W 600mA / 1 art. 4048D
AE007B DALI (Push) 25W 600mA / 1 art. 4048D
AE008F PHASE CUT (Dimmer) 20W 600mA / 1 art. 4048D

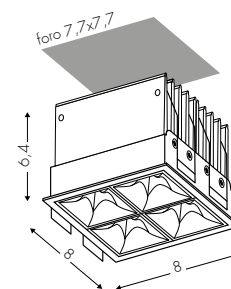

24° Ottica - Optic Optik

B 3000K

BV

Alimentatore non incluso - Power supply not included - Netzteil nicht inbegriffen

Esempio - Example - Beispiel *
400lm con - with - mit 24°







 
MADE in ITALY

362

Punti luce ad emissione
asimmetrica ideati per
evidenziare il soggetto
illuminandolo con precisione e
limitando l'abbagliamento.

Asymmetric emission spot lights
designed to highlight the object
with precision and limiting the
glare.

Asymmetrische Lichtemission
Lichtpunkte, die das Objekt
präzise hervorheben und
Blendungsschutz garantieren.



SIDE





SIDE

Incassi arretrati con ottica asimmetrica concentrata. Struttura in alluminio verniciato a polveri di forma circolare o quadrata. Alimentatore remoto non incluso.

Recessed spotlights with asymmetric focused light source. Circular or squared shape, power or liquid aluminium coated.

The power supply, remotely placed, is not included.

Einbaustrahler mit asymmetrischer konzentrierte Lichtquelle. Kreis- oder quadratische Form, Pulver- oder flüssigaluminiumbeschichtet. Die Fernspeisung ist nicht enthalten.



- 4057A** 13W 1300lm* - 350mA 36V
 Alimentatore - Power supply - Netzteil
AE006B OnOff 16W 350mA / 1 art. 4057A
AE007A DALI (Push) 19,2W 350mA / 1 art. 4057A
AE008B PHASE CUT (Dimmer) 18W 350mA / 1 art. 4057A

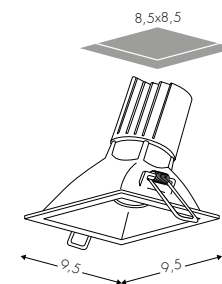

- 4057B** 10W 1300lm - 500mA 20V
 Alimentatore - Power supply - Netzteil
AE006F OnOff 20W 500mA / 1 art. 4057B
AE007B DALI (Push) 25W 500mA / 1 art. 4057B
AE008F PHASE CUT (Dimmer) 20W 500mA / 1 art. 4057B

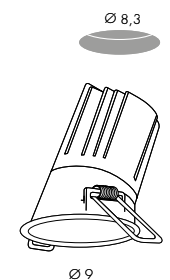

24° Ottica - Optic Optik

B 3000K



 Alimentatore non incluso - Power supply not included - Netzteil nicht inbegriffen

Esempio - Example - Beispiel *
 1300lm con - with - mit 24°







S-pot, una famiglia completa di soluzioni dal design minimale e dalla flessibilità estrema d'impiego, per l'illuminazione d'accento.

S-pot is a complete collection of minimal design elements, ideal for accent lighting.

S-pot ist eine komplette Kollektion von minimalen Designelementen, ideal für Akzentbeleuchtung.





S-POT



S-POT

Lampada a plafone e a sospensione con diffusore o ottica 24° nella versione H22cm. Alimentatore integrato.

Ceiling and pendant lamp with led light source or 24° optics. Integrated power supply.

Decken- und Pendelleuchte mit Led-Lichtquelle und 24 Grad Optik. Eingebautes Netzteil.



1018ATF 17W 1500lm* - 220V

■ **E28** Satinato - Frosted - Satiniert ● **A** 2700K ● **B** 3000K ○ **C** 4000K

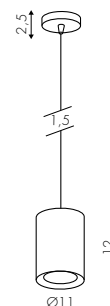

1018BOF 26W 3400lm - 220V

1018BDM DALI (Push) - 26W 3400lm - 220V

1018BTF 26W 3400lm - 220V

■ **24°** Ottica - Optic - Optik ● **B** 3000K ○ **C** 4000K

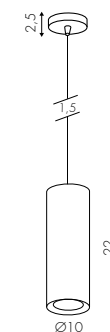

TF Taglio di Fase - Phase-Cut Dimmer - Erhältlich Phasenabschnittdimmer

A Alimentatore Incorporato - Incorporated Power Supply - Eingebautes Netzteil

Esempio - Example - Beispiel *

1500lm con - with - mit **E28**







3018ATF

3018ATF 17W 1500lm* - 220V

 **E28** Satinato - Frosted - Satiniert  **A** 2700K  **B** 3000K  **C** 4000K

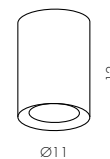

3018BOF 26W 3400lm - 220V

3018BDM DALI (Push) - 26W 3400lm - 220V

3018BTF 26W 3400lm - 220V

 **24°** Ottica - Optic - Optik   **B** 3000K  **C** 4000K

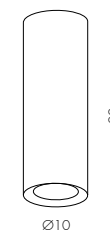

TF Taglio di Fase - Phase-Cut Dimmer - Erhältlich Phasenabschnittdimmer
A Alimentatore Incorporato - Incorporated Power Supply - Eingebautes Netzteil

Esempio - Example - Beispiel *
1500lm con - with - mit **E28**







3018GOF

26W 2600lm* - 220V

3018GDM

DALI (Push) - 26W 2600lm - 220V

3018GTF

26W 2600lm - 220V

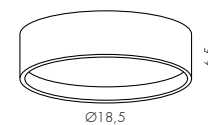

E2 Opale - Opal

B 3000K



TF Taglio di Fase - Phase-Cut Dimmer - Erhältlich Phasenabschrittdimmer

A Alimentatore Incorporato - Incorporated Power Supply - Eingebautes Netzteil

Esempio - Example - Beispiel *

2600lm con - with - mit **E2**







S-POT PROIETTORE

Lampada orientabile a binario con sorgente luminosa a led. Alimentatore integrato.

Adjustable track light spotlight with led light source. Integrated power supply.

Drehbare Stromschiene Schienenlichter mit Led-Lichtquelle. Eingebautes Netzteil.

T018EOF
T018EDM

18W 2070lm* - 220V
DALI (Push) - 18W 2070lm - 220V

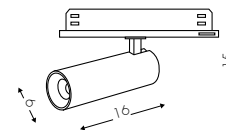

A 24° Ottica - Optic - Optik



B 3000K



C 4000K

BV **NE**



A Alimentatore Incorporato - Incorporated Power Supply - Eingebautes Netzteil

Esempio - Example - Beispiel *
2070lm con - with - mit 24°







S-POT INCASSO

Lampada ad incasso con sorgente luminosa arretrata. Ottica a luce concentrata ed alimentatore incluso remoto.

Recessed spotlight with set-back light source. Concentrated optics and remotely included power supply.

Einbaustrahler mit zurückgesetzter Lichtquelle. Konzentrierte Optik und Fernspeisung enthalten.



4017IOF

9W 1000lm* - 220V

4017ITF

9W 1000lm - 220V

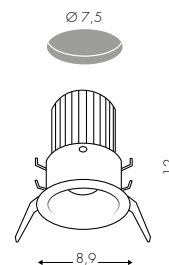

4017LOF

18W 2000lm - 220V

4017LTF

18W 2000lm - 220V

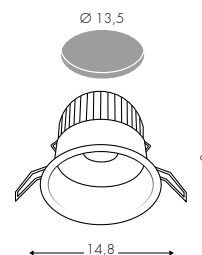

4017MOF

26W 3000lm - 220V

4017MTF

26W 3000lm - 220V

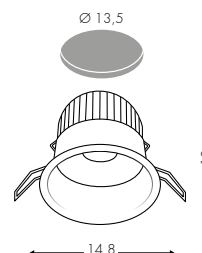

36° Ottica - Optic - Optik

B 3000K

C 4000K

BV **NE**



TF Taglio di Fase - Phase-Cut Dimmer - Erhältlich Phasenabschnittdimmer

A↑ Alimentatore Incluso in remoto - Included Power Supply in remote - Fernspeisung enthalten

Esempio - Example - Beispiel *

1000lm con - with - mit **36°**







4017TF

13W 1300lm* - 220V

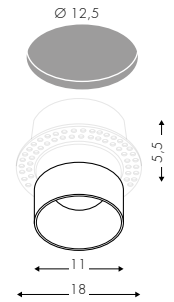

9017F

Controcassa - Outer Casing - Einbauhülse

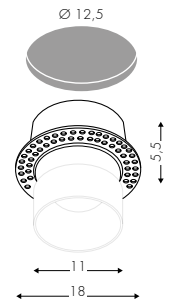

E28 Satinato - Satin - Satiniert

B 3000K

C 4000K



TF Taglio di Fase - Phase-Cut Dimmer - Erhältlich Phasenabschnittdimmer

A Alimentatore Incorporato - Incorporated Power Supply - Eingebautes Netzteil

Esempio - Example - Beispiel *

1300lm con - with - mit **E28**







4017S

7W 680lm* - 350mA 20V

Alimentatore - Power supply - Netzteil

AE006A OnOff 10W 350mA / 1 art. 4017S

AE006B OnOff 16W 350mA / 2 art. 4017S

AE007A DALI (Push) 19,2W 350mA / 1-2 art. 4017S

AE008A PHASE CUT (Dimmer) 10W 350mA / 1 art. 4017S

AE008B PHASE CUT (Dimmer) 18W 350mA / 2 art. 4017S

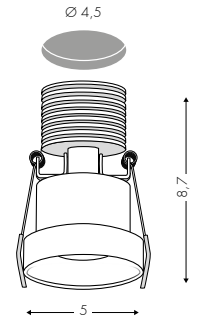

A 24° Ottica - Optic - Optik

B 3000K



A Alimentatore non incluso - Power Supply not included - Netzteil nicht inbegriffen

Esempio - Example - Beispiel *
680lm con - with - mit **24°**







4017T 5W 480lm* - 500mA 10V

Alimentatore - Power supply - Netzteil

AE006N OnOff 20W 500mA / 1-4 art. 4017T

AE007B DALI (Push) 25W 500mA / 2-4 art. 4017T

AE008F PHASE CUT (Dimmer) 20W 500mA / 1-4 art. 4017T

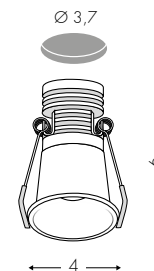

A 24° Ottica - Optic - Optik

B 3000K



A Alimentatore non incluso - Power Supply not included - Netzteil nicht inbegriffen

Esempio - Example - Beispiel *
480lm con - with - mit **24°**







4017N

9W 1000lm* - 350mA 30V

Alimentatore - Power supply - Netzteil

AE006A OnOff 10W 350mA / 1 art. 4017N

AE007A DALI (Push) 19,2W 350mA / 1 art. 4017N

AE008D PHASE CUT (Dimmer) 10W 350mA / 1 art. 4017N

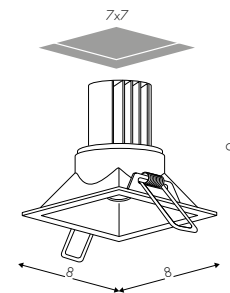

A 36° Ottica - Optic - Optik

B 3000K

C 4000K



A Alimentatore non incluso - Power Supply not included - Netzteil nicht inbegriffen

Esempio - Example - Beispiel *
1000lm con - with - mit 36°







La famiglia di profili a led TI si caratterizza per ampiezza e completezza di soluzioni, offrendo al contempo la massima flessibilità progettuale in termini di flusso luminoso, tipologia di montaggio.

TI led profiles are characterized by a wide range of solutions, offering the maximum flexibility in terms of design and type of installation.

Die Profileuchte Familie mit TI Led-Lichtquelle bietet eine breite und komplette Wahl an Lösungen und versichert zugleich maximale Planung-Flexibilität in Bezug auf Lichtquelle, Einbauart.



PROFILI



Parete / Plafone
Wall / Ceiling profile
Wand- / Deckenleuchte

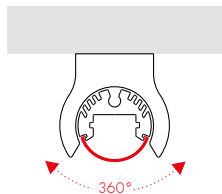

p. 390

6010



Plafone / Sottopensile
Ceiling light / Under cabinet light
Deckenleuchte / Unterschranklampe

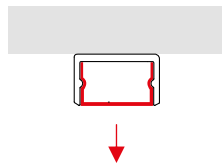

p. 398

3010F



Plafone
Ceiling profile
Deckenleuchte

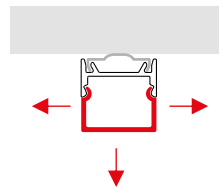

p. 406

3010



Plafone
Ceiling profile
Deckenleuchte

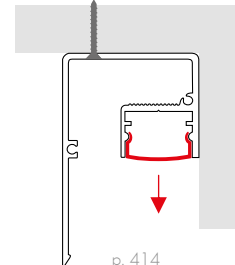

p. 414

40100



Parete / Plafone
Wall / Ceiling profile
Wand- / Deckenleuchte

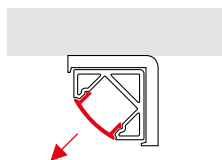

p. 394

8010



Parete / Plafone
Wall / Ceiling profile
Wand- / Deckenleuchte

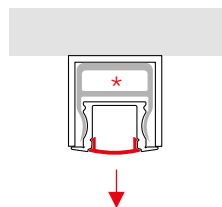

p. 402

3010E



Plafone
Ceiling profile
Deckenleuchte

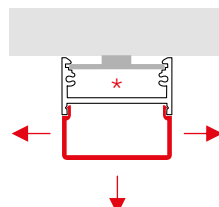

p. 410

3010M



Parete / Rasomuro
Wall light / Wall flush effect
Wandleuchte / Wandbindung Effekt

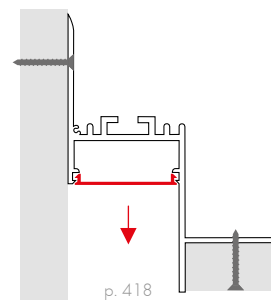

p. 418

4010H



* possibilità di passaggio cavo/possible cable passage/Eventueller Kabeldurchgang

■ cartongesso/plasterboard/gipskarton

■ muratura/brickwork/Mauerwerk

▼ rasatura/ plaster skimming/Gipsglättung



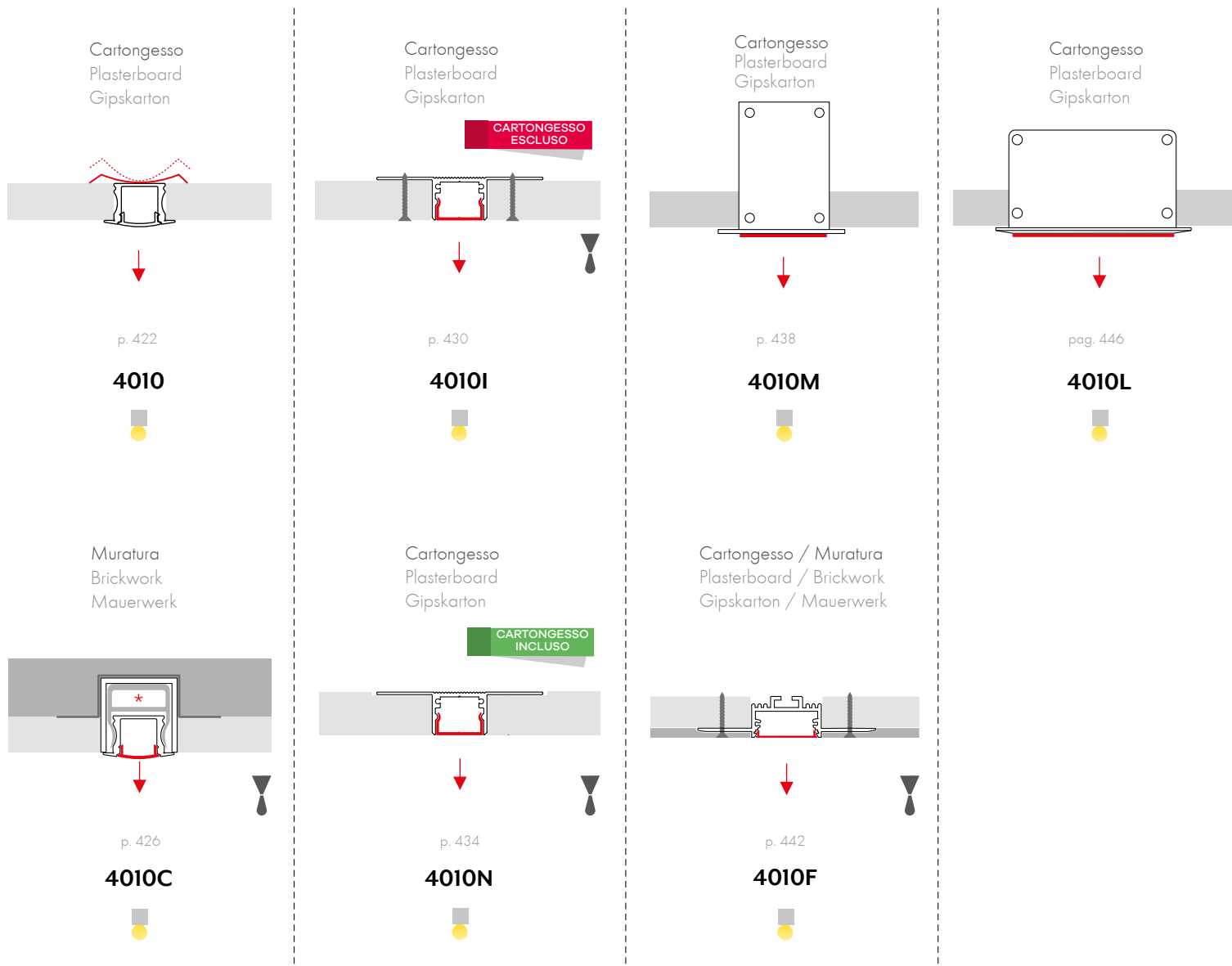



6010 - Orientabile 360°

Profilo 360 in alluminio ideale quando si desidera orientare il fascio di luce. Il profilo è tagliato in misura, completo di strip led e con tutti gli accessori per l'installazione (alimentatore escluso).

The 360 aluminium profile is the ideal product to orient the light flux. This profile, cut to size, is equipped with the led strip and all the accessories for the installation. (The power supply is not included).

Das Aluminiumprofil 360 ist das ideale Produkt zur Ausrichtung des Lichtstroms. Dieses Profil, auf Maß geschnitten, ist mit dem Led-Streifen und dem gesamten Zubehör für die Installation ausgestattet. (Das Netzteil ist nicht enthalten).

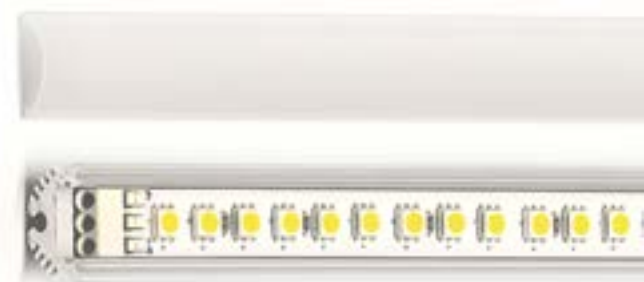
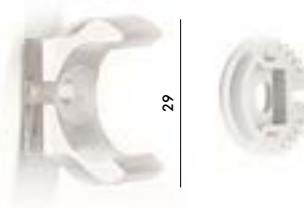
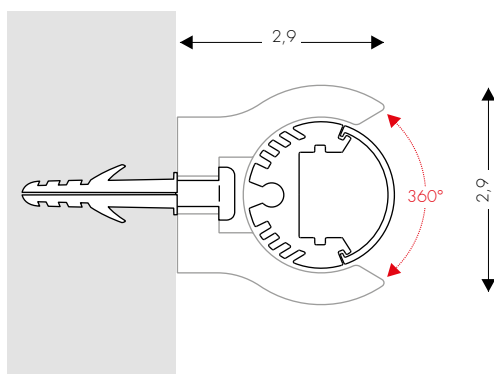

390

indice fotografico

indice famiglia







6010 - Orientabile 360°

6010V11	10-63cm 14.4W/mt 1600lm*/mt - 24VDC
6010V21	64-123cm 14.4W/mt 1600lm/mt - 24VDC
6010V31	124-183cm 14.4W/mt 1600lm/mt - 24VDC
6010V41	184-243cm 14.4W/mt 1600lm/mt - 24VDC
6010V51	244-323cm 14.4W/mt 1600lm/mt - 24VDC
6010V61	324-383cm 14.4W/mt 1600lm/mt - 24VDC

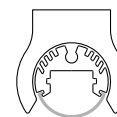

6010B1	384-500cm 14.4W/mt 1600lm/mt - 24VDC
---------------	--------------------------------------

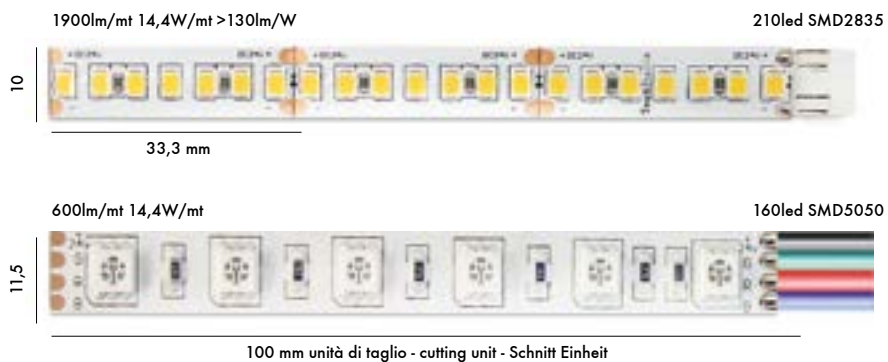
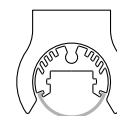

E2 Opale - Opal

E28 Satinato - Frosted - Satiniert

● A 2700K

● B 3000K

○ C 4000K

● E RGB

BV

AL



Alimentatore non incluso - Power Supply not included - Netzteil nicht inbegriffen

Alimentatore Incluso remoto - Included Power Supply in remote - Fernspeisung enthalten

Esempio - Example - Beispiel *

1600lm con - with - mit E28 - 1600lm - 15% con - with - mit E2



22W/mt

6010V13	10-63cm 22W/mt 2300lm*/mt - 24VDC
6010V23	64-123cm 22W/mt 2300lm/mt - 24VDC
6010V33	124-183cm 22W/mt 2300lm/mt - 24VDC
6010V43	184-243cm 22W/mt 2300lm/mt - 24VDC
6010V53	244-323cm 22W/mt 2300lm/mt - 24VDC
6010V63	324-383cm 22W/mt 2300lm/mt - 24VDC

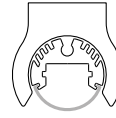

6010B3	384-500cm 22W/mt 2300lm/mt - 24VDC
---------------	------------------------------------

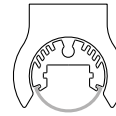

 **E2** Opale - Opal
 **E28** Satinato - Frosted - Satiniert

 **A** 2700K  **B** 3000K  **C** 4000K

BV  **AL** 

 Alimentatore non incluso - Power Supply not included - Netzteil nicht inbegriffen

 Alimentatore Incluso remoto - Included Power Supply in remote - Fernspeisung enthalten

Esempio - Example - Beispiel *

2300lm con - with - mit **E28** - 2300lm - 1.5% con - with - mit **E2**



8010 - Angolare

Profilo angolare dalle dimensioni contenute ideale per l'illuminazione indiretta delle pareti. Il profilo è fornito tagliato in misura, completo di strip led e con tutti gli accessori per l'installazione (alimentatore escluso).

This small-sized angled profile is ideal to indirectly light up the walls. This product is equipped with all the accessories for the installation (the driver is not included).

Dieses kleinformatige Winkelprofil ist ideal, um die Wände indirekt zu beleuchten. Dieses Produkt ist mit allen Zubehörteilen für die Installation ausgestattet (das Netzteil ist nicht enthalten).

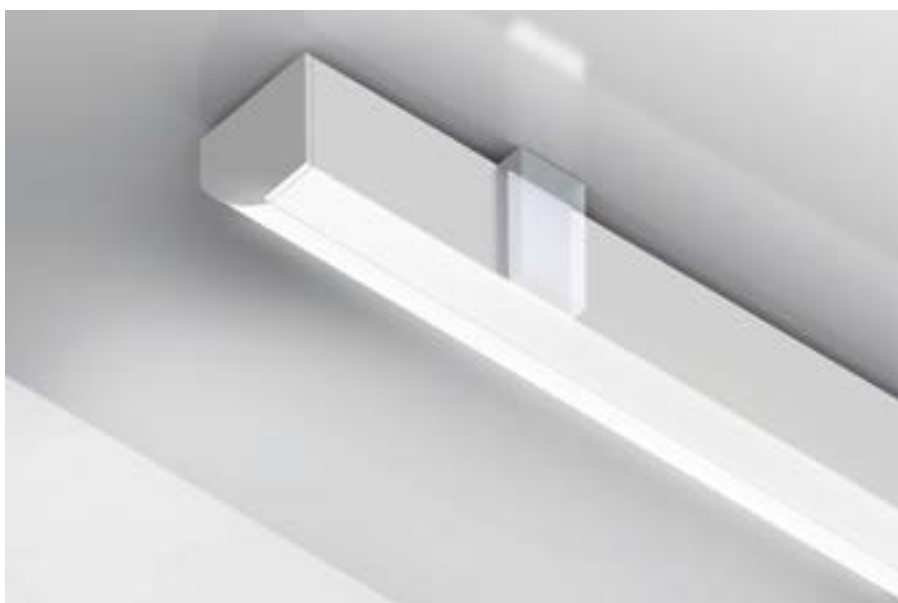
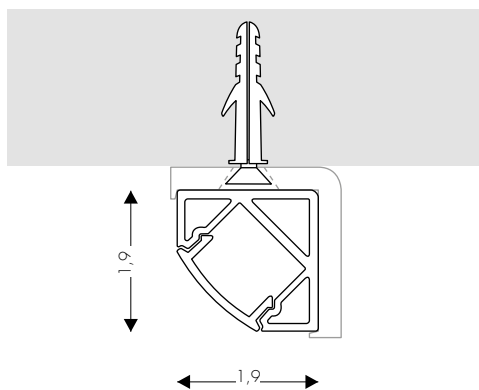





8010 - ANGOLARE

8010V11	10-63cm 14.4W/mt 1600lm*/mt - 24VDC
8010V21	64-123cm 14.4W/mt 1600lm/mt - 24VDC
8010V31	124-183cm 14.4W/mt 1600lm/mt - 24VDC
8010V41	184-243cm 14.4W/mt 1600lm/mt - 24VDC
8010V51	244-323cm 14.4W/mt 1600lm/mt - 24VDC
8010V61	324-383cm 14.4W/mt 1600lm/mt - 24VDC

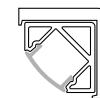

8010B1	384-500cm 14.4W/mt 1600lm/mt - 24VDC
---------------	--------------------------------------

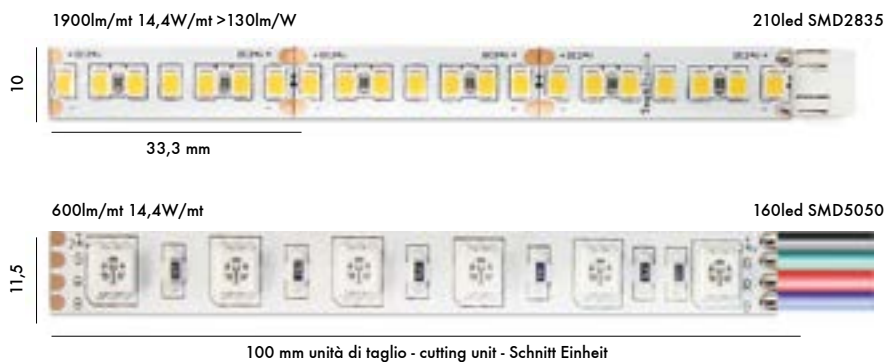

 Alimentatore non incluso - Power Supply not included - Netzteil nicht inbegriffen

 Alimentatore Incluso remoto - Included Power Supply in remote - Fernspeisung enthalten

Esempio - Example - Beispiel *

1600lm con - with - mit **E28** - 1600lm - 15% con - with - mit **E2**



22W/mt

8010V13	10-63cm 22W/mt 2300lm*/mt - 24VDC
8010V23	64-123cm 22W/mt 2300lm/mt - 24VDC
8010V33	124-183cm 22W/mt 2300lm/mt - 24VDC
8010V43	184-243cm 22W/mt 2300lm/mt - 24VDC
8010V53	244-323cm 22W/mt 2300lm/mt - 24VDC
8010V63	324-383cm 22W/mt 2300lm/mt - 24VDC



8010B3	384-500cm 22W/mt 2300lm/mt - 24VDC
--------	------------------------------------



E2 Opale - Opal
E28 Satinato - Frosted - Satiniert

● A 2700K ● B 3000K ○ C 4000K

BV AL
□ ■

Alimentatore non incluso - Power Supply not included - Netzteil nicht inbegriffen

Alimentatore Incluso remoto - Included Power Supply in remote - Fernspeisung enthalten

Esempio - Example - Beispiel *

2300lm con - with - mit E28 - 2300lm - 1.5% con - with - mit E2



Profilo Basic

Massime prestazioni nel minimo ingombro identificano il "profilo Basic": uno strumento essenziale ed efficiente da usare in molteplici modalità, anche incorporato in elementi d'arredo.

Small size and maximum performance for the Basic Profile: an essential and efficient light that can be used in multiple contexts and environments.

Kleine Größe und maximale Leistung für das Basic-Profil: eine unverzichtbare und effiziente Leuchte, die in verschiedenen Kontexten und Umgebungen eingesetzt werden kann.

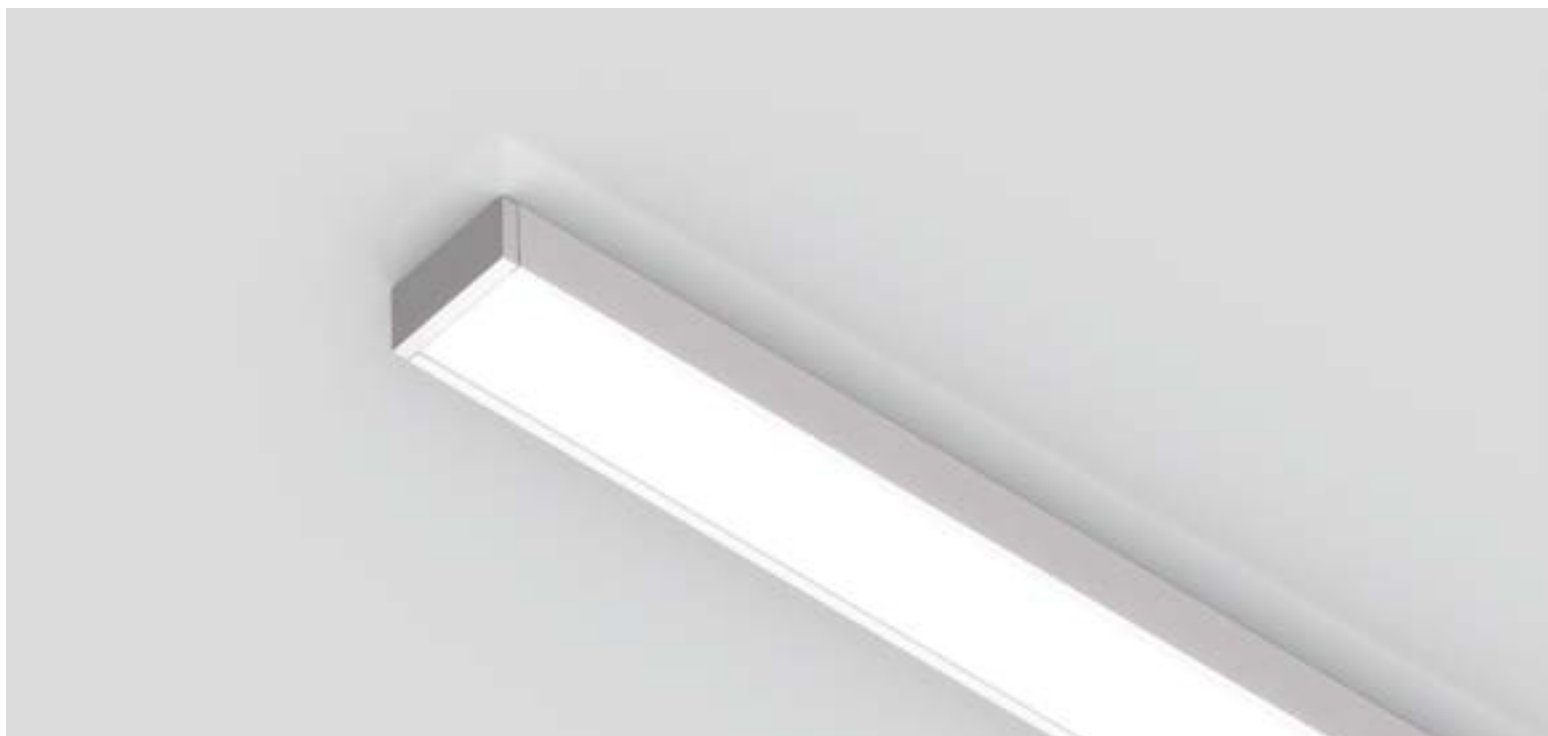
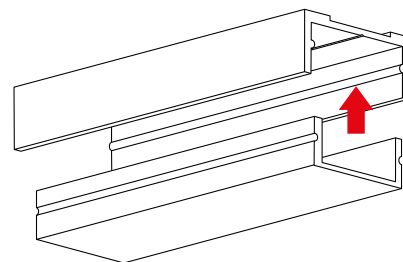
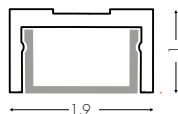





14.4W/mt

3010F - BASIC

3010FV11	10-63cm 14.4W/mt 1600lm*/mt - 24VDC
3010FV21	64-123cm 14.4W/mt 1600lm/mt - 24VDC
3010FV31	124-183cm 14.4W/mt 1600lm/mt - 24VDC
3010FV41	184-243cm 14.4W/mt 1600lm/mt - 24VDC
3010FV51	244-323cm 14.4W/mt 1600lm/mt - 24VDC
3010FV61	324-383cm 14.4W/mt 1600lm/mt - 24VDC



3010FB1	384-500cm 14.4W/mt 1600lm/mt - 24VDC
----------------	--------------------------------------

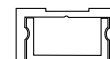

 E2 Opale - Opal
 E28 Satinato - Frosted - Satiniert
  A 2700K
  B 3000K
  C 4000K
  E RGB
  BV
  AL

 Alimentatore non incluso - Power Supply not included - Netzteil nicht inbegriffen

 Alimentatore Incluso remoto - Included Power Supply in remote - Fernspeisung enthalten

Esempio - Example - Beispiel *

1600lm con - with - mit **E28** - 1600lm - 15% con - with - mit **E2**

400

indice fotografico

indice famiglia





1900lm/mt 14,4W/mt >130lm/W

210led SMD2835



600lm/mt 14,4W/mt

160led SMD5050



100 mm unità di taglio - cutting unit - Schnitt Einheit



3010E - Plafone S

Profilo a plafone dalle dimensioni contenute con controcassa che consente il passaggio del cavo di alimentazione al suo interno. Il profilo è tagliato in misura, completo di strip led e con tutti gli accessori per l'installazione (alimentatore escluso).

This small-sized ceiling profile is equipped with an outer casing that allows the cable passage. This product, cut to size, is supplied with the led strip and all the accessories for the installation (the power supply is not included).

Lineare Deckenleuchte aus beschränkten Ausmaßen mit einem Hinter-Gehäuse ausgestattet, dass die Durchführung des Netzkabels. Plafone S wird Maßgeschnitten geliefert, mit Strip Led und allen nötigen Zubehören für die Montage. Das Netzteil ist nicht enthalten.

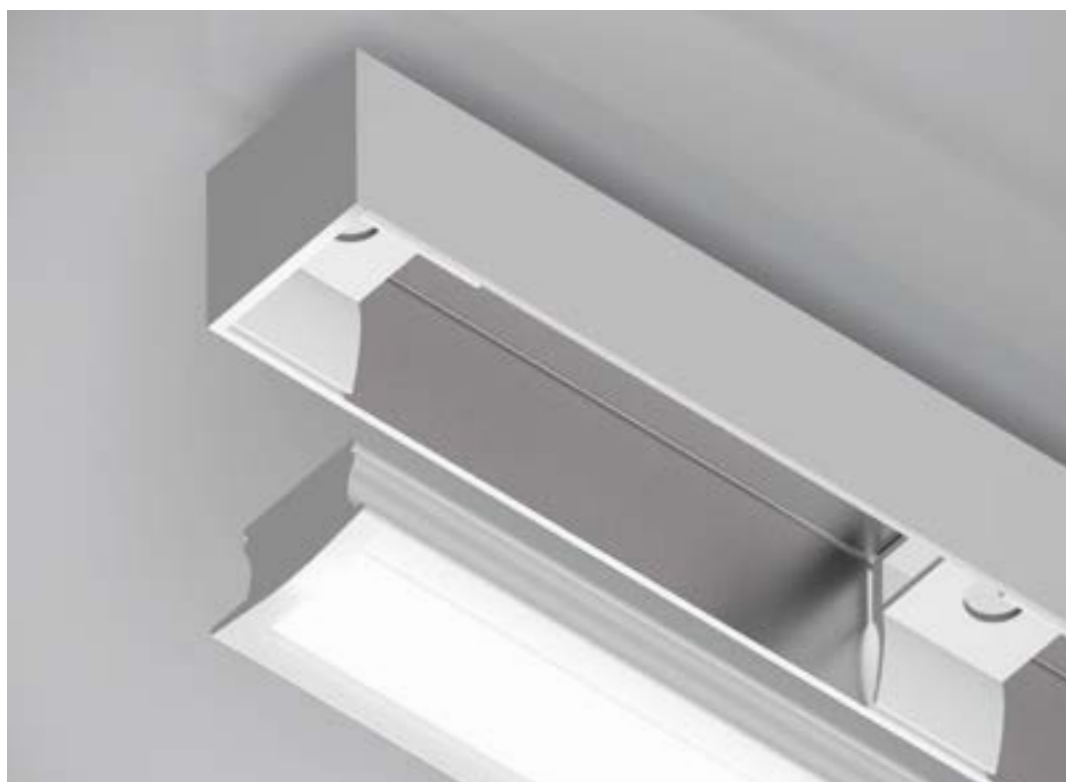
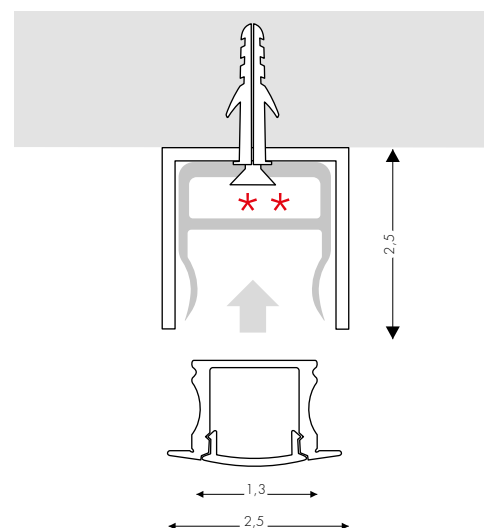
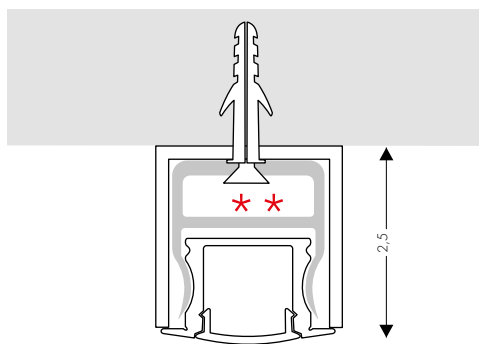

**Possibilità passaggio cavo
Possible cable passage
Eventueller Kabeldurchgang







3010E - PLAFONE S

3010EV11	10-63cm 14.4W/mt 1600lm*/mt - 24VDC
3010EV21	64-123cm 14.4W/mt 1600lm/mt - 24VDC
3010EV31	124-183cm 14.4W/mt 1600lm/mt - 24VDC
3010EV41	184-243cm 14.4W/mt 1600lm/mt - 24VDC
3010EV51	244-323cm 14.4W/mt 1600lm/mt - 24VDC
3010EV61	324-383cm 14.4W/mt 1600lm/mt - 24VDC

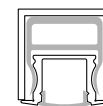

3010EB1	384-500cm 14.4W/mt 1600lm/mt - 24VDC
----------------	--------------------------------------

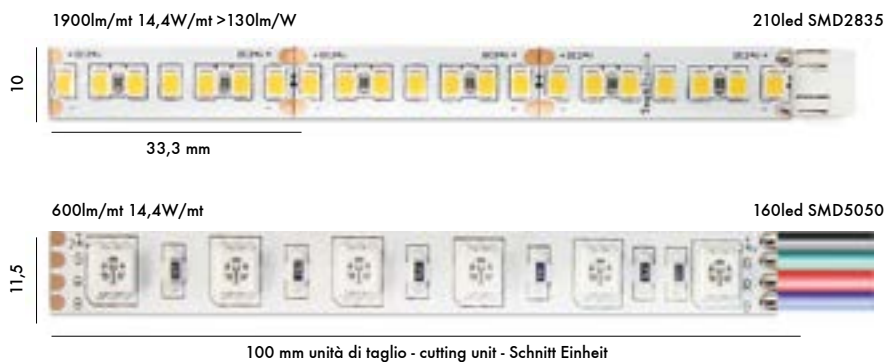

A Alimentatore non incluso - Power Supply not included - Netzteil nicht inbegriffen
A↑ Alimentatore Incluso remoto - Included Power Supply in remote - Fernspeisung enthalten

Esempio - Example - Beispiel *
 1600lm con - with - mit **E28** - 1600lm - 15% con - with - mit **E2**



22W/mt

3010EV13	10-63cm 22W/mt 2300lm*/mt - 24VDC
3010EV23	64-123cm 22W/mt 2300lm/mt - 24VDC
3010EV33	124-183cm 22W/mt 2300lm/mt - 24VDC
3010EV43	184-243cm 22W/mt 2300lm/mt - 24VDC
3010EV53	244-323cm 22W/mt 2300lm/mt - 24VDC
3010EV63	324-383cm 22W/mt 2300lm/mt - 24VDC

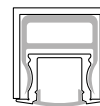

3010EB3	384-500cm 22W/mt 2300lm/mt - 24VDC
----------------	------------------------------------

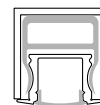

■ E2 Opale - Opal
● E28 Satinato - Frosted - Satiniert

● A 2700K ● B 3000K ○ C 4000K

BV NE
□ ■

A Alimentatore non incluso - Power Supply not included - Netzteil nicht inbegriffen

A↑ Alimentatore Incluso remoto - Included Power Supply in remote - Fernspeisung enthalten

Esempio - Example - Beispiel *

2300lm con - with - mit **E28** - 2300lm - 1.5% con - with - mit **E2**



3010 - Profilo multiuso

Profilo multiuso small in alluminio con emissione luminosa diffusa diretta e laterale. Il profilo è tagliato in misura, completo di strip led e con tutti gli accessori per l'installazione (alimentatore escluso).

Small-sized aluminium ceiling light with down and side light emission. This product is equipped with the led strip and all the accessories for the installation (the power supply is not included).

Kleinformatige Aluminium-Deckenleuchte mit Lichtaustritt nach unten und zur Seite. Dieses Produkt ist mit dem Led-Streifen und dem gesamten Zubehör für die Installation ausgestattet (das Netzteil ist nicht enthalten).

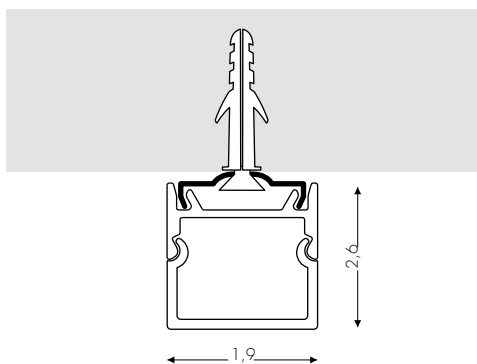

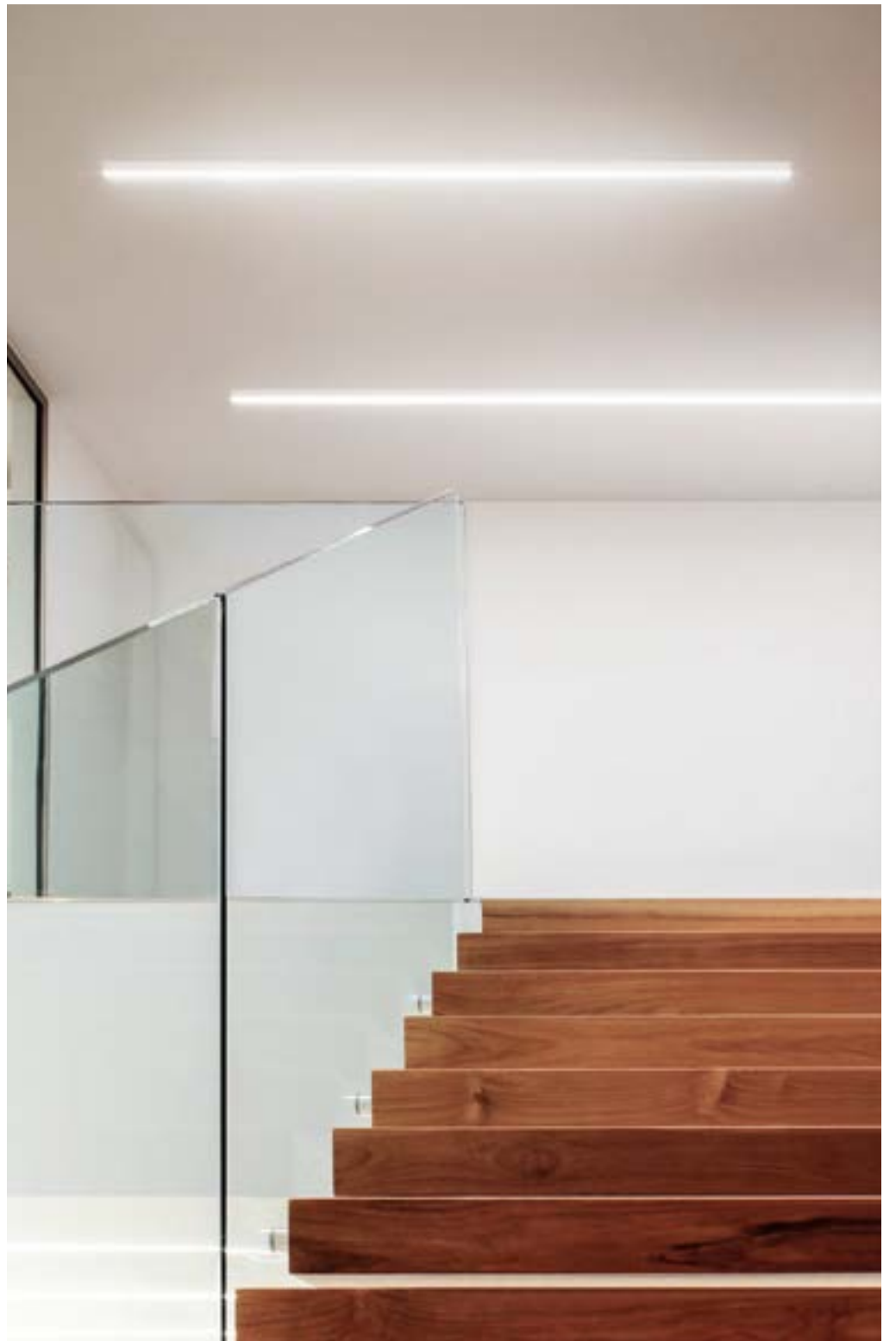



3010 - Profilo multiuso

3010V11	10-63cm 14.4W/mt 1360lm*/mt - 24VDC
3010V21	64-123cm 14.4W/mt 1360lm/mt - 24VDC
3010V31	124-183cm 14.4W/mt 1360lm/mt - 24VDC
3010V41	184-243cm 14.4W/mt 1360lm/mt - 24VDC
3010V51	244-323cm 14.4W/mt 1360lm/mt - 24VDC
3010V61	324-383cm 14.4W/mt 1360lm/mt - 24VDC



3010B1	384-500cm 14.4W/mt 1360lm/mt - 24VDC
--------	--------------------------------------

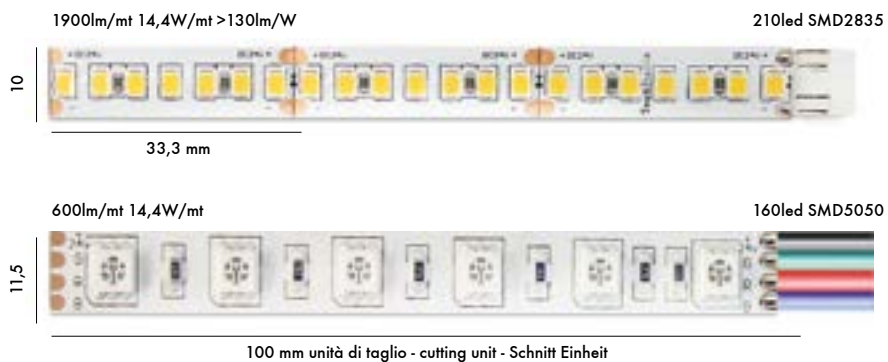

E2 Opale - Opal

● A 2700K

● B 3000K

○ C 4000K

● E RGB



 Alimentatore non incluso - Power Supply not included - Netzteil nicht inbegriffen

 Alimentatore Incluso remoto - Included Power Supply in remote - Fernspeisung enthalten

Esempio - Example - Beispiel *

1360lm con - with - mit E2



22W/mt

3010V13	10-63cm 22W/mt 1955lm*/mt - 24VDC
3010V23	64-123cm 22W/mt 1955lm/mt - 24VDC
3010V33	124-183cm 22W/mt 1955lm/mt - 24VDC
3010V43	184-243cm 22W/mt 1955lm/mt - 24VDC
3010V53	244-323cm 22W/mt 1955lm/mt - 24VDC
3010V63	324-383cm 22W/mt 1955lm/mt - 24VDC



3010B3	384-500cm 22W/mt 1955lm/mt - 24VDC
---------------	------------------------------------



E2 Opale - Opal

● **A** 2700K ● **B** 3000K ○ **C** 4000K

BV AL
□ □

 Alimentatore non incluso - Power Supply not included - Netzteil nicht inbegriffen

 Alimentatore Incluso remoto - Included Power Supply in remote - Fernspeisung enthalten

Esempio - Example - Beispiel *

1955lm con - with - mit **E2**



3010M - Profilo multiuso

Profilo a plafone medium in alluminio bianco verniciato con possibilità di passaggio del cavo di alimentazione al suo interno. Emissione luminosa diffusa diretta e laterale. Il profilo è fornito tagliato in misura, completo di strip led e con tutti gli accessori per l'installazione (alimentatore escluso).

Medium-sized aluminium ceiling profile, white painted and with a cavity for the cable passage. Diffused down and side light emission. This profile, cut to size, is equipped with led strip and all the accessories for the installation (the power supply is not included).

Mittelgroßes Deckenprofil aus Aluminium, weiß lackiert und mit einem Hohlraum für die Kabeldurchführung. Diffuser Lichtaustritt nach unten und zur Seite. Dieses auf Maß geschnittene Profil ist mit Led-Streifen und dem gesamten Zubehör für die Installation ausgestattet (das Netzteil ist nicht enthalten).

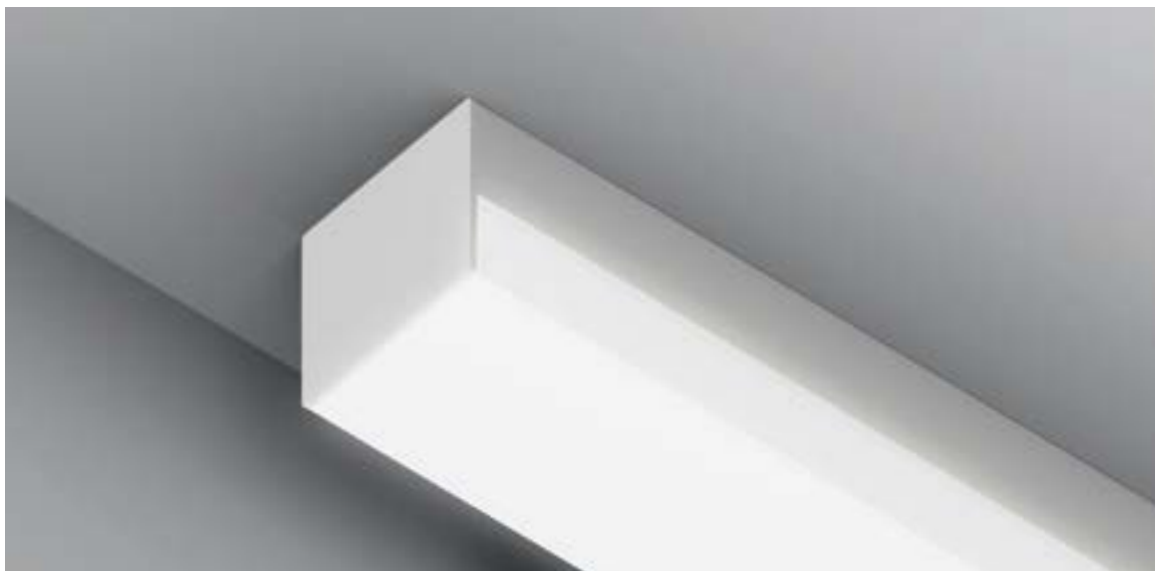
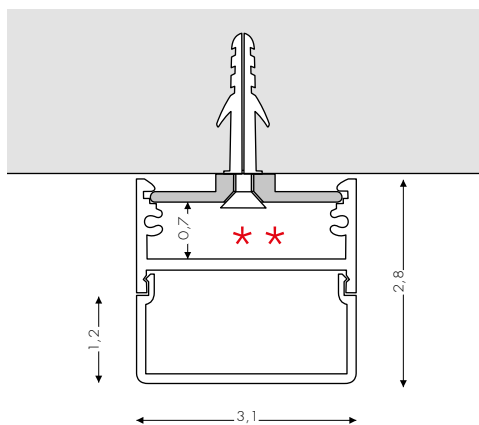

**Possibilità passaggio cavo
Passage for electrical cables
Durchgang für elektrische Kabel







14.4W/mt

3010M - Profilo multiuso

3010MV11	10-63cm 14.4W/mt 1360lm*/mt - 24VDC
3010MV21	64-123cm 14.4W/mt 1360lm/mt - 24VDC
3010MV31	124-183cm 14.4W/mt 1360lm/mt - 24VDC
3010MV41	184-243cm 14.4W/mt 1360lm/mt - 24VDC
3010MV51	244-323cm 14.4W/mt 1360lm/mt - 24VDC
3010MV61	324-383cm 14.4W/mt 1360lm/mt - 24VDC

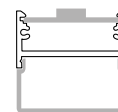

3010MB1 384-500cm 22W/mt 1360lm/mt - 24VDC

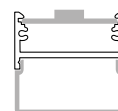

E2 Opale - Opal



A 2700K



B 3000K



C 4000K

BV



 Alimentatore non incluso - Power Supply not included - Netzteil nicht inbegriffen

 Alimentatore Incluso remoto - Included Power Supply in remote - Fernspeisung enthalten

Esempio - Example - Beispiel *

1360lm con - with - mit **E2**



22W/mt

3010MV13	10-63cm 22W/mt 1955lm*/mt - 24VDC
3010MV23	64-123cm 22W/mt 1955lm/mt - 24VDC
3010MV33	124-183cm 22W/mt 1955lm/mt - 24VDC
3010MV43	184-243cm 22W/mt 1955lm/mt - 24VDC
3010MV53	244-323cm 22W/mt 1955lm/mt - 24VDC
3010MV63	324-383cm 22W/mt 1955lm/mt - 24VDC

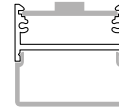

3010MB3	384-500cm 22W/mt 1955lm/mt - 24VDC
---------	------------------------------------

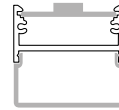

E2 Opale - Opal

A 2700K B 3000K C 4000K



BV

Alimentatore non incluso - Power Supply not included - Netzteil nicht inbegriffen

Alimentatore Incluso remoto - Included Power Supply in remote - Fernspeisung enthalten

Esempio - Example - Beispiel *

1955lm con - with - mit **E2**



40100 - Veletta luminosa

Profilo a plafone in alluminio per realizzare velette luminose a plafone senza necessità di cartongesso.

Il profilo è tagliato in misura, completo di strip led e con tutti gli accessori per l'installazione (alimentatore escluso).

Aluminium ceiling profile designed to create wall washer effects without the need for plasticboard. The line, cut to size, is equipped with the Strip-Led and all the accessories for the installation. (the driver is not included).

Aluminium-Deckenleuchte entworfen, um Wallwasher Effekte zu schaffen, ohne die Notwendigkeit für Gipskartonplatte.

Die Linie, maßgeschneidert, ist mit dem Strip-Led und dem gesamten Zubehör für die Installation ausgestattet. (das Netzteil ist nicht enthalten).

2 testate incluse
2 end caps included
2 Endkappen enthalten

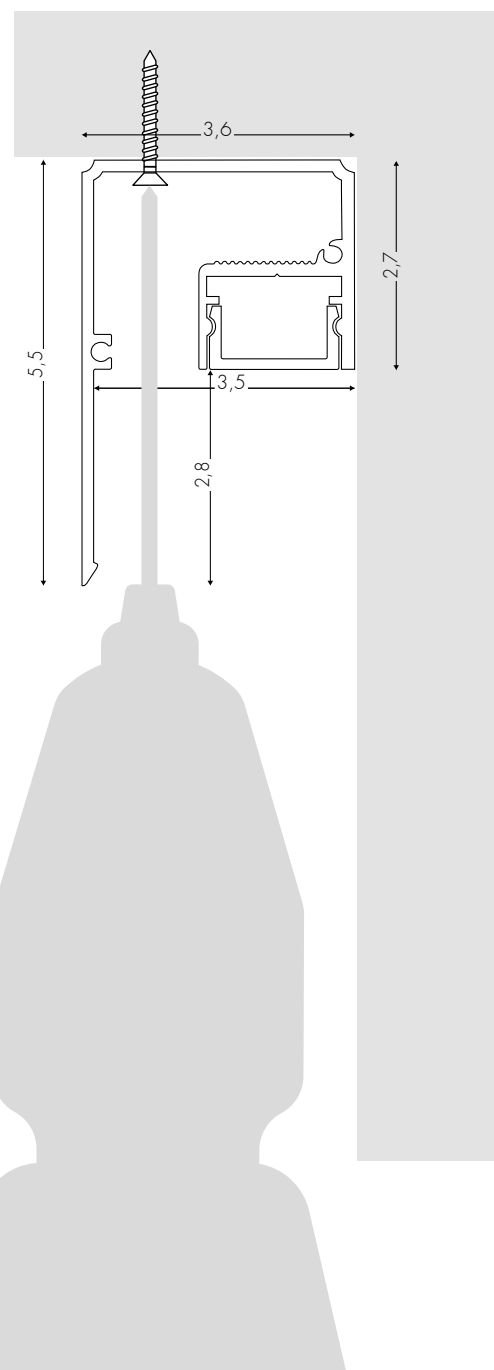





14.4W/mt

40100 - VELETTA LUMINOSA

4010OV11	10-63cm 14.4W/mt 1600lm*/mt - 24VDC
4010OV21	64-123cm 14.4W/mt 1600lm/mt - 24VDC
4010OV31	124-183cm 14.4W/mt 1600lm/mt - 24VDC
4010OV41	184-243cm 14.4W/mt 1600lm/mt - 24VDC
4010OV51	244-323cm 14.4W/mt 1600lm/mt - 24VDC
4010OV61	324-383cm 14.4W/mt 1600lm/mt - 24VDC

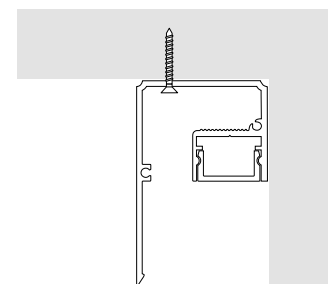

4010OB1	384-500cm 14.4W/mt 1600lm/mt - 24VDC
----------------	--------------------------------------

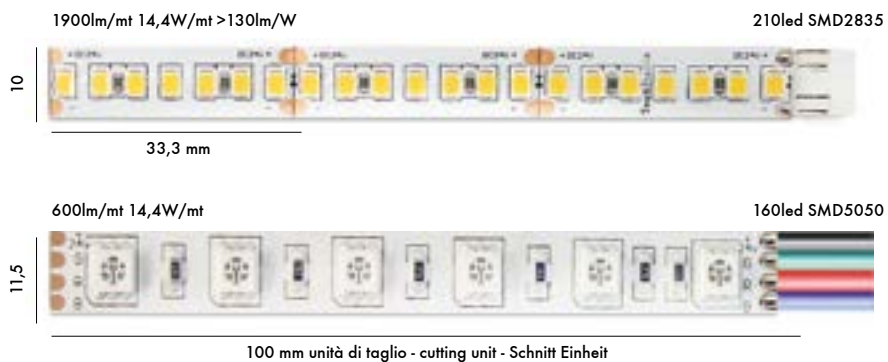
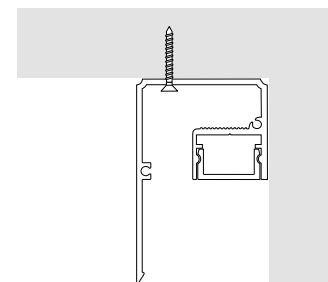

E2 Opale - Opal
 L30 Lente 30° - Lens 30° - Linse 30°
 A 2700K
 B 3000K
 C 4000K
 E RGB

CUSTOM

NE

BV



A Alimentatore non incluso - Power Supply not included - Netzteil nicht inbegriffen

A Alimentatore Incluso remoto - Included Power Supply in remote - Fernspeisung enthalten

Esempio - Example - Beispiel *

1600lm con - with - mit **L30** - 1600lm - 15% con - with - mit **E2**



22W/mt

4010OV13	10-63cm 22W/mt 2300lm*/mt - 24VDC
4010OV23	64-123cm 22W/mt 2300lm/mt - 24VDC
4010OV33	124-183cm 22W/mt 2300lm/mt - 24VDC
4010OV43	184-243cm 22W/mt 2300lm/mt - 24VDC
4010OV53	244-323cm 22W/mt 2300lm/mt - 24VDC
4010OV63	324-383cm 22W/mt 2300lm/mt - 24VDC

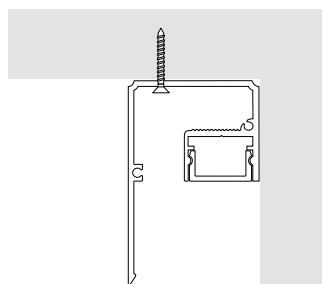

4010OB3	384-500cm 22W/mt 2300lm/mt - 24VDC
---------	------------------------------------

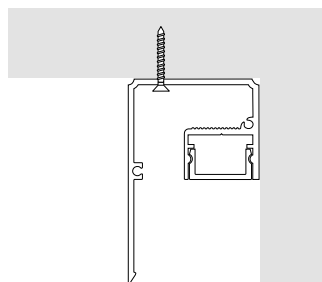

■ E2 Opale - Opal
● L30 lente 30° - Lens 30° - Linse 30°

● A 2700K ● B 3000K ○ C 4000K

CUSTOM

NE

BV

Alimentatore non incluso - Power Supply not included - Netzteil nicht inbegriffen

Alimentatore Incluso remoto - Included Power Supply in remote - Fernspeisung enthalten

Esempio - Example - Beispiel *

2300lm con - with - mit **L30** - 2300lm - 15% con - with - mit **E2**



4010H - Veletta luminosa

Profilo a parete in alluminio per realizzare velette luminose.

Il profilo è fornito tagliato su misura, completo di strip led e con tutti gli accessori per l'installazione (alimentatore escluso).

Aluminium wall profile designed to create wall washer effects.

The line, cut to size, is equipped with the Strip-Led and all the accessories for the installation. (the driver is not included).

Aluminium-Wandleuchte entworfen, um Wallwasher Effekte zu schaffen.

Die Linie, maßgeschneidert, ist mit dem Strip-Led und dem gesamten Zubehör für die Installation ausgestattet. (das Netzteil ist nicht enthalten).

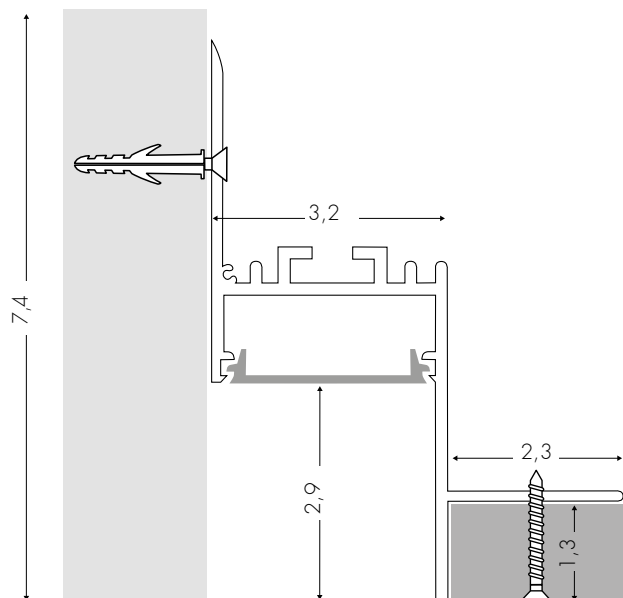





14.4W/mt

4010H - VELETTA LUMINOSA

4010HV11	10-63cm 14.4W/mt 1360lm*/mt - 24VDC
4010HV21	64-123cm 14.4W/mt 1360lm/mt - 24VDC
4010HV31	124-183cm 14.4W/mt 1360lm/mt - 24VDC
4010HV41	184-243cm 14.4W/mt 1360lm/mt - 24VDC
4010HV51	244-323cm 14.4W/mt 1360lm/mt - 24VDC
4010HV61	324-383cm 14.4W/mt 1360lm/mt - 24VDC

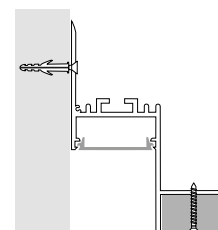

4010HB1	384-500cm 14.4W/mt 1360lm/mt - 24VDC
----------------	--------------------------------------

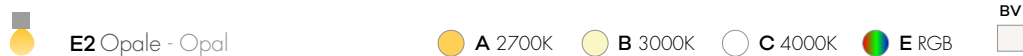
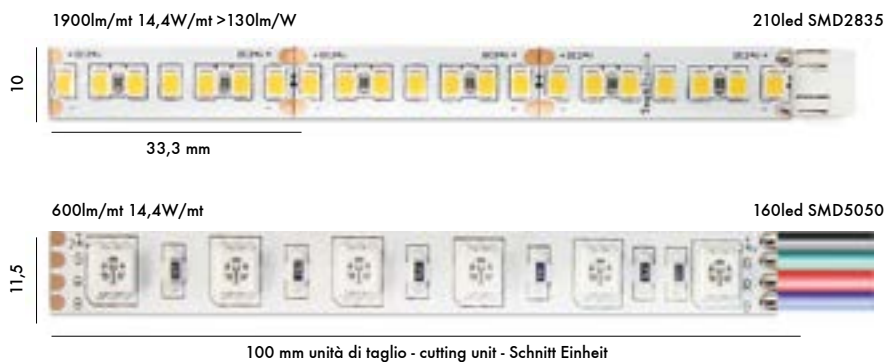
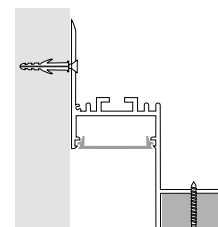

Alimentatore non incluso - Power Supply not included - Netzteil nicht inbegriffen

Alimentatore Incluso remoto - Included Power Supply in remote - Fernspeisung enthalten

Esempio - Example - Beispiel *
1360lm con - with - mit E2

420

indice fotografico

indice famiglia



22W/mt

4010HV13	10-63cm 22W/mt 1955lm*/mt - 24VDC
4010HV23	64-123cm 22W/mt 1955lm/mt - 24VDC
4010HV33	124-183cm 22W/mt 1955lm/mt - 24VDC
4010HV43	184-243cm 22W/mt 1955lm/mt - 24VDC
4010HV53	244-323cm 22W/mt 1955lm/mt - 24VDC
4010HV63	324-383cm 22W/mt 1955lm/mt - 24VDC

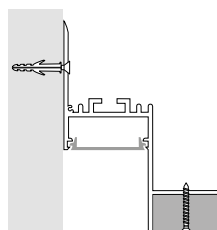

4010HB3	384-500cm 22W/mt 1955lm/mt - 24VDC
---------	------------------------------------

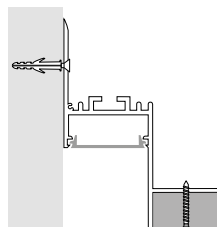

■ E2 Opale - Opal

● A 2700K ● B 3000K ○ C 4000K

■ BV

Alimentatore non incluso - Power Supply not included - Netzteil nicht inbegriffen

Alimentatore Incluso remoto - Included Power Supply in remote - Fernspeisung enthalten

Esempio - Example - Beispiel *

1955lm con - with - mit **E2**



4010 - Incasso con cornice

Profilo ad incasso in alluminio dalle dimensioni contenute per cartongesso. Il profilo è fornito tagliato in misura, completo di strip led e con tutti gli accessori per l'installazione (alimentatore escluso).

Small-sized recessed aluminium profile equipped with outer casing to be installed in the plasterboard. This profile, cut to size, is supplied with the led strip and all the accessories for the installation (the power supply is not included).

Kleinformatisches Aluminium-Einbauprofil mit Außengehäuse zum Einbau in die Gipskartonplatte. Dieses auf Maß geschnittene Profil wird mit dem Led-Streifen und dem gesamten Zubehör für die Installation geliefert (das Netzteil ist nicht enthalten).

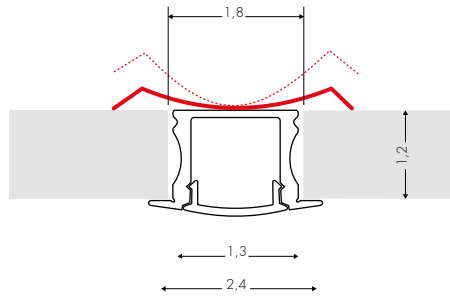





4010 - INCASSO CON CORNICE

4010V11	10-63cm 14.4W/mt 1600lm*/mt - 24VDC
4010V21	64-123cm 14.4W/mt 1600lm/mt - 24VDC
4010V31	124-183cm 14.4W/mt 1600lm/mt - 24VDC
4010V41	184-243cm 14.4W/mt 1600lm/mt - 24VDC
4010V51	244-323cm 14.4W/mt 1600lm/mt - 24VDC
4010V61	324-383cm 14.4W/mt 1600lm/mt - 24VDC

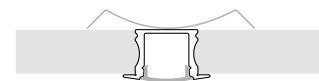

4010B1	384-500cm 14.4W/mt 1600lm/mt - 24VDC
---------------	--------------------------------------



4010VA1	15x15cm 14.4W/mt 1600lm/mt - 24VDC
----------------	------------------------------------

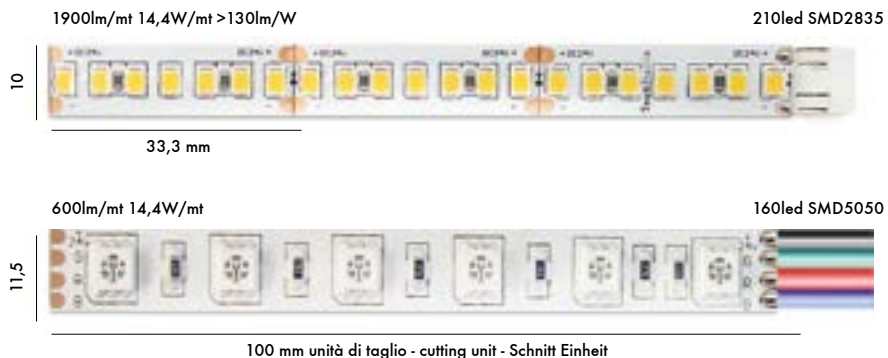
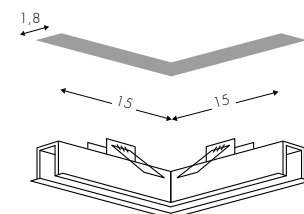

A Alimentatore non incluso - Power Supply not included - Netzteil nicht inbegriffen
A Alimentatore Incluso remoto - Included Power Supply in remote - Fernspeisung enthalten

Esempio - Example - Beispiel *
 1600lm con - with - mit **E28** - 1600lm - 15% con - with - mit **E2**



22W/mt

4010V13	10-63cm 22W/mt 2300lm*/mt - 24VDC
4010V23	64-123cm 22W/mt 2300lm/mt - 24VDC
4010V33	124-183cm 22W/mt 2300lm/mt - 24VDC
4010V43	184-243cm 22W/mt 2300lm/mt - 24VDC
4010V53	244-323cm 22W/mt 2300lm/mt - 24VDC
4010V63	324-383cm 22W/mt 2300lm/mt - 24VDC

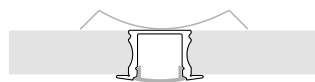

4010B3	384-500cm 22W/mt 2300lm/mt - 24VDC
--------	------------------------------------



4010VA3	15x15cm 22W/mt 2300lm/mt - 24VDC
---------	----------------------------------

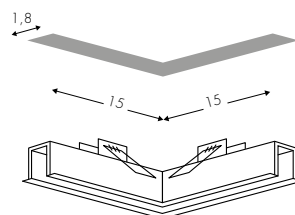

■ E2 Opale - Opal
● E28 Satinato - Frosted - Satiniert

● A 2700K ● B 3000K ○ C 4000K

BV AL
■ ■

Alimentatore non incluso - Power Supply not included - Netzteil nicht inbegriffen

Alimentatore Incluso remoto - Included Power Supply in remote - Fernspeisung enthalten

Esempio - Example - Beispiel *

2300lm con - with - mit **E28** - 2300lm - 1.5% con - with - mit **E2**



4010C - Incasso con cornice

Profilo ad incasso in alluminio dalle dimensioni contenute completo di controcassa per poter essere installato nella muratura. Il profilo è fornito tagliato in misura, completo di strip led e con tutti gli accessori per l'installazione (alimentatore escluso).

Compact dimensions recessed aluminium profile with outer casing to be installed in brick wall. The profile, cut to size, is equipped with the led strip and all the accessories for the installation (the power supply is not included).

Kompaktes Aluminium-Einbauprofil mit Außengehäuse für den Einbau in eine Ziegelwand. Das auf Maß geschnittene Profil ist mit dem Led-Streifen und dem gesamten Zubehör für die Installation ausgestattet (das Netzteil ist nicht enthalten).

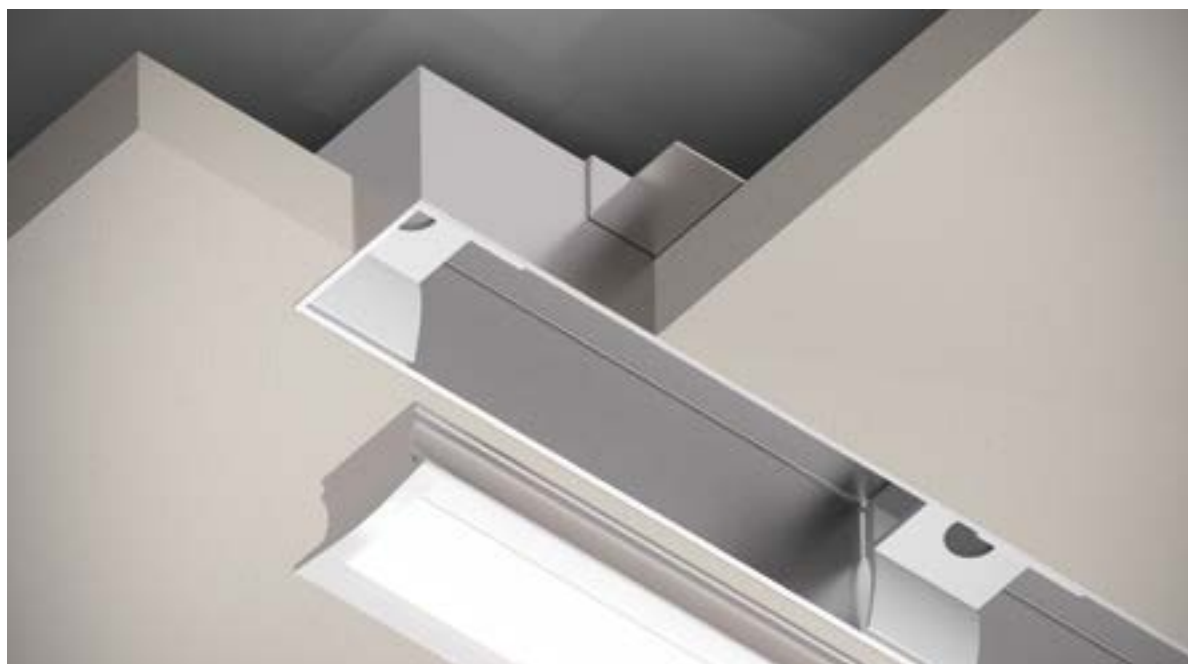
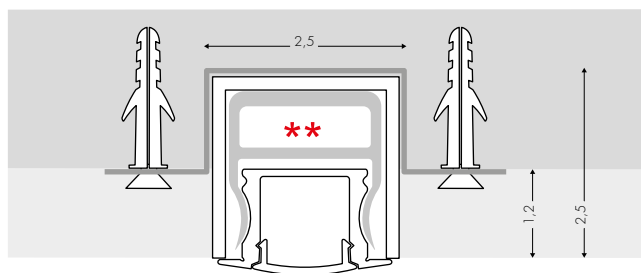

**Possibilità passaggio cavo
Passage for electrical cables
Durchgang für elektrische Kabel





4010C - INCASSO CON
CORNICE

4010CV11	10-63cm 14.4W/mt 1600lm*/mt - 24VDC
4010CV21	64-123cm 14.4W/mt 1600lm/mt - 24VDC
4010CV31	124-183cm 14.4W/mt 1600lm/mt - 24VDC
4010CV41	184-243cm 14.4W/mt 1600lm/mt - 24VDC
4010CV51	244-323cm 14.4W/mt 1600lm/mt - 24VDC
4010CV61	324-383cm 14.4W/mt 1600lm/mt - 24VDC

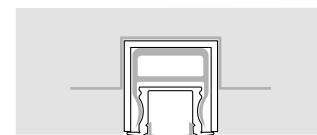

4010CB1	384-500cm 14.4W/mt 1600lm/mt - 24VDC
---------	--------------------------------------

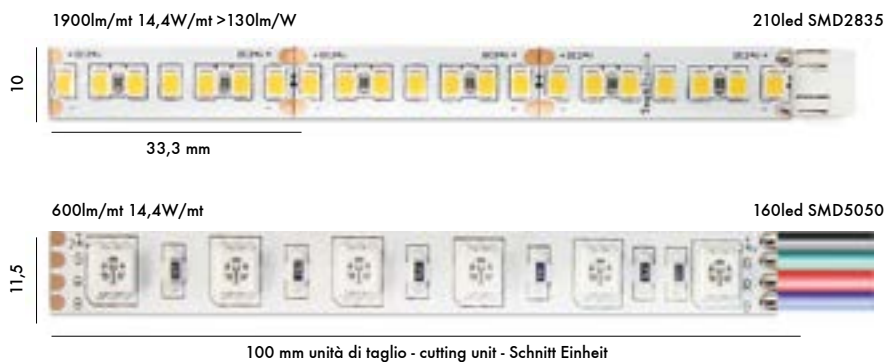
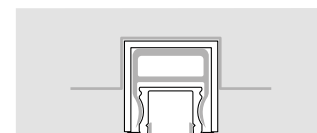

Alimentatore non incluso - Power Supply not included - Netzteil nicht inbegriffen

Alimentatore Incluso remoto - Included Power Supply in remote - Fernspeisung enthalten

Esempio - Example - Beispiel *

1600lm con - with - mit **E28** - 1600lm - 15% con - with - mit **E2**



22W/mt

4010CV13	10-63cm 22W/mt 2300lm*/mt - 24VDC
4010CV23	64-123cm 22W/mt 2300lm/mt - 24VDC
4010CV33	124-183cm 22W/mt 2300lm/mt - 24VDC
4010CV43	184-243cm 22W/mt 2300lm/mt - 24VDC
4010CV53	244-323cm 22W/mt 2300lm/mt - 24VDC
4010CV63	324-383cm 22W/mt 2300lm/mt - 24VDC

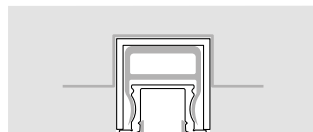

4010CB3	384-500cm 22W/mt 2300lm/mt - 24VDC
----------------	------------------------------------

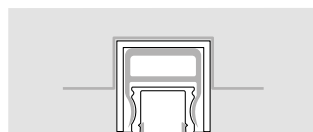

■ E2 Opale - Opal
● E28 Satinato - Frosted - Satiniert ● A 2700K ● B 3000K ○ C 4000K

BV AL
□ □

Alimentatore non incluso - Power Supply not included - Netzteil nicht inbegriffen

Alimentatore Incluso remoto - Included Power Supply in remote - Fernspeisung enthalten

Esempio - Example - Beispiel *

2300lm con - with - mit **E28** - 2300lm - 1.5% con - with - mit **E2**



4010I - Incasso filomuro

Profilo in alluminio ad incasso di spessore perfettamente adattabile alle superfici in cartongesso standard. Disegno ottimizzato per la massima dissipazione termica. Il prodotto è predisposto per la stuccatura e rasatura al fine di ottenere un un effetto filomuro a regola d'arte.

Aluminum profile characterized by a perfectly adaptable thickness to standard plasterboard surfaces. Optimized design for maximum thermal dissipation. The product is prearranged for stuccoing in order to obtain a perfect "flush to the wall" effect.

Eingebautes Aluminiumprofil mit einer Dicke, die sich perfekt an die Standard-Gipskarton Oberflächen anpasst. Optimiertes Design für eine maximale Wärmeableitung. Das Produkt ist für das Stuckieren vorbereitet, um einen perfekten wandbündigen Effekt zu erzielen.

CARTONGESSO
ESCLUSO

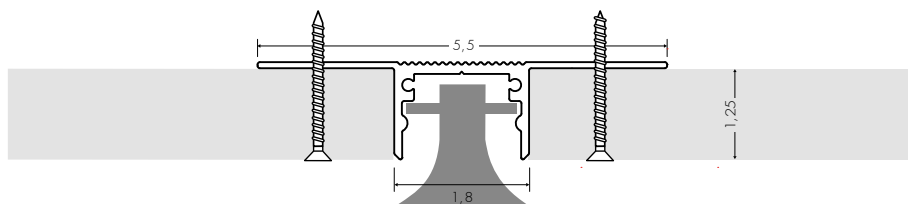

Chiave per l'installazione
Installation key
Installationsschlüssel



Fornito doppio diffusore - Equipped with double diffuser - Mit Doppel-Diffusor ausgestattet

430 indice fotografico indice famiglia







4010I - INCASSO FILOMURO

4010IV41	200-243cm 14.4W/mt 1360lm*/mt - 24VDC
4010IV51	244-323cm 14.4W/mt 1360lm/mt - 24VDC
4010IV61	324-383cm 14.4W/mt 1360lm/mt - 24VDC

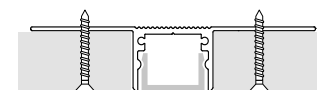

4010IB1	384-500cm 14.4W/mt 1360lm/mt - 24VDC
----------------	--------------------------------------

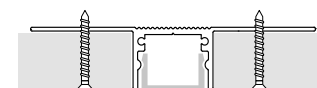

4010IVA1	15x15cm 14.4W/mt 1360lm/mt - 24VDC
-----------------	------------------------------------

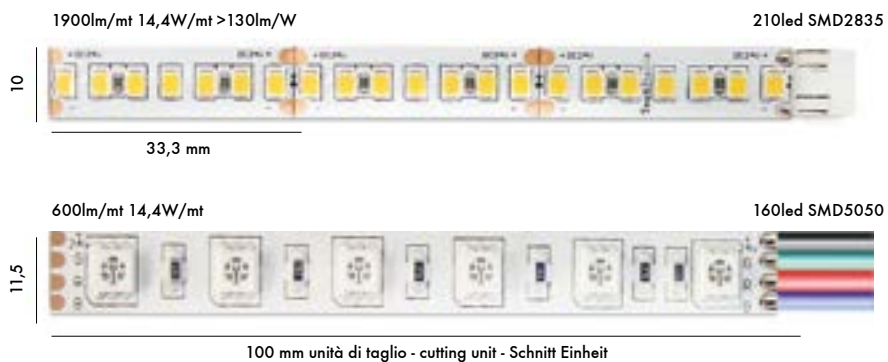
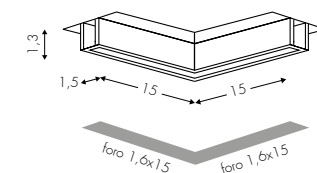

Alimentatore non incluso - Power Supply not included - Netzteil nicht inbegriffen

Alimentatore Incluso remoto - Included Power Supply in remote - Fernspeisung enthalten

Esempio - Example - Beispiel *

1360lm con - with - mit E2



22W/mt

CARTONGESSO
ESCLUSO

4010IV43 200-243cm 22W/mt 1955lm*/mt - 24VDC
4010IV53 244-323cm 22W/mt 1955lm/mt - 24VDC
4010IV63 324-383cm 22W/mt 1955lm/mt - 24VDC

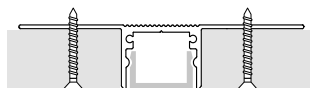

4010IB3 384-500cm 22W/mt 1955lm/mt - 24VDC

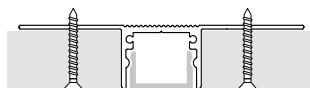

4010IVA3 15x15cm 22W/mt 1955lm/mt - 24VDC

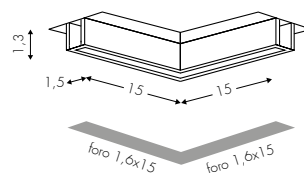

● E2 Opale - Opal

● A 2700K ● B 3000K ○ C 4000K

□ BV

Alimentatore non incluso - Power Supply not included - Netzteil nicht inbegriffen

Alimentatore Incluso remoto - Included Power Supply in remote - Fernspeisung enthalten

Esempio - Example - Beispiel *

1955lm con - with - mit **E2**



4010N - Incasso filomuro

Profilo ad incasso in alluminio dalle dimensioni contenute. Il profilo è fornito tagliato in misura, completo di cartongesso e di strip led e con tutti gli accessori per l'installazione (alimentatore escluso).

Compact dimensions recessed aluminium profile with outer casing. The profile, cut to size, is equipped with the plasterboard and with led strip and all the accessories for the installation (the power supply is not included).

Kompaktes Aluminium-Einbauprofil mit Außengehäuse. Das auf Maß geschnittene Profil ist mit dem Gipskartonplatten und Led-Streifen und dem gesamten Zubehör für die Installation ausgestattet (das Netzteil ist nicht enthalten).

CARTONGESSO
INCLUSO

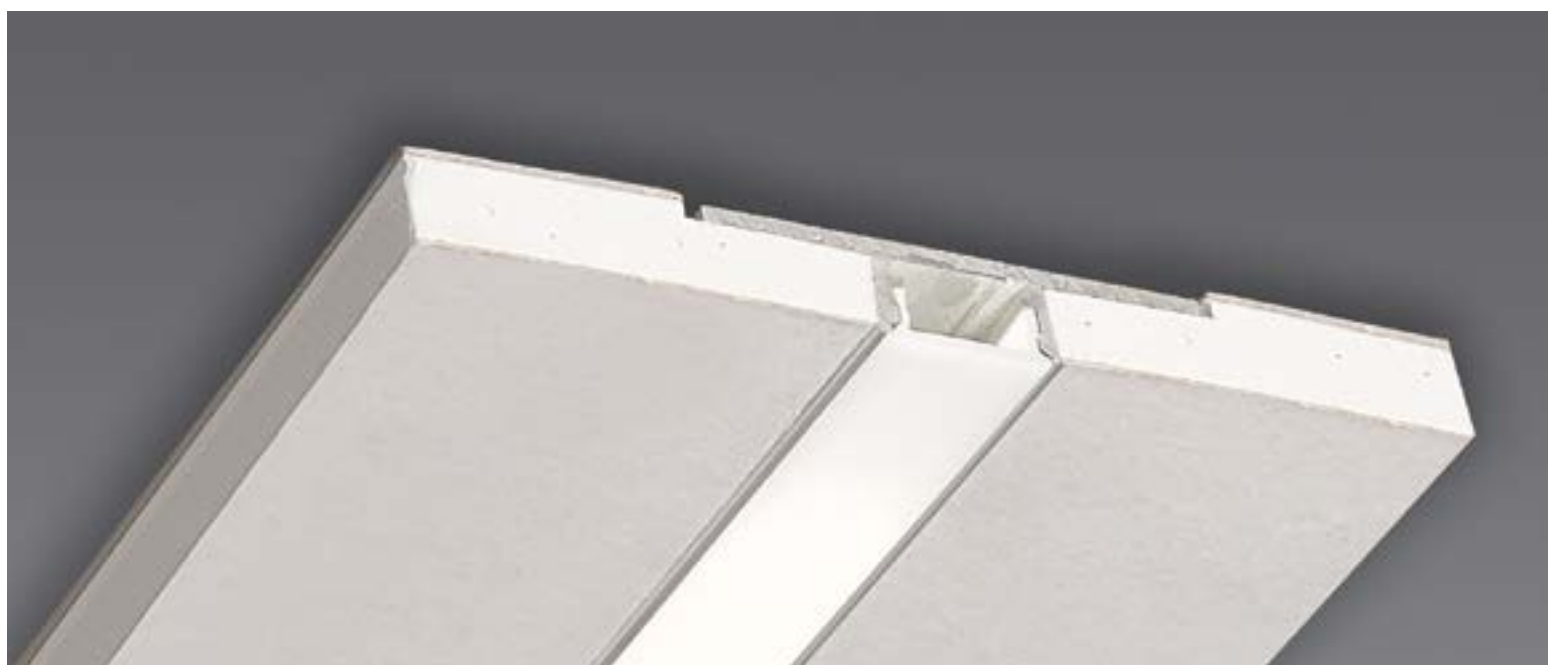
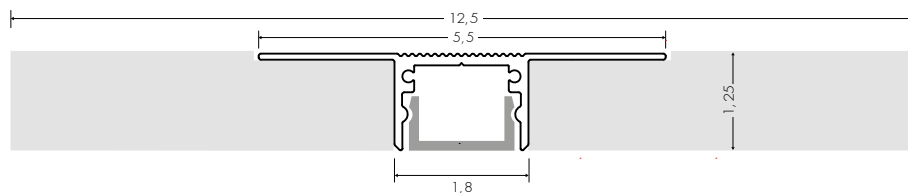

Fornito doppio diffusore - Equipped with double diffuser - Mit Doppel-Diffusor ausgestattet







4010N - INCASSO FILOMURO

4010NV41 200cm 14.4W/mt 1360lm*/mt - 24VDC

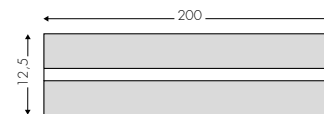

4010NVA41 24x24cm 14.4W/mt 1360lm/mt - 24VDC

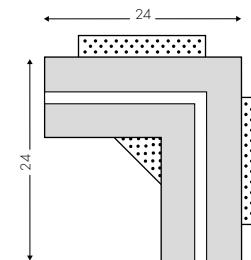

4010NVT41 36x24cm 14.4W/mt 1360lm/mt - 24VDC

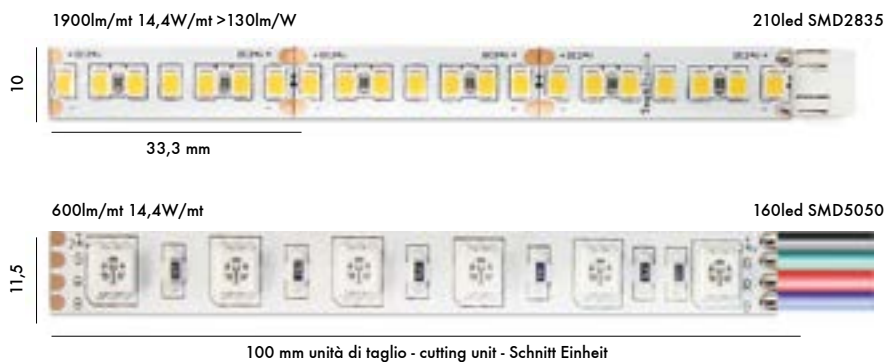
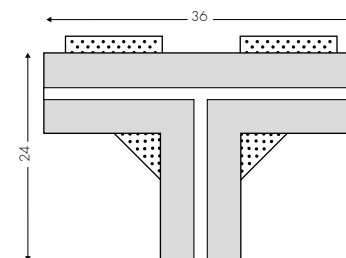

A Alimentatore non incluso - Power Supply not included - Netzteil nicht inbegriffen

Esempio - Example - Beispiel *
1360lm con - with - mit **E2**



22W/mt

CARTONGESSO
INCLUSO

4010NV43 200cm 22W/mt 1955lm*/mt - 24VDC

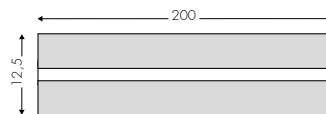

4010NVA43 24x24cm 22W/mt 1955lm/mt - 24VDC

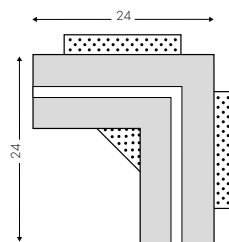

4010NVT43 36x24cm 22W/mt 1955lm/mt - 24VDC

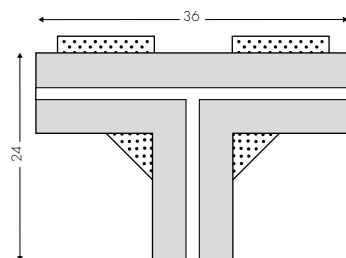

E2 Opale - Opal



A 2700K



B 3000K



C 4000K

BV



 Alimentatore non incluso - Power Supply not included - Netzteil nicht inbegriffen

Esempio - Example - Beispiel *
1955lm con - with - mit **E2**



4010M - Incasso con cornice

Profilo in alluminio ad incasso di spessore perfettamente adattabile alle superfici in cartongesso standard. Disegno ottimizzato per la massima dissipazione termica.

Aluminum profile characterized by a perfectly adaptable thickness to standard plasterboard surfaces. Optimized design for maximum thermal dissipation.

Eingebautes Aluminiumprofil mit einer Dicke, die sich perfekt an die Standard-Gipskarton Oberflächen anpasst. Optimiertes Design für eine maximale Wärmeableitung.

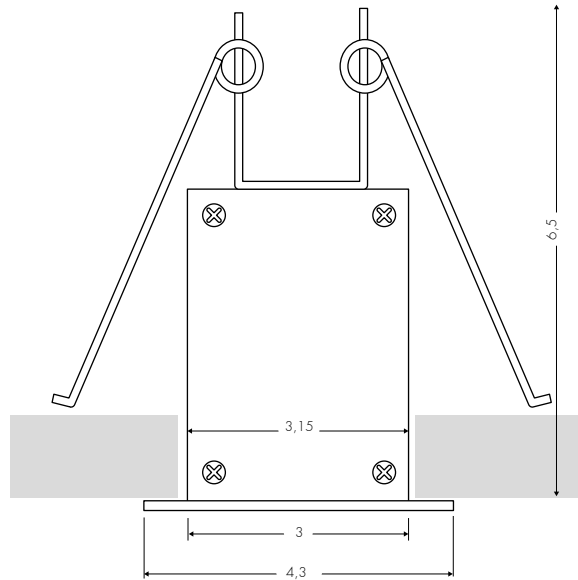



Incluso - Included - Einbezogen

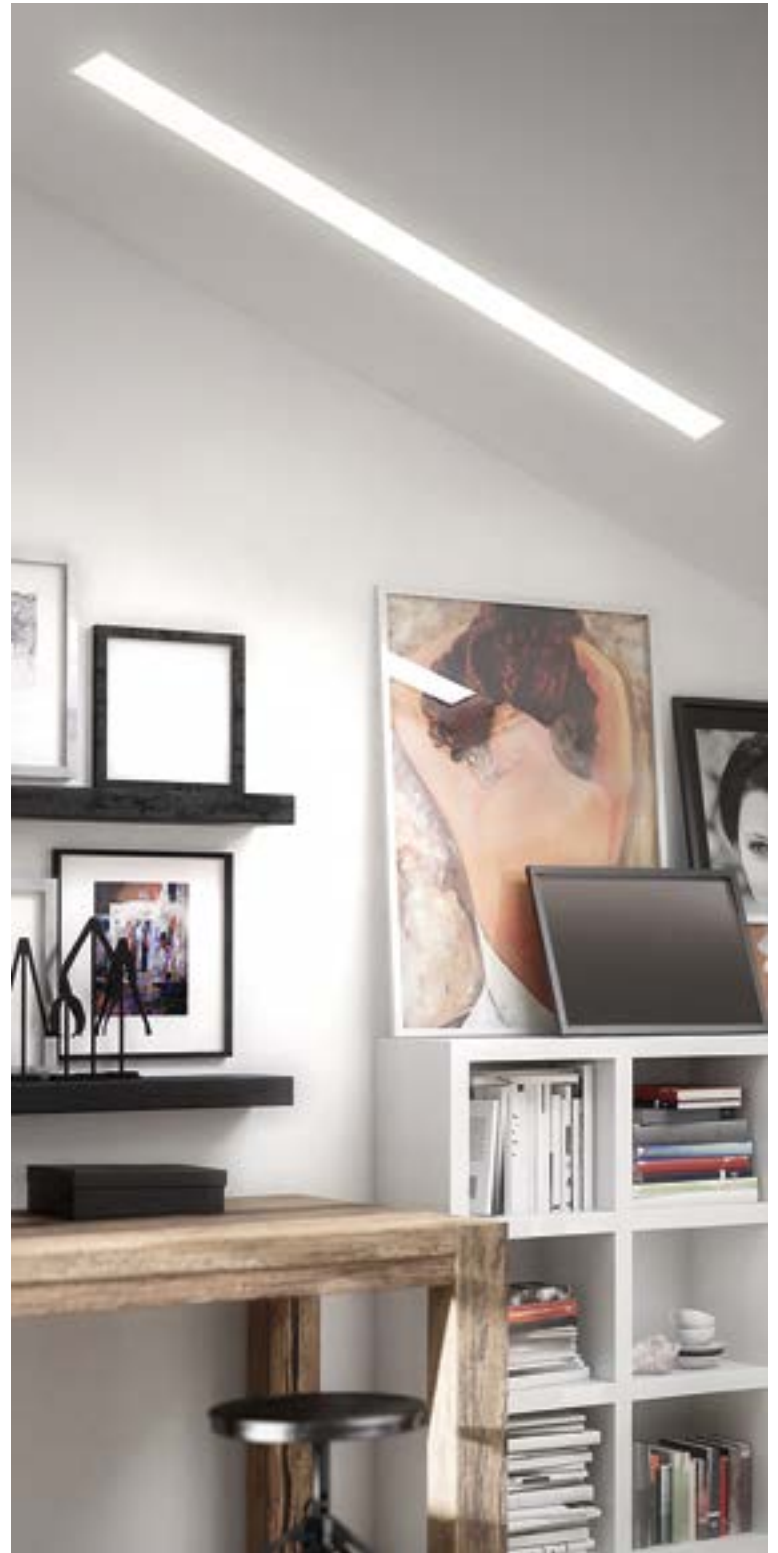



14.4W/mt

4010M - INCASSO CON CORNICE

4010MV11	10-63cm 14.4W/mt 1600lm*/mt - 24VDC
4010MV21	64-123cm 14.4W/mt 1600lm/mt - 24VDC
4010MV31	124-183cm 14.4W/mt 1600lm/mt - 24VDC
4010MV41	184-243cm 14.4W/mt 1600lm/mt - 24VDC
4010MV51	244-323cm 14.4W/mt 1600lm/mt - 24VDC
4010MV61	324-383cm 14.4W/mt 1600lm/mt - 24VDC

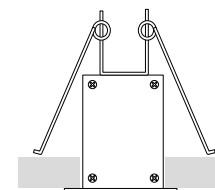

4010MB1	384-500cm 14.4W/mt 1600lm/mt - 24VDC
----------------	--------------------------------------

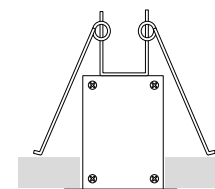

4010MVA1	15x15cm 14.4W/mt 1600lm/mt - 24VDC
-----------------	------------------------------------

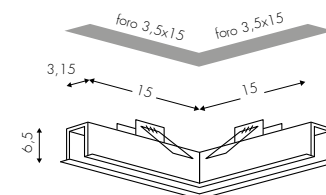

1900lm/mt 14,4W/mt >130lm/W

210led SMD2835



600lm/mt 14,4W/mt

160led SMD5050



100 mm unità di taglio - cutting unit - Schnitt Einheit

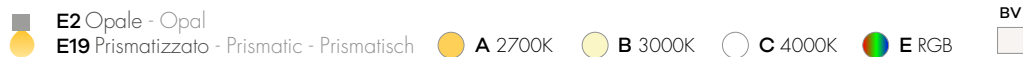

A Alimentatore non incluso - Power Supply not included - Netzteil nicht inbegriffen

A↑ Alimentatore Incluso remoto - Included Power Supply in remote - Einbezogen Netzteil

Esempio - Example - Beispiel *

1600lm con - with - mit **E19** - 1600lm - 15% con - with - **E2**



22W/mt

4010MV13	10-63cm 22W/mt 2300lm*/mt - 24VDC
4010MV23	64-123cm 22W/mt 2300lm/mt - 24VDC
4010MV33	124-183cm 22W/mt 2300lm/mt - 24VDC
4010MV43	184-243cm 22W/mt 2300lm/mt - 24VDC
4010MV53	244-323cm 22W/mt 2300lm/mt - 24VDC
4010MV63	324-383cm 22W/mt 2300lm/mt - 24VDC

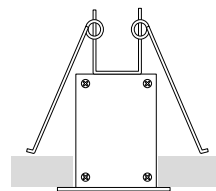

4010MB3	384-500cm 22W/mt 2300lm/mt - 24VDC
---------	------------------------------------

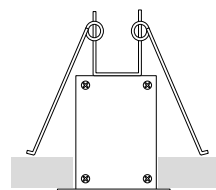

4010MVA3	15x15cm 22W/mt 2300lm/mt - 24VDC
----------	----------------------------------

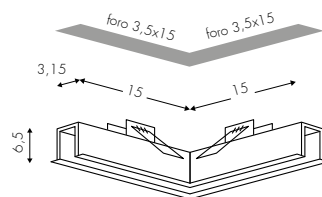

■ E2 Opale - Opal
● E19 Prismatic - Prismatic - Prismatisch

● A 2700K ● B 3000K ○ C 4000K

BV
□

Alimentatore non incluso - Power Supply not included - Netzteil nicht inbegriffen

Alimentatore Incluso remoto - Included Power Supply in remote - Einbezogenes Netzteil

Esempio - Example - Beispiel *

2300lm con - with - mit E19 - 2300lm - 1.5% con - with - E2



4010F - Incasso filomuro

Profilo in alluminio ad incasso di spessore perfettamente adattabile alle superfici in cartongesso standard e superfici in muratura. Disegno ottimizzato per la massima dissipazione termica. Il prodotto è predisposto per la stuccatura e rasatura al fine di ottenere un un effetto filomuro a regola d'arte.

Aluminum profile characterized by a perfectly adaptable thickness to standard plasterboard and brick wall surfaces. Optimized design for maximum thermal dissipation. The product is prearranged for stuccoing in order to obtain a perfect "flush to the wall" effect.

Eingebautes Aluminiumprofil mit einer Dicke, die sich perfekt an die Standard-Gipskarton und Mauer Oberflächen anpasst. Optimiertes Design für eine maximale Wärmeableitung. Das Produkt ist für das Stuckieren vorbereitet, um einen perfekten wandbündigen Effekt zu erzielen.

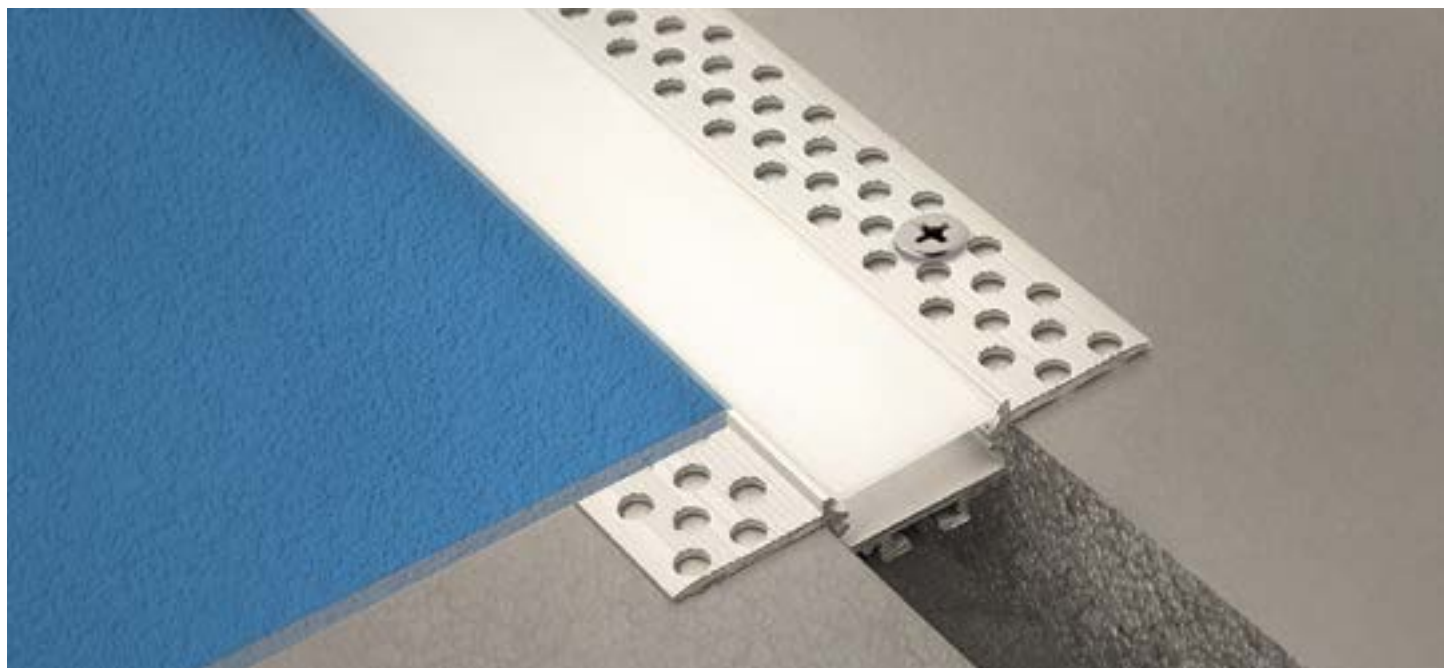
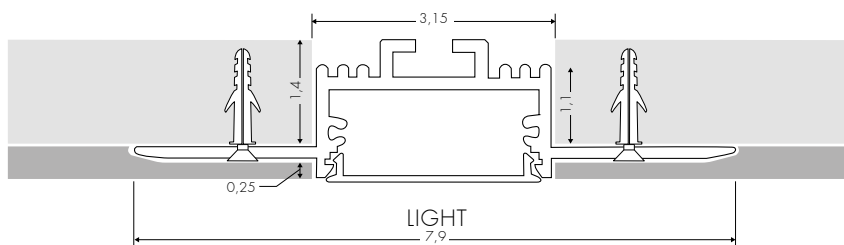

Fornito doppio diffusore - Equipped with double diffuser - Mit Doppel-Diffusor ausgestattet





Incluso - Included - Einbezogen





4010F - INCASSO FILOMURO

4010FV15	10-63cm 14.4W/mt 1360lm*/mt - 24VDC
4010FV25	64-123cm 14.4W/mt 1360lm/mt - 24VDC
4010FV35	124-183cm 14.4W/mt 1360lm/mt - 24VDC
4010FV45	184-243cm 14.4W/mt 1360lm/mt - 24VDC
4010FV55	244-323cm 14.4W/mt 1360lm/mt - 24VDC
4010FV65	324-383cm 14.4W/mt 1360lm/mt - 24VDC

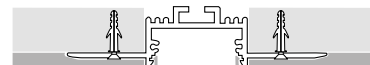

4010FB5	384-500cm 14.4W/mt 1360lm/mt - 24VDC
----------------	--------------------------------------

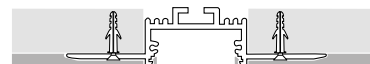

4010FVA5	15x15cm 14.4W/mt 1360lm/mt - 24VDC
-----------------	------------------------------------

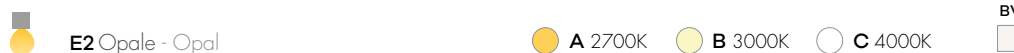
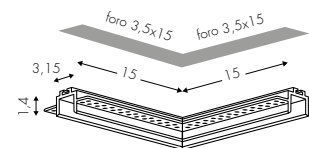

A Alimentatore non incluso - Power Supply not included - Netzteil nicht inbegriffen
A↑ Alimentatore Incluso remoto - Included Power Supply in remote - Fernspeisung enthalten

Esempio - Example - Beispiel *
 1360lm con - with - mit **E2**



22W/mt IP65

4010FV16	10-63cm 22W/mt 2300lm*/mt - 24VDC
4010FV26	64-123cm 22W/mt 2300lm/mt - 24VDC
4010FV36	124-183cm 22W/mt 2300lm/mt - 24VDC
4010FV46	184-243cm 22W/mt 2300lm/mt - 24VDC
4010FV56	244-323cm 22W/mt 2300lm/mt - 24VDC
4010FV66	324-383cm 22W/mt 2300lm/mt - 24VDC

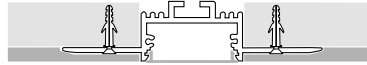

4010FB6	384-500cm 22W/mt 2300lm/mt - 24VDC
---------	------------------------------------

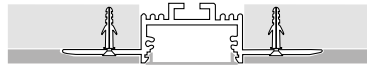

4010FVA6	15x15cm 22W/mt 2300lm/mt - 24VDC
----------	----------------------------------

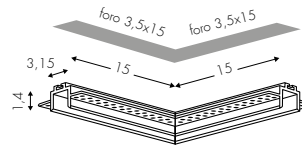

■ E2 Opale - Opal

● A 2700K ● B 3000K ○ C 4000K

■ BV

Alimentatore non incluso - Power Supply not included - Netzteil nicht inbegriffen

Alimentatore Incluso remoto - Included Power Supply in remote - Fernspeisung enthalten

Esempio - Example - Beispiel *
2300lm con - with - mit **E2**



4010L - Incasso con cornice

Profilo ad incasso large in alluminio per cartongesso. Il profilo è fornito tagliato in misura, completo di strip led e con tutti gli accessori per l'installazione (alimentatore escluso).

Large dimension recessed aluminium profile for plasterboard. The profile, cut to size, is equipped with the led strip and all the accessories for installation (the power supply is not included).

Groß dimensioniertes Aluminium-Einbauprofil für Gipskartonplatten. Das auf Maß geschnittene Profil ist mit dem Led-Streifen und dem gesamten Zubehör für die Installation ausgestattet (das Netzteil ist nicht enthalten).

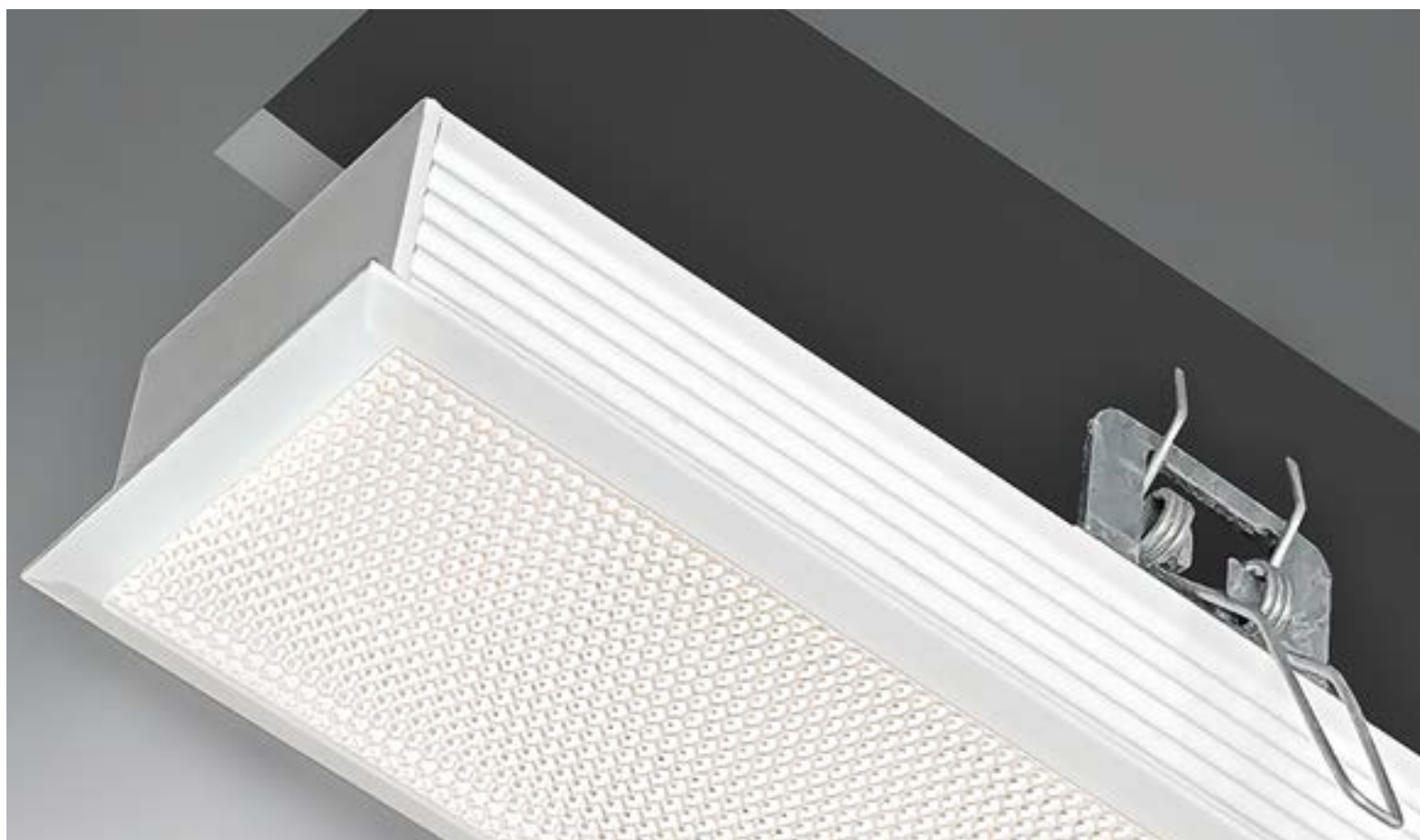
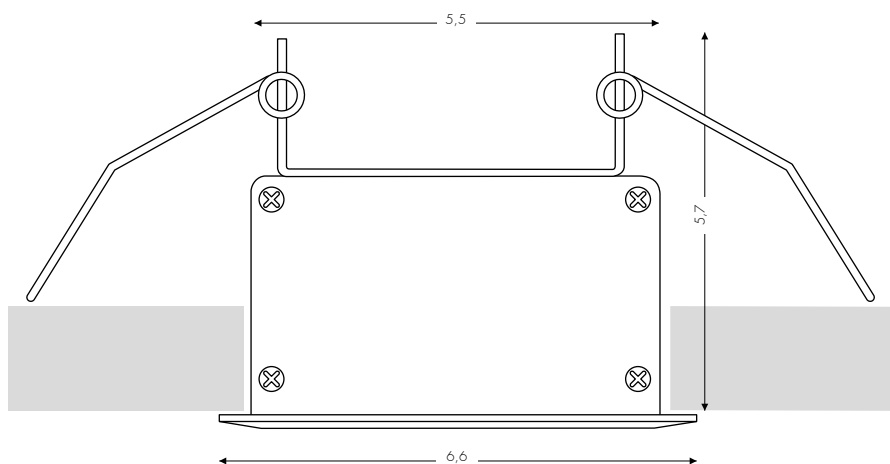





4010L - INCASSO CON CORNICE

4010LV11	10-63cm 14.4W/mt 1600lm*/mt - 24VDC
4010LV21	64-123cm 14.4W/mt 1600lm/mt - 24VDC
4010LV31	124-183cm 14.4W/mt 1600lm/mt - 24VDC
4010LV41	184-243cm 14.4W/mt 1600lm/mt - 24VDC
4010LV51	244-323cm 14.4W/mt 1600lm/mt - 24VDC
4010LV61	324-383cm 14.4W/mt 1600lm/mt - 24VDC

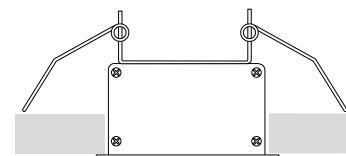

4010LB1	384-500cm 14.4W/mt 1600lm/mt - 24VDC
----------------	--------------------------------------

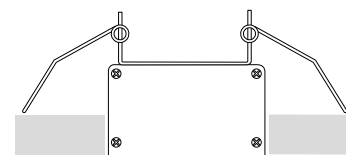

4010LVA1	15x15cm 14.4W/mt 1600lm/mt - 24VDC
-----------------	------------------------------------

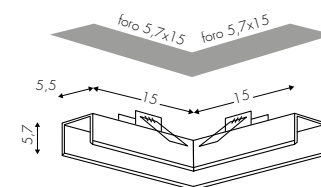

1900lm/mt 14,4W/mt >130lm/W

210led SMD2835



600lm/mt 14,4W/mt

160led SMD5050



100 mm unità di taglio - cutting unit - Schnitt Einheit

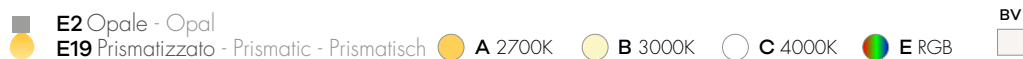

A Alimentatore non incluso - Power Supply not included - Netzteil nicht inbegriffen

A Alimentatore Incluso remoto - Included Power Supply in remote - Fernspeisung enthalten

Esempio - Example - Beispiel *

1600lm con - with - mit **E19** - 1600lm - 15% con - with - mit **E2**



22W/mt

4010LV13	10-63cm 22W/mt 2300lm*/mt - 24VDC
4010LV23	64-123cm 22W/mt 2300lm/mt - 24VDC
4010LV33	124-183cm 22W/mt 2300lm/mt - 24VDC
4010LV43	184-243cm 22W/mt 2300lm/mt - 24VDC
4010LV53	244-323cm 22W/mt 2300lm/mt - 24VDC
4010LV63	324-383cm 22W/mt 2300lm/mt - 24VDC

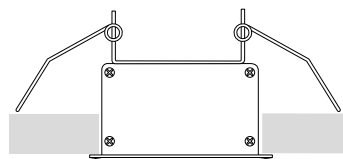

4010LB3	384-500cm 22W/mt 2300lm/mt - 24VDC
---------	------------------------------------

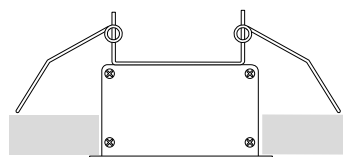

4010LVA3	15x15cm 22W/mt 2300lm/mt - 24VDC
----------	----------------------------------

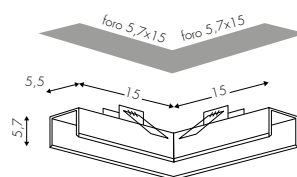

 Alimentatore non incluso - Power Supply not included - Netzteil nicht inbegriffen

 Alimentatore Incluso remoto - Included Power Supply in remote - Fernspeisung enthalten

Esempio - Example - Beispiel *

2300lm con - with - mit **E19** - 2300lm - 15% con - with - mit **E2**



 
MADE in ITALY

450

Sistema di gestione digitale ad incasso in scatola 503 composto da dispositivi di controllo semplici ed immediati, dal look volutamente analogico, progettati per garantire a qualunque utente un'interazione intuitiva e soddisfacente con l'impianto di illuminazione dinamica.

Digital management system built in a 503 electric box and composed by simple control devices. The intentional analogic look is designed to provide to any user an intuitive and satisfying interaction with the dynamic lighting system.

Digitale Management System in einer 503 Box eingebaut und besteht aus einfachen Steuergeräten. Das Analogaussehen wurde entwickelt, um eine intuitive Interaktion mit der dynamischen Lichtanlage zu bieten.



MANAGEMENT SYSTEM

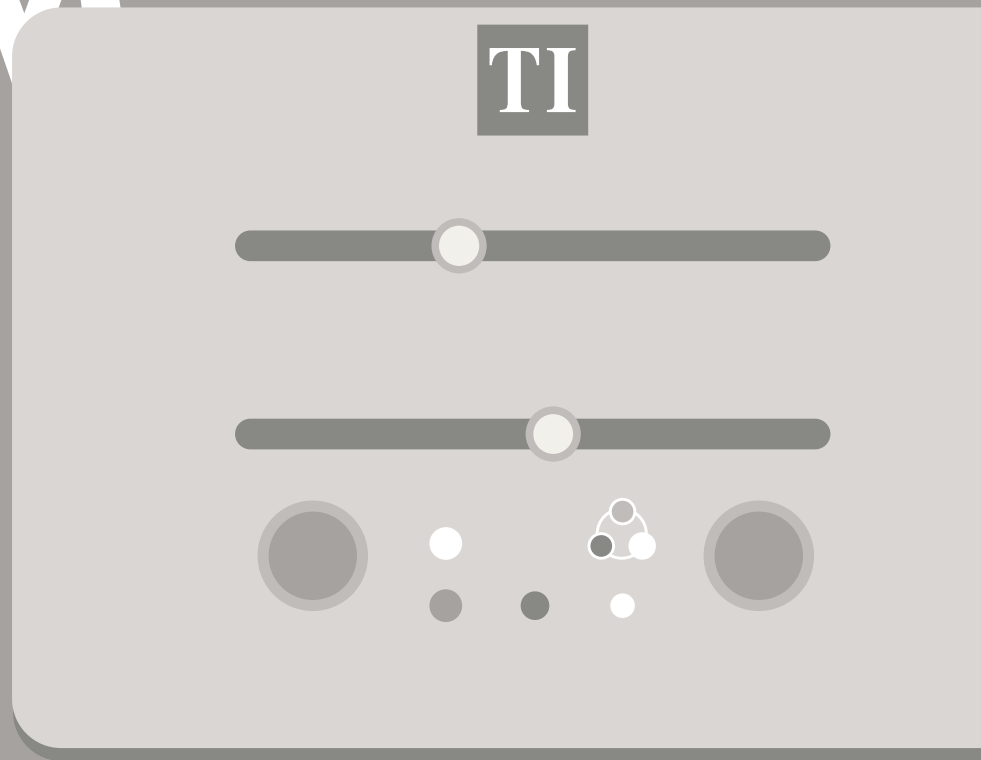



9010MD2ch

Dimmerazione di 2 canali
Two channel dimming
Zwei Kanäle Dimmer



Dispositivi necessari - Necessary devices - Notwendige Geräte

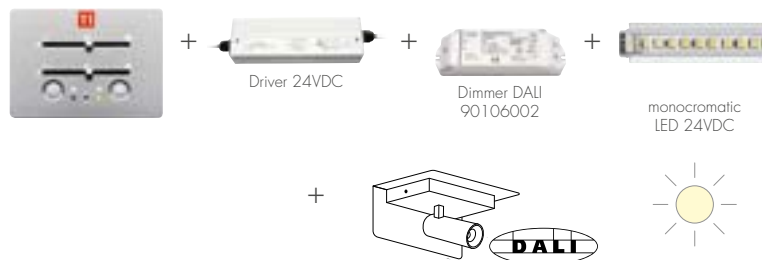

Per scatola 503
Integrated in a 503 electric box
Für 503 Gehäuse

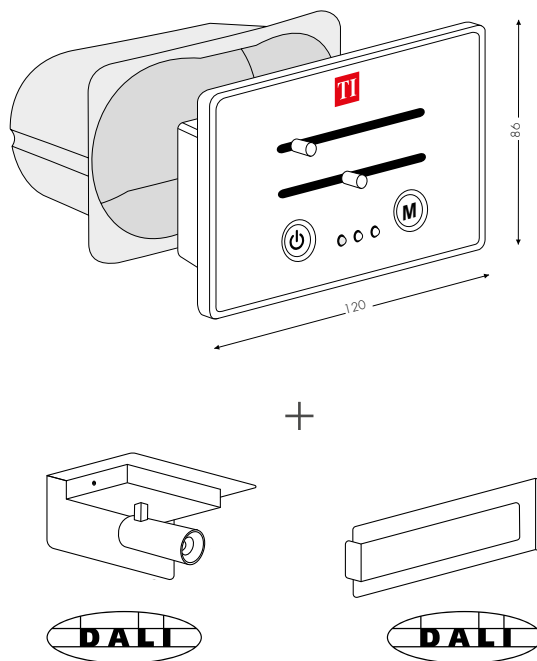

Compatibile con prodotti Dimmer DALI (DM)/Compatible with Dimmer DALI (DM) products / Kompatibel mit DALI Dimmer Produkten







9010CW

Dispositivo per la gestione di sorgenti LED a luce calda/fredda.
Twin-white LED light control device.
Gerät für die Verwaltung von LED Lichtquellen zum warm bis kalt.



Dispositivi necessari - Necessary devices - Notwendige Geräte

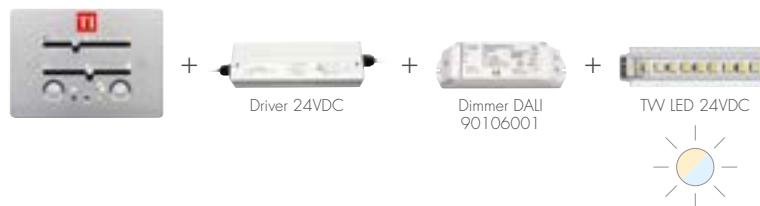

9010RGB

Dispositivo per la gestione di sorgenti LED a luce RGB.
RGB LED light control device.
RGB Lichtsteuergerät.



Dispositivi necessari - Necessary devices - Notwendige Geräte







Il dispositivo coordina le altre centraline e consente di memorizzare fino a 10 scenari luminosi che possono essere facilmente richiamati dall'utilizzatore.

The device coordinates other switchboards and allows to save up to 10 lighting scenes that can be easily recalled by the user.

Das Gerät koordiniert alle Steuergehäuse und ermöglicht bis zu 10 verschiedenen Lichtszenen zu speichern, die der Benutzer auf einfacher Weise einstellen kann.



9010SM

Dispositivo di coordinamento dei sistemi WallLight Control per la creazione di scenari luminosi. Per scatola 503.

WallLight control devices coordinator and scene manager. For 503 electric box.

Gerät, das die Wand-Managementsysteme koordiniert und Lichtszenen erstellt. Für 503 Gehäuse.

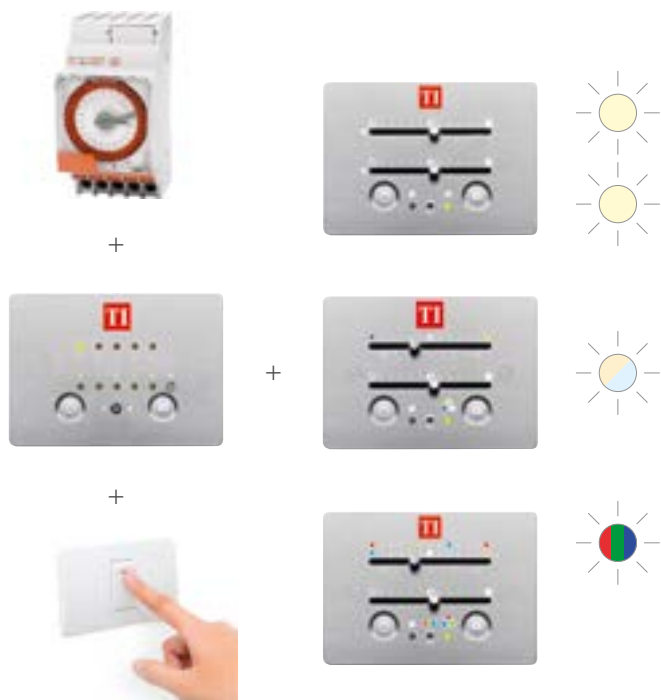



90106002

Dispositivo per la gestione di sorgenti led a luce monocromatica con Pulsante o con sistema Domotico DALI.

Monochromatic led light manager with button or DALI domotic system.

Gerät für die Verwaltung von monochromatischem Led-Lichtquellen mit Druckknopfschaltung oder DALI Domotik.

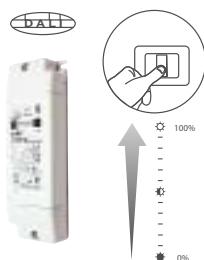

Max 10A 12/24VDC

Dispositivi necessari - Necessary devices - Notwendige Geräte

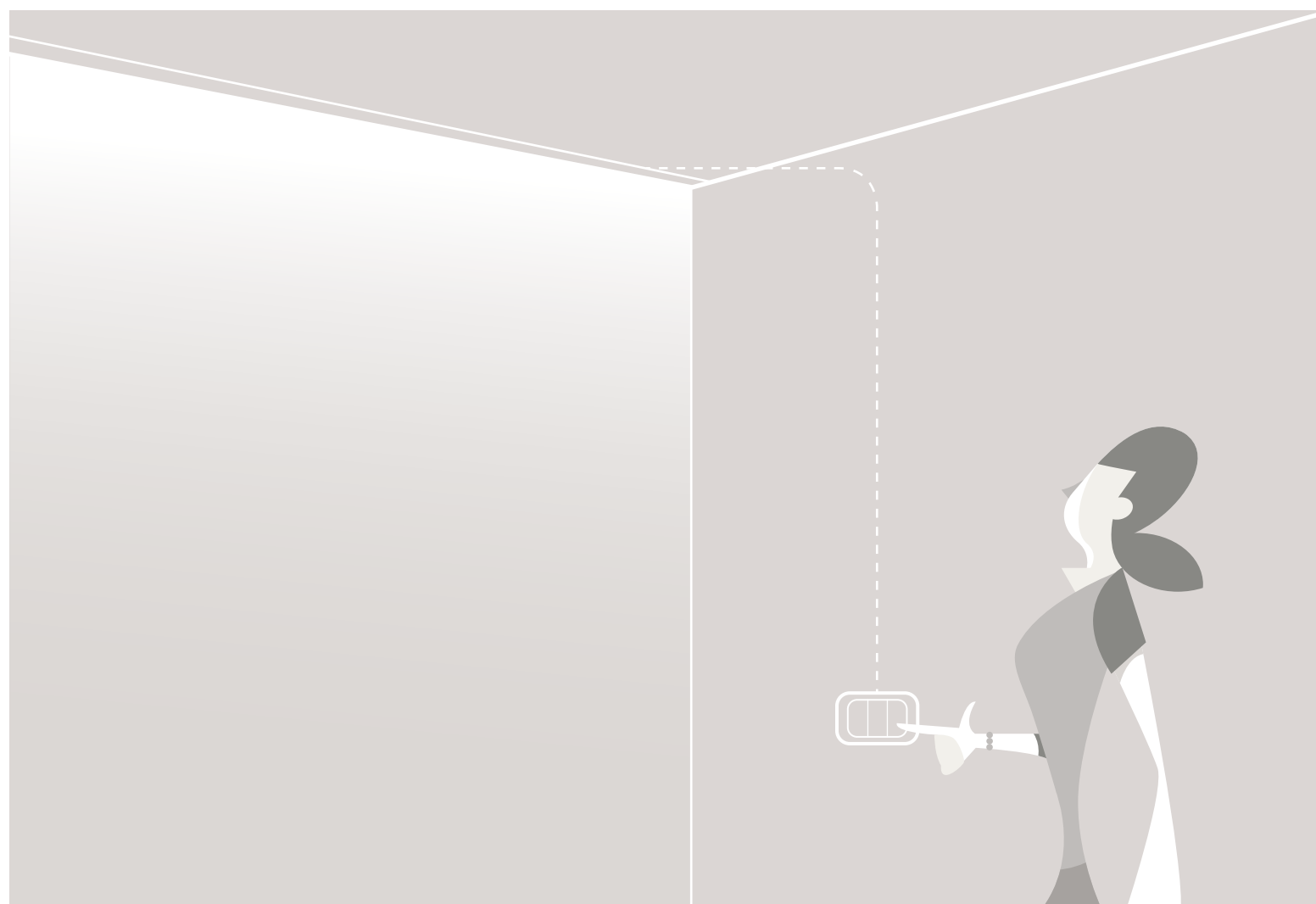

9010BTMD

Dispositivo Bluetooth per rendere dimmerabili Wireless da remoto i nostri prodotti in versione "DM" (DALI).

Our products DM dimmable (DALI) products are compatible with Tridonic module for remote bluetooth dimming.

Bluetooth-Gerät, um unsere "DM" (DALI) Produkte Wireless dimmbar zu machen.





SMART DIM

Famiglia di sistemi di gestione digitali concepiti per impianti con sorgenti Led24VDC di piccole e medie dimensioni. I dispositivi consentono di gestire applicazioni monocromatiche, a luce biodinamica o RGB.

Digital management systems for 24VDC led light sources for small/medium sized installations. These devices can control monochromatic, twin-white or RGB led lights.

Digitale Systeme konzipierten für kleiner und mittlerer Größe Anlagen mit Led24VDC. Die Geräte ermöglichen die Verwaltung der monochromatische, warm und kalt, oder RGB LED-Licht.



L10xW3,5xH1



L9,6xW3,2xH1,8

Inclusi - Included - Inbegriffen

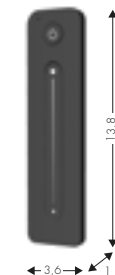

Max 8A
12/24VDC

9010SMARTMD

Dispositivo per la gestione di sorgenti led a luce monocromatica con Radiocomando.

Monochromatic Led light remote control.
Gerät für die Verwaltung von monochromatischem Led-Lichtquellen mit Fernsteuerung.

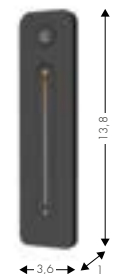

Max 2x5A
12/24VDC

9010SMARTCW

Dispositivo per la gestione di sorgenti led a luce calda/fredda con Radiocomando.

Twin-white Led light remote control.
Gerät für die Verwaltung von Led Quellen zum warm bis kalt Licht mit Fernsteuerung.

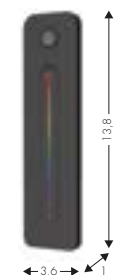

Max 3x4A
12/24VDC

9010SMARTRGB

Dispositivo per la gestione di sorgenti led a luce RGB con Radiocomando.

RGB led light remote control.
Gerät für die Verwaltung von RGB Led-Lichtquellen mit Fernsteuerung.

Dispositivi necessari/Necessary Devices/
Notwendige Geräte

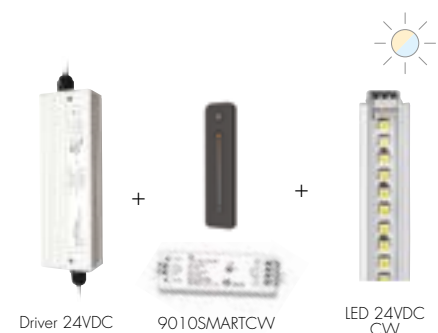
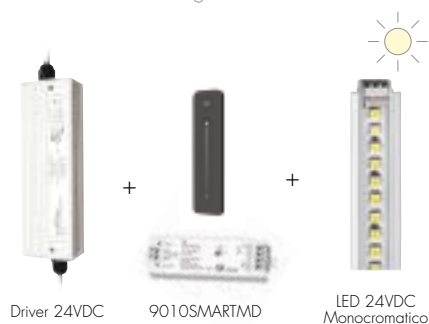



Sistema di scatole porta alimentatore e relativi alimentatori con accessori guidacavi e rosoni per facilitare l'installazione.

Set of boxes designed to organize power supplies and accessories to simplify the wiring and the installation of the lamps.

Set von Gehäusen zur Organisation von Netzteilen und Zubehör, um die Verdrahtung und die Installation der Lampen zu vereinfachen.



DRIVERS & ACCESSORIES





DRIVERS & ACCESSORIES

Sistema di scocche concepite per organizzare alimentatori e sistemi di gestione nascondendoli alla vista e semplificando il cablaggio.

Set of boxes designed to organize power supplies and management systems out of sight and simplifying the wiring.

Aluminiumdosen entwickelt um die Netzteilen und die Lichtmanagementsysteme organisieren und sie, aus den Augen, verstecken und die Verkabelung vereinfachen.

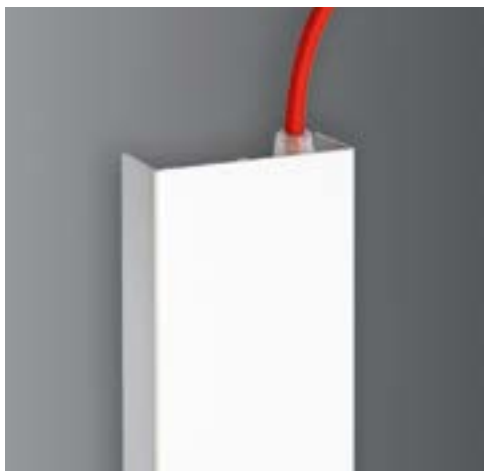

9010XS

Può contenere alimentatore: 30W/75W-24VDC
 It can contains power supply: 30W/75W-24VDC
 Es kann Netzteil enthalteN: 30W/75W-24VDC

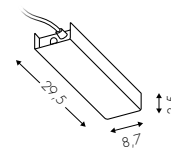

9010M

Può contenere alimentatore: 75W
 100W
 It can contains power supply: 150W
 240W
 Es kann Netzteil enthalten: 240W

75W + 90106002
 100W + 90106002
 150W + 90106002
 240W + 90106002

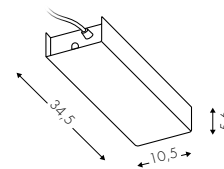

9010L

Può contenere alimentatore: 2x150W - 2x240W
 It can contains power supply: 2x150W - 2x240W
 Es kann Netzteil enthalten: 2x150W - 2x240W

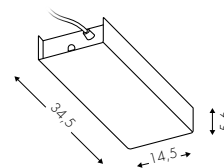

ROSA280

Solo collegamento elettrico rettangolo

Only electrical connection rectangle

Nur elektrische Verbindung Rechteck

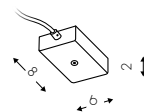

AM003A

Solo collegamento elettrico rotondo

Only electrical connection round

Nur elektrische Verbindung runden





PFC Attivo. Su richiesta IP6X.
Active PFC - On request IP6X.
Aktiv PFC - Auf Anfrage IP6X.

901024030

Alimentatore 30W-24VDC
Power supply 30W-24VDC
Netzteil 30W-24VDC

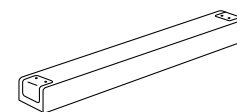

901024075

Alimentatore 75W-24VDC
Power supply 75W-24VDC
Netzteil 75W-24VDC

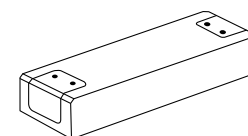

901024100

Alimentatore 100W-24VDC
Power supply 100W-24VDC
Netzteil 100W-24VDC

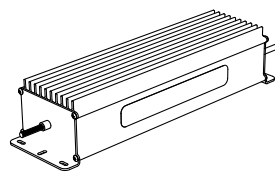

901024150

Alimentatore 150W-24VDC
Power supply 150W-24VDC
Netzteil 150W-24VDC

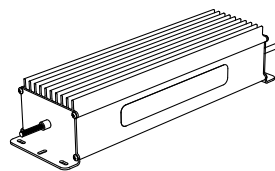

901024240

Alimentatore 240W-24VDC
Power supply 240W-24VDC
Netzteil 240W-24VDC

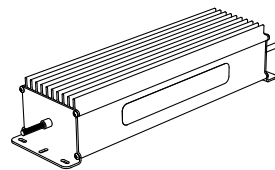

90106002

Dimmer: DALI(Push)/ 1-10V - max 240W-24VDC

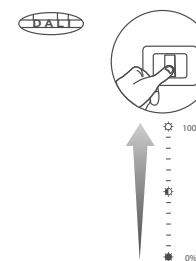
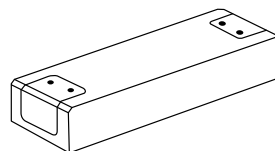



Accessori studiati per facilitare l'installazione. Semplici soluzioni che consentono di guidare e raccogliere i collegamenti e portare la corrente nel punto desiderato.

Accessories designed to simplify the installation. Simple solutions that allow you to guide and collect the connections and bring the current to the desired point.

Zubehör entwickelt um die Montage zu vereinfachen. Einfache Lösungen, mit denen Sie die Verbindungen beurteilen und sammeln und den Strom an den gewünschten Punkt bringen können.

90106014

Guidacavi verticale
Vertical cable guide
Vertikal Kabelführung

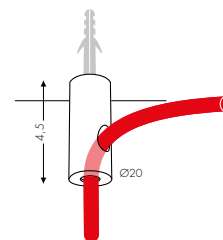

90106015

Guidacavi orizzontale
Horizontal cable guide
Horizontale Kabelführung

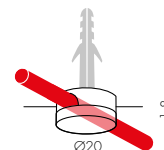

TR





La linea Outdoor veste di luce gli ambienti esterni con soluzioni moderne dal forte impatto estetico. Elementi illuminanti semplici, destinati a durare nel tempo, concepiti per coordinare con la luce interni ed esterni di ambienti residenziali e non.

The Outdoor collection enlightens outdoor environments with modern lighting solutions with a strong aesthetic impact. Simple and timeless lighting elements, designed to embellish with light the interior and exterior of residential and non-residential spaces.

Die Outdoor-Linie beleuchtet Außenbereiche dank moderner Lösungen mit starker ästhetischer Wirkung. Diese einfachen und langlebige Beleuchtungselemente wurden entwickelt, um das Innen- und Außenleben von Wohn- und Nichtwohnräumen zu verschönern.

OUTDOOR







 
MADE in ITALY

472

Esile anello luminoso a luce diffusa la cui forma leggermente socchiusa consente la realizzazione di suggestive composizioni luminose. Disponibile per applicazioni in ambienti umidi interni ed esterni riparati dal sole.

Slight lighting ring with diffused light; its slightly ajar shape allows the creation of suggestive bright compositions. Available for applications in indoor and outdoor wet areas sheltered from the sun.

Dünner Lichtring mit diffusem Licht, dessen leicht halb geschlossene Form die Erzeugung eindrucksvolle helle Kompositionen. Anwendungen für Innen- und vor der Sonne geschützte Außenbereichen sind erhältlich.



A stylized graphic on a teal background. A white curved line starts from the top left and ends at the tip of a 3D arrow pointing to the right. The arrow is light teal with a white outline and a dark teal shadow. The word "LEGGERA" is written in white, bold, uppercase letters across the bottom of the arrow.

LEGGERA



LEGGERA

Prodotto caratterizzato da una struttura leggera in alluminio verniciato a polveri, installabile a sospensione. Sorgente luminosa Led IP54, alimentatore 24VDC escluso.

Suspension lamp characterized by a light weight powder-coated aluminium structure. IP54 Led light source. The 24VDC power supply is not included.

Pendelleuchte, die sich durch eine leichte, pulverbeschichtete Aluminiumstruktur auszeichnet. IP54 LED Lichtquelle. Das 24VDC Netzteil ist nicht enthalten

1032A54

35W 1450lm* - 24VDC

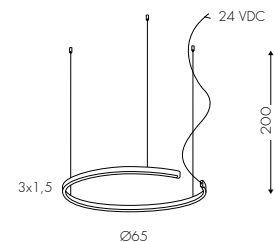

1032B54

48W 2150lm - 24VDC

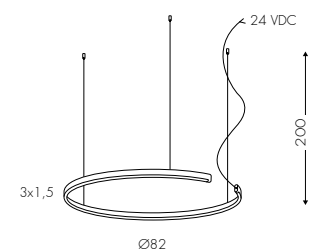

1032C54

65W 2750lm - 24VDC

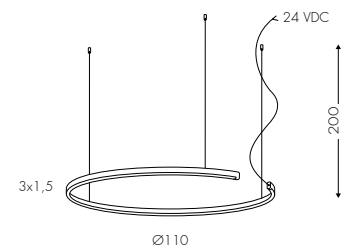

1032D54

90W 4150lm - 24VDC

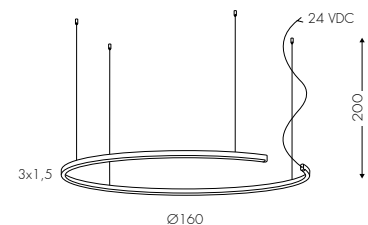

E2 Opale - Opal

A 2700K

B 3000K



Alimentatore non incluso - Power supply not included - Netzteil nicht inbegriffen

Esempio - Example - Beispiel *
1450lm con - with - mit E2







LEGGERA

Prodotto caratterizzato da una struttura leggera in alluminio verniciato a polveri, installabile a plafone. Sorgente luminosa Led IP54, alimentatore 24VDC escluso.

Linear lightweight ceiling lamp with powder-coated aluminium structure. IP Led light source. The 24VDC power supply is not included.

Deckenleuchte die sich durch eine leichte, pulverbeschichtete Aluminiumstruktur auszeichnet. IP54 LED Lichtquelle. Das 24VDC Netzteil ist nicht enthalten

3032A54

35W 1450lm* - 24VDC

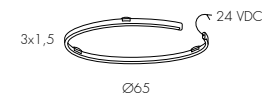

3032B54

48W 2150lm - 24VDC

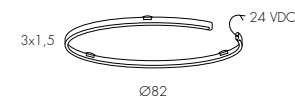

E2 Opale - Opal



B 3000K



 Alimentatore non incluso - Power supply not included - Netzteil nicht inbegriffen

Esempio - Example - Beispiel *
1450lm con - with - mit E2







LEGGERA

Prodotto caratterizzato da una struttura lineare leggera in alluminio verniciato a polveri, installabile a parete/plafone. Sorgente luminosa Led IP54, alimentatore 24VDC escluso.

Linear lightweight wall/ceiling lamp with powder-coated aluminium structure. IP54 Led light source. The 24VDC power supply is not included.

Decken- oder Pendelleuchte, die sich durch eine leichte, pulverbeschichtete Aluminiumstruktur auszeichnet. IP54 LED Lichtquelle. Das 24VDC Netzteil ist nicht enthalten.

3032G54

35W 1450lm* - 24VDC

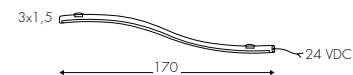

E2 Opale - Opal

 A 2700K

 B 3000K



 Alimentatore non incluso - Power supply not included - Netzteil nicht inbegriffen

Esempio - Example - Beispiel *
1450lm con - with - mit E2







 
MADE in ITALY

480

Una linea di compasso che riempie con eleganza lo spazio architettonico. Forme luminose circolari di medie e grandi dimensioni in versione "Outdoor", resistenti all'umidità, posizionabili anche in ambienti esterni.

A compass line that fills with elegance the architectural space . Medium-sized and large circular luminous shapes in "Outdoor" version, moisture resistant, can also be positioned in outdoor areas.

Eine Zirkellinie, die den architektonischen Raum mit Raffinesse füllt. Mittelgroße oder große leuchtende Formen, feuchtigkeitsbeständig, die in Außenbereichen positioniert werden können.



The image features a stylized logo on a teal background. A thick, dark teal ring is positioned in the upper left, with a white ring inside it. The word "BELLAI" is written in a bold, white, sans-serif font across the middle of the image. At the bottom, there is a curved, dark teal shape that resembles a shadow or a base. The overall design is clean and modern.

BELLAI



BELLAI

Apparecchio disponibile nelle versioni sospensione a luce diretta o plafone, diffusore opale e grado di protezione IP54. L'alimentatore è integrato nel corpo lampada.

This lamp is available in down-light suspension or ceiling versions with opal diffusor and IP54 protection degree. The power supply is integrated in the body lamp.

Diese Leuchte ist als direkte Lichtstrahl Hänge- oder Deckenversion mit Opaldiffusor und Schutzart IP54 erhältlich. Das Netzteil ist in den Lampenkörper integriert.

1025AOF54

50W 3810lm* - 220V

1025ADM54

DALI (Push) - 50W 3810lm - 220V

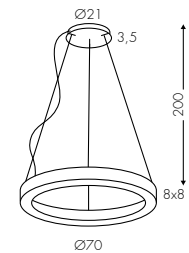

1025BOF54

65W 5168lm - 220V

1025BDM54

DALI (Push) - 65W 5168lm - 220V

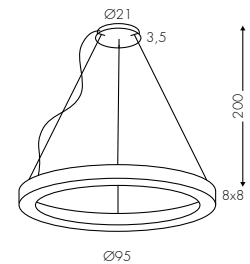

E2 Opale - Opal



A 2700K



B 3000K



Alimentatore Incorporato - Incorporated power supply - Eingebautes Netzteil







3025AOF54

50W 3810lm* - 220V

3025ADM54

DALI (push) - 50W 3810lm - 220V

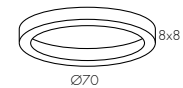

3025BOF54

65W 5168lm - 220V

3025BDM54

DALI (push) - 65W 5168lm - 220V

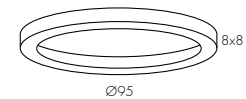

E2 Opale - Opal

 **A** 2700K

 **B** 3000K



Alimentatore Incorporato - Incorporated power supply - Eingebautes Netzteil







 
MADE in ITALY

Lampada in IP66 per l'illuminazione lineare diffusa o d'accento con ottica focalizzata. Materiali tecnici selezionati come il "Policarbonato UV Protect" e l'acciaio inox permettono l'uso della famiglia di prodotto DROP in sicurezza in ambienti umidi interni o in esterni anche esposti al sole.

IP66 Lamp for linear diffused lighting or accent lighting with focused optic. The technical materials selected as the "UV Protect Polycarbonate" and the inox steel allow the use of the DROP product family safely in humid environments or outdoor exposed to sun.

IP66 Lampe für eine diffuse und lineare Beleuchtung oder eine Akzentbeleuchtung mit konzentrierter Optik. Ausgewählte technische Materialien wie "UV Protect polycarbonat" und Inox Stahl ermöglichen die sichere Verwendung der DROP Produktfamilie in feuchtige Innen- und Aussenbereiche, auch wenn sie der Sonne ausgesetzt sind.





DROP



DROP

Lampada a led in IP66 per l'illuminazione lineare diffusa o d'accento di ambienti esterni. Alimentatore non incluso. Grazie agli accessori la lampada può anche essere sospesa, distanziata dalla parete o fissata nell'erba.

Lamp for outdoor lighting with IP66 protection level designed to obtain a diffused or accent lighting. Power supply not included. Thanks to the accessories, the lamp can also be suspended, distanced from the wall or fixed in the grass.

IP66 led-Leuchte für die diffuse oder betonte lineare Beleuchtung im Außenbereich. Das Netzteil ist nicht mit inbegriffen. Dank dem Zubehör kann die Lampe der Wand entfernt bleiben, aufgehängt oder im Gras befestigt werden.

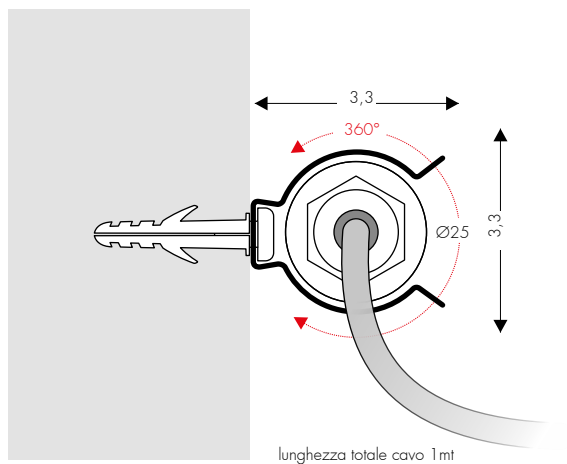





6010DV11	50cm 14.4W/mt 1600lm*/mt - 24VDC
6010DV21	100cm 14.4W/mt 1600lm/mt - 24VDC
6010DV31	150cm 14.4W/mt 1600lm/mt - 24VDC
6010DV41	200cm 14.4W/mt 1600lm/mt - 24VDC
6010DV51	250cm 14.4W/mt 1600lm/mt - 24VDC



Sfere in Gel di Silice Cobalt-Free per l'assorbimento della condensa.
Cobalt-free silica gel balls to absorb the condensation.
Kobaltfreie Kieselgel-Kugeln um die Kondensation zu absorbieren.



L30 Lente 30° - Lens 30° - Linse 30°
L220 Satinato - Frosted - Satiniert
E2 Opale - Opal

● **A** 2700K ● **B** 3000K
○ **C** 4000K ● **E** RGB

A Alimentatore non incluso - Power Supply not included - Netzteil nicht inbegriffen

Esempio - Example - Beispiel *
1600lm con - with - mit **L220** - 1600lm -15% con - with - mit **E2**



6010DV13	50cm 22W/mt 2300lm/mt - 24VDC
6010DV23	100cm 22W/mt 2300lm/mt - 24VDC
6010DV33	150cm 22W/mt 2300lm/mt - 24VDC
6010DV43	200cm 22W/mt 2300lm/mt - 24VDC
6010DV53	250cm 22W/mt 2300lm/mt - 24VDC



ACCIAIO CROMATO
CHROME STEEL
CHROMSTAHL

AISI 303



L30 Lente 30° - Lens 30° - Linse 30°
L220 Satinato - Frosted - Satiniert
E2 Opale - Opal

● **A** 2700K ● **B** 3000K
○ **C** 4000K

A Alimentatore non incluso - Power Supply not included - Netzteil nicht inbegriffen

Esempio - Example - Beispiel *

1600lm con - with - mit **L220** - 1600lm -1.5% con - with - mit **E2**



ACCESSORI

Accessori per il fissaggio della lampada 360 DROP che consentono di installarla in molteplici situazioni.

Kit of accessories and services that allow to install 360 DROP in many situations.

Zubehör zur Festsetzung 360 Grad DROP Lampe: es erlaubt die Montage in verschiedenen Bedingungen.



001005A

Servizio collegamento in serie
Line-up connection service
Reihenschaltung Service

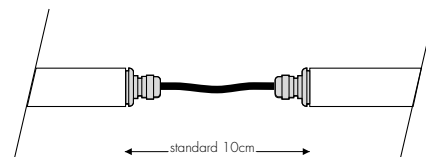

90106010

Coppia Collare antieffrazione
Couple anti-theft collar
Paar Anti-Diebstahl Kragen

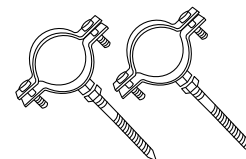

ACCIAIO ZINCATO
GALVANIZED STEEL
VERZINKTEM STAHL

90106008

Coppia picchetti INOX - Orizzontale
Couple INOX stakes for fied - horizontal
Paar INOX Pflöcke für Rasen - horizontal

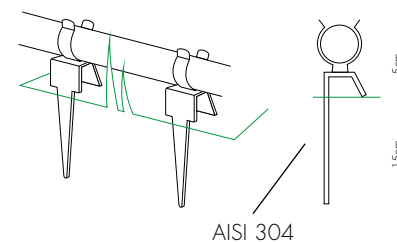

90106009

Coppia picchetti INOX - Verticale
Single INOX stake - vertical
Einzezpflöck INOX - vertikal

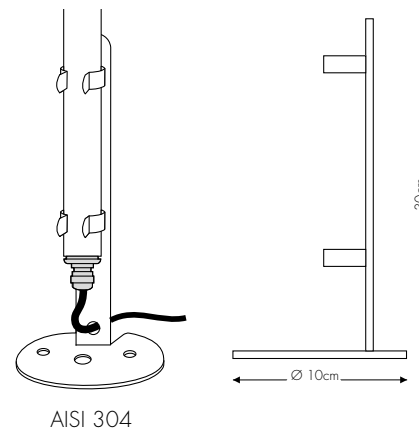

6010DSF15

coppia staffe inox 15cm
 Couple of 15cm inox brackets
 Paar 15 cm Edelstahlbügel

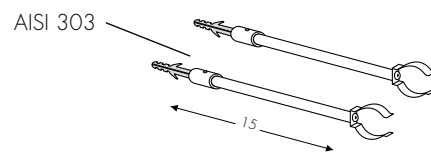
**6010DSF30**

coppia staffe inox 30cm
 Couple of 30 cm inox brackets
 Paar 30 cm Edelstahlbügel

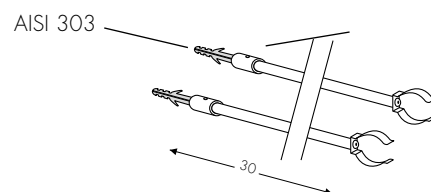
**6010DSOSP**

Kit sospensione DROP360
 Pendant KIT DROP360
 Pendel KIT DROP360

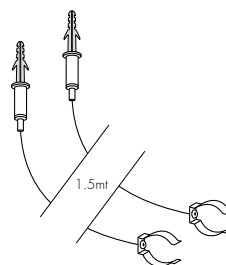
**CTT250FEP**

Aggiunta cavo 1 mt - 2 poli - fep+gomma Ø5,3
 1 mt adding cable - 2 poles - fep+rubber
 1 mt Kabel hinzugefügt - 2 Pole - fep+Gummi

**CTT450FEP**

Aggiunta cavo 1 mt - 4 poli - fep+gomma Ø5,8
 1 mt adding cable - 4 poles - fep+rubber
 1 mt Kabel hinzugefügt - 4 Pole - fep+Gummi





 
MADE in ITALY

494

Soluzione Architectural per
l'illuminazione radente di
ambienti esterni.

Outdoor product with an essential
shape for architectural wall
grazing lighting.

Eine Lösung aus wesentlicher
Linie für eine architektonische
Flachbeleuchtung im
Aussenbereich.





SIMPLY



SIMPLY

Versione a parete biemissione Up+Down IP54.
Corpo in metallo verniciato a polveri ed
alimentatore incorporato.

Up-down light emission for this wall lamp with
IP54. Powder coated metal body and built-in
power supply.

Wandausführung mit Up+Down
Lichtausstrahlung und IP54. Pulver lackierter
Metallkörper und eingebautes Netzteil.

2019EOF54

18W 1280lm* - 220V

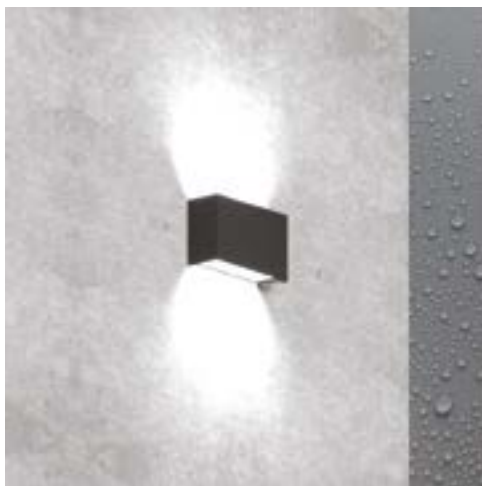
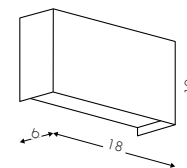

E28 Satinato - Frosted - Satiniert

B 3000K

BV NE RU



Alimentatore Incorporato - Incorporated Power Supply - Eingebautes Netzteil







SIMPLY

Versione a parete monoemissione downlight IP54. Corpo in metallo verniciato a polveri ed alimentatore incorporato.

Downlight IP54 mono-emission wall version. Powder coated metal body and built-in power supply.

Wandausführung mit einseitiger downlight IP54 Lichtausstrahlung.

2019FOF54

9W 640lm* - 220V

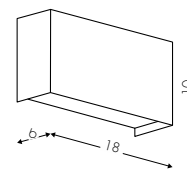

E28 Satinato - Frosted - Satiniert

B 3000K

BV NE RU



Alimentatore Incorporato - Incorporated Power Supply - Eingebautes Netzteil







 
MADE in ITALY

500

Oki è un oggetto semplice dalla forma squadrata per l'illuminazione diffusa dell'ambiente in grado di integrarsi tanto in contesti residenziali quanto in ambienti tecnici, anche in esterno.

Oki is a squared shape simple object for diffused lighting. it can be integrated both in residential contexts and in technical environments, even outdoors.

Oki ist ein einfaches Objekt mit einer rechteckigen Form für eine diffuse Beleuchtung der Umgebung. Es integriert sich sowohl in Wohn- als auch in technische Umgebungen, wie auch außen.



OKI

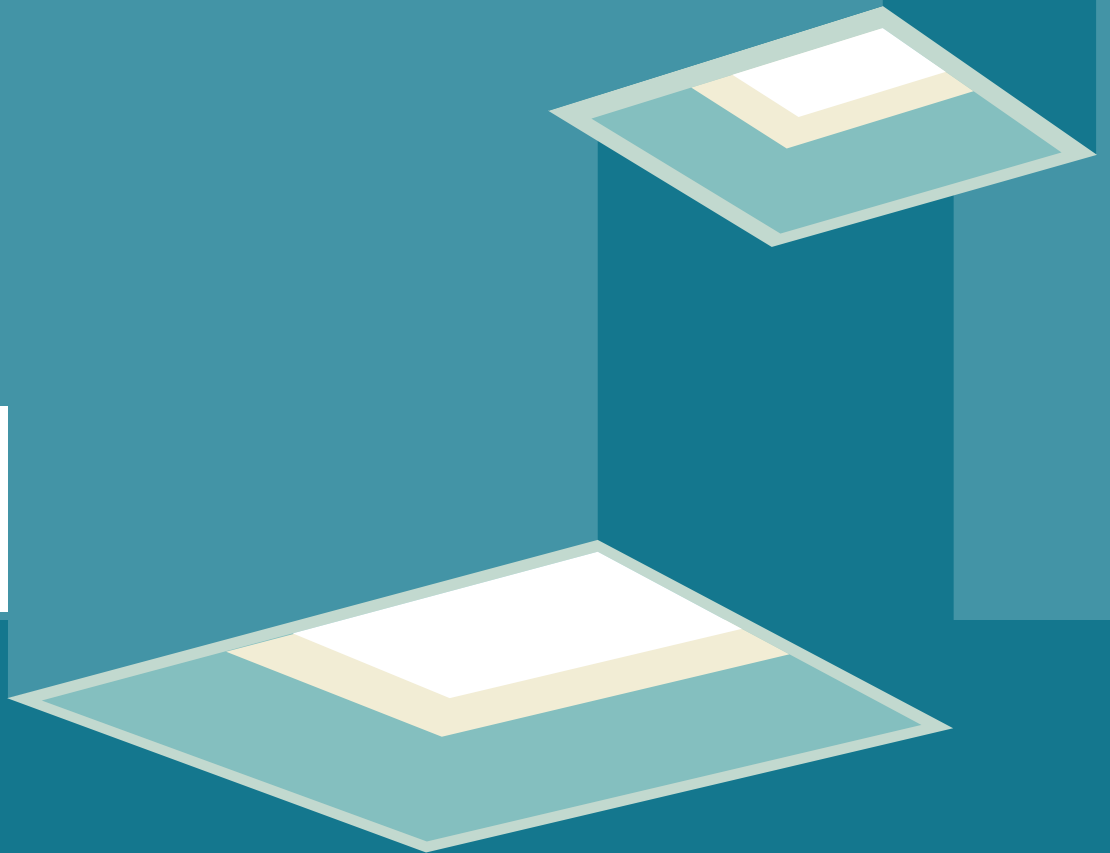



OKI

Apparecchio a plafone per l'illuminazione diffusa di ambienti interni ed esterni.

Corpo in alluminio verniciato e diffusore in PMMA Alimentatore incorporato.

Ceiling light designed for diffused lighting of interior and exterior environments.

Aluminium coated body lamp and PMMA diffuser. Built-in power supply.

Deckenleuchte für diffuses Licht im Innen- und Außenbereichen. Leuchtkörper aus lackiertem Aluminium mit PMMA Diffusor. Eingebautes Netzteil.



3009COF54 17W 1500lm* - 220V

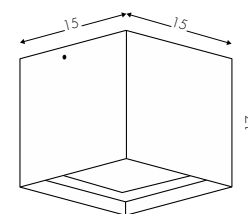

3009DOF54 17W 1500lm - 220V

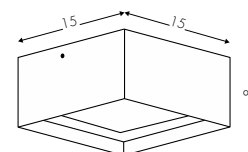

3009AOF54 13W 1000lm - 220V

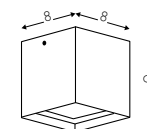

3009P54 9W 900lm - 24VDC

Alimentatore - Power supply - Netzteil

901024030 OnOff 30W 24VDC / 1-3 art. 3009P54

901024075 OnOff 75W 24VDC / 4-8 art. 3009P54

9010240240 OnOff 240W 24VDC / 9-20 art. 3009P54

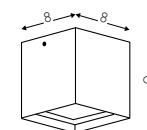

24V



E28 Satinato - Frosted - Satiniert

B 3000K

C 4000K



 Alimentatore Incorporato - Incorporated Power Supply - Eingebautes Netzteil
 Alimentatore non incluso - Power Supply not included - Netzteil nicht inbegriffen

Esempio - Example - Beispiel *
 1500lm con - with - mit **E28**







Serie di elementi ad incasso circolari per interni ed esterni dotati di ottica ad alta efficienza per l'illuminazione focalizzata.

Series of circular recessed lights for indoor od outdoor applications equipped with high efficiency optics for focused lighting.

Serie runder Einbauleuchten für Innen- und Außenbereiche mit hocheffizienter Optik für fokussierte Beleuchtung.



The background is a teal color, split diagonally from the top-left to the bottom-right. A darker teal triangle is in the top-left corner, and a lighter teal triangle is in the bottom-right corner. Two white ovals with a light teal glow are positioned in the upper half of the image. The text 'S-POT' is centered in the lower half.

S-POT



S-POT

Apparecchi ad incasso IP65 con sorgente led incorporata ad alta efficienza luminosa ed alimentatore incluso in remoto.

IP65 recessed lighting fixtures with built-in high luminous efficiency led source and remote power supply included.

IP65-Einbauleuchten mit integrierter Led-Quelle aus leistungsfähiger Lichtausstrahlung mit enthaltener Fernspeisung.



4017QOF

8W 860lm* - 220V

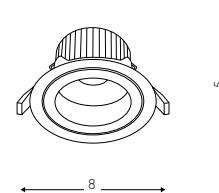
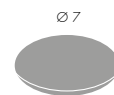

4017ROF

13W 1320lm - 220V

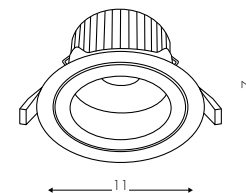
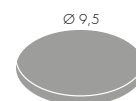

60° Ottica - Optic - Optik



B 3000K



C 4000K

BV



Alimentatore Incluso in remoto - Remote Power Supply - Fernspeisung enthalten







Valorizzare un'area di passaggio outdoor creando un effetto di illuminazione ritmata pensata per enfatizzare la profondità spaziale è il tema progettuale risolto da DOT una famiglia di "punti" luce segnapasso protetti dagli agenti esterni.

Enhancing an outdoor passage area by creating a rhythmic lighting effect designed to emphasize spatial depth is the design theme solved by DOT, a family of step light points protected by external agents.

DOT löst das Designthema der Aufwertung eines Durchgangsbereichs im Freien, durch die Schaffung eines rhythmischen Lichteffekts das die räumlichen Tiefe hervorhebt: eine Familie von Lichtpunkte die den Weg markieren, geschützt vor äußeren Witterungseinflüsse.



DOT

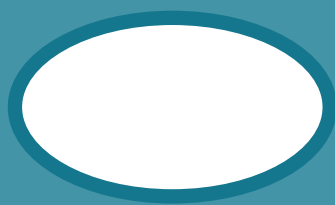



DOT

Spot luminoso ad incasso calpestabile non carrabile in alluminio anodizzato e vetro.
Accessori per l'installazione ed alimentatori disponibili ed acquistabili separatamente.

Walkable recessed spotlight not carriageable in anodised aluminum and glass. Installation accessories and power supplies are available and can be purchased separately.

Eingebauter Lichtstrahler - begehbar aber nicht befahrbar - aus eloxiertem Aluminium und Glas. Installationszubehör und Netzteile können separat erworben werden.



4042A

1W 120lm* - 350mA 3V

Alimentatore - Power supply - Netzteil

AE006I OnOff 4W 350mA / 1-3 art.4042A

AE006L OnOff 10W 350mA / 4-8 art.4042A

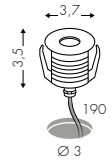

9042A

Controcassa - Outer Casing - Einbauhülse

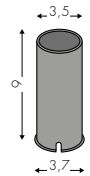

A 24° Ottica - Optic - Optik

B 3000K



A Alimentatore non incluso - Power Supply not included - Netzteil nicht inbegriffen

Esempio - Example - Beispiel *
120lm con - with - mit **24°**







4042B 3W 360lm* - 350mA 9V

Alimentatore - Power supply - Netzteil

AE006L OnOff 10W 350mA / 1-2 art.4042B

AE006M OnOff 18W 350mA / 3-5 art.4042B

9042B Controcassa - Outer Casing - Einbauhülse

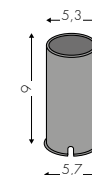
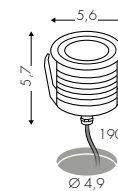

A 24° Ottica - Optic - Optik

B 3000K



A Alimentatore non incluso - Power Supply not included - Netzteil nicht inbegriffen

Esempio - Example - Beispiel *
360lm con - with - mit 24°



4042C

7W 840lm* - 350mA 20V

Alimentatore - Power supply - Netzteil

AE006L OnOff 10W 350mA / 1 art.4042C

AE006M OnOff 18W 350mA / 2 art.4042C

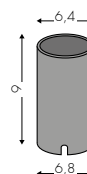
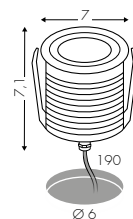

9042C

Controcassa - Outer Casing - Einbauhülse



A 24° Ottica - Optic - Optik

B 3000K

AL

A Alimentatore non incluso - Power Supply not included - Netzteil nicht inbegriffen

Esempio - Example - Beispiel*
840lm con - with - mit 24°



4042D

3W 360lm* - 350mA 9V

Alimentatore - Power supply - Netzteil

AE006L

OnOff 10W 350mA / 1-2 art.4042D

AE006M

OnOff 18W 350mA / 3-5 art.4042D

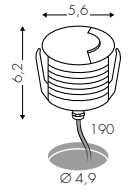

9042B

Controcassa - Outer Casing - Einbauhülse

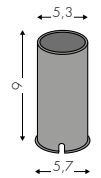

A 24° Ottica - Optic - Optik

B 3000K



A Alimentatore non incluso - Power Supply not included - Netzteil nicht inbegriffen

Esempio - Example - Beispiel *
360lm con - with - mit **24°**







4042E 3W 360lm* - 350mA 9V

Alimentatore - Power supply - Netzteil

AE006L OnOff 10W 350mA / 1-2 art.4042E

AE006M OnOff 18W 350mA / 3-5 art.4042E

9042B Controcassa - Outer Casing - Einbauhülse

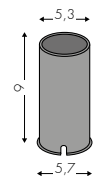
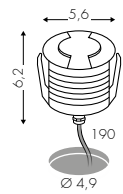

CE IP67 **A** 24° Ottica - Optic - Optik

B 3000K

AL

A Alimentatore non incluso - Power Supply not included - Netzteil nicht inbegriffen

Esempio - Example - Beispiel *
360lm con - with - mit 24°







Soluzione potente e compatta per l'illuminazione focalizzata; Se il contesto lo richiede "Flip" può essere facilmente orientato diventando una brillante soluzione per l'illuminazione d'accento di ambienti umidi interni o esterni esposti agli agenti atmosferici.

Powerful and compact solution for focused lighting; If the context requires it, "Flip" can be easily oriented becoming a brilliant solution for accent lighting in wet indoor environments or in outdoor exposed to atmospheric agents.

Zu Bedarf kann "Flip" einfach gelenkt werden und ist somit eine hervorragende Lösung für die Akzentbeleuchtung in feuchten Innenräumen, oder in Aussenbereichen die Witterungseinflüssen ausgesetzt sind.



FLIP





FLIP

Versione da terra con picchetto in materiale plastico facilmente riposizionabile.
Corpo in Alluminio verniciato a polveri e vetro, alimentatore incorporato.

Floor version with plastic picket, easily repositionable. Powder-coated aluminum and glass body, built-in power supply.

Stehversion mit Plastik-Pflock, leicht umstellbar. Körper aus pulverlackiertem Metall und Glass. Eingebautes Netzteil.

5043AOF

8W 815lm* - 220V

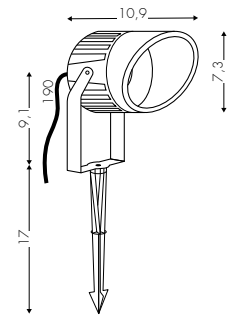

24° Ottica - Optic - Optik

B 3000K



A Alimentatore Incorporato - Incorporated Power Supply - Eingebautes Netzteil

Esempio - Example - Beispiel *
815lm con - with - mit 24°

520 indice fotografico







FLIP

Versione da parete orientabile con due gradi di libertà. Corpo in Alluminio verniciato a polveri e vetro, alimentatore incorporato.

Double degrees of freedom wall lamp.
Powder-coated aluminum body and glass,
built-in power supply.

Zwei Freiheitsgraden Wandleuchte.
Körper aus pulverlackiertem Metall und Glass.
Eingebautes Netzteil.

2043AOF

8W 815lm* - 220V

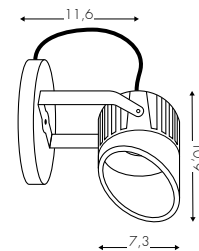

24° Ottica - Optic - Optik

 B 3000K

NE



Alimentatore Incorporato - Incorporated Power Supply - Eingebautes Netzteil

Esempio - Example - Beispiel *
815lm con - with - mit 24°







FLIP 24

Sistema di proiettori da esterno in bassissima tensione componibile su stelo predisposto per fissaggio a terra. Alimentatore 24VDC remoto non incluso.

System of modular outdoor low voltage spotlights on a ground stake.
Remotely 24VDC power supply not included.

System von modularen Niedervolt-Außenstrahlern auf einem Erdspieß.
Fernspeisung 24VDC nicht enthalten.



2043C

7W 815lm* - 24VDC

Alimentatore - Power supply - Netzteil

901024030

OnOff 30W 24VDC / 1-4 art. 2043C

901024075

OnOff 75W 24VDC / 5-10 art. 2043C

9010240240

OnOff 240W 24VDC / 11-30 art. 2043C

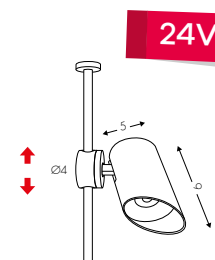

9043C

Paletto da terra - Ground stake - Bodenpfahl h60cm



9043D

Paletto da terra - Ground stake - Bodenpfahl h100cm



24° Ottica - Optic - Optik

● B 3000K

NE



Alimentatore non incluso - Power Supply not included - Netzteil nicht enthalten

Esempio - Example - Beispiel *
815lm con - with - mit 24°





LEGENDA







Superiore diffusa
Diffused Up



Superiore asimmetrica diffusa
Diffused asymmetrical Up



Superiore concentrata
Accent Up



Superiore asimmetrica concentrata
Accent asymmetrical UP



Inferiore diffusa
Diffused down



Inferiore asimmetrica diffusa
Diffused asymmetrical down



Inferiore concentrata
Accent Down



Inferiore asimmetrica concentrata
Accent asymmetrical down



Frontale diffusa
Diffused frontal



Inferiore diffusa + superiore diffusa
Diffused Up-Down



Inferiore dominante + superiore diffusa
Diffused down main emission + Up



Superiore diffusa + inferiore concentrata
Diffused Up + Accent down



Inferiore diffusa + superiore asimmetrica concentrata
Diffused down + asymmetrical up



inferiore concentrata + superiore concentrata
Accent down + Accent Up



Inferiore + superiore + frontale diffusa
Diffused Down + Up + frontal



Inferiore + laterale diffusa
Diffused Down + Side



360° diffusa
Omni diffused



Orientabile diffusa
Diffused Adjustable





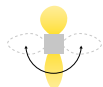







Orientabile concentrata
Accent Adjustable



Orientabile concentrata + superiore diffusa
Accent Adjustable + Diffused Up





-  Indica che un prodotto può circolare liberamente all'interno dell'Unione Europea: Certifica che il prodotto risponde ai requisiti essenziali di sicurezza.
Indicates that the product can circulate freely within the European Union: Certifies that the product meets the essential safety requirements.
Gibt an, dass ein Produkt innerhalb der Europäischen Union frei im Umlauf sein kann: Bescheinigt, dass das Produkt den wesentlichen Sicherheitsanforderungen entspricht.
-  Contatto a terra. Apparecchio in classe prima dotato solo dell'isolamento.
Ground contact. Fixture in first class equipped only with insulation.
Erdung Gerät in Klasse 1 nur mit Isolierung ausgerüstet.
-  Classe II doppio isolamento e/o isolamento rinforzato senza dispositivo di messa a terra.
Double insulation and/or reinforced insulation in every part and without ground devices.
Doppelte Isolierung, bzw.verstärkte Isolierung der Teile, ohne Vorrichtung Für Erdung.
-  Classe di protezione III - Apparecchi con bassa tensione protettiva. Apparecchi con protezione dallo shock elettrico attraverso la bassa tensione protettiva e che non funzionano con tensioni superiori.
Protection class III - Devices with extra-low voltage. Devices with protection from electric shock through the low-voltage protection. They don't work with higher voltages.
Schutzklasse III - Leuchten mit Kleinspannung. Geräte mit Schutz vor Stromschlag durch die Niederspannung. Sie arbeiten nicht mit höheren Spannungen.
-  Apparecchio adatto al montaggio su superfici normalmente infiammabili.
Suitable for mounting on normally inflammable surface.
Das Gerät ist zur Installation auf entflammable Oberflächen geeignet.
-  Protezione contro corpi estranei di medie dimensioni, nessuna protezione contro la penetrazione di acqua.
Protection against medium-sized foreign bodies, no protection against water penetration.
Schutz gegen mittelgroße Fremdkörper, ohne Schutz gegen Eindringen von Wasser.
-  Protetto contro la polvere. Protetto da spruzzi di ogni tipo.
Protected from limited dust ingress. Protected from water spray from any direction.
Staubgeschützt - Schutz gegen Spritzwasser.
-  Totalmente protetto contro la polvere. Protetto contro i getti d'acqua con lanci da tutte le direzioni.
Protected from total dust ingress. Protected from high pressure water jets from any direction.
Staubdicht - Schutz gegen starkes Strahlwasser.
-  Totalmente protetto contro la polvere. Protetto da ondate.
Protected from total dust ingress. Protected from waves.
Staubdicht - Schutz gegen starkes Strahlwasser.
-  Totalmente protetto contro la polvere. Protetto contro gli effetti di immersione.
Protected from total dust ingress. Protected against immersion effects.
Staubdicht. Geschützt gegen eintauchen.
-  Protetto contro l'energia d'urto 2J.
Protected against impact energy 2J.
Geschützt gegen Aufprallenergie 2J.



TONALITÀ LUCE LED - LED LIGHT HUE - LED LICHT FARBTON



A 2700K



B 3000K



C 4000K



D 2700K-6500K



E RGB



ALIMENTATORE - POWER SUPPLY - NETZEIL

A

Alimentatore Incorporato - Incorporated Power Supply - Eingebautes Netzteil

A

Alimentatore nel rosone - Power Supply inside the ceiling rose - Netzteil in der Deckenrose

A↑

Alimentatore Incluso in remoto - Included Power Supply in remote - Einbezogen Netzteil

A✗

Alimentatore non incluso - Power Supply not included - Netzteil nicht inbegriffen

GU10

Sorgente GU10 non inclusa - GU10 light source not included - GU10 lichtquelle nicht enthalten

E27

Sorgente E27 non inclusa - E27 light source not included - E27 Lichtquelle nicht Enthalten



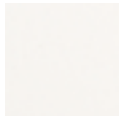

BV Bianco - White - Weiß



NE Nero - Black - Schwarz



RU Ruggine - Rust - Rost



RV Rame verniciato - Painted copper - Kupfer lackiert



OV Oro verniciato - Painted gold - Gold lackiert



BR Bronzo - Bronze - Bronze



AL Alluminio - Aluminium - Aluminium



SO Spazzolatura orbitale - Brushed aluminium
Gebürstetes Aluminium



OS Oro spazzolato - Brushed Gold
Gebürstetes Gold



FO Oro - Gold



FA Argento - Silver



PREZZI:

Unitari al pubblico **senza IVA (euro)**. I prezzi si intendono lampadine escluse, eccetto là dove specificatamente indicate incluse a listino.

ECOCONTRIBUTO RAEE:

In conformità alla direttiva che disciplina lo smaltimento di apparecchi elettrici ed elettronici (D.lgs 151/2005) si applica l'ecotributo previsto dalla disposizione. Versati ove dovuti.

ORDINI:

Minimo l'ordine 155,00 (al netto di IVA e di sconti). L'accettazione è sempre soggetta all'approvazione della direzione con facoltà di effettuare spedizioni anche parziali, salvo esplicita indicazione da parte del committente.

TERMINI DI CONSEGNA:

I termini di consegna convenuti non sono impegnativi. Un eventuale ritardo non può dar luogo da parte del committente alla risoluzione dell'ordine, nè a qualsiasi pretesa di risarcimento danni. Team Italia ha la facoltà di sospendere la fornitura quando le condizioni economiche del cliente risultassero tali da porre in evidente pericolo il conseguimento del pagamento o per altri motivi di carattere commerciale e di gestione di Team Italia.

PORTO:

Porto franco per consegne di valore, al netto di IVA e di sconti, superiore a 600,00. (previo accordi)

GARANZIA

I prodotti Team Italia sono garantiti a norma di legge per due anni.

RECLAMI

I reclami per merce difettosa potranno essere accettati solo dietro la presentazione della copia del documento fiscale attestante l'acquisto e la corretta compilazione del modulo di reclamo da inviare entro 8 giorni dalla consegna del materiale. Team Italia si riserva il diritto di riparare e/o sostituire il prodotto difettoso con un altro prodotto simile o equivalente; sono esclusi costi di manodopera per la sostituzione degli apparecchi e comunque ogni danno, sia pure indirettamente, connesso con la difettosità dell'apparecchio.

RESI:

Eventuali resi dovranno essere da noi preventivamente autorizzati attendendosi alle istruzioni fornite.

MODIFICHE:

Fermo restando le caratteristiche basilari degli articoli, l'azienda si riserva di apportare eventuali modifiche per conformare alla normativa vigente e/o migliorare la qualità. Per ogni controversia è responsabile il Foro di Verona.

IL PRESENTE CATALOGO ANNULLA E SOSTITUISCE OGNI PRECEDENTE.

PRICES:

Unit prices for public **without VAT (euro)**. Prices do not include light bulbs, except where specifically indicated in the price list.

ORDERS:

Minimum order 200,00 net of VAT and discounts. Acceptance is always subject to approval by the management, who reserve the right to make split deliveries, except in the case of specific requirements set by the purchaser.

DELIVERY TERMS:

Agreed delivery deadlines are not binding. Eventual delays cannot be considered by the purchaser as a motive for withdrawing the order or for compensation for damages. Team Italia reserves the right to suspend shipments when the customer's financial conditions are such that payment of the invoice is at risk, or for other reasons based on Team Italia's commercial or management policies.

SHIPPING FEES:

Shipping costs, to be agreed, vary depending on the country of destination

WARRANTY:

Team Italia products are guaranteed for a period of 2 years.

CLAIMS:

Eventual claims or breakages must be reported within 8 days from the delivery of the goods. Claims for defective goods can only be considered, and the goods can be returned and repalced, only by presenting a copy of the fiscal document proving the relevant purchase, and filling the claim form supplied by Team Italia. Team Italia reserves the right to repair and/or replace the defective product with another similar or equivalent; Replacement labor costs of the devices are excluded and also any damage connected with the defectiveness of the device.

RETURNS:

Eventual returns must be authorised by us in advanced, in conformity with the instructions given.

MODIFICATIONS:

While the basic characteristics of the article remain unchanged, the company reserves the right to modify the products in order to conform with the regulations in force and/or to improve the quality. Any litigation will be dealt with by the Courts in Verona.

THE PRESENT CATALOG REPLACES ALL PREVIOUS ONES.

PREISE:

Einheitspreise **ohne MWVS (euro)**. Die preise verstehen sich ohne Glühbirnen, mit Ausnahme dort, wo sie im Verzeichnis ausdrücklich als inklusiv angegeben werden.

AUFTRÄGE:

Mindestauftrag Euro 200,00. Die Annahme ist immer vor der Zustimmung der Direktion abhängig mit der Befugnis, auch Teillieferungen vornehmen zu können, es sei denn, das ausdrückliche Hinweise seitens des Auftragsgebers bestehen.

LIEFERTERMINE:

Die vereinbarten Lieferungstermine sind unverbindlich. Eine eventuelle Verspätung gibt seitens des auftragsgebers weder anlass zur auftragsauflösung noch anspruch auf jeglichen Schadenersatz. Team Italia behält sich das Recht vor die Lieferung zu unterbrechen, sollte der finanzielle Zustand des Kunden die Zahlung offensichtlich gefährden oder aus anderen kommerzielle oder Leitungs-Gründen von Team Italia.

VERSANDKOSTEN:

Die zu vereinbarenden Versandkosten variieren je nach Bestimmungsland

GARANTIE:

Team Italia Produkte sind nach gesetzlichen Vorgaben 2 Jahre garantiert.

BESCHWERDEN:

Eventuelle Reklamationen oder Beschädigungen müssen nach Ablauf von 8 Tagen nach Warenerhalt schriftlich bekannt gegeben werden. Die Beschwerden für defekte Produkte können nur hinter Einreichung des Steuerbelegs, der den Kauf bescheinigt, akzeptiert werden und nach der korrekten Asfüllung des Beschwerdeformulars der innerhalb 8 Tagen nach der Lieferung der Produkten einzusenden ist. Team Italia behält sich das Recht vor die defekte Produkte zu reparieren und/oder sie mit anderen ähnliche oder gleichwertige Produkten zu ersetzen. Die Arbeitskosten für den Ersatz der Geräte sind nicht mit inbegriffen, sowol auch nicht jegliche Schaden die auch indirekt mit dem Defekt des Produktes verbunden sind.

RÜCKGABE DER WARE:

Eventuelle Warenrückgaben müssen von uns autorisiert werden, wobei man sich an die beigelegten Anweisungen halten sollte.

ÄNDERUNGEN:

Die grundlegenden Charakteristiken der Artikel bleiben erhalten, der Betrieb behält sich jedoch vor, eventuelle Änderungen vorzunehmen, um das Produkt den gültigen Normen anzupassen und/oder die Qualität zu verbessern. Für alle Rechtsfragen ist der Gerichtsstand Verona zuständig.

DIE VORLIEGENDE KATALOG ANNULLIERT UND ERSETZT ALLE VORHERGEHENDEN.



COPYRIGHTS

Le immagini inserite sono a scopo illustrativo. Le caratteristiche ed i colori possono differire da quanto rappresentato" (es. sul retro copertina).

The pictures are only for illustrative purposes. The features and colors may be different from what shown " (e.g. on the back cover).

Die Bilder werden zu Erläuterungszwecken enthalten. Die Eigenschaften und Farben können von diesen Darstellungen unterscheiden "(z. B. auf der Rückseite).

Tutti i diritti riservati. Nessuna parte del presente catalogo può essere riprodotta o diffusa con fotocopie, microfilm, o con qualsiasi altro mezzo senza il permesso del titolare del copyright.

All rights reserved. None of this catalogue may be reproduced or diffused in the form of photocopies, microfilm or by any other means without the permission of the copyright owner.

Alle Rechte sind vorbehalten. Es ist nicht gestattet, den vorliegenden Katalog durch Kopierung, Mikrofилme oder jeglicher anderer Mittel ohne die Erlaubnis des Copyrightberechtigten zu drucken oder aber in Umlauf zu bringen.

L'azienda si riserva il diritto in qualunque momento di apportare senza preavviso modifiche a prodotti ed accessori. La tonalità dei colori è puramente indicativa.

The company reserves the right at any time without prior notice to make changes to products and accessories. The color tone is purely indicative.

Die Firma behält sich das Recht vor, jederzeit ohne vorherige Ankündigung Änderungen an Produkten und Zubehör zu machen.

Der Farbton ist rein indikativ.

TeamItalia

© COPYRIGHT 2022

coordinatori Maurizio Pisani/Alessandro Sbrozzeri
fotografia Team Italia Communication Lab
immagini 3D Biefferender
progetto grafico Michele Zenatti
illustrazioni Gianni Morandini
stampa Eurotipo





teamitaliailluminazione.it