



**CAT
ALOGUE**

 intra lighting

INDEX BY ALPHABET

ACOUSTO	271	LINELED	335
ALKON	527	LINELED FLEX <small>NEW</small>	327
ARAGO	545	LIY <small>NEW</small>	351
ATOS	345	LONA	461
BIBA	29	LYNAR <small>NEW</small>	215
BLACK HOLE <small>NEW</small>	71	LYSABEL	91
CAMAY	163	MEDIS	531
CANVAS	509	MINUS	145
CEILING CUPS	561	MOCCA	158
CONIC <small>NEW</small>	359	NARRO	445
COVE	319	NIGHT & DAY	151
CUB	425	NITOR	437
CUT <small>NEW</small>	301	NOLA	453
DAWN	61	NUCLEO	449
DEMI	513	PIPES	395
DEUX PIECES	383	PIPES R	365
EDGE	309	PIPES TUBE	107
ERGETIC	503	PIXY <small>NEW</small>	41
ETEA	479	RANDOM	187
EYE <small>NEW</small>	389	RYLO <small>NEW</small>	377
EYEN	113	RYLO PRO <small>NEW</small>	205
FLEA, FYO	339	SEQUAL	537
FLOTT	431	SKYLER	493
FUTON	79	SWORD	295
GLAZER	141	TOL	499
GRAMM <small>NEW</small>	135	TRACKER <small>NEW</small>	281
GYON	235	TRACKS	559
HARON	553	TRIX	227
HEXAGON	195	VITKA	125
HUNTER	415	VYKO <small>NEW</small>	483
INSIDER <small>NEW</small>	119	WAVE	255
ISSA <small>NEW</small>	99	ZOE	51
KALIS	167	106 & 216	523
KARO	475	5700	549

INDEX BY CATEGORY

DECORATIVE	29
LINEAR & SYSTEMS	125
COVE	309
SPOTS & DOWNLIGHTS	339
GENERAL	453
HEALTH & CARE	527
INDUSTRIAL	537
OUTDOOR	553
TECHNICAL PAGES	559



Light
brings
life

Close to the sun. Close to the sunlight.

We are constantly torn between testing the limits and safe comfort. Life and illumination are all about balance. Only with the right balance between the light and the dark you can see the world in its most beautiful shapes and colours. Keep your eyes open, find your balance and inspiration. Shine!

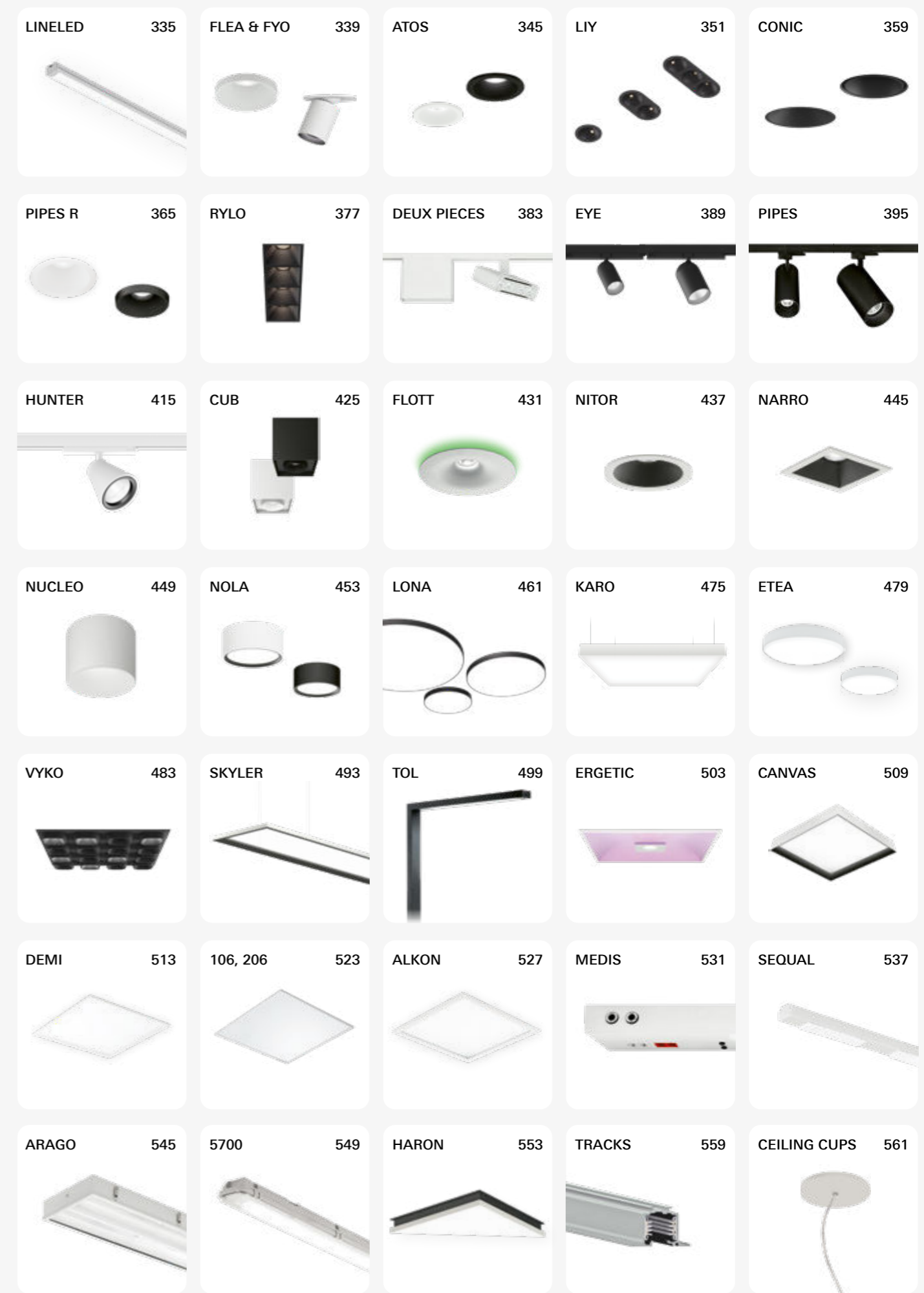

DECORATIVE

Biba

Tiny sophistication

29
40



SLIM



DROP



EDGY



Pixy

NEW

Authentically magnetic

41
49



S



C/W



C/W - BAR



Zoe

Light up your creativity

51
60



UNO



DUO



Dawn

NEW VERSION

Morning light

61
70



S



F



Black Hole

NEW

Extreme phenomenon

71
78



SDI



Futon

NEW VERSIONS

Night's silence

79
89



C/W ACOUSTIC



S ACOUSTIC



SD ACOUSTIC



SD OPAL



MIRROR

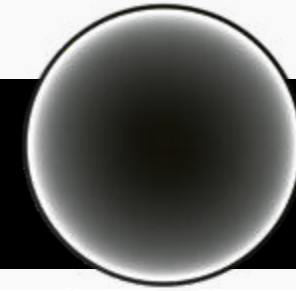

Lysabel

NEW

A saber of light

91
98

S



S C

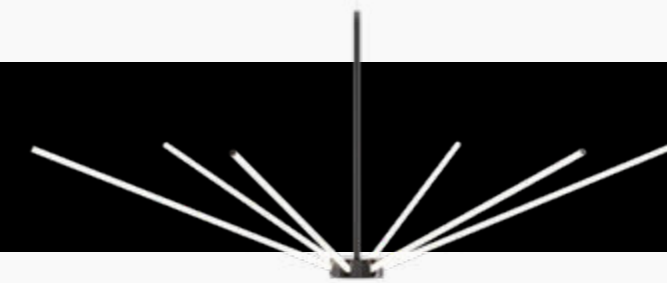

Issa

NEW

Miss impact

99
106



S H



S V



S VS



Pipes Tube

Vertical accent

107
112



C/S SINGLE



C/S CLUSTER

Eye

An eye-catcher

113
118



S 6



S / SDI 12

Insider

Directly indirect

119
124



W

LINEAR

Vitka

Thin line

125
133



S



SQ



F



FQ



TA

Gramm

The lightest light

135
140



S LGO



S SOP

Glazer

Table friendly

141
144



SDI

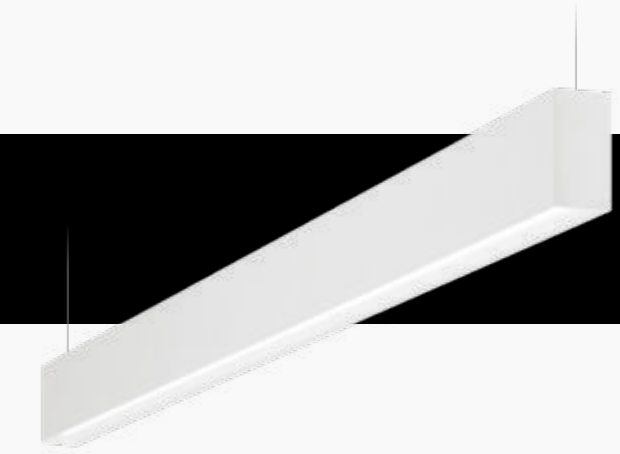

Minus

Make rhythm, brake rhythm

145
150



C



S



S Square

Night & Day

Changes by turning

151
156

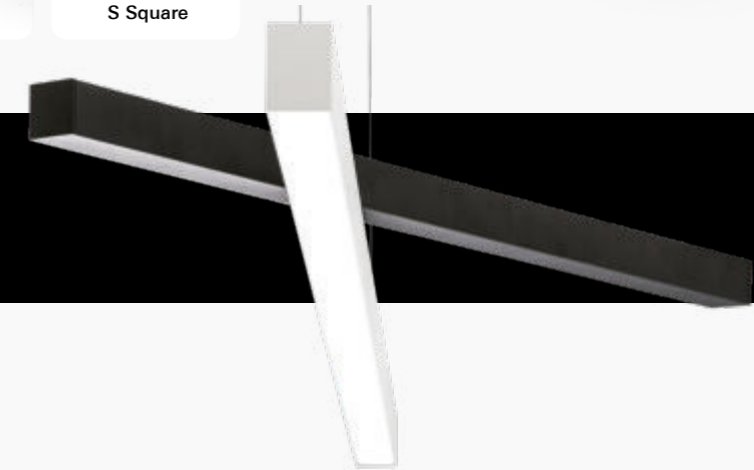

SDI

Mocca

Be bold or italic. Never regular.



158

162



SDI

Camay

Timeless elegance



163

166



S/SDI



W/WDI

Kalis

NEW VERSION

Absolutely universal

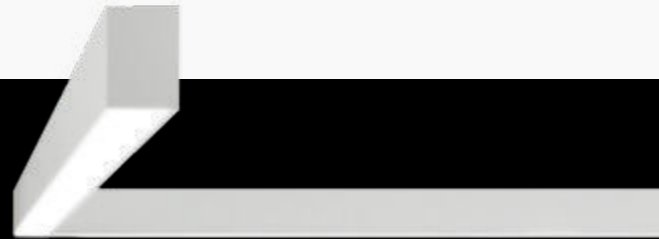

167

185

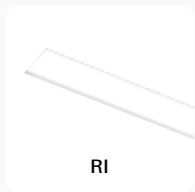

RI



RV

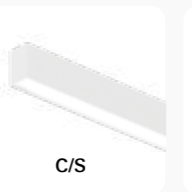

C/S

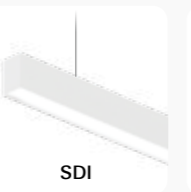

SDI



W/WDI



T

Random

Not random at all



187

193

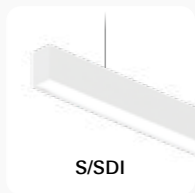

S/SDI

Hexagon

Don't be a square

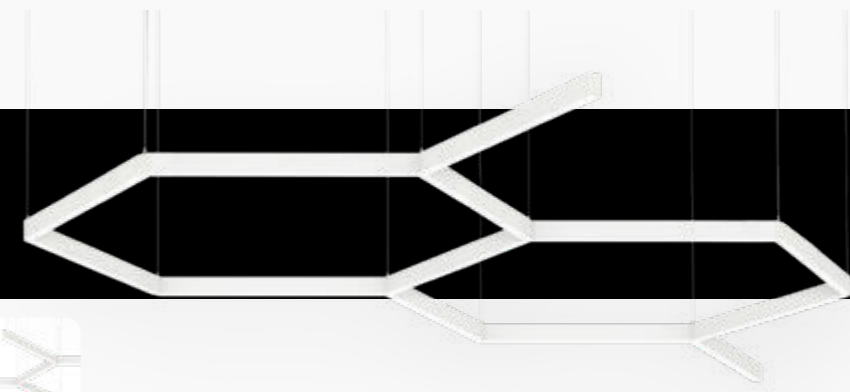

195

204



S/SDI

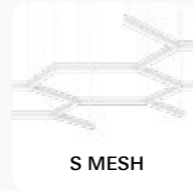

S MESH

Rylo Pro

NEW

Office first



205

213



RI



RV



C/S



SDI



S/SDI



FDI



FDIT

Lynar

NEW

It's your move



215

225



RI

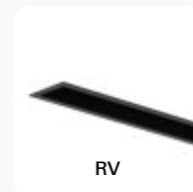

RV



C/S



SDI

Trix

NEW

Uncompromising, no tricks



227

234

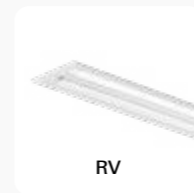

RV



C/S



SDI

Gyon NEW VERSION
More is more



235
253

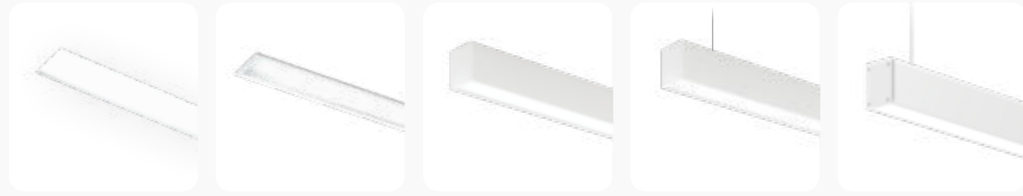

Wave & Wave round
Bored with being straight



255
269



Acousto
Acoustic comfort



271
279



Tracker
Goes with the flow



281
293



Sword
Power comes with size



295
300

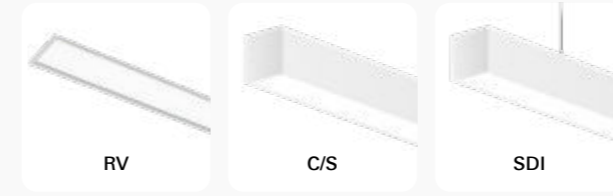

Cut NEW
Clear vision



301
307



COVE LIGHTING

Edge NEW VERSION
Light graphics

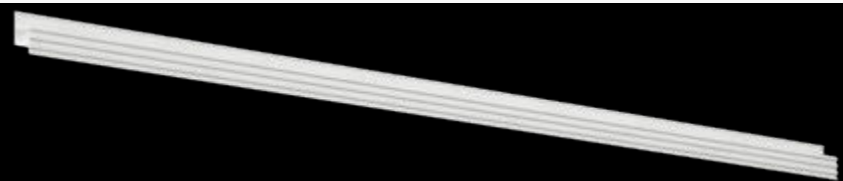

309
318

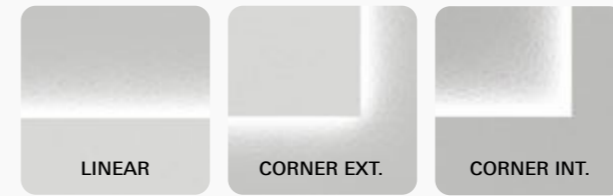

Cove
It's all light



319
326



LineLED Flex ^{NEW}

All flexible

327
334



LR 0410

UD 1312

LR 1217

LineLED

Behind the scenes

335
338



RVW

CS

CT

SPOTS & DOWNLIGHTS

Flea & Fyo

Less is more

339
343

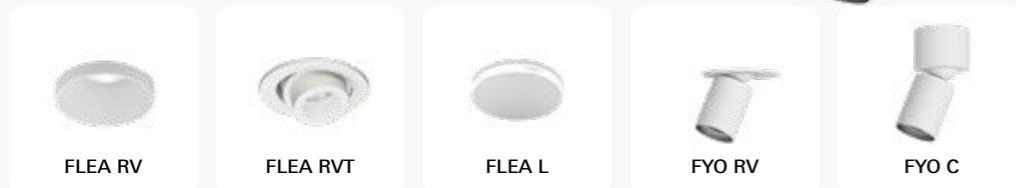

FLEA RV

FLEA RVT

FLEA L

FYO RV

FYO C

Atos ^{NEW VERSION}

A mighty mite

345
349



RV

RVO

CL

RIO/RVQ

Liy ^{NEW}

Maximally minimal

351
358

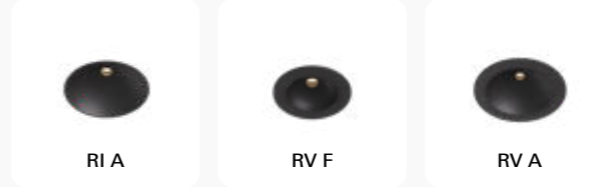

RI A

RV F

RV A

Conic ^{NEW}

An iconic spot

359
364



RI F

RI A

RV F

RV A

Pipes R

Totally responsive

365
375

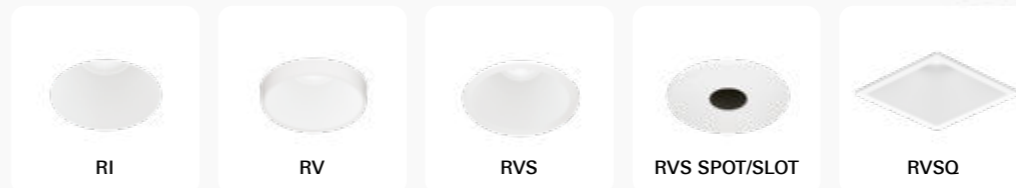

RI

RV

RVS

RVS SPOT/SLOT

RVSQ

Rylo ^{NEW}

Extraordinary light comfort

377
382

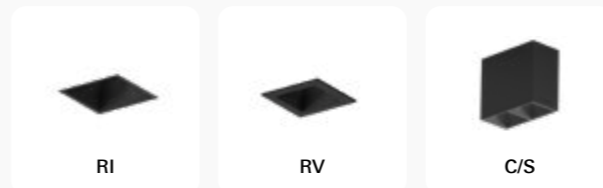

RI

RV

C/S

Deux pièces

Simple and flexible

383
388

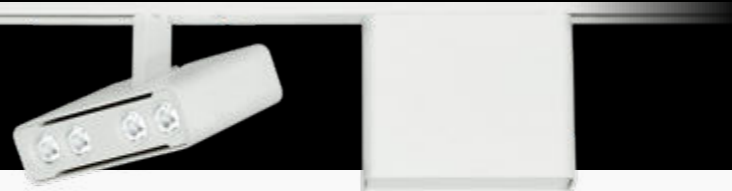

RI



T

Eye ^{NEW}

Good looking all around

389
394

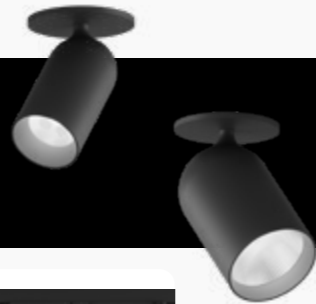

C 60



C 80



T 60



T 80

Pipes

Simple outside, clever inside

395
413



RIO / RVO



SRI



T



C



CF



S

Hunter ^{UPDATED}

Call to action

415
423



RI



RV



RIO / RVO



T



C



S

Cub

Hide and seek

425
430

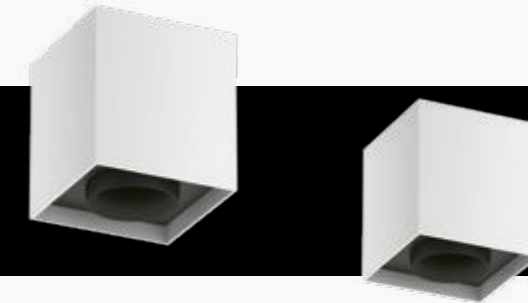

C



C3

Flott

Not a typical downlight

431
436

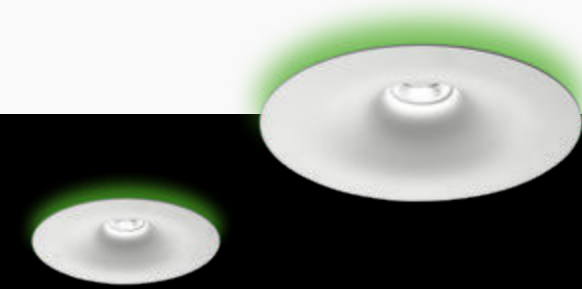

RV

Nitor ^{UPDATED}

Simply efficient

437
443



RV FLAT



RV PRO



RV HE

Narro

Not round at all

445
448

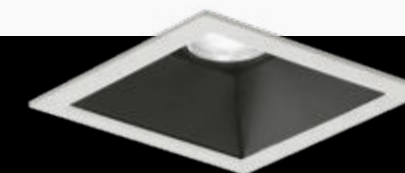

RV PRO



RV FLAT

Nucleo

It's a one-piece thing



449
452



GENERAL

Nola

Lona's little sister

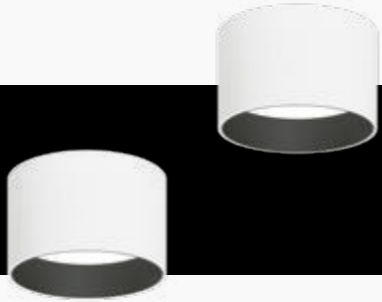

453
459



RV



C



S

Lona ^{UPDATED}

Fits everywhere



461
473



RV



C/S



CDI



SDI

Karo

Simply square

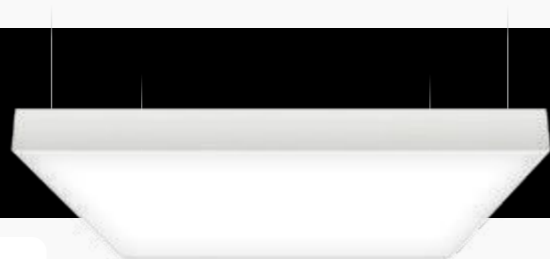

475
478



RV



C



S

Etea

Basic advanced



479
482



D



DI



DF

Vyko ^{NEW}

Ec(h)o friendly



483
492



LFO



Deco



Dark

Skyler

The sky is the limit



493
498



SDI

Tol

Mobile and personal



499
502



F

Ergetic

All-in-one



503
508



RV

Canvas

Out of the box



509
512



RV

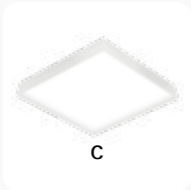

C

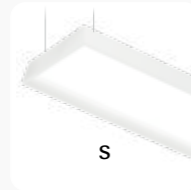

S

Demi

Office reviver



513
521



RV

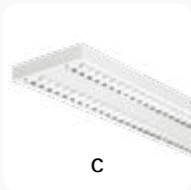

C



SDI

106,216

Basic light box

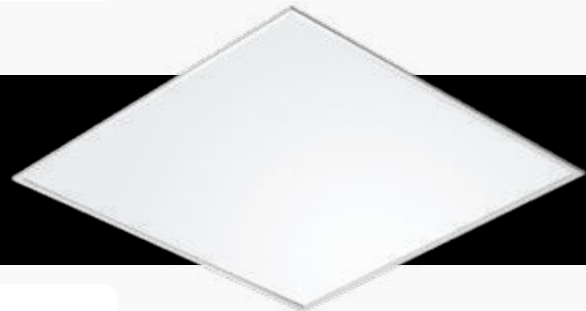

523
526



106 MC



106



216 C/S

HEALTH & CARE

Alkon

Clean room choice



527
530

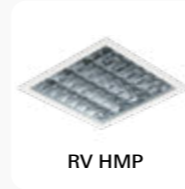

RV HMP



RV DPR



RV PR

Medis

Care 24 / 7



531
535



W

INDUSTRY

Sequal

Specialised in optics



537
543

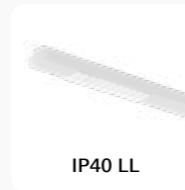

IP40 LL



IP54



IP65

Arago

Born to be efficient



545
548



IP65



IP65 GRID



IP65 INOX

5700

The old-school solution



549

552



OUTDOOR

Haron

Imagine. Create. Repeat.



553

558



ACOUSTIC

Black Hole ^{NEW}

Extreme phenomenon



71

78



Futon ^{NEW VERSIONS}

Night's silence

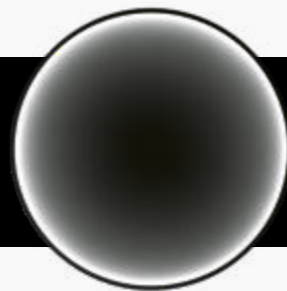

79

89



Acousto

Control your sound

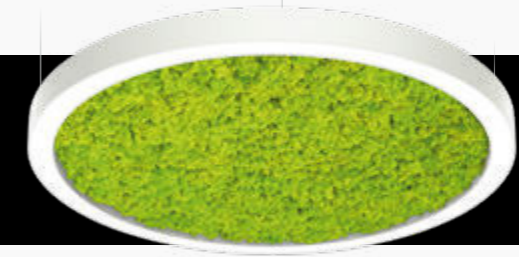

271

279



Vyko ^{NEW}

Ec(h)o friendly

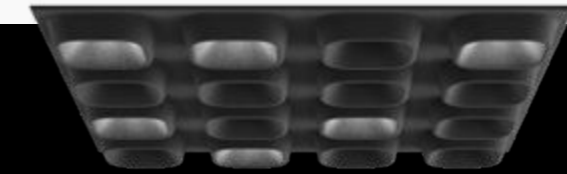





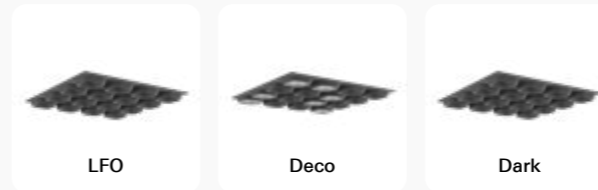

















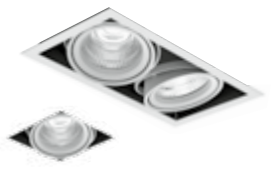

483













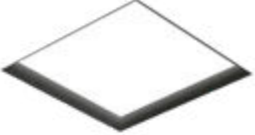

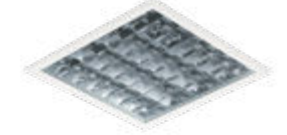





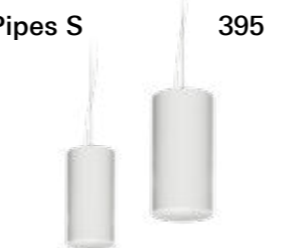

492





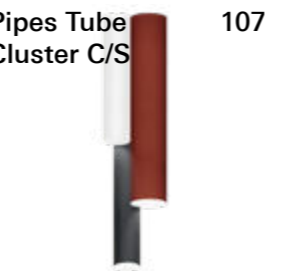

























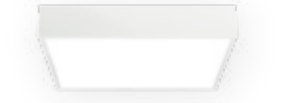









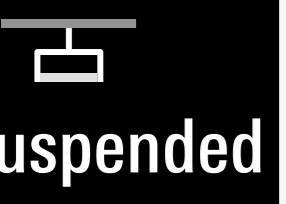

recessed
>

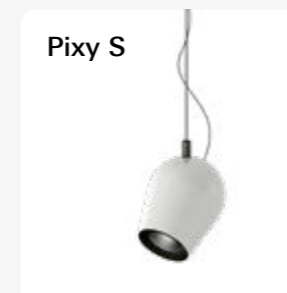
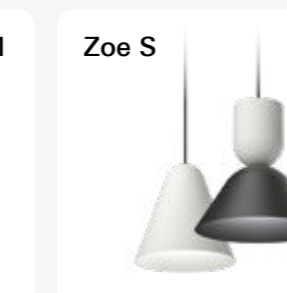



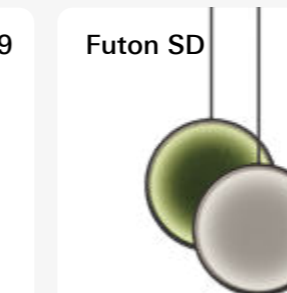
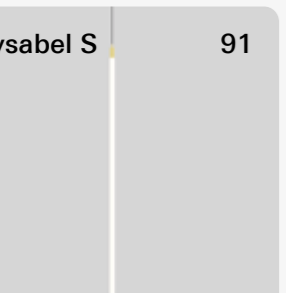
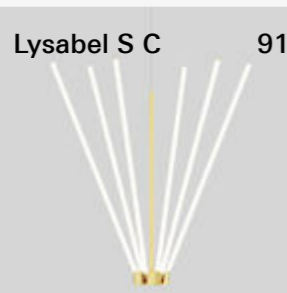

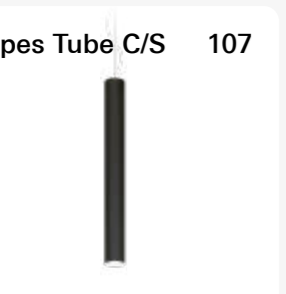
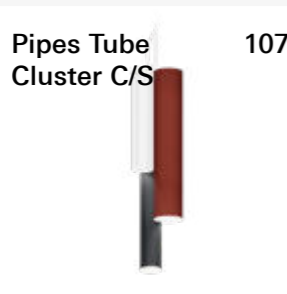
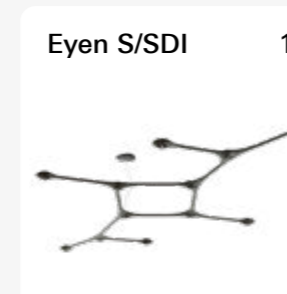



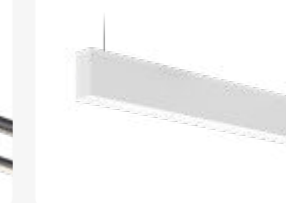

Kalis RI 167 	Kalis RV 167 	Rylo Pro RI 205 
Rylo Pro RV 205 	Lynar RI 215 	Lynar RV 215 
Gyon RI 235 	Gyon RV 235 	Tracker RI 281 
Cut RI 301 	Edge 309 	Sword RV 295 
LineLED RV 335 	Flea RV 339 	Fyo RV 339 
Atos RVO 345 	Liy RI A 351 	Liy RV F 351 
		Liy RV A 351 

Conic RI 359 	Conic RV 359 	Pipes R RI 365 	Pipes R RV 365 
Pipes R RVS 365 	Pipes R RVSQ 365 	Rylo RI 377 	Rylo RV 377 
Deux pièces RI 383 	Pipes RIO/RVO 395 	Pipes SRI 395 	Hunter RI/RV 415 
Hunter RIO/RVO 415 	Flott RV 431 	Nitor RV FLAT 437 	Nitor RV PRO 437 
Nitor RV HE 437 	Narro RV FLAT 445 	Narro RV PRO 445 	Nola RV 453 
Lona RV 461 	Karo RV 475 	Vyko LFO 483 	Vyko Deco 483 

Vyko Dark 483 	Ergetic RV 503 	Canvas RV 509 	Demi RV 513 
106 523 	Alkon RV 527 	track > 	Kalis T 167 
Deux pièces T 383 	Eye T 389 	Pipes T 395 	Pipes S 395 
Hunter T 415 	Hunter S 415 	ceiling > 	Pixy C/W 41 
Pixy C/W - BAR 41 	Futon C/W 79 	Pipes Tube C/S 107 	Pipes Tube Cluster C/S 107 
Minus C 145 	Kalis C/S 167 	Rylo Pro C/S 205 	Lynar C/S 215 

Trix C/S 227 	Gyon C/S 235 	Wave C/S 255 	Wave round C/S 255 
Acousto C/S 271 	Acousto C/S 271 	Sword C/S 295 	
Cove C 319 	LineLED Flex 327 	LineLED C 335 	Fyo C 339 
Fyo CL 339 	Rylo C/S 377 	Eye C 389 	Pipes C/CF 395 
Hunter C 415 	Cub C 425 	Cub C3 425 	Nucleo C 449 
Nola C 453 	Lona C/CDI 461 	Karo C 475 	Canvas C 509 

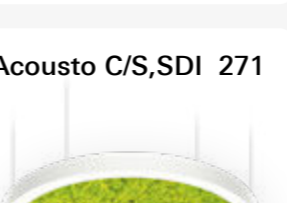
Demi C 513 	216 C/S 523 	Sequal IP40 LL 537 	Arago C 545 
5700 C 549 	Haron T 553 	Haron SQ 553 	Haron L 553 
 suspended >	Biba S 29 	Pixy S 41 	Zoe S 51 
Dawn S 61 	Black Hole SDI 71 	Futon S 79 	Futon SD 79 
Lysabel S 91 	Lysabel S C 91 	Issa S H 99 	Issa S V 99 
Pipes Tube C/S 107 	Pipes Tube Cluster C/S 107 	Eyen S/SDI 113 	Vitka S 125 

Vitka SQ 125 	Gramm S 135 	Glazer SDI 141 	Minus S 145 
Minus S SQ 145 	Night & Day SDI 151 	Mocca SDI 158 	Camay S, SDI 163 
Kalis C/S, SDI 167 	Random S, SDI 187 	Hexagon S, SDI 195 	
Rylo Pro S,SDI 205 	Rylo Pro SDI 205 	Lynar C/S, SDI 215 	Trix C/S, SDI 227 
Gyon C/S,SDI 235 	Wave C/S,SDI 255 	Wave round C/S, SDI 255 	Acousto C/S,SDI 271 
Acousto C/S,SDI 271 	Wave C/S,SDI 255 	Acousto C/S,SDI 271 	Sword C/S,SDI 295 

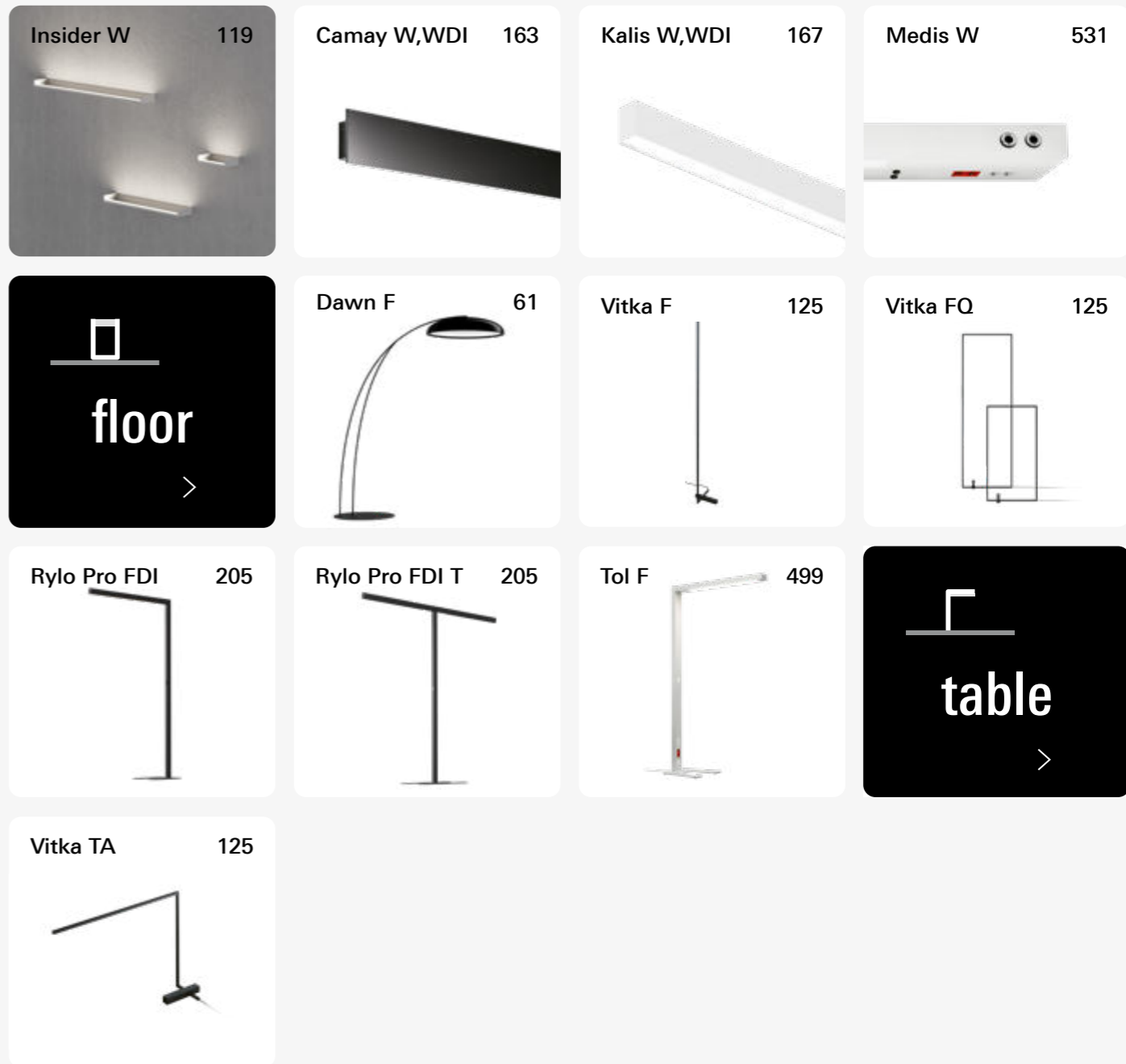
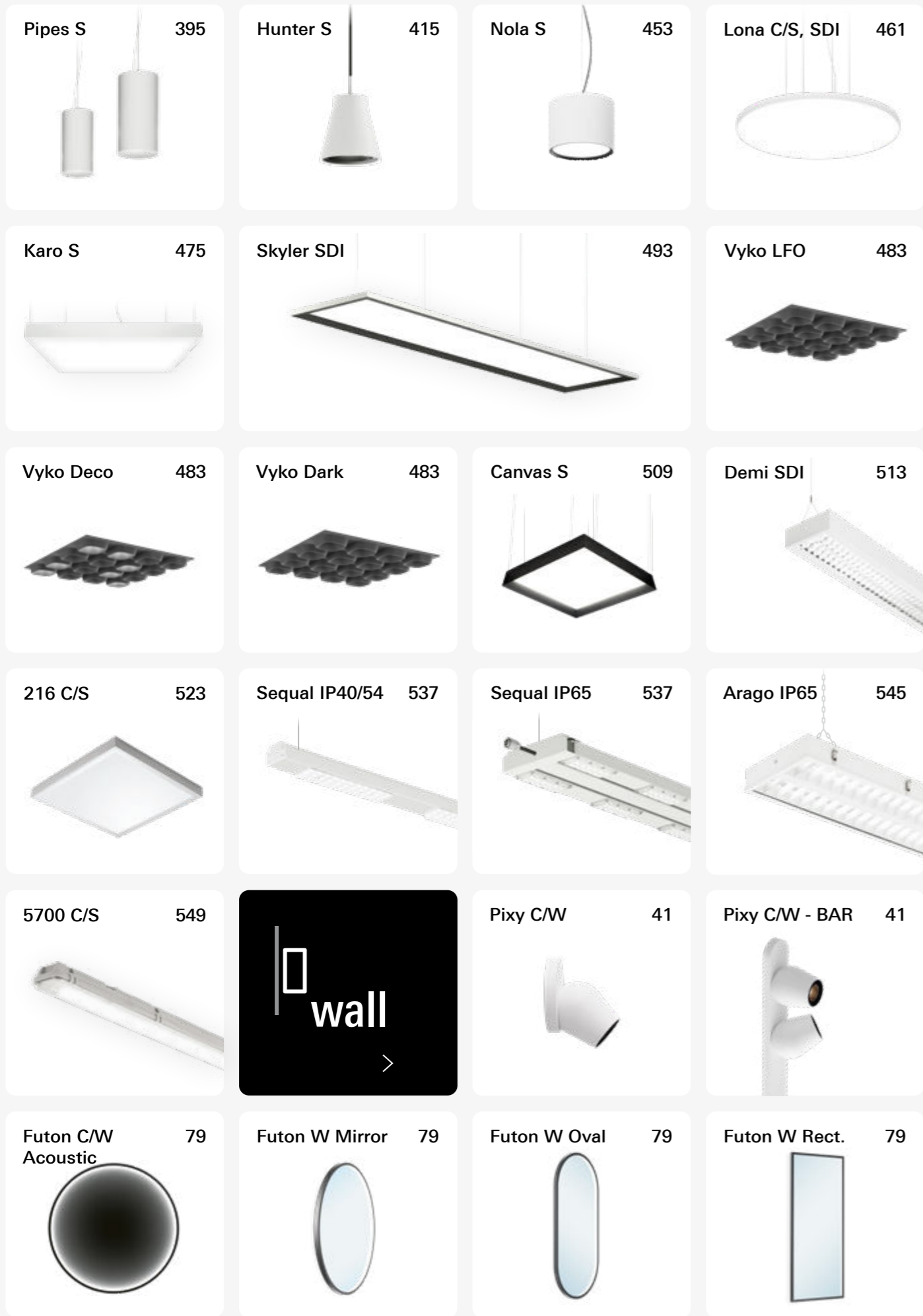



reddot design award
winner



BIGSEE
PRODUCT DESIGN
AWARD
2018



BY CHICAGO ATHENAEUM



Biba

Tiny sophistication

Everybody loves Biba

Individually or in a matching composition, sophistication is the look you get. Think about Biba if you're planning an elegant restaurant, minimalistic hotel lobby, Scandinavian-inspired bar, urban retail experience or even your home dining room and let it suit your taste.

Combine shapes and colours in an endless fusion of possibilities, which will lead you from simple and sophisticated, to a luminaire composition that really lets your ideas fly.

Vsi imajo radi Bibo

Naj bo sama ali v ujemajočih se kombinacijah, bo Biba v prostor vedno vnesla eleganco in prefinjenost. Kombinirajte različne oblike in barve ter jih združite v neskončno fuzijo možnosti, ki vas lahko popeljejo od preprostega in elegantnega do kompozicije, ki vašim idejam daje krila.

Ko smo ustvarjali Bibo, smo si jo zamislili v elegantnih restavracijah, minimalističnih hotelskih lobijih, barih s skandinavskim dizajnom, urbanih prodajalnah in celo v domači jedilnici. Kakšna bo vaša kombinacija?

Svi vole Bibu

Pojedinačno ili u sastavu, dobivate izgled profinjenosti. Razmislite o Bibi ako planirate elegantan restoran, minimalističko hotelsko predvorje, Skandinavijom nadahnuti bar, urbano maloprodajno iskustvo ili čak svoju kućnu blagovaonice koja će odgovarati vašem ukusu.

Kombinirajte oblike i boje u beskonačnoj fuziji mogućnosti koje će vas voditi od jednostavnog i profinjenog, do sastava rasvetnog tijela koje vašim idejama omogućuje da zaista polete.



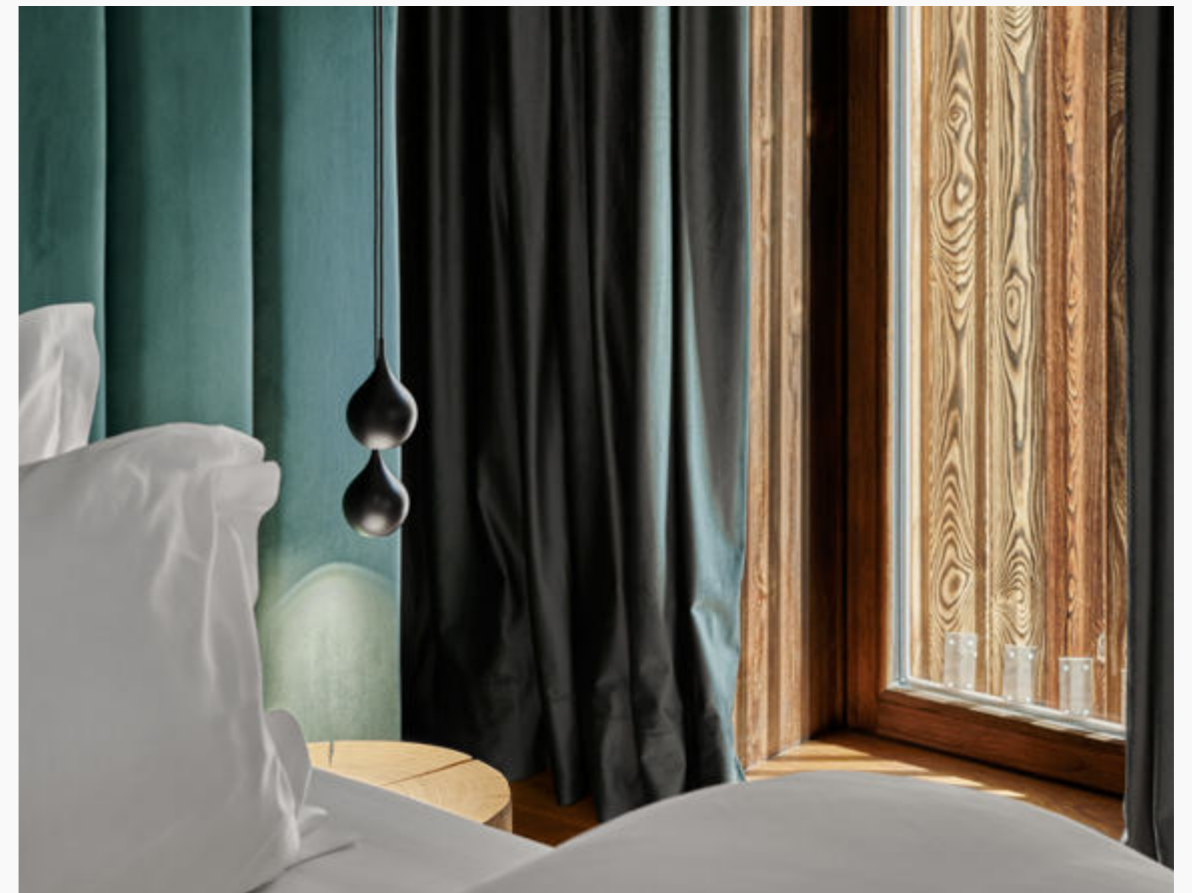



The product has a custom colour.



0,8kg
1,8lb

Due to its weight, the cable is always taut

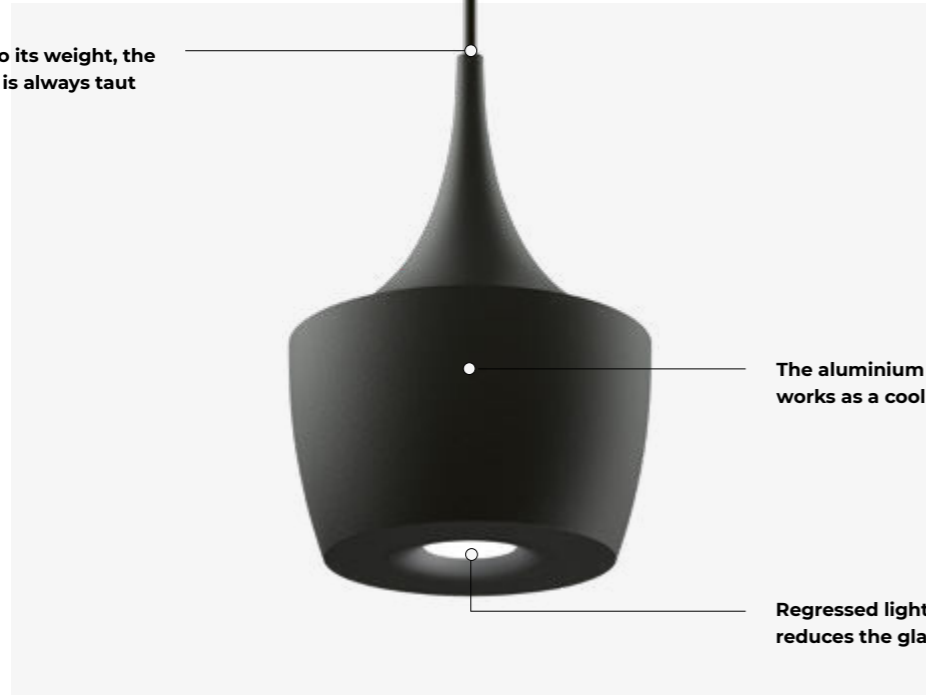

The aluminium body works as a cooling system

Regressed light source reduces the glare

MAIN FEATURES

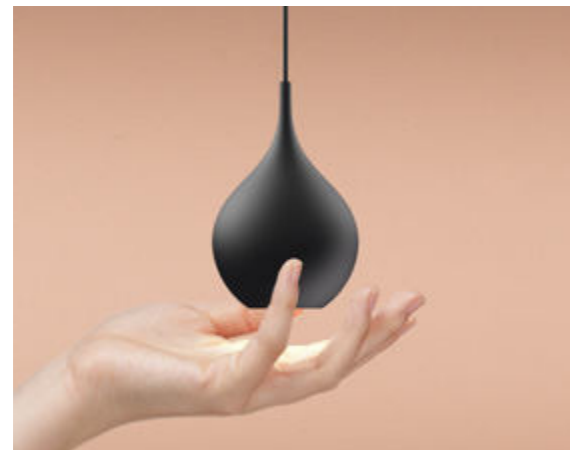

Biba is small

Smaller than you thought. But only by its size, not by its effect. Everyone notices and admires it. Its clean lines and carefully chosen shapes will enhance your space.

Something for your taste

The best stories happen at the table, and Biba loves to be part of that. A regressed light source and installation at the right height will offer high visual comfort with low glare. It will create a great ambient for conversations, and due to a good colour rendering, the food will be even more appetizing.



Create your pattern of shapes and colours

Combining shapes and colours in an endless fusion of possibilities will lead you from simple and sophisticated, to a luminaire that lets your ideas fly.

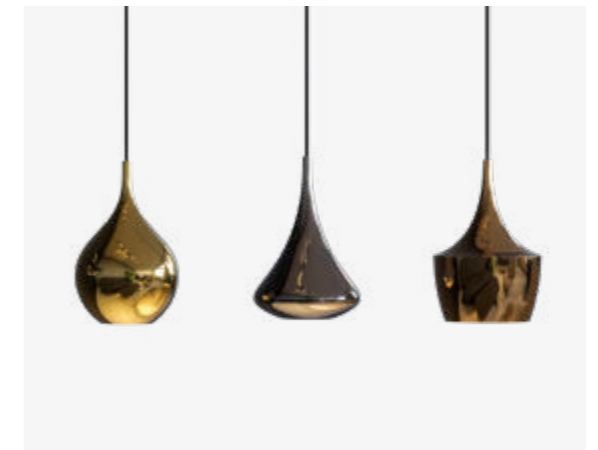

Details that make a difference

Biba is made of single aluminium piece. The transition between the power cable and the luminaire is seamless. Its substantial weight guarantees constant straight tension of the cable and pure aluminium case works as a cooling system for the lighting source.





Cable decentralizer for moving the position of the single luminaire, the cables stay taut.

Cable holder for cables becoming part of the design

MAIN FEATURES



Sometimes one simply isn't enough

Choose a cluster ceiling cup when you want to create a group of products closely together. The driver is integrated in the ceiling cup.



Cluster composition

In the case of a remote power-in position, this can be just a functional feature. But it is suitable also when you want a more dynamic composition and the cables to become part of the design. 3-7 spots can be connected to a cluster.

Biba

Technical Overview



FAMILY MEMBER



TECH. SPECS

LUMINAIRE LUMINOUS FLUX	LED COLOUR	BEAM ANGLE	DRIVER	DRIVER POSITION
520 - 850 lm	927, 930, 935, 940	20°, 30°, 55°	Casambi, DALI, FO	Ceiling cup / Remote

COLOURS

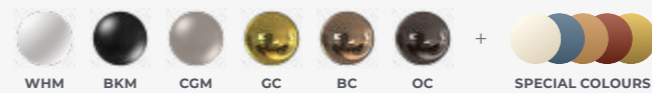

GR1 CASAMBI



Light source: High-power COB LED, CRI>90, MacAdam≤2, 50.000h L90 B10 at 35°C. **Optic:** Highly efficient with uniform distribution, metalized polycarbonate with lacquer finish. **Body:** Aluminium, powder or PVD coated. **Ceiling cup:** Ceiling cup with or without driver must be ordered separately. **Control gear:** Constant current driver - order separately. **Power supply:** 125 - 600 mA.

Svetlobni vir: Visoko učinkovit COB LED modul, CRI>90, barvno odstopanje MacAdam≤2, 50.000 h L90 B10 na 35°C. **Optika:** Visoko učinkovit metaliziran in lakiran polikarbonat z enakomerno porazdelitvijo svetlobnega snopa. **Ohišje:** Aluminij, prašno ali PVD barvano. **Stropna rozeta:** Stropno rozeto z ali brez LED konverterja je treba naročiti ločeno. **Napajalnik:** LED konverter s konstantnim tokom - ločeno naročanje. **Napajanje:** 125 - 600mA.

Izvor svetla: LED COB velike snage, CRI>90, MacAdam≤2, 50.000 h L90 B10 na 35°C. **Optika:** Visoko učinkovit s jednolikom distribucijom, metaliziran polikarbonat sa završnim slojem laka. **Kučište:** Aluminij, praškasto ili PVD plastificiran. **Stropna rozeta:** Stropna rozeta sa ili bez predspojne naprave naručuje se zasebno. **Predspojne naprave:** Predspojna naprava konstantne struje - naručiti zasebno. **Napajanje:** 125 - 600 mA.



Pixy

Authentically magnetic

Move your table. Pixy will follow

Pixy is never fixed. It is always flexible. Which makes it the perfect choice for restaurants and bars where moving tables is a daily routine. With a small carbon rod and a magnet, you can instantly move and redirect the light without using the ladder. We think that Pixy is nicer when grouped. Combine composition over and over again.

Premaknite svojo mizo. Pixy vam bo sledila

Pixy ni nikoli fiksna. Je povsem fleksibilna in kot taka odlična izbira za restavracije in bare, kjer je premikanje miz vsakodnevna rutina. Z majhno karbonsko palico in magnetom lahko svetlobo v trenutku premaknete in preusmerite brez uporabe lestve. Menimo, da je Pixy lepša v kompoziciji, ki jo lahko kar naprej spreminjate.

Pomaknite svoj stol. Pixy će ga pratiti

Pixy nikad nije fiksiran. Uvijek je fleksibilan što ga čini savršenim izborom za restorane i barove u kojima je pomicanje stolova svakodnevna rutina. Pomoću male karbonske šipke i magneta, svjetlo se može odmah premjestiti i preusmjeriti bez korištenja ljestava. Mislimo da je Pixy ljepši u društvu ostalih svjetla. Kombinacije možete prepustiti mašti.









MAIN FEATURES



Step-less orientation

The magnet allows step-less orientation. This gives you freedom when moving and redirecting the light to the desired position. It comes very useful in situations where moving furniture is a daily routine.



Aesthetic solution for concrete ceilings

The driver is integrated into the ceiling cup, so it is appropriate for installing it when you can't have a remote driver. Thanks to the magnets, Pixy can be simply adjusted to the desired direction.

Combine your favourite composition

With cluster installation you can combine up to seven spots. Cables can become part of the design and remote power-in position will no longer be a problem.

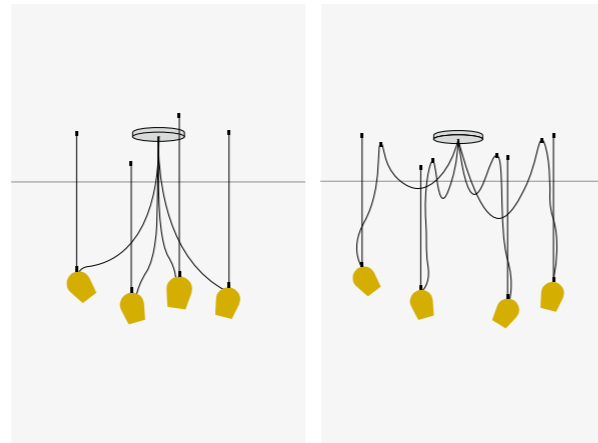

One bar, 3 or 5 spots

Why having many single ceiling cups when you can have only one aesthetic bar with integrated driver? 3 or 5 spots can be flexibly rotated and dimmed.

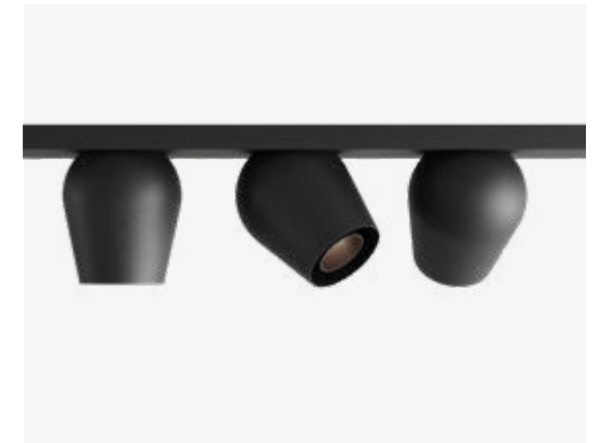

Pixy

Technical Overview



S
Suspended



C/W
Ceiling / Wall



C/W D
Ceiling / Wall with integrated driver



C/W-BAR 3
Ceiling / Wall with integrated driver

C/W-BAR 5
Ceiling / Wall with integrated driver

	S	C/W	C/W D	C/W-BAR 3	C/W-BAR 5
Beam angle	30°, 50°	30°, 50°	30°, 50°	30°, 50°	30°, 50°
Orientation	± 95° / 360°	± 58° / 360°	± 58° / 360°	± 58° / 360°	± 58° / 360°
Luminaire luminous flux	690 - 1550 lm	690 - 1550 lm	690 - 1550 lm	3x 690 - 1550 lm	5x 690 - 1550 lm
LED colour	927, 930, 935, 940	927, 930, 935, 940	927, 930, 935, 940	927, 930, 935, 940	927, 930, 935, 940
Driver	Casambi, DALI, FO	Casambi, DALI, FO	Casambi, DALI, FO	Casambi, DALI, FO	Casambi, DALI, FO
Driver position	Ceiling cup / Remote	Remote	Ceiling cup	Ceiling bar	Ceiling bar
Dimensions	SH (mm): 500 - 2000				

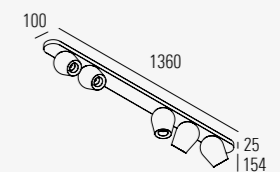
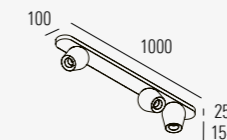
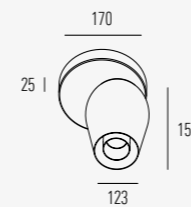
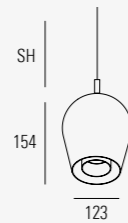

Standard: **B** **D** **A** **C** Special colours:

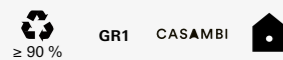

Light source: High-power COB LED, CRI>90, MacAdam≤2, 50.000h L90 B10 at 35°C. **Optic:** Highly efficient with uniform distribution, metalized polycarbonate with lacquer finish. **Body:** Steel-sheet, powder coated. **Ceiling cup:** Ceiling cup with or without driver or ceiling bar with integrated driver must be ordered separately. **Control gear:** Constant current driver (order separately). In the Pixy C Bar integrated highly-efficient driver with fixed output (FO) or dimmable (DALI-TD, Casambi). **Power supply:** 250 - 450mA / 230V 50Hz.

Svetlobni vir: Visoko učinkovit COB LED modul, CRI>90, barvno odstopanje MacAdam≤2, 50.000 h L90 B10 na 35 °C. **Optika:** Visoko učinkovit metaliziran in lakiran polikarbonat z enakomerno porazdelitvijo svetlobnega snopa (srednji, široki svetlobni snop). **Ohišje:** Pločevina, prašno barvana. **Stropna rozeta:** Stropno rozeto ali nosilec z ali brez LED konverterja je treba naročiti ločeno. **Napajalnik:** LED konverter s konstantnim tokom je treba naročiti ločeno. Stropna konzola je opremljena z LED konverterjem s konstantnim tokom (FO) ali regulacijskim izhodom (DALI-TD, Casambi). **Napajanje:** 250 - 450 mA / 230 V 50 Hz.

Izvor svetla: LED COB velike snage, CRI>90, MacAdam≤2, 50.000 h L90 B10 na 35 °C. **Optika:** Visoko učinkovit s jednolikom distribucijom, metaliziran polikarbonat sa završnim slojem laka (srednji, široki). **Kućište:** Dekapirani čelik, elektrostatski plastificiran. **Stropna rozeta:** Stropna rozeta sa ili bez predspojne naprave ili štapna rozeta naručuju se zasebno. **Predspojne naprave:** Predspojna naprava konstantne struje - naručiti zasebno. U Pixy C Bar ugrađena visokoefikasna predspojna naprava konstantnog izlaza (FO) ili dimabilna (DALI, TD ili Casambi) **Napajanje:** 250 - 450 mA / 230 V 50 Hz.



BIGSEE
PRODUCT DESIGN
AWARD
2019



BY CHICAGO ATHENAEUM



Zoe

Light up your creativity

Creative. Unique. Yours.

Mix and match your favourite combination of five different shapes and an on-trend colour palette to create something that fits your wishes like a glove. The finest materials, green technologies and sophisticated production are reflected in top-notch design and give this decorative element a chance to create the ambience of your dreams.

Whether planning a home, a restaurant, a hotel or a store, Zoe finds its place in minimalistic, Scandinavian influenced, urban interiors and turns it into something truly beautiful.

Ustvarjalna. Edinstvena. Vaša.

Zoe ponuja edinstveno priložnost za ustvarjanje svetila po vašem okusu. Kombinirajte različne oblike in barve ter ustvarite svetilo, ki se vašemu prostoru popolnoma prilaga.

To izjemno dizajnersko svetilo je odraz uporabe najboljših materialov, zelenih tehnologij in prefinjene proizvodnje. Vidimo ga v domovih, restavracijah, hotelih in prodajalnah, saj se Zoe odlično prilaga prostorom z minimalističnim, skandinavskim in urbanim značajem.

Kreativno. Jedinostveno. Vaše.

Pomiješajte i uspoedite svoju omiljenu kombinaciju pet različitih oblika i paletu boja u trendu kako biste ostvarili svoje želje. Najbolji materijali, zelene tehnologije i sofisticirana produkcija ogledaju se u vrhunskom dizajnu i daju ovom dekorativnom elementu priliku da stvori ambijent vaših snova.

Bilo da planirate kuću, restoran, hotel ili trgovinu, Zoe pronalazi svoje mjesto u minimalističkim, Skandinavijom nadahnutim i urbanim interijerima i pretvara ih u nešto zaista prelijepo.









MAIN FEATURES



The product has a custom colour.



Prestigious look with golden inner colour

The golden funnel gives the product a prestigious look, and the emitted light seems warmer. With the white interior, you can reach higher lumen output. The third option is the same colour for both interior and exterior.

Creative. Unique. Yours.

Be creative. Mix and match your favourite shapes and trendy colours to create something unique, only yours.





Carefully designed details

Zoe boasts seamless joints either between two shapes but also between the power cable and the luminaire itself.



Always trendy

Clean basic shapes and selected colours are always trendy, no matter the style of your furniture and interior.

Zoe

Technical Overview



FAMILY MEMBER	TECH. SPECS			
	LUMINAIRE LUMINOUS FLUX	LED COLOUR	DRIVER	DRIVER POSITION
<p>230 Ø86 Z7</p>	<p>230 Ø210 Z8</p>	<p>230 Ø210 Z2</p>	<p>230 Ø132 Z1</p>	
<p>345 Ø86 Z3</p>	<p>345 Ø210 Z4</p>	<p>345 Ø210 Z5</p>	<p>345 Ø132 Z6</p>	
	477 - 1481 lm	927, 930, 935, 940	Casambi, DALI, FO	Ceiling cup / Remote
COLOURS				

The inner colour is the same as the bottom part, white or gold.



GRO

CASAMBI



CE



Light source: High-power COB LED, CRI>90, MacAdam≤2, 50.000h L90 B10 at 35°C. **Optic:** Satined prismatic lens dome for uniform light distribution. **Body:** Aluminium, powder coated. **Ceiling cup:** Ceiling cup with or without driver must be ordered separately. **Control gear:** Constant current driver - order separately. **Power supply:** 150 - 350mA / 230V 50Hz.

Svetlobni vir: Visoko učinkovit COB LED modul, CRI>90, barvno odstopanje MacAdam≤2, 50.000 h L90 B10 na 35 °C. **Optika:** Satinirana prizmatična kupola za enakomerno osvetlitev. **Ohišje:** Aluminij, prašno barvan. **Stropna rozeta:** Stropno rozeto z ali brez LED konverterja je treba naročiti ločeno. **Napajalnik:** LED konverter s konstantnim tokom - ločeno naročanje. **Napajanje:** 150 - 350 mA / 230 V 50 Hz.

Izvor svetla: LED COB velike snage, CRI>90, MacAdam≤2, 50.000 h L90 B10 na 35 °C. **Optika:** Satinirana prizmatična kupola za ravnomjerno osvijetljenost. **Kućište:** Alumijsko, elektrostatski plastificirano. **Stropna rozeta:** Stropna rozeta sa ili bez predspojne naprave naručuje se zasebno. **Predspojne naprave:** Predspojna naprava konstantne struje - naručiti zasebno. **Napajanje:** 150 - 350 mA / 230 V 50 Hz.



BY CHICAGO ATHENAEUM



red dot design award winner



GOOD DESIGN AWARD TOKYO



Dawn

Morning light

Turning dark to dawn one light at a time

Dawn is the perfect luminaire for all romantics who love soft early morning light. Unlike other luminaires which have their light source located in the centre, Dawn hides its source behind the edge and only reveals soft uniform illumination, comparable to the morning dawn.

Dawn boasts elegant details such as a single piece frame, delicate edge design and 100% clean interior, with no visible elements. It's a luminaire that pays attention to the details by turning a power cable to an eye-catching element and it's a perfect example of how to elevate a standard decorative product to a unique lighting experience.

Iz teme v jutranjo zarjo

Svetilo Dawn je popolna izbira za vse romantike, ki obožujejo mehko svetlobo zgodnjega jutra. Za razliko od svetil, ki imajo vir svetlobe na sredini, Dawn svojega skriva pod zunanjim robom, kar zagotavlja prijetno enakomerno razpršeno svetlobo, primerljivo z jutranjo zarjo.

Dovršena izdelava se izraža v njegovem elegantnem videzu in popolnoma čisti notranjosti, saj v svetilu Dawn ne boste našli nobenega vidnega elementa. Je svetilo, ki veliko pozornost posveča podrobnostim in bolj kot katero koli prej dokazuje, da je dekorativni izdelek resnično mogoče spremeniti v edinstveno doživetje, ki ga je težko posnemati.

Pretvara mrak u zoru

Dawn je savršeno rasvetno tijelo za sve romantičare koji vole mekano ranojutarnje svjetlo. Za razliku od drugih rasvetnih tijela kojima se izvor svjetla nalazi u središtu rasvetnog tijela, Dawn svoj izvor skriva ispod ruba i otkriva samo blago ujednačeno osvjetljenje, usporedivo s jutarnjom zorom.

Dawn se može pohvaliti elegantnim detaljima poput jednodijelnog okvira, ruba osjetljivog dizajna i 100% čistog interijera, bez vidljivih elemenata. Ovo je rasvetno tijelo koje pridaje pažnju detaljima tako što strujni kabel pretvara u oku ugodan element i savršen je primjer kako pretvoriti standardni dekorativni proizvod u jedinstveno rasvetno iskustvo.







The product has a custom colour.



The product has a custom colour.



MAIN FEATURES



Made from a single piece

There are no joints. Dawn is made out of a single piece of aluminium which makes its surface even smoother, more uniform and sophisticated.

Soft diffused light without a diffuser

Dawn reveals a soft, uniform and reflected light with no hard shadows and contrasts.

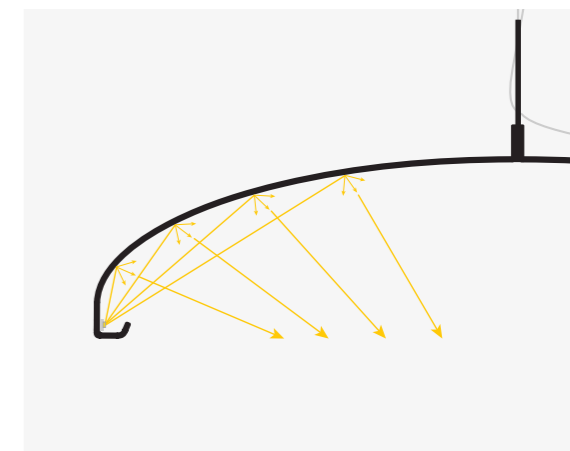

Dawn

Technical Overview

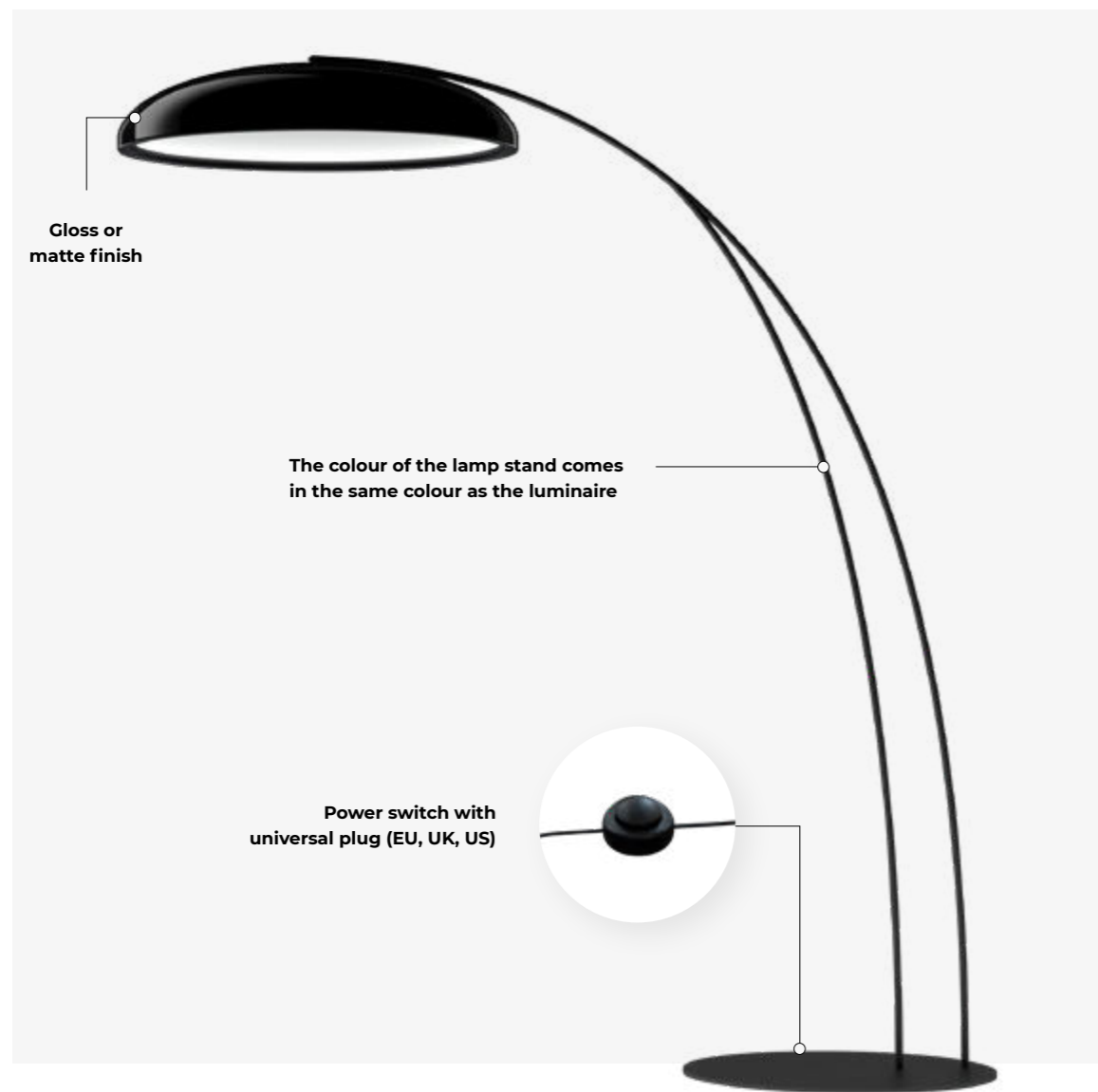

S
Suspended

F
Floor*

	S Suspended	F Floor*
Luminaire luminous flux		
Ø600	1700 lm	-
Ø800	2250 lm	2250 lm
Ø1000	3000 lm	-
Light distribution	Soft diffused light	Soft diffused light
LED colour	927, 930, 935, 940	927, 930, 935, 940
Driver	Casambi, DALI, FO	Push dimm
Driver position	Ceiling cup / Remote	Integrated on universal plug
Dimension	DxH (mm): 616x132, 807x173, 1062x220 SH (mm): 1500, 3000, 5000	

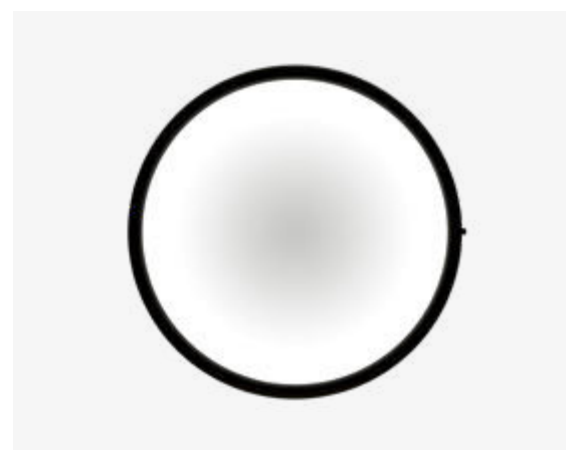
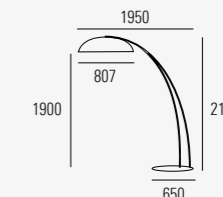
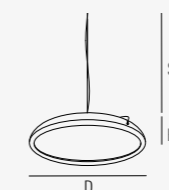

100% clean interior

As the light source is completely hidden under the edge, the interior of the luminaire is clean, with no screws or suspensions.

The Dawn F base is always in structural black colour.

Standard: **B** **D** **A** **C** Special colours:



Light source: High-flux LED strip, CRI>90, MacAdam≤2, 50000h L90 B10 at 35°C. **Optic:** Perimetric indirect light system with gradient. **Body:** Aluminium, powder coated. **Ceiling cup:** Ceiling cup with or without driver must be ordered separately. **Control gear:** Constant voltage driver - order separately. **Power supply:** 24V DC.

Svetlobni vir: Visoko svetilen LED trak, CRI>90, barvno odstopanje MacAdam≤2, 50.000 h L90 B10 na 35 °C. **Optika:** Perimetrični indirektni svetlobni sistem z gradientom. **Ohišje:** Aluminij, prašno barvan. **Stropna rozeta:** Stropno rozeto z ali brez LED konverterja je treba naročiti ločeno. **Napajalnik:** LED konverter s konstantno napetostjo - ločeno naročanje. **Napajanje:** 24 V DC.

Izvor svetla: LED traka velikog svetlosnog toka, CRI>90, MacAdam≤2, 50.000 h L90 B10 na 35 °C. **Optika:** Perimetrični indirektni svetlosni sistem s gradijentom. **Kućište:** Aluminijско, elektrostatski plastificirano. **Stropna rozeta:** Stropna rozeta sa ili bez predspojne naprave naručuje se zasebno. **Predspojne naprave:** Predspojna naprava konstatnog napona naručiti zasebno. **Napajanje:** 24 V DC.

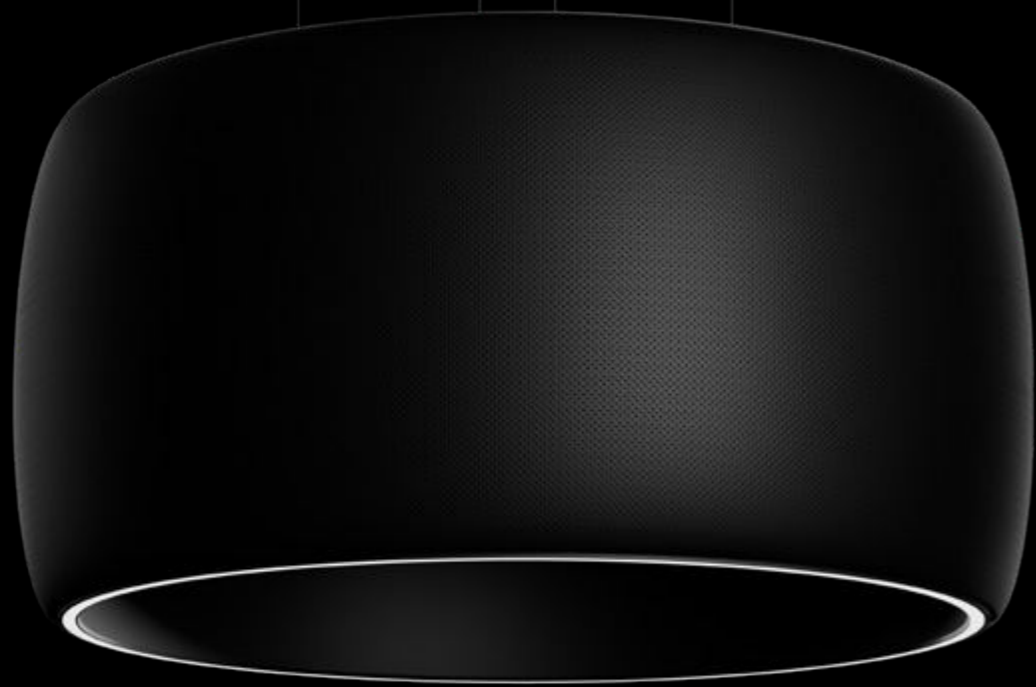

Black Hole

Extreme phenomenon

Its perfection absorbs you

This is a story of how the light found the way out of the black hole to enlighten your space. Black hole is a perfect luminaire for all your galaxies – home, office, hospitality. Because of its size and distinct look it has absolutely no chance to stay invisible.

It is multifunctional. It offers different possibilities of illumination. The acoustic surface reduces noise and improves speech audibility. With its integrated Bluetooth loudspeaker, you can listen to your favourite music, and its sophisticated design brings a touch of luxury to your space. Last but not least, the atmosphere it creates might help you find the way out whenever you feel stuck in a black hole.

Njena popolnost vas posrka

To je zgodba o tem, kako je svetloba našla pot iz črne luknje in razsvetlila vaš prostor. Črna luknja je popolna svetilka za vse vaše galaksije – dom, pisarno, gostinstvo. Zaradi svoje velikosti in izrazitega videza jo je nemogoče prezreti.

Je večnamenska. Ponuja različne možnosti osvetlitve. Akustična površina zmanjšuje hrup in izboljšuje slišnost govora. Preko vgrajenega zvočnika s tehnologijo Bluetooth lahko poslušate svojo najljubšo glasbo, njena elegantna oblika pa v vaš prostor vselej vnese pridih razkošja. Nenazadnje, vzdušje, ki ga ustvarja, vam lahko pomaga najti izhod, ko se počutite, kot da ste obtičali v črni luknji.

Njezino savršenstvo vas upija

Ovo je priča o tome kako je svjetlost pronašla izlaz iz crne rupe kako bi osvijetlila vaš prostor. Black hole (»crna rupa«) je savršeno svjetlo za sve vaše galaksije – dom, ured, ugostiteljstvo. Zbog svoje veličine i upadljivog izgleda, Black hole nema apsolutno nikakve šanse da ostane nezamijećen.

Ovo svjetlo je višenamjensko, s različitim mogućnostima osvjetljenja. Akustična površina smanjuje šum i poboljšava čujnost govora. S integriranim Bluetooth zvučnikom možete slušati svoju omiljenu glazbu, a njegov sofisticirani dizajn unosi dašak luksuza u vaš prostor. Također, svojom atmosferom pomaže Vam pronaći izlaz kad god se osjećate kao da ste zaglavljani u crnoj rupi.







MAIN FEATURES



A touch of luxury

Black Hole is different from other luminaires even at a glance, always adding a touch of luxury to the space. Its soft round form is ageless.

Noise reduction

The noise level in a space has an impact on the well-being. The big acoustic surface of Black Hole reduces the noise pollution in the space and improves the acoustics.

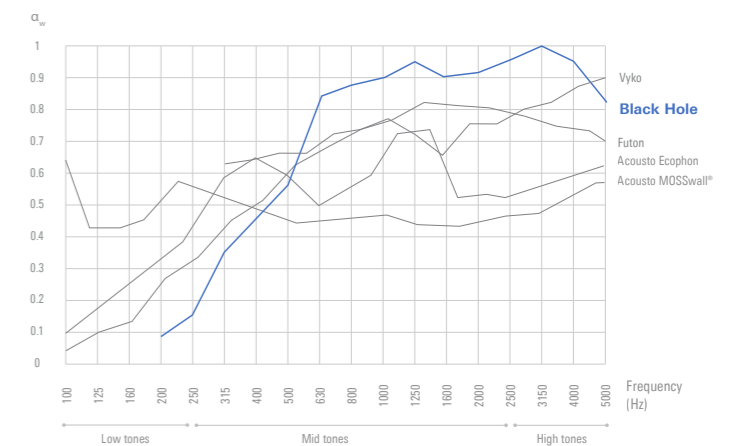

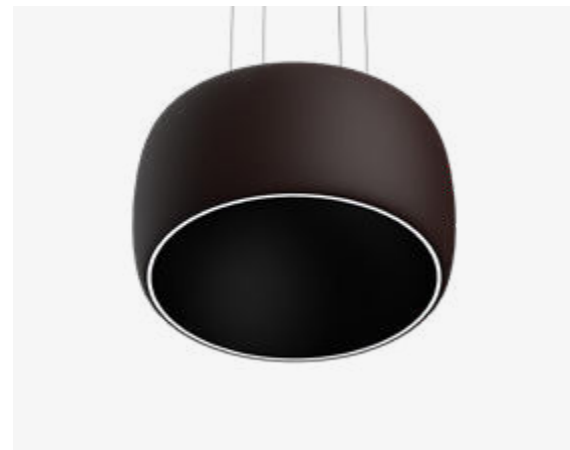

Dome-shaped black interior

It creates the essence of Black Hole, where you lose the sense of the product deepness. Direct / indirect illumination can be switched or dimmed separately, making this luminaire a perfect fit for your changing needs.



Bluetooth Sound System

With the use of wireless BlueTooth technology, you can connect smartphones, computers, or tablets and enjoy your favourite music with a built-in speakers system.

FEATURES:

Output power: 4x30W | Peak power: 4x50W | Dynamic frequency response range: 100 Hz - 15000 Hz +/- 3 dB, 80 Hz - 20000 Hz +/- 5 dB | Bluetooth version: 5.1

Black Hole

Technical Overview



FAMILY MEMBER

416



840

TECH. SPECS

LUMINAIRE LUMINOUS FLUX	LIGHT DISTRIBUTION	LED COLOUR	DRIVER
4400 - 4800 lm	Direct 50% / Indirect 50%	927, 930, 940	Casambi, DALI, TD
MATERIAL	SOUND ABSORBING SURFACE	SUSPENSION HEIGHT	
Perforated eco leather	1 m ²	1500, 3000, 5000 mm	

MATERIALS



Light source: High-flux LED strip, CRI>90, MacAdam≤2, 50000h L90 B10 at 35°C. **Optic:** Satin opal polycarbonate diffuser (SOP). **Body:** Aluminium dome, powder coated, with faux leather upholstery. **Ceiling cup:** For suspended versions, the ceiling cup and suspension set must be ordered separately. Find out more on the technical pages or online product configurator. **Control gear:** Integrated highly-efficient driver with fixed output (FO-DS) or dimmable (DALI-DS, TD, Casambi) - separate switching. **Power supply:** 230V 50Hz.

Svetlobni vir: Visoko svetlen LED trak, CRI>90, barvno odstopanje MacAdam≤2, 50.000 h L90 B10 na 35 °C. **Optika:** Satinirani opalni polikarbonatni difuzor (SOP). **Ohišje:** Aluminijasta kupola, prašno barvana. Obod iz umetnega usnja. **Stropna rozeta:** Za viseče verzije se rozete in vešala naročajo posebej. Več na straneh s tehnično vsebino ali v spletnem konfiguratorju. **Napajalnik:** Integriran visoko učinkoviti LED konverter s konstantnim tokom (FO-DS) ali regulacijskim izhodom (DALI-DS, TD, Casambi) - ločeno prižiganje. **Napajanje:** 230 V 50 Hz.

Izvor svetla: LED traka velikog svjetlosnog toka, CRI>90, MacAdam≤2, 50.000 h L90 B10 na 35°C. **Optika:** Satinirani opalni polikarbonatni difuzor (SOP). **Kućište:** Aluminijaska kupola, praškasto plastificirana, obučena u umjetnu kožu. **Stropna rozeta:** Za ovjesne inačice, stropna rozeta i ovjesni pribor moraju biti naručeni zasebno. Otkrij više na tehničkim stranicama ili online konfiguratoru proizvođača. **Predspojne naprave:** Integrirana visoko efikasna predspojna naprava konstantnog izlaza (FO-DS) ili dimabilna (DALI-DS, TD, Casambi). Odvojeno paljenje. **Napajanje:** 230 V 50 Hz.



Futon

Circles of light

Acoustic. Mirror. O.
Three versions of thin elegance.

Futon comes in three versions. All different all multipurpose.

Futon Acoustic is perfect when you want to combine unique ambient lighting, functionality of acoustics and trendy colours. Futon O, a shining ring, makes your walls shine in a different way, while Futon Mirror is a mirror and a lamp all-in-one. Alone or in a creative composition, Futon gives its best.

Acoustic. Mirror. O. Tri različice prefinjene elegancije.

Futon je na voljo v treh različicah. Vse drugačne, vse edinstvene, vse večnamenske.

Futon Acoustic je prava izbira, ko želite kombinirati ambientalno svetlobo s funkcionalnostjo akustičnega absorberja in modnimi barvami. Futon O je sijoč obroč, s katerim bo vaša stena zasijala na različne načine. Futon Mirror pa je svetilka in ogledalo v enem. Futon vedno dobro izpade. Najsibo samostojno najsibo v domiselnih kombinacijah.

Acoustic. Mirror. O. Tri verzije tanke elegancije.

Futon se proizvodi u tri verzije. Svaka različita, svaka edinstvena, svaka višenamjenska.

Futon Acoustic je savršen izbor kada želite kombinirati jedinstveno ambientalno osvjetljenje, akustičku funkcionalnost i moderne boje. Futon O, svijetleći prsten, obasjava zidove na poseban način, dok je Futon Mirror ujedno i ogledalo i lampa. Sam, ili kao dio kreativne kompozicije, Futon pruža ono najbolje.



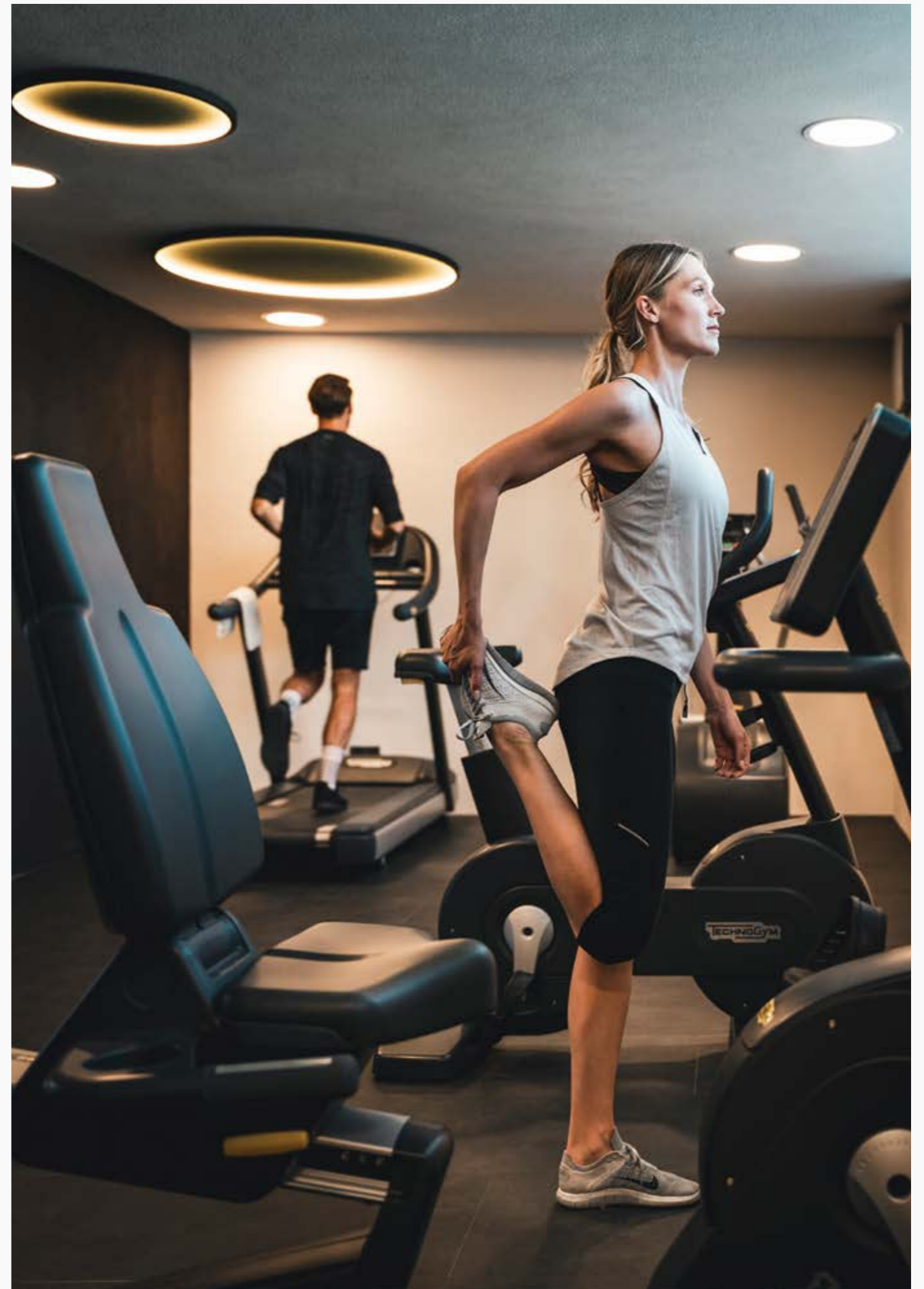







Make it double for a double effect

There will be no acoustic trouble if you choose Futon double. One suspension, but double acoustic fibre or opal diffuser, double light source (on both sides) and most of all double effect.



MAIN FEATURES

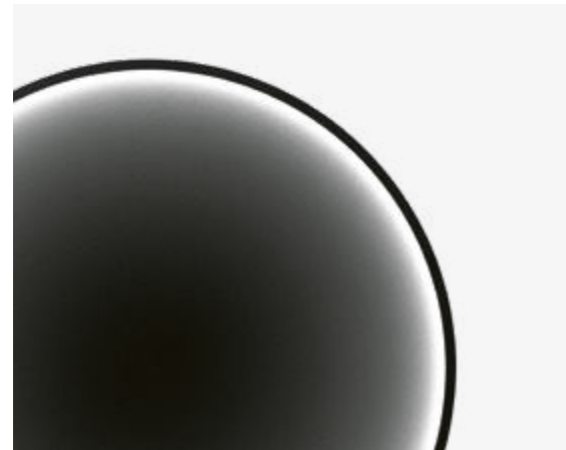

Rich in light effect

The hidden light source illuminates the sound absorbing acoustic panel from the inner edge. Subsiding evenly, it creates a rich glow effect on the fabric.



A mirror? A lamp? Both!

Futon Mirror is a mirror and a lamp all-in-one. The lateral light will illuminate your face and clothes in the best way without any shadows or colour deviations.

Maximum acoustic comfort

Futon enables effective soundproofing and sound absorbing in all areas with higher frequencies.

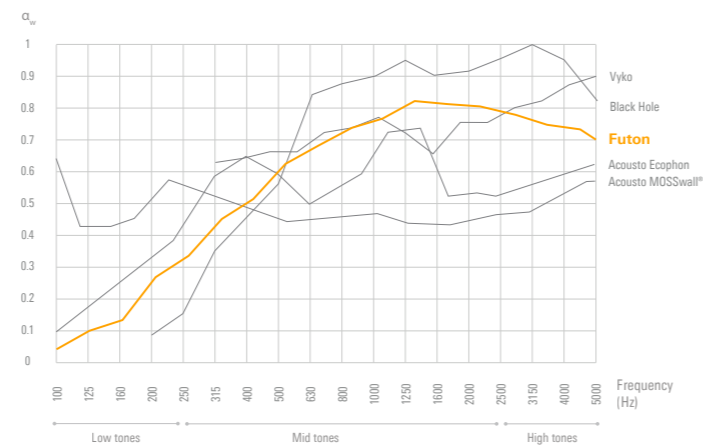
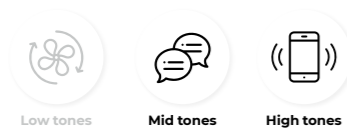

No steam on the mirror surface

This version of Futon is ideal for bathrooms, especially those with inadequate ventilation. A special mirror demister warms up the mirror at 30-35°C, a perfect temperature to prevent the mirror surface from the condensation of steam.



Futon

Technical Overview



S
Suspended



C/W
Ceiling / Wall

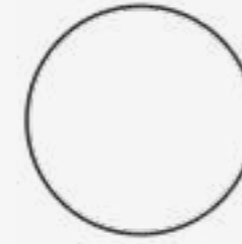

Acoustic

SD Acoustic Suspended double

SD Acoustic Suspended double

O

Mirror Round With or without a heater

Mirror Oval With or without a heater

Mirror Rectangular With or without a heater

Luminaire luminous flux	510 - 1450 lm	1000 - 1400 lm	1000 - 1400 lm	1010 - 2215 lm	1650 - 2650 lm	2700 - 2950 lm	2550 - 3900 lm
Optic	SOP	SOP	SOP	SOP	SOP	SOP	SOP
LED colour	927, 930, 940	927, 930, 940	927, 930, 940	927, 930, 935, 940	927, 930, 940	927, 930, 940	927, 930, 940
Driver	Casambi, DALI, FO	Casambi, DALI, FO	Casambi, DALI, FO	Casambi, DALI, FO	Casambi, DALI, FO	Casambi, DALI, FO	Casambi, DALI, FO
Driver position	Remote	Ceiling cup / Remote	Ceiling cup / Remote	Ceiling cup / Remote	Remote	Remote	Remote
Material	RecycLED ISOPET acoustic panel	RecycLED ISOPET acoustic panel	SOP (Satin opal diffuser)	-	Mirror	Mirror	Mirror
IP Protection	IP40	IP40	IP40	IP40	IP44	IP44	IP44
Sound absorbing surface	0,6 / 2,4 m ² (S), 0,3 / 1,2 m ² (C/W)	0,6	-	-	-	-	-
Colour	B D J	B D J	B D J	B D J	B D H F Y	B D H F Y	B D H F Y
Textile colour			-	-	-	-	-

Dimensions

D (mm): 611, 1216
SH (mm): 1500, 3000, 5000

D (mm): 611
SH Rod (mm): 500 - 2000
SH Suspension set (mm): 1500, 3000, 5000

D (mm): 611
SH Rod (mm): 500 - 2000
SH Suspension set (mm): 1500, 3000, 5000

D (mm): 611, 1216
SH Suspension set (mm): 1500, 3000, 5000

D (mm): 611, 900

H (mm): 906, 1506

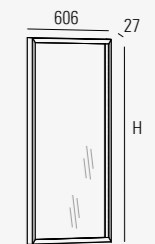
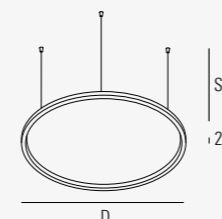
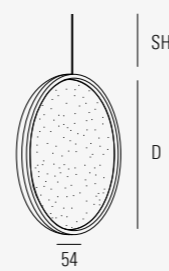
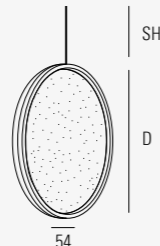
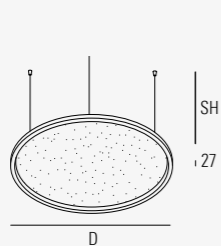

Light source: High-flux LED strip, CRI>90, MacAdam≤2, 50000h L90 B10 at 35°C.
Optic: Satin opal polycarbonate diffuser (SOP). **Body:** Extruded aluminium profile, powder coated with acoustic panel or satin opal diffuser or mirror plate. **Ceiling cup:** Ceiling cup with or without driver must be ordered separately. **Control gear:** Constant voltage driver - order separately. **Power supply:** 24V DC.

Svetlobni vir: Visoko svetilen LED trak, CRI>90, barvno odstopanje MacAdam≤2, 50.000 h L90 B10 na 35 °C. **Optika:** Satiniran opalni polikarbonatni difuzor (SOP). **Ohišje:** Ekstrudiran profil iz aluminija, prašno barvan s centralno ploščo iz akustičnega materiala, satiniranega opalnega difuzorja ali z zrcalom. **Stropna rozeta:** Stropno rozeto z ali brez LED konverterja je treba naročiti ločeno. **Napajalnik:** LED konverter s konstantno napetostjo - ločeno naročanje. **Napajanje:** 24 V DC.

Izvor svetla: LED traka velikog svetlosnog toka, CRI>90, MacAdam≤2, 50.000 h L90 B10 na 35 °C. **Optika:** Satinirani opalni polikarbonatni difuzor (SOP). **Kućište:** Ekstrudirani aluminijški profil, elektrostatski plastificiran, s akustičnim panelom, opalnim difuzorom ili ogledalom **Stropna rozeta:** Stropna rozeta sa ili bez predspojne naprave naručuje se zasebno. **Predspojne naprave:** Predspojna naprava konstatnog napona- naručiti zasebno. **Napajanje:** 24 V DC.

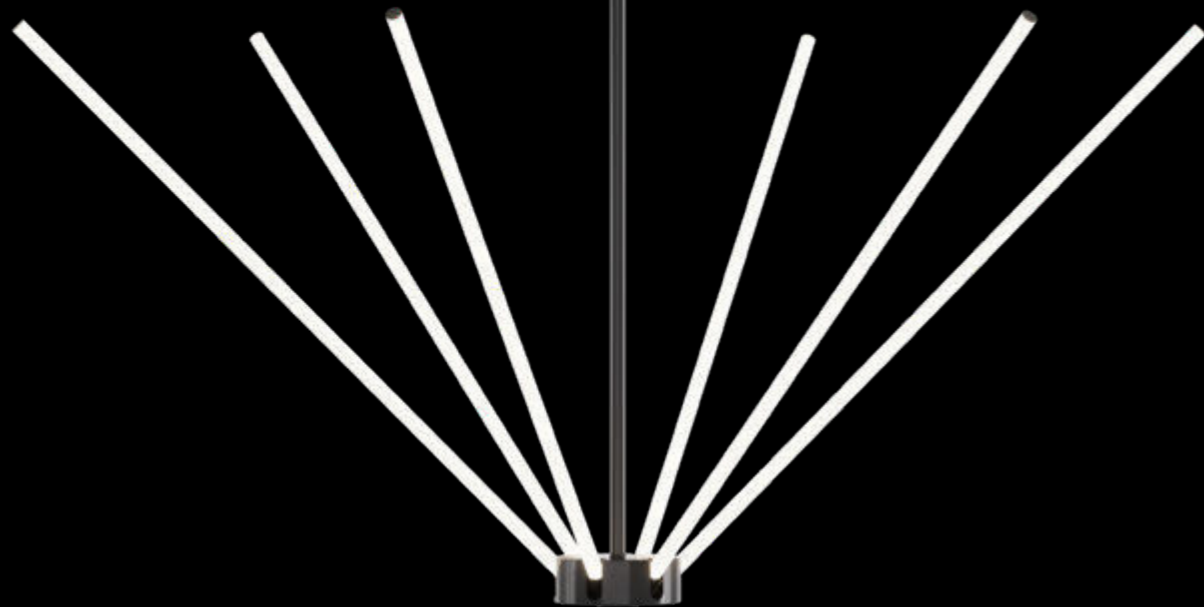

Lysabel

A saber of light

Finally, you can have the lightsaber you always wanted

Lysabel will always bring a touch of sophistication to your space, whether vertical, horizontal, inclined, single or grouped in different creative compositions. It is a slender homogeneously lit tube without shadows. Its look is clean, minimalistic and refined, with every last detail carefully crafted. Looks fragile, but it's not. Its force is versatile – for the power of light and of appearance.

Konačno si lahko priskrbite svetlobni meč, ki ste si ga vedno želeli

Lysabel bo v vaš prostor vedno prinesla kanček prefinjenosti, naj bo v navpični, vodoravni, nagnjeni postavitvi, samostojna ali v različnih kreativnih kompozicijah. Je vitka homogeno osvetljena cev brez senc. Njen videz je čist, minimalističen in prefinjen ter vključuje skrbno oblikovane detajle. Izgleda krhka, vendar ni. Zaradi svetlobe in videza je njena moč vsestranska.

Konačno možete imati svetlosni mač kakav ste oduvijek željeli

Lysabel će uvijek unijeti dašak sofisticiranosti u vaš prostor, bilo okomito, horizontalno, pod kutem, pojedinačno ili grupirano u različite kreativne kompozicije. To je vitka, homogeno osvijetljena cijev bez sjena čistog, minimalističkog i profinjenog izgleda, s pažljivo izrađenim i najsitnijim detaljima. Prividno je krhkog izgleda. Njezinu svestranu snagu odlikuje snažna svjetlost i privlačan izgled.





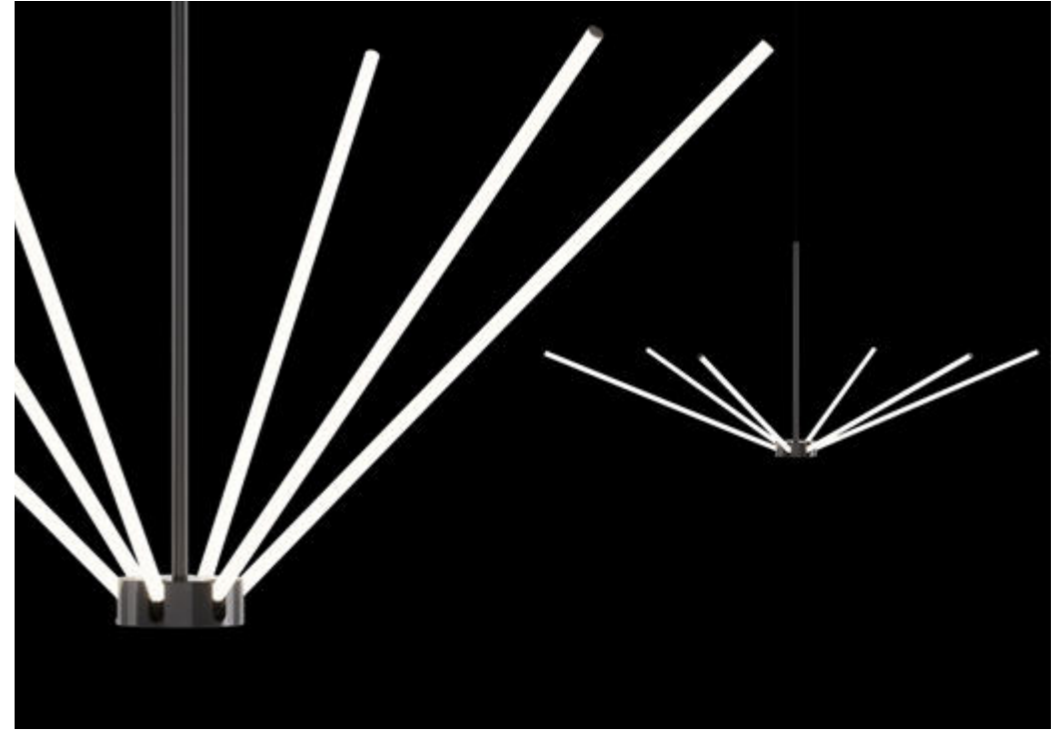

**One product,
different looks**

The different inclination of single tubes totally changes the product's appearance. Set it the way you like it, and change it over time. It will be like having a new luminaire.



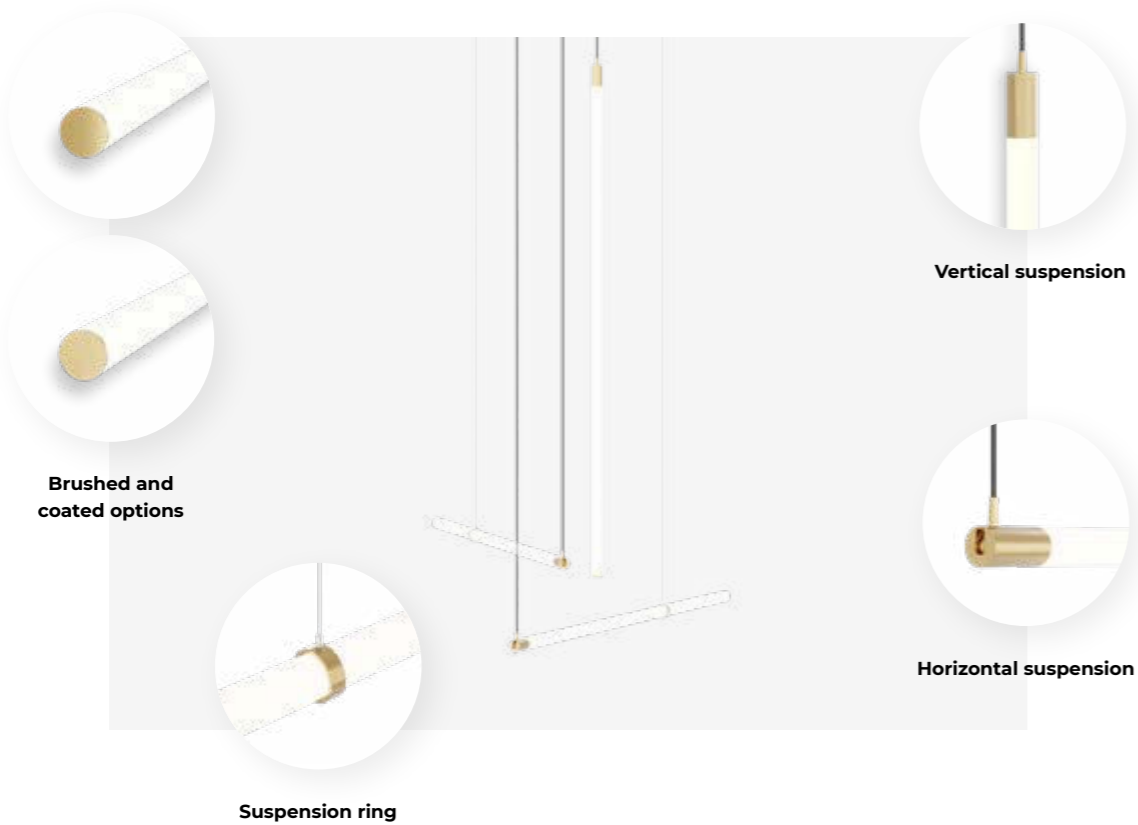

MAIN FEATURES

Always slim in different lengths

Lysabel is available in different sizes. Combine them and create elegant compositions.

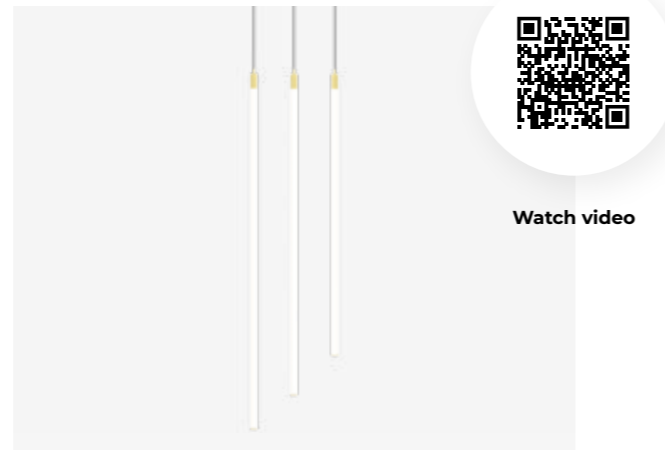

Watch video

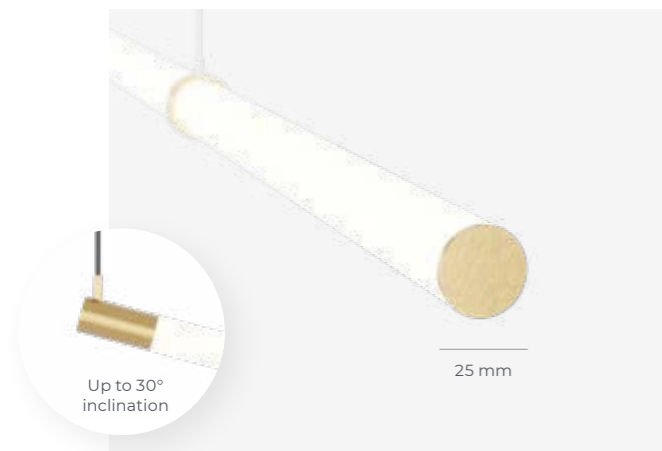

It is also beautiful in horizontally

It can be wholly horizontal or a little inclined with a simple suspension ring. The ring also functions as an aesthetic accessory.

Lysabel

Technical Overview



	S V Suspended vertical	S H Suspended horizontal	S C Suspended chandelier
Luminaire luminous flux	565 - 2565 lm 1850 lm/m	565 - 2565 lm 1850 lm/m	568 - 1261 lm 1850 lm/m (one stick)
Optic	SOP	SOP	SOP
LED colour	927, 930, 935, 940	927, 930, 935, 940	927, 930, 935, 940
Driver	Casambi, DALI, FO	Casambi, DALI, FO	Casambi, DALI, FO
Driver position	Ceiling cup, remote	Ceiling cup, remote	Ceiling cup, remote
Colour finish	H F Y M R W	H F Y M R W	H F Y M R W
Dimensions	L (mm): 660 - 2460 SH (mm): 1500, 3000, 5000	L (mm): 960, 1260 SH (mm): 1500, 3000, 5000	L (mm): 568 - 1261 SH (mm): 1500, 3000, 5000

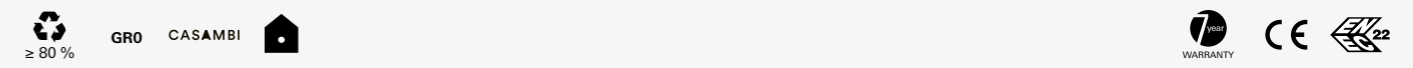
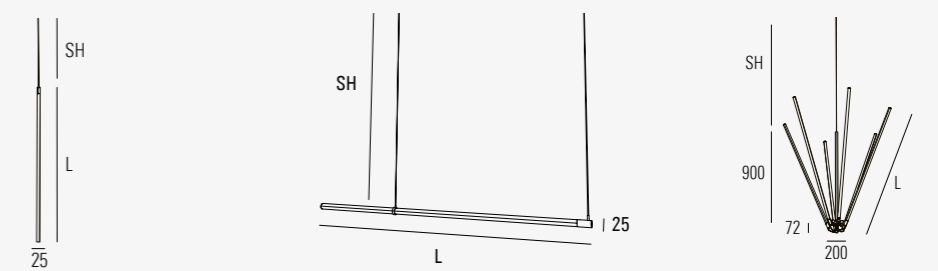

Light source: High-flux LED strip, CRI>90, MacAdam≤2, 50.000h L90 B10 at 35°C. **Optic:** Satin opal polycarbonate diffuser (SOP). **Body:** Aluminium, powder or PVD coated. **Ceiling cup:** Ceiling cup with or without driver must be ordered separately. **Control gear:** Constant voltage driver - order separately. **Power supply:** 24V DC.

Svetlobni vir: Visoko svetilen LED trak, CRI>90, barvno odstopanje MacAdam≤2, 50.000 h L90 B10 na 35 °C. **Optika:** Satinirani opalni polikarbonatni difuzor (SOP). **Ohišje:** Aluminij, prašno ali PVD barvano. **Stropna rozeta:** Stropno rozeto z ali brez LED konverterja je potrebno naročiti ločeno. **Napajalnik:** LED konverter s konstantno napetostjo - ločeno naročanje. **Napajanje:** 24 V DC.

Izvor svetla: LED traka velikog svetlosnog toka, CRI>90, MacAdam≤2, 50.000 h L70 B10. **Optika:** Satinirani opalni polikarbonatni difuzor (SOP). **Kućište:** Aluminij, praškasto ili PVD plastificiran. **Stropna rozeta:** Stropna rozeta sa ili bez predspojne naprave naručuje se zasebno. **Predspojne naprave:** Predspojna naprava konstatnog napona- naručiti zasebno. **Napajanje:** 24 V DC.



Issa

Miss impact

Big open spaces deserve to be arranged with style

Issa is an opal tube that shines along the entire length. One diameter and a variety of sizes allow lots of creativity in compositions.

It brings a general illumination to big open spaces, staircases and halls, with a touch of elegance. Due to its smooth milky surface and important size it stands out like a decorative element also when off.

Veliki odprti prostori si zaslužijo, da jih uredimo s slogom

Issa je opalna cev, ki sije po celotni dolžini. Enoten premer in različne velikosti omogočajo veliko ustvarjalnosti pri kompozicijah.

Primerne je za splošno osvetlitev velikih odprtih prostorov, stopnišč in hodnikov s pridihom elegancije. Zaradi gladke mlečne površine in velikosti izstopa kot dekorativni element, tudi ko ni prižgana.

Veliki otvoreni prostori zaslužuju uređenje sa stilom

Issa je opalna cijev čijom se čitavom dužinom razlikuje svjetlost. Jedan promjer i različite veličine cijevi omogućuju puno kreativnosti u kompozicijama.

Issa je namijenjena za opću rasvjetu u velikim otvorenim prostorima, stubištim i hodnicima, no nosi i dašak elegancije. Zbog svoje glatke površine i iznimne veličine uočljiva je kao dekorativni element i kada je isključena.





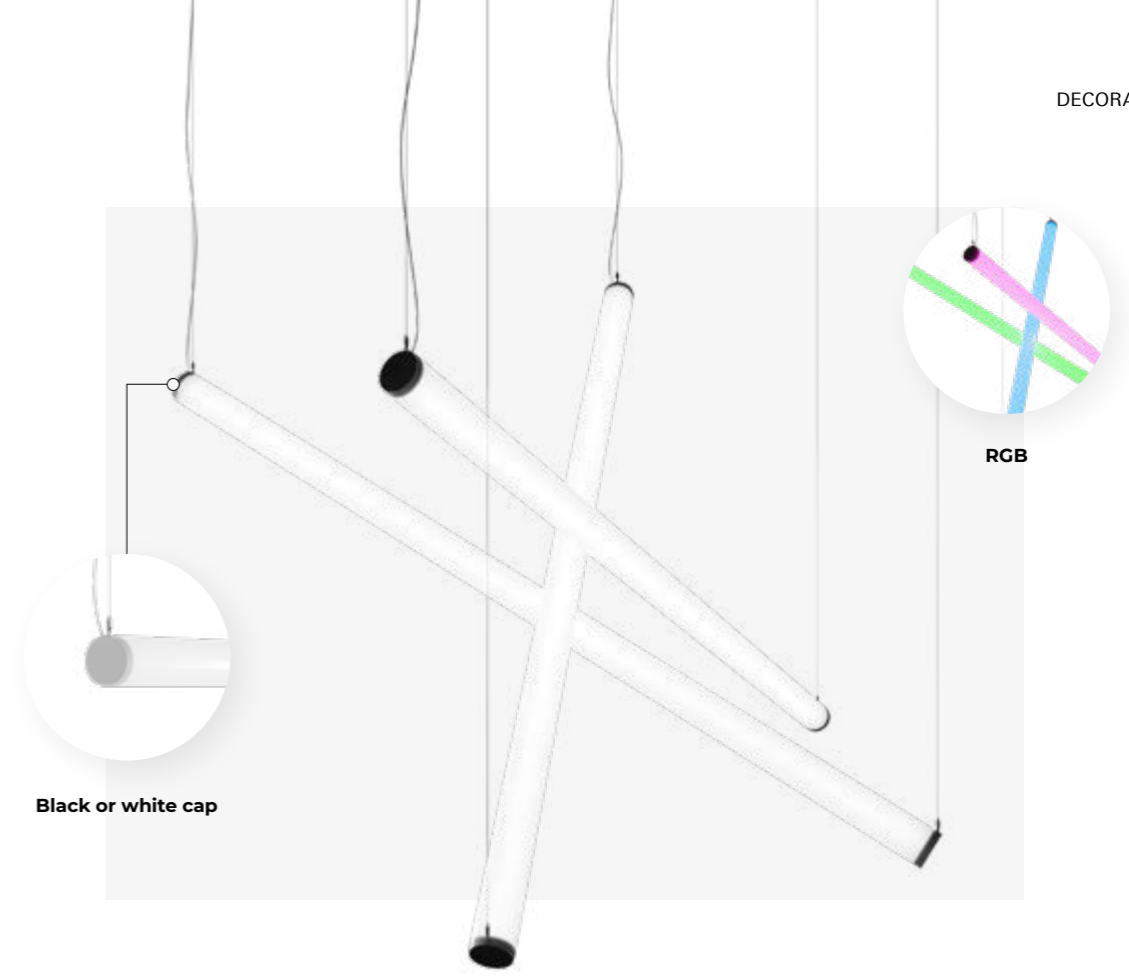

Black or white cap

RGB

MAIN FEATURES

It can be inclined on purpose

Adjust the suspension height the way you prefer Issa to be suspended. In line, completely vertically or a little inclined. The maximal inclination angle is 60°.



Vertically or horizontally

Or both. Mix and match different products the way you want.

Different lengths

Issa is available in different sizes. The combination of them creates a composition which adds an artistic touch to the ambience.



With or without a spot

It depends on the intensity of light you want to achieve whether to choose a spot or not. Do you prefer Issa to shine vividly or to glow softly?

Play with colours

Milky or tunable white is always a good choice. But sometimes, the RGB option gives an added value when creating a playful and dynamic atmosphere.



Issa

Technical Overview



	S H Suspended horizontal	S V Suspended vertical	S VS Suspended vertical with spot
Luminaire luminous flux	760 - 4900 lm 1460 lm/m	760 - 5900 lm 1460 lm/m	760 - 5900 lm 1460 lm/m
Optic	SOP	SOP	SOP
LED colour	927, 930, 935, 940	927, 930, 935, 940	927, 930, 935, 940
Dynamic illumination	RGB, Tunable white 2700-6500K	RGB, Tunable white 2700-6500K	RGB, Tunable white 2700-6500K
Driver	Casambi, DALI, FO	Casambi, DALI, FO	Casambi, DALI, FO
Driver position	Ceiling cup, remote	Ceiling cup, remote	Ceiling cup, remote
Spot information			
Luminaire luminous flux	-	-	up to 420
Beam angle	-	-	20°, 30°, 55°
LED colour	-	-	927, 930, 935, 940
Colour	1 2	1 2	1 2
Dimensions	L (mm): 565 - 2565 SH (mm): 1500, 3000, 5000	L (mm): 544 - 3044 SH (mm): 1500, 3000, 5000	L (mm): 568 - 3068 SH (mm): 1500, 3000, 5000

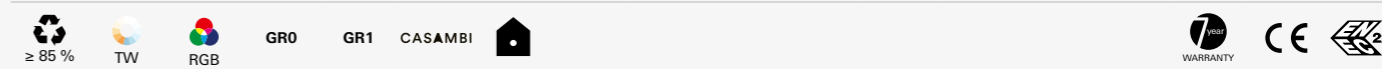
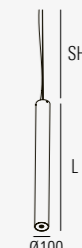
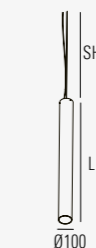
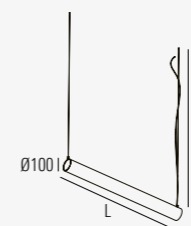

Light source: High-flux LED strip, CRI>90, MacAdam≤2, 50000h L90 B10 at 35°C.; High-power COB LED, CRI>90, MacAdam≤2, 50.000h L90 B10 at 35°C.; RGB LED strip optional. **Optic:** Satin opal polycarbonate diffuser (SOP) **Body:** Polycarbonate. **Ceiling cup:** Ceiling cup with or without driver must be ordered separately. **Control gear:** Driver must be ordered separately. **Power supply:** 24V DC/125mA.

Svetlobni vir: Visoko svetilen LED trak, CRI>90, barvno odstopanje MacAdam≤2, 50.000 h L90 B10 na 35 °C.; Visoko učinkovit COB LED modul, CRI>90, barvno odstopanje MacAdam≤2, 50.000 h L90 B10 na 35 °C.; RGB LED trak opcijnsko. **Optika:** Satiniran opalni polikarbonatni difuzor (SOP) **Ohišje:** Polikarbonat. **Stropna rozeta:** Stropno rozeto z ali brez LED konverterja je treba naročiti ločeno. **Napajalnik:** LED konverter je treba naročiti ločeno. **Napajanje:** 24 V DC/125 mA.

Izvor svetla: LED traka velikog svetlosnog toka, CRI>90, MacAdam≤2, 50.000 h L90 B10 na 35 °C.; LED COB velike snage, CRI>90, MacAdam≤2, 50.000 h L90 B10 na 35 °C.; RGB LED traka opcijnska. **Optika:** Satinirani opalni polikarbonatni difuzor (SOP) **Kućište:** Polikarbonatno. **Stropna rozeta:** Stropna rozeta sa ili bez predspojne naprave naručuje se zasebno. **Predspojne naprave:** Predspojnu napravu konstantnog izlaza potrebno je naručiti zasebno **Napajanje:** 24 V DC/125 mA.



Pipes Tube

Vertical accent

Every space should have something intriguing and thus precious

Pipes Tube is meant to enhance the space. As a strong decorative element, it draws attention. Still, its form is simple enough to blend in with the surroundings.

A variety of sizes and colours allow you to be creative in compositions and to add a personal touch to every space.

Vsak prostor bi moral imeti nekaj vznemirljivega in zato dragocenega

Pipes Tube je namenjen poudarjanju prostora. Kot močan dekorativni element sicer privlači pozornost, vendar je njegova oblika dovolj preprosta, da se lepo zlije z okoljem.

Raznolike velikosti in barve dopuščajo kreativno svobodo pri ustvarjanju kompozicij in dodajanju osebnega pečata vsakemu prostoru.

Svaki prostor treba imati detalje koji ga čine posebnim i vrijednim

Pipes Tube su namijenjene obogaćivanju prostora. Kao snažan ukrasni element, privlači pažnju dok, s druge strane, jednostavnom formom postaje bio okoline.

Raznovrsnost boja i dimenzija omogućuje kreativne kompozicije i unosenje osobnog dodira u svaki prostor.



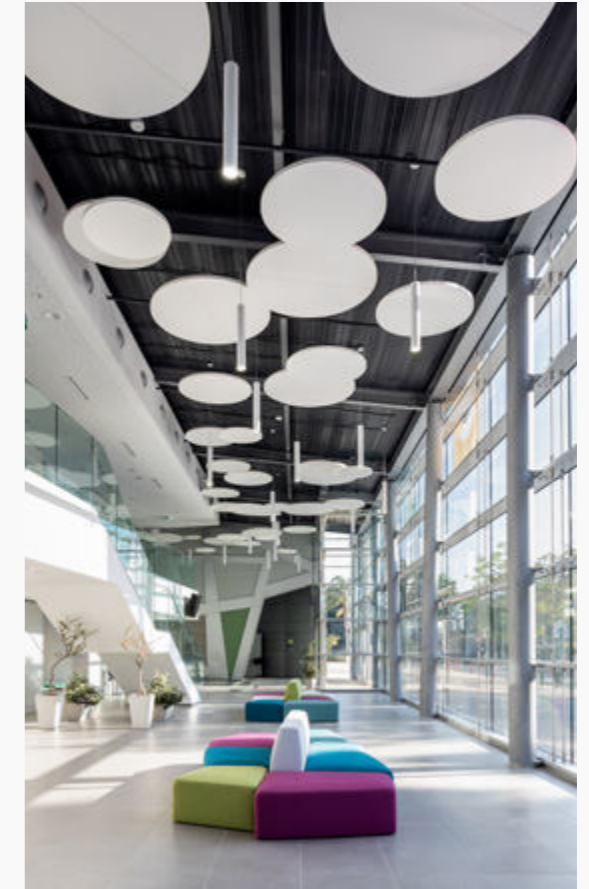

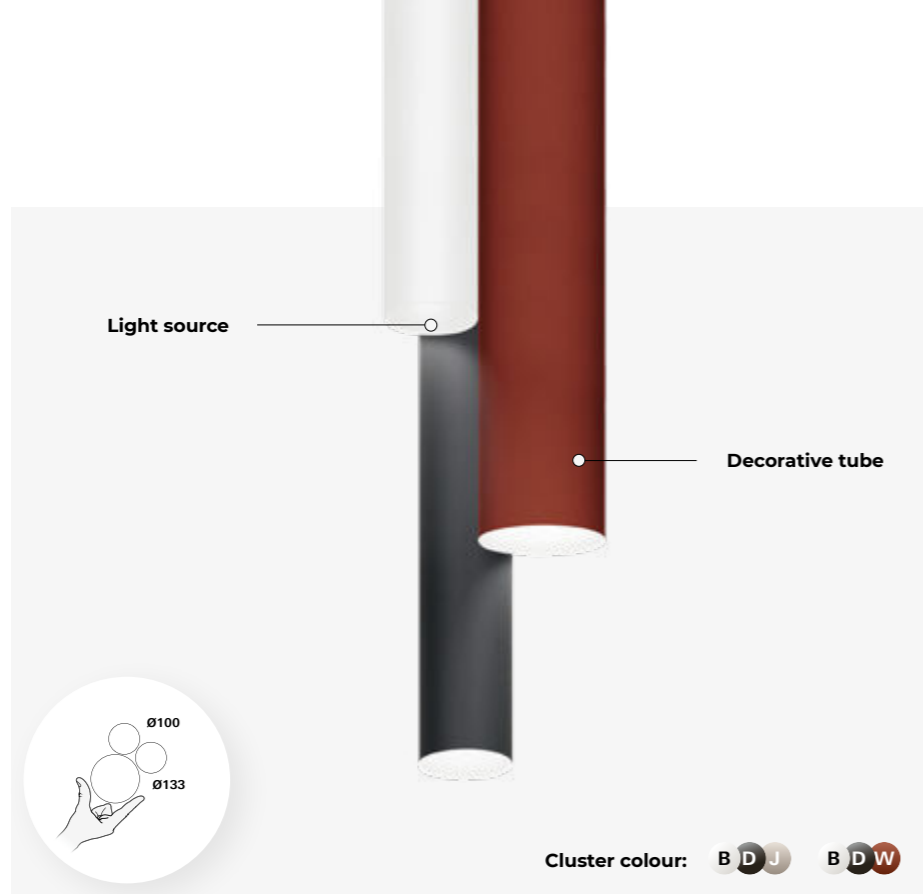

MAIN FEATURES

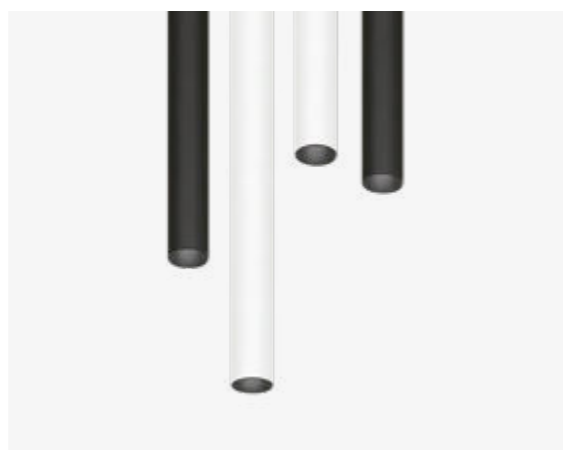

Timeless design

Clean lines and carefully chosen colours create the best timeless highlights in space. There are various lengths and diameters available.

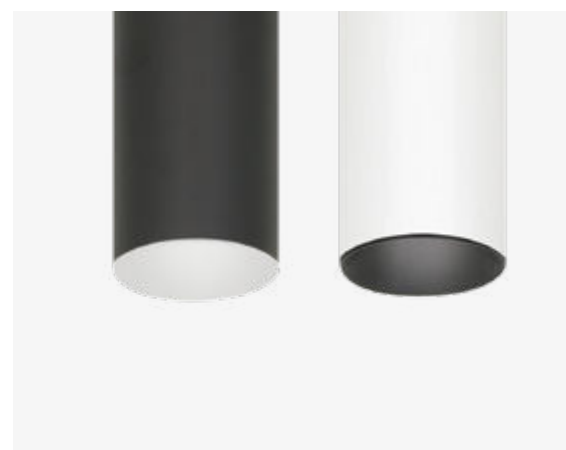

Black or white funnel?

You can choose a white or black funnel colour on the Pipes Tube S 100 version. Black funnel will reduce the glare.

Pipes Tube

Technical Overview



	SINGLE S 45 Suspended	SINGLE C/S 100 Ceiling / Suspended	CLUSTER C/S S Ceiling / Suspended Small	CLUSTER C/S L Ceiling / Suspended Large
Beam angle	20°, 30°, 55°	30°, 40°, 60°	30°, 40°, 60°	30°, 40°, 60°
Luminaire luminous flux	up to 960 lm (20°, 30°), 1150 lm (55°)	2300 - 3600 lm	2300 - 3600 lm	4600 - 7100 lm
LED colour	927, 930, 935, 940	827, 830, 840, 930, 935, 940	827, 830, 835, 840, 930, 940	827, 830, 835, 840, 930, 940
Driver	Casambi, DALI, FO	Casambi, DALI, FO	Casambi, DALI, FO	Casambi, DALI, FO
Driver position	Integrated	Integrated	Integrated	Integrated
Dimensions	H (mm): 590, 890, 1480 SH (mm): 1500, 3000, 5000	H (mm): 490 - 1980 SH (mm): 1500, 3000, 5000	SH (mm): 1500, 3000, 5000	SH (mm): 1500, 3000, 5000

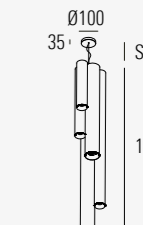
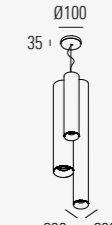
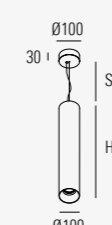
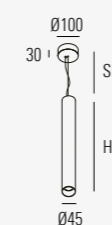

Honeycomb available for all sizes except S 45.

Standard: **B D J** Special colours:

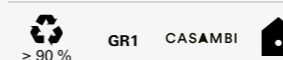

Light source: High-power COB LED, CRI>80/90, MacAdam≤2, 50.000h L90 B10 at 35°C. **Optic:** Highly efficient with uniform distribution, metalized polycarbonate with lacquer finish. **Body:** Aluminium, powder coated. **Control gear:** Integrated highly-efficient driver with fixed output (FO) or dimmable (DALI-TD, Casambi). **Power supply:** 230V 50Hz.

Svetlobni vir: Visoko učinkovit COB LED modul, CRI>80/90, barvno odstopanje MacAdams2, 50.000 h L90 B10 na 35 °C. **Optika:** Visoko učinkovit metaliziran in lakiran polikarbonat z enakomerno porazdelitvijo svetlobnega snopa. **Ohišje:** Aluminij, prašno barvan. **Napajalnik:** Integriran visoko učinkoviti LED konverter s konstantnim tokom (FO) ali regulacijskim izhodom (DALI-TD, Casambi). **Napajanje:** 230 V 50 Hz.

Izvor svjetla: LED COB velike snage, CRI 80/90, MacAdam≤2, 50.000 h L90 B10 na 35 °C. **Optika:** Visoko učinkovit s jednolikom distribucijom, metaliziran polikarbonat sa završnim slojem laka. **Kućište:** Aluminijsko, elektrostatski plastificirano. **Predspojne naprave:** Integrirana visoko efikasna predspojna naprava konstantnog izlaza (FO) ili dimabilna (DALI-TD, Casambi). **Napajanje:** 230 V 50 Hz.



Eyen

The piece

All who enter the room will look up

Eyen is a remarkable piece, meant for special offices, where you want something unique and different. Because of its outstanding design, it can't go unnoticed. Its feather-light carbon fibre body links spots which illuminate each surface optimally, without shadows. Its indirect light creates a calm atmosphere that stimulates concentration and relieves stress.

Vsi, ki vstopijo v sobo, se bodo ozrli navzgor

Eyen je posebna svetilka, namenjena pisarnam, ki jim želite dodati nekaj edinstvenega in drugačnega. Zaradi izjemnega dizajna ne more ostati neopažena. Njeno peresno lahko ohišje iz ogljikovih vlaken povezuje reflektorje, ki optimalno osvetlijo vsako površino, brez senc. Njena posredna svetloba ustvarja umirjeno vzdušje, ki spodbuja koncentracijo in odpravlja stres.

Privlači pogled svakog tko zakorači u sobu

Eyen je izvanredan komad namijenjen posebnim uredima gdje želite nešto jedinstveno i drugačije. Zbog svog izvanrednog dizajna ne može proći nezapaženo. Njegovo tijelo od karbonskih vlakana, lagano kao pero, povezuje točke koje optimalno osvjetljavaju svaku površinu bez sjena. Njegovo neizravno svjetlo stvara mirnu atmosferu koja potiče koncentraciju i ublažava stres.





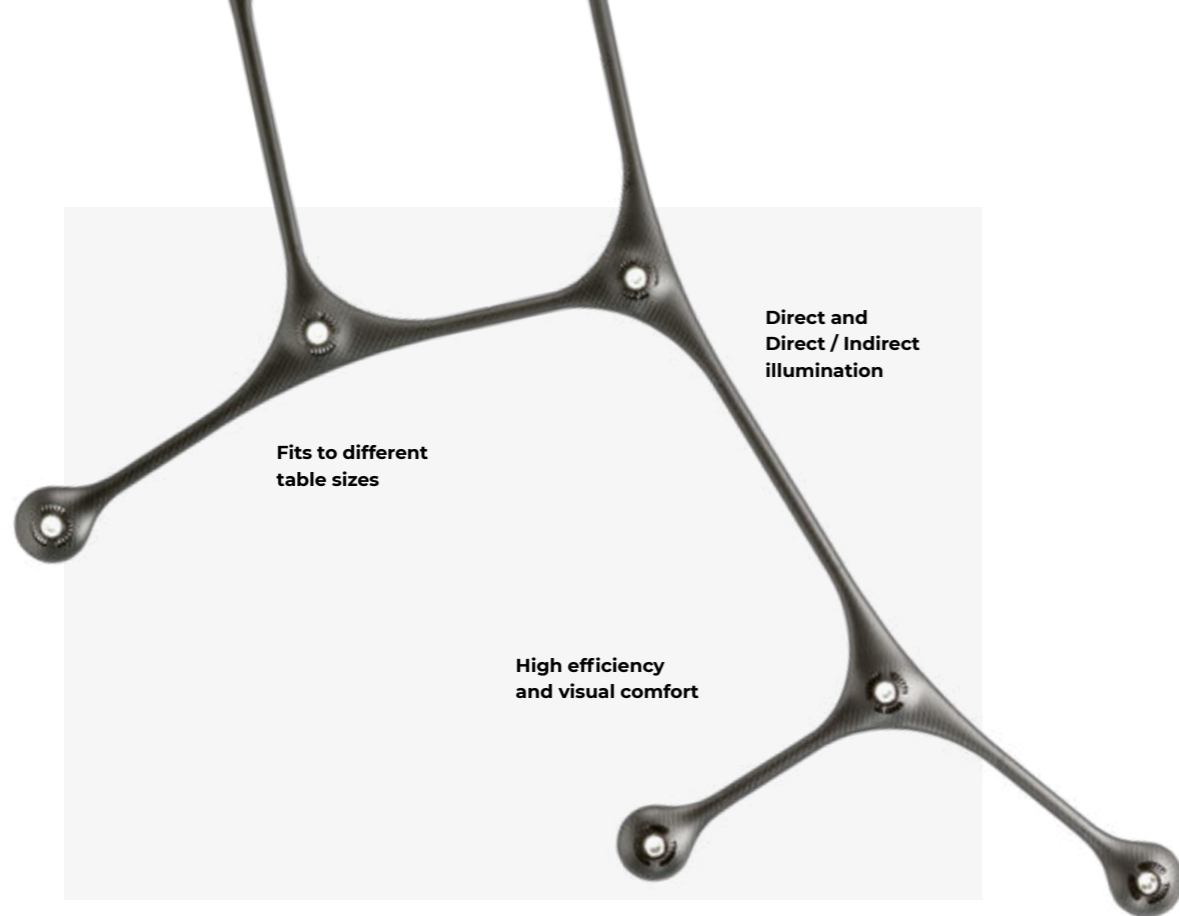

Fits to different table sizes

Direct and Direct / Indirect illumination

High efficiency and visual comfort

MAIN FEATURES

Feather-light prestige is made of carbon

No matter the size, Eyen is extremely light. The adaptable design and a different number of LED spot options ensure the evenly illumination of each surface.



High efficiency and visual comfort

A carbon fibre body links highly efficient power LED spots offering optimum illumination with excellent colour reproduction.

Eyen

Technical Overview



	S 6	S/SDI 12
	Suspended Direct	Suspended Direct, Direct / Indirect
Beam angle	55°	55°
Spot	6x	12x
Luminaire luminous flux		
Direct	2700 lm	5400 lm
Indirect	-	2950 lm
LED colour	927, 930, 935, 940	927, 930, 935, 940
Driver	Casambi, DALI	Casambi (S), DALI (S, SDI)
Material	Carbon-fibre body structure	Carbon-fibre body structure
Colour	2	2
Dimensions	SH (mm): 1500, 3000, 5000	SH (mm): 1500, 3000, 5000

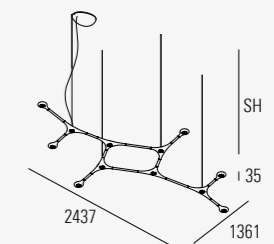
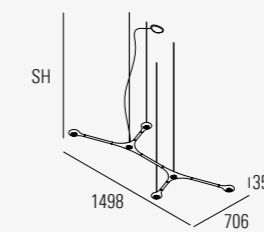

GR1 CASAMBI



Light source: High-power COB LED, CRI>90, MacAdam≤2, 50.000h L90 B10 at 35°C. **Optic:** Highly efficient with uniform distribution, metalized polycarbonate with lacquer finish. **Body:** Carbon-fibre structure. **Control gear:** Integrated highly-efficient driver dimmable (DALI, Casambi). **Power supply:** 230V 50Hz.

Svetlobni vir: Visoko učinkovit COB LED modul, CRI>90, barvno odstopanje MacAdam≤2, 50.000 h L90 B10 na 35 °C. **Optika:** Visoko učinkovit metaliziran in lakiran polikarbonat z enakomerno porazdelitvijo svetlobnega snopa. **Ohišje:** Struktura iz karbonskih vlaken. **Napajalnik:** Integriran visoko učinkoviti LED z regulacijskim izhodom (DALI, Casambi). **Napajanje:** 230 V 50 Hz.

Izvor svetla: LED COB velike snage, CRI>90, MacAdam≤2, 50.000 h L90 B10 na 35 °C. **Optika:** Visoko učinkovit s jednolikom distribucijom, metaliziran polikarbonat sa završnim slojem laka. **Kućište:** Kućište od karbonskih vlakana. **Predspojne naprave:** Integrirana visoko efikasna dimabilna predspojna naprava (DALI, Casambi). **Napajanje:** 230 V 50 Hz.



Insider

Directly indirect

It gives character to empty walls

Bring light to your wall, raise your ceiling and create the feeling of spaciousness and freedom with Insider in different dimensions and colours. Because of its delicate design, it can be easily incorporated into any interior.

Its indirect light effect makes your ceiling higher and higher. And what is more, it creates an atmosphere that will raise you up.

Praznim stenam daje značaj

Osvetlite svojo steno, optično dvignite strop in ustvarite občutek prostornosti in svobode z lučjo Insider v različnih dimenzijah in barvah. Zaradi prefinjenega dizajna se zlahka vključi v katerikoli interier. Zaradi indirektnega svetlobnega učinka strop deluje višji. Še več, ustvarja vzdušje, ki bo dvignilo vaše razpoloženje.

Daje karakter praznim zidovima

Osvjetlite svoj zid, podignite strop i stvorite osjećaj prostranosti i slobode uz Insider svjetlo u različitim dimenzijama i bojama. Zbog svog suptilnog dizajna, lako se može uklopiti u svaki interijer. Njegov neizravni svjetlosni efekt čini vaš strop višim. I štoviše, stvara atmosferu kojom podiže raspoloženje.







MAIN FEATURES



Bring light all the way up

Insider is minimalistic, but surprisingly strong. Its indirect light effect makes your ceiling higher and gives a feeling of spaciousness and freedom.

Make a difference with a colour

Choose two colours that perfectly match your interior and give character to your wall. Trendy metallic colours will bring sophistication and luxury to the space.



Insider

Technical Overview



FAMILY MEMBER

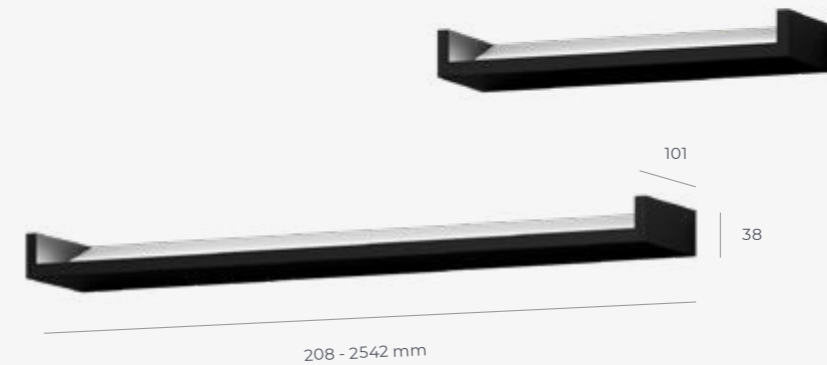

TECH. SPECS

LUMINAIRE LUMINOUS FLUX	LED COLOUR	DRIVER	OPTICS
180 - 6300 lm	827, 830, 835, 840, 930, 940	Casambi, DALI, FO	DPR

COLOUR

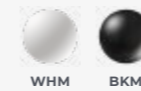

INNER COLOUR

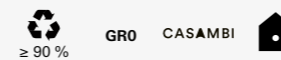
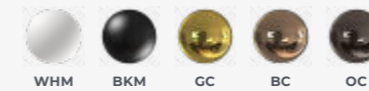

Light source: High-flux PCB LED modules, mid-power SMD LED, CRI> 80/90, MacAdam≤2, 50.000h L90 B10 at 35°C. **Optic:** Soft-light prismatic PMMA diffuser (DPR). **Body:** Extruded aluminium profile, powder coated. **Control gear:** Integrated highly-efficient driver with fixed output (FO) or dimmable (DALI-TD, Casambi). **Power supply:** 230V 50Hz.

Svetlobni vir: PCB LED moduli visoke svetilnosti, z SMD LED, CRI>80/90, barvno odstopanje MacAdam≤2, 50.000 h L90 B10 na 35 °C. **Optika:** Mikroprizmatična difuzna PMMA optika (DPR). **Ohišje:** Ekstrudirani profil iz aluminija, prašno barvan. **Napajalnik:** Integriran visoko učinkoviti LED konverter s konstantnim tokom (FO) ali regulacijskim izhodom (DALI-TD, Casambi). **Napajanje:** 230 V 50 Hz.

Izvor svetla: PCB LED moduli velikog svjetlosnog toka, SMD LED srednje snage, CRI>80/90, MacAdam≤2, 50.000 h L90 B10 na 35°C. **Optika:** Mikroprizmatična difuzna PMMA optika (DPR). **Kućište:** Ekstrudirani aluminijски profil, elektrostatski plastificiran. **Predspojne naprave:** Integrirana visoko efikasna predspojna naprava konstantnog izlaza (FO) ili dimabilna (DALI-TD, Casambi). **Napajanje:** 230 V 50 Hz.



BY CHICAGO ATHENAEUM



BIGSEE
PRODUCT DESIGN
AWARD
2019



Vitka

Thin line

Vitka doesn't need to hang out next to thick luminaires just to look thin

They say it's a thin line between elegance and confidence, but we say that there doesn't need to be any line at all, you can have this all together. Thanks to its application flexibility and lighting control, Vitka is one of our top notch ambient luminaires.

Discover the variety of Vitka's applications when you're creating an office, reception area, hospitality facilities or at home, and prepare for a big surprise from such a small luminaire.

Vitki se ni treba znajti med debelejšimi svetili, da bi bila videti vitka

Pravijo, da je med eleganco in samozavestjo tanka meja. Mi pa pravimo, da meja sploh ni potrebna, saj imamo lahko oboje. Zaradi fleksibilnosti pri uporabi in možnosti nadziranja svetlobe Vitka velja za eno izmed naših vrhunskih ambientalnih svetilk.

Raziščite raznolikost njene uporabe in si dajte duška pri opremljanju pisarne, hotelske recepcije, sobe ali doma ter se pripravite na veliko presenečenje izredno drobnega svetila.

Vitka ne treba visjeti pokraj debelih rasvjetnih tijela da bi se istaknula s tankočom

Kažu da je tanka linija između elegancije i smjelosti, ali mi kažemo da uopće ne mora postojati nikakva linija, kako biste sve ovo imali zajedno. Zahvaljujući svojoj fleksibilnoj primjeni i kontroli rasvjete, Vitka je jedno od naših vrhunskih rasvjetnih tijela.

Otkrijte raznolikost aplikacija Vitke prilikom stvaranja ureda, recepcija, ugostiteljskih objekata ili kod kuće i pripremite se na veliko iznenađenje od tako malog rasvjetnog tijela.







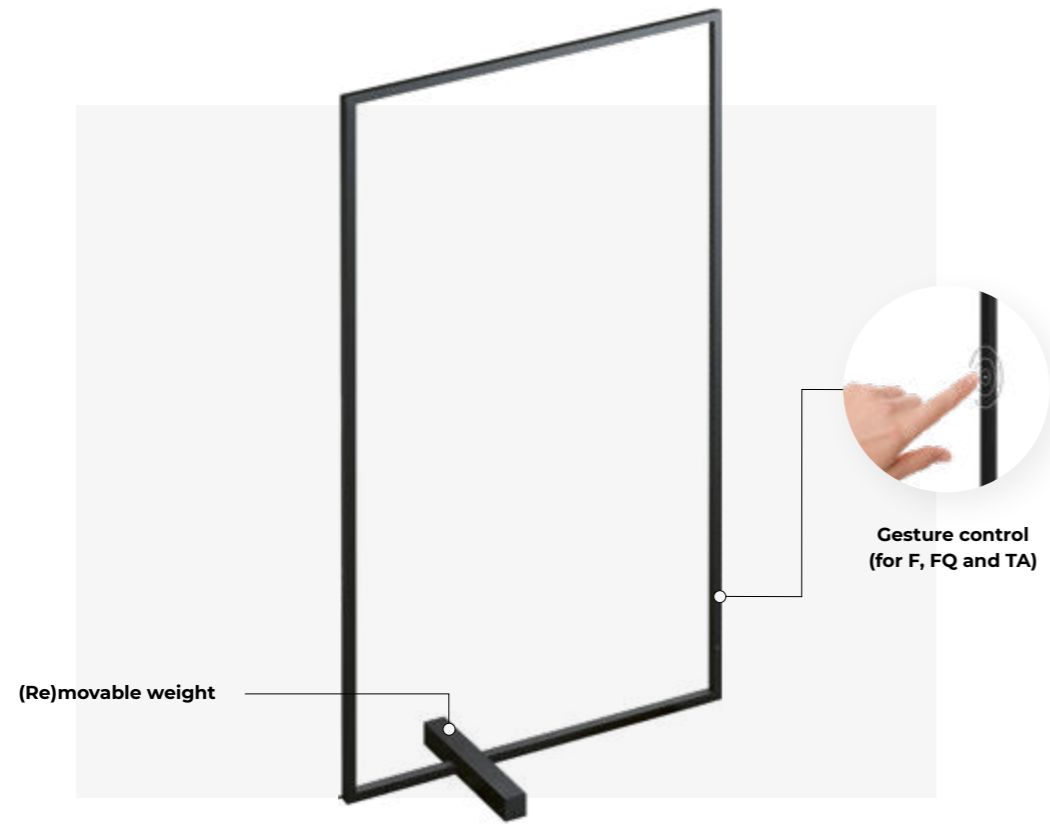

MAIN FEATURES



Dimmable without a switch

Just hold your finger at the sensor if you want to dim the light.



Soft ambient light

This slim luminaire brings elegance and softness with both its looks and light. The optic offers a pleasant illumination with low glare, perfect for all situations when you don't need a classic office lighting.

(Re)movable weight

The stability weight can also be moved along the profile or removed. When leaning against the wall it creates a more dramatic lighting atmosphere while free-standing positioning provides a more even distribution of light across the room.



An added value to any space

When on, its soft light creates a unique calming atmosphere. When off, it also functions as an art piece which gives character to your space.



Vitka

Technical Overview

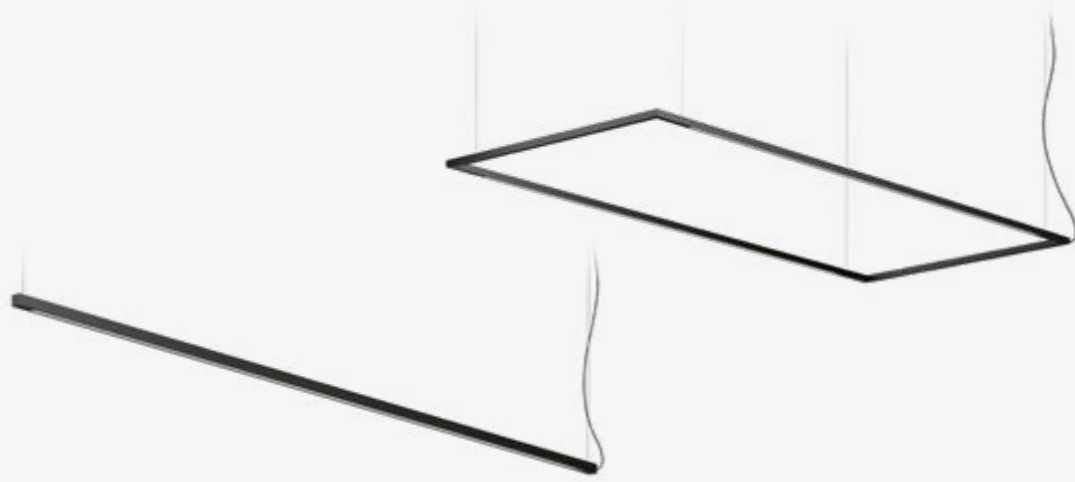

	S Suspended linear	SQ Suspended rectangular	F Floor linear	FO Floor rectangular	TA Table
Luminaire luminous flux	680 - 1200 lm	1700 - 3400 lm	280 - 1150 lm	440 - 1100 lm	630 - 660 lm
LED colour	827, 830, 840, 930, 940	827, 830, 840, 930, 940	827, 830, 840, 930, 940	827, 830, 840, 930, 940	930, 940
Driver	Casambi, DALI, FO	Casambi, DALI, FO	TD (gesture control)	TD (gesture control)	TD (gesture control)
Driver position	Ceiling cup, Remote	Ceiling cup, Remote	Universal plug	Universal plug	Universal plug
Optics	SOP	SOP	SOP	SOP	SOP
Colour	2	2	2	2	2

Dimensions	S	SQ	F	FO	TA
	L (mm): 1240, 1540, 1740 SH (mm): 1500, 3000, 5000	LxW (mm): 1680/2080x500, 2080/2690x700, 1740/2690x800 SH (mm): 1500, 3000, 5000	H (mm): 650, 1800	H (mm): 900, 1600	

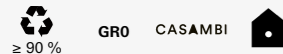
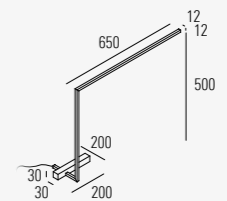
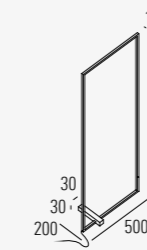
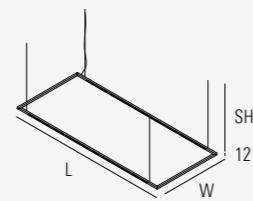
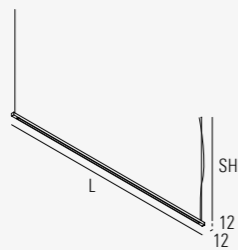

Light source: High-flux PCB LED modules, mid-power SMD LED, CRI>80/90, MacAdam \leq 2, 50.000h L90 B10 at 35°C. **Optic:** Satin opal polycarbonate diffuser (SOP) **Body:** Extruded aluminium profile, powder coated. **Control gear:** Supplied with highly-efficient driver with fixed output (FO) or dimmable (DALI-TD, Casambi). Table/floor version are supplied with universal plug-in driver. Suspended versions with LD/RD250 ceiling cup are supplied with highly-efficient driver with fixed output (FO) or dimmable (DALI-TD, Casambi). For versions with RF ceiling cup constant voltage driver must be ordered separately. **Power supply:** 230V 50Hz / 24V DC.

Svetlobni vir: PCB LED moduli visoke svetilnosti, z SMD LED, CRI>80/90, barvno odstopanje MacAdam \leq 2, 50.000 h L90 B10 na 35 °C. **Optika:** Satiniran opalni polikarbonatni difuzor (SOP) **Ohišje:** Ekstrudiran profil iz aluminija, prašno barvan. **Napajalnik:** Priložen visoko učinkoviti LED konverter s konstantnim tokom (FO) ali regulacijskim izhodom (DALI-TD, Casambi). Talna/namizna verzija je opremljena z LED konverterjem v vtikaču. Viseče verzije LD/RD250 imajo LED konverter s konstantnim tokom (FO) ali regulacijskim izhodom (DALI-TD, Casambi) vgrajen v rozeti, za verzijo RF pa je potrebno naročiti ločeno. **Napajanje:** 230 V 50 Hz / 24 V DC.

Izvor svetla: PCB LED moduli velikog svetlosnog toka, SMD LED srednje snage, CRI>80/90, MacAdam \leq 2, 50.000 h L90 B10 na 35 °C. **Optika:** Satinirani opalni polikarbonatni difuzor (SOP) **Kućište:** Ekstrudirani aluminijски profil, elektrostatski plastificiran. **Predspojne naprave:** U kompletu s visoko učinkovitim LED konverterom s konstantnim tokom (FO) ili regulacijskim izlazom (DALI-TD, Casambi). Stolna ili stajaća inačica je opremljena univerzalnim plug - in driverom. Ovjese inačice s LD/RD250 rozetom opremljene su s visokoeфикаsnom predspojnom napravom konstantnog izlaza (FO) ili dimabilnom (DALI-TD, Casambi). Za inačice s RD rozetom, FO predspojna naprava naručuje se zasebno **Napajanje:** 230 V 50 Hz / 24 V DC.



Gramm

The lightest light

Feather lightness in the space

Gramm is elegant and focused, meant to enlighten only what is needed. It is round-shaped, and its main feature is the possibility of rotation which allows a lot of flexibility. When you want a pleasant indirect light, you simply rotate it up with one move.

A name, a guarantee. Gramm will always bring a feeling of feather lightness to the space. Because Gramm is light, period.

Peresna lahkotnost v prostoru

Gramm je elegantna svetilka, ki usmerjeno osvetljuje le, kar je potrebno. Je okrogle oblike, njena glavna prednost pa je možnost vrtenja, ki omogoča veliko prilagodljivosti. Ko želite prijetno indirektno svetlobo, jo preprosto zavrtite z enim gibom navzgor.

Gramm. Ime, ki pove vse. V prostor bo ta svetilka vedno prinesla občutek peresne lahkotnosti. Ker je preprosto lahka.

Prostor ispunjen svjetlošću laganom poput pera

Gramm je elegantno i fokusirano svjetlo, namijenjeno korištenju samo onda kada je to potrebno. Okruglo je, a njegova glavna karakteristika je mogućnost rotacije kojom postiže veliku fleksibilnost. Kada želite ugodno neizravno svjetlo, jednim potezom jednostavno ga možete zarotirati prema gore.

Njegovo ime je garancija. Gramm će uvijek unijeti osjećaj lakoće u prostor, poput pera. Gramm je nježan i točka.







Available in brushed and coated colours

MAIN FEATURES

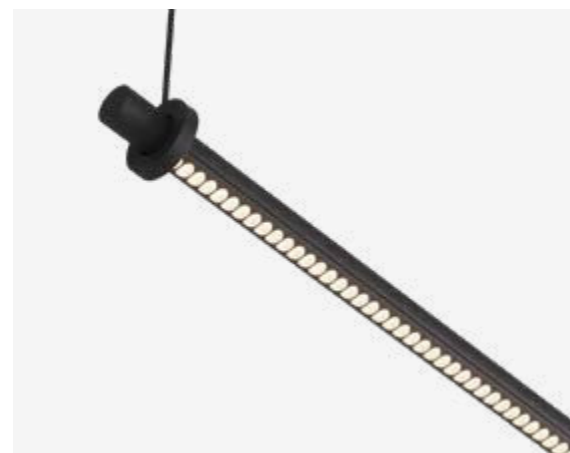

Soft ambient light

This slim luminaire brings elegance and softness with both its looks and light. The optic offers a pleasant illumination with low glare, perfect for all situations when you don't need a classic office lighting.



Just rotate it for indirect light

You rotate it up with one move when you want a pleasant indirect light. This is its great advantage.

Gramm

Technical Overview



S LGO

Suspended low glare linear grid optic

S SOP

Suspended satin opal diffuser

S DUO

Suspended double

Luminaire luminous flux	210 lm/m	681 lm/m	122 - 1228 lm
Optic	LGO	SOP	SOP, LGO
LED colour	927, 930, 940	927, 930, 940	927, 930, 935, 940
Driver	Casambi, DALI, FO	Casambi, DALI, FO	Casambi, DALI, FO
Driver position	Ceiling cup, remote	Ceiling cup, remote	Ceiling cup, remote
Colour	2 H F Y M R W	2 H F Y M R W	2 H F Y M R W
Dimensions	L (mm): 560 - 1660 SH (mm): 500 - 2000	L (mm): 560 - 1660 SH (mm): 500 - 2000	L (mm): 560 - 1660 SH (mm): 1000 - 2000

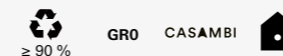
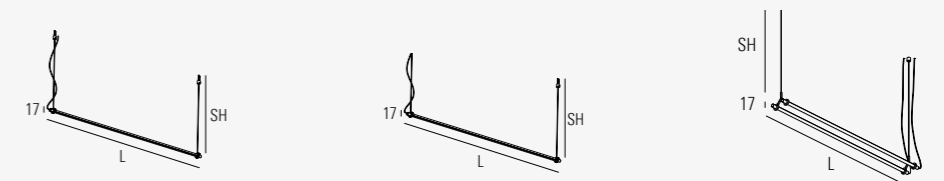

Light source: High-flux LED strip, CRI>90, MacAdam \leq 2, 50000h L90 B10 at 35°C. **Optic:** Satin opal polycarbonate diffuser (SOP). Low glare linear grid optic (LGO). **Body:** Extruded aluminium profile, powder coated. **Ceiling cup:** Ceiling cup with or without driver must be ordered separately. **Control gear:** Constant voltage driver - order separately. **Power supply:** 24V DC.

Svetlobni vir: Visoko svetilen LED trak, CRI>90, barvno odstopanje MacAdam \leq 2, 50.000 h L90 B10 na 35 °C. **Optika:** Satiniran opalni polikarbonatni difuzor (SOP). Linearna optična rešetka z omejenim bleščanjem (LGO). **Ohišje:** Ekstrudiran profil iz aluminija, prašno barvan. **Stropna rozeta:** Stropno rozeta z ali brez LED konverterja je potrebno naročiti ločeno. **Napajalnik:** LED konverter s konstantno napetostjo - ločeno naročanje. **Napajanje:** 24 V DC.

Izvor svetla: LED traka velikog svetlosnog toka, CRI>90, MacAdam \leq 2, 50.000 h L90 B10 na 35 °C. **Optika:** Satinirani opalni polikarbonatni difuzor (SOP). Linearna rešetkasta optika ograničenog bliještanja (LGO). **Kućište:** Ekstrudirani aluminijски profil, elektrostatski plastificiran. **Stropna rozeta:** Stropna rozeta sa ili bez predspojne naprave naručuje se zasebno. **Predspojne naprave:** Predspojna naprava konstatnog napona- naručiti zasebno. **Napajanje:** 24 V DC.



Glazer

Table friendly

Glazer is linear, optimised for the table

Glazer responds to your needs for excellent illumination. The soft edge design allows you to reach a high visual comfort and low glare by making a smooth light transition on the frame.

It is an extremely functional luminaire, more than perfect for those who want something simple and smart. Its design has nothing more to add and nothing left to take away. This is where its beauty comes from.

Svetilo Glazer je linearno, posebej primerno za nad mizo

Glazer se odziva na potrebe po odlični osvetlitvi. Njegovi mehki robovi omogočajo visoko svetlobno udobje in omejitev bleščanja, saj svetloba mehko prehaja na okvir.

To izredno uporabno svetilo je popolna izbira za vse, ki želijo nekaj enostavnega, a pametnega. Njegovi obliki ni kaj dodati niti odvzeti. V tem je bistvo njegove lepote.

Glazer je linearan, optimiziran za stol

Glazer se odziva potrebama za izvršnom rasvjetom. Dizajn mekanog ruba omogućuje visoku vizualnu udobnost i mali odsjaj čineći blagi prijelaz svjetla na okviru.

To je ekstremno funkcionalno rasvjetno tijelo, više nego savršeno za one koji žele nešto jednostavno i pametno. Njegovu se dizajnu ništa više ne može dodati i nema ničega preostalog za ukloniti. Otuda dolazi njegova ljepota.



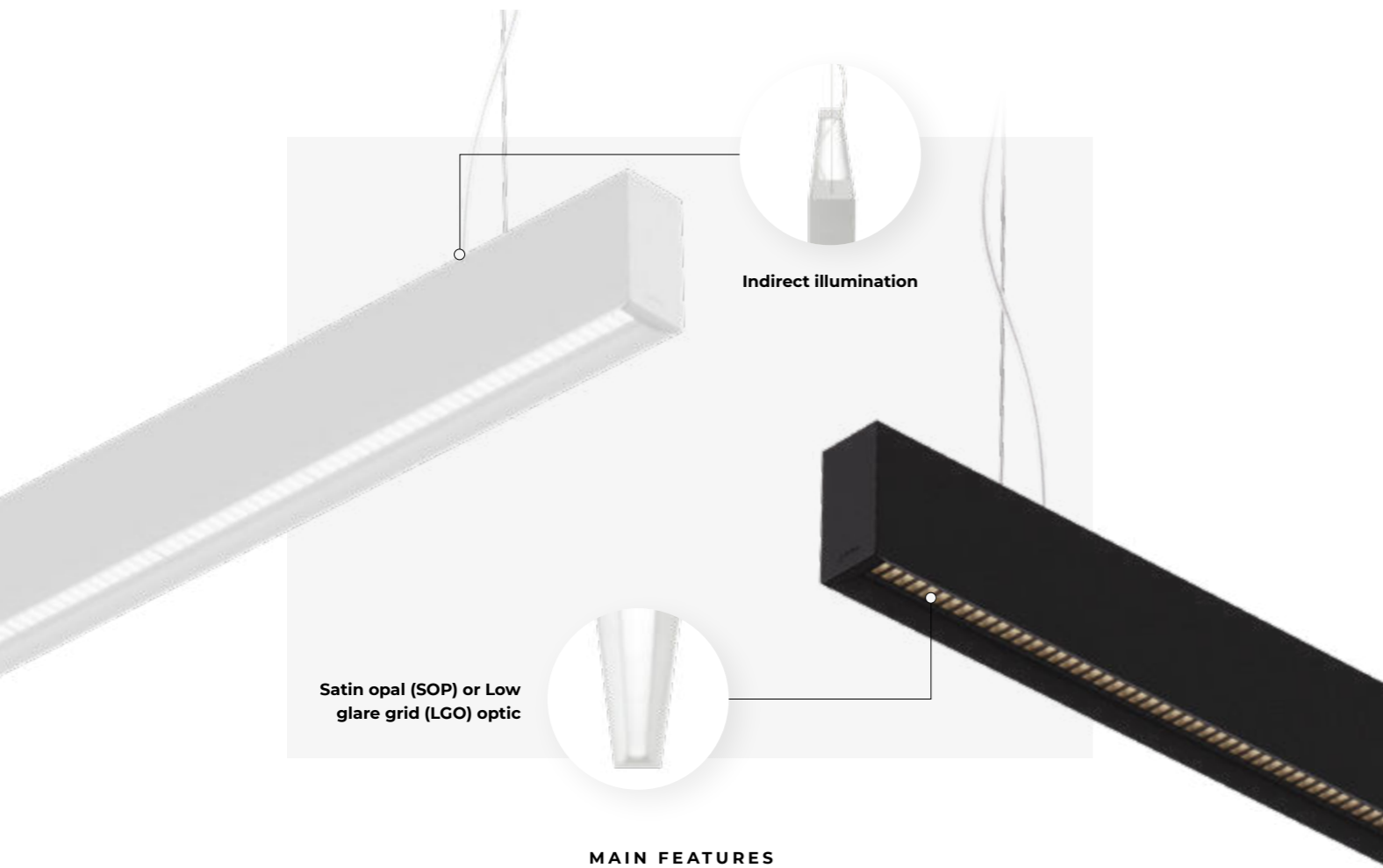

MAIN FEATURES

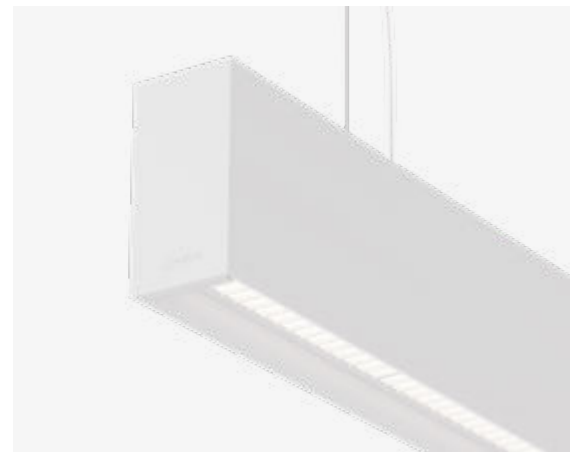

Curved frame for soft light transition

Carefully designed frame allows soft light transition and softens the contrast between lit and non-lit surfaces.



Regressed diffuser

The diffuser and the light source are regressed in the profile to reduce eye contact with the illuminated surface and improve visual comfort.

Glazer

Technical Overview

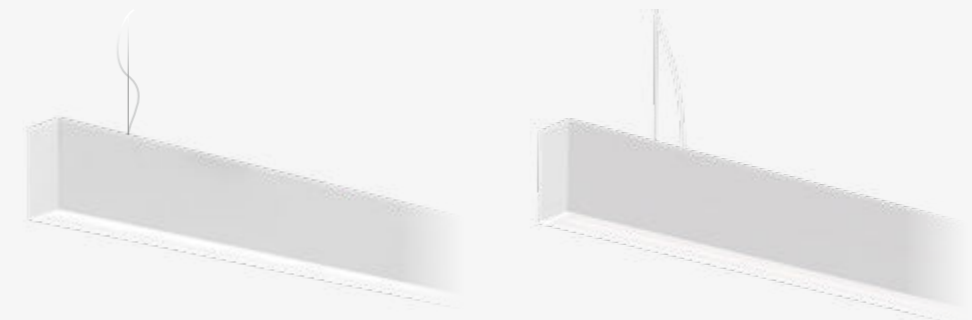

SDI LGO
Suspended Direct / Indirect low glare linear grid optic



SDI SOP
Suspended Direct / Indirect satin opal diffuser



Glare control (UGR class)	UGR<19	-
Luminaire luminous flux	2200 - 3100 lm/m	2300 - 3200 lm/m
Light distribution	Direct / Indirect	Direct / Indirect
Optics	LGO	SOP
LED colour	930, 940	930, 940
Driver	Casambi, DALI, FO, TD	Casambi, DALI, FO, TD
Colour	1 2	1 2
Dimensions	L (mm): 1434 - 3114 SH (mm): 1500, 3000, 5000	L (mm): 1434 - 3114 SH (mm): 1500, 3000, 5000

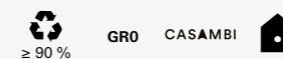
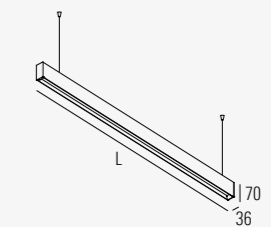
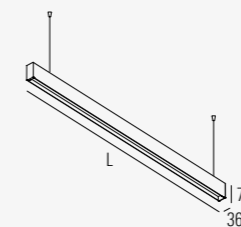

Light source: High-flux PCB LED modules, mid-power SMD LED, CRI>90, MacAdam≤2, 50.000h L90 B10 at 35°C. **Optic:** Satin opal polycarbonate diffuser (SOP). Low glare linear grid optic (LGO) **Body:** Extruded aluminium profile, powder coated. **Ceiling cup:** For suspended versions, the ceiling cup and suspension set must be ordered separately. Find out more on the technical pages or online product configurator. **Control gear:** Integrated highly-efficient driver with fixed output (FO) or dimmable (DALI-TD, Casambi). Optional separate switching for Direct / Indirect versions. **Power supply:** 230V 50Hz.

Svetlobni vir: High-flux PCB LED modules, z SMD LED, CRI>90, MacAdam≤2, 50.000 h L90 B10 na 35 °C. **Optika:** Satinirani opalni polikarbonatni difuzor (SOP). Linearna optična rešetka z omejenim bleščanjem (LGO) **Ohišje:** Ekstrudiran profil iz aluminija, prašno barvan. **Stropna rozeta:** Za viseče verzije se rozete in vešala naročajo posebej. Več na straneh s tehnično vsebino ali v spletnem konfiguratorju. **Napajalnik:** Integriran visoko učinkoviti LED konverter s konstantnim tokom (FO) ali regulacijskim izhodom (DALI-TD, Casambi). Opcijsko ločeno prižiganje direktne / indirektno komponente. **Napajanje:** 230 V 50 Hz.

Izvor svetla: PCB LED moduli velikog svetlosnog toka, SMD LED srednje snage, CRI>90, MacAdams≤2, 50.000 h L90 B10 na 35 °C. **Optika:** Satinirani opalni polikarbonatni difuzor (SOP). Linearna rešetkasta optika ograničenog bliještanja (LGO) **Kućište:** Ekstrudirani aluminijски profil, elektrostatski plastificiran. **Stropna rozeta:** Za ovesne inačice, stropna rozeta i ovesni pribor moraju biti naručeni zasebno. Otkrij više na tehničkim stranicama ili online konfiguratoru proizvoda. **Predspojne naprave:** Integrirana visoko efikasna predspojna naprava konstantnog izlaza (FO) ili dimabilna (DALI-TD, Casambi). Odvojeno paljenje direktne/indirektno komponente na zahtjev. **Napajanje:** 230 V 50 Hz.



Minus

Make rhythm, break rhythm

The only Minus which is a plus

This family range can play many roles. Arranged in various compositions it can become the source of creativity, whereas, when placed in an organized setting, it brings order and structure.

With the »light around« effect, Minus brings a new dimension in low ceiling spaces. By illuminating the ceiling itself, the ceilings become visually elevated.

Edini Minus, ki je plus

Ta družina svetil lahko igra veliko vlog. Umeščena v različne kompozicije, lahko postane vir ustvarjalnosti, medtem ko v urejenem zaporedju v prostor vnaša red in strukturo.

Z učinkom osvetlitve okoli svoje osi vnaša Minus v prostore z nizkimi stropi povsem nove dimenzije. Osvetljeni stropi so vizualno višji.

Jedini Minus koji je plus

Obitelj ove linije može igrati mnoge uloge. Posložena u različite kompozicije, može postati izvor kreativnosti, dok postavljena u organizirane sklopove donosi red i strukturu.

S učinkom »zaokruženog svjetla«, Minus donosi novu dimenziju u prostore s niskim stropovima. Osvjetljavajući sam strop, stropovi postaju naizgled podignuti.





147 Rabobank Dommelstreek in Geldrop, Noord-Brabant, The Netherlands / Architecture: Van den Pauwert Architecten BNA / Lighting design: DPL Europe / Photography: David Rozemeyer Fotografie



LJVE, Bologna, Italy / Architecture: Studio Minaldi
House M, Slovenia / Architecture: SoNo Architects / Photography: Žiga Lovšin



MAIN FEATURES



A graphic element

White or RGB options are a perfect canvas for creative ideas. Minus Square integrates easily into any interior, lighting up uniformly the whole space.

Light all around

Indirect, uniform illumination is perfect for low ceiling spaces. By illuminating the ceiling itself, it becomes visually elevated and appears much higher.



Minus

Technical Overview

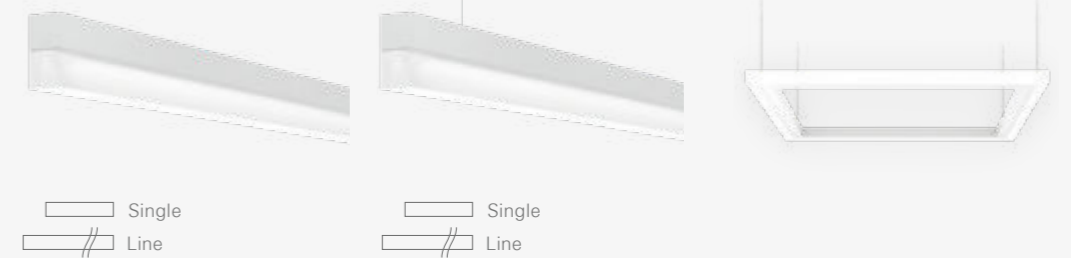

	C Ceiling	S Suspended	S Square Suspended
Luminaire luminous flux/m	1050 - 2750 lm/m	1050 - 2750 lm/m	2350 - 9500 lm
Optics	SOP	SOP	SOP
LED colour	827, 830, 835, 840, 930, 940	827, 830, 835, 840, 930, 940	827, 830, 835, 840, 930, 940
Driver	Casambi, DALI, FO	Casambi, DALI, FO	Casambi, DALI, FO
Colour	1 2	1 2	1 2
Dimensions	L (mm): 565 - 3082	L (mm): 565 - 3082 SH (mm): 1500, 3000, 5000	L (mm): 650x650, 930x930 SH (mm): 1500, 3000, 5000

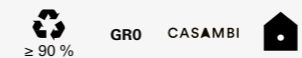
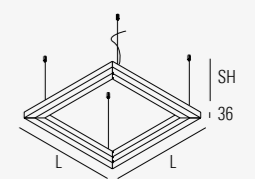
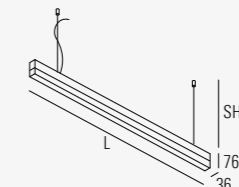
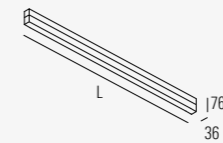

Light source: High-flux PCB LED modules, mid-power SMD LED, CRI>80/90, MacAdam≤2, 50.000h L90 B10 at 35°C. **Optic:** Satin opal polycarbonate diffuser (SOP) **Body:** Extruded aluminium profile, powder coated. **Ceiling cup:** For suspended versions, the ceiling cup and suspension set must be ordered separately. Find out more on the technical pages or online product configurator. **Control gear:** Integrated highly-efficient driver with fixed output (FO) or dimmable (DALI-TD, Casambi). **Power supply:** 230V 50Hz.

Svetlobni vir: PCB LED moduli visoke svetilnosti, z SMD LED, CRI>80/90, barvno odstopanje MacAdam≤2, 50.000 h L90 B10 na 35 °C. **Optika:** Satinirani opalni polikarbonatni difuzor (SOP) **Ohišje:** Ekstrudiran profil iz aluminija, prašno barvan. **Stropna rozeta:** Za viseče verzije se rozete in vešala naročajo posebej. Več na straneh s tehnično vsebino ali v spletnem konfiguratorju. **Napajalnik:** Integriran visoko učinkoviti LED konverter s konstantnim tokom (FO) ali regulacijskim izhodom (DALI-TD, Casambi). **Napajanje:** 230 V 50 Hz.

Izvor svetla: PCB LED moduli velikog svetlosnog toka, SMD LED srednje snage, CRI>80/90, MacAdam≤2, 50.000 h L90 B10 na 35 °C. **Optika:** Satinirani opalni polikarbonatni difuzor (SOP) **Kućište:** Ekstrudirani aluminijски profil, elektrostatski plastificiran. **Stropna rozeta:** Za ovesne inačice, stropna rozeta i ovesni pribor moraju biti naručeni zasebno. Otkrij više na tehničkim stranicama ili online konfiguratoru proizvoda. **Predspojne naprave:** Integrirana visoko efikasna predspojna naprava konstantnog izlaza (FO) ili dimabilna (DALI-TD, Casambi). **Napajanje:** 230 V 50 Hz.



Night & Day

Changes by turning

Sometimes a twist in direction is all you need

Night & Day is designed for spaces where one line isn't what you need. By joining two functionalities (direct & indirect) in a new way, you will get a flexible product that changes by turning.

It brings a distinctive look and once installed is never the same. It can be used as a single luminaire or in composition, allowing new possibilities of applications.

Včasih zadošča že sprememba smeri

Svetilo Night & Day je zasnovano za prostore, kjer je zgolj ena linija premalo. Z drugačno združitvijo dveh funkcionalnosti (direktne in indirektne svetlobe) je nastalo fleksibilno svetilo, ki se spreminja z zasukom.

Odlikuje ga poseben izgled in lastnost, da ni nikoli enako. Svetilo lahko namestimo samostojno ali v kompoziciji, kar prinaša nove možnosti uporabe.

Ponekad je promjena smjera sve što je potrebno

Night & Day je oblikovan za prostore gdje jedna linija nije ono što vam je potrebno. Spajanjem dviju funkcionalnosti (direktne i indirektne), dobit ćete fleksibilan sustav koji se mijenja okretanjem.

Donosi karakterističan izgled, a kad je jednom instaliran, više nikad nije isti. Može se koristiti kao jedno rasvjetno tijelo ili kao kompozicija, omogućavajući razne kombinacije primjene.





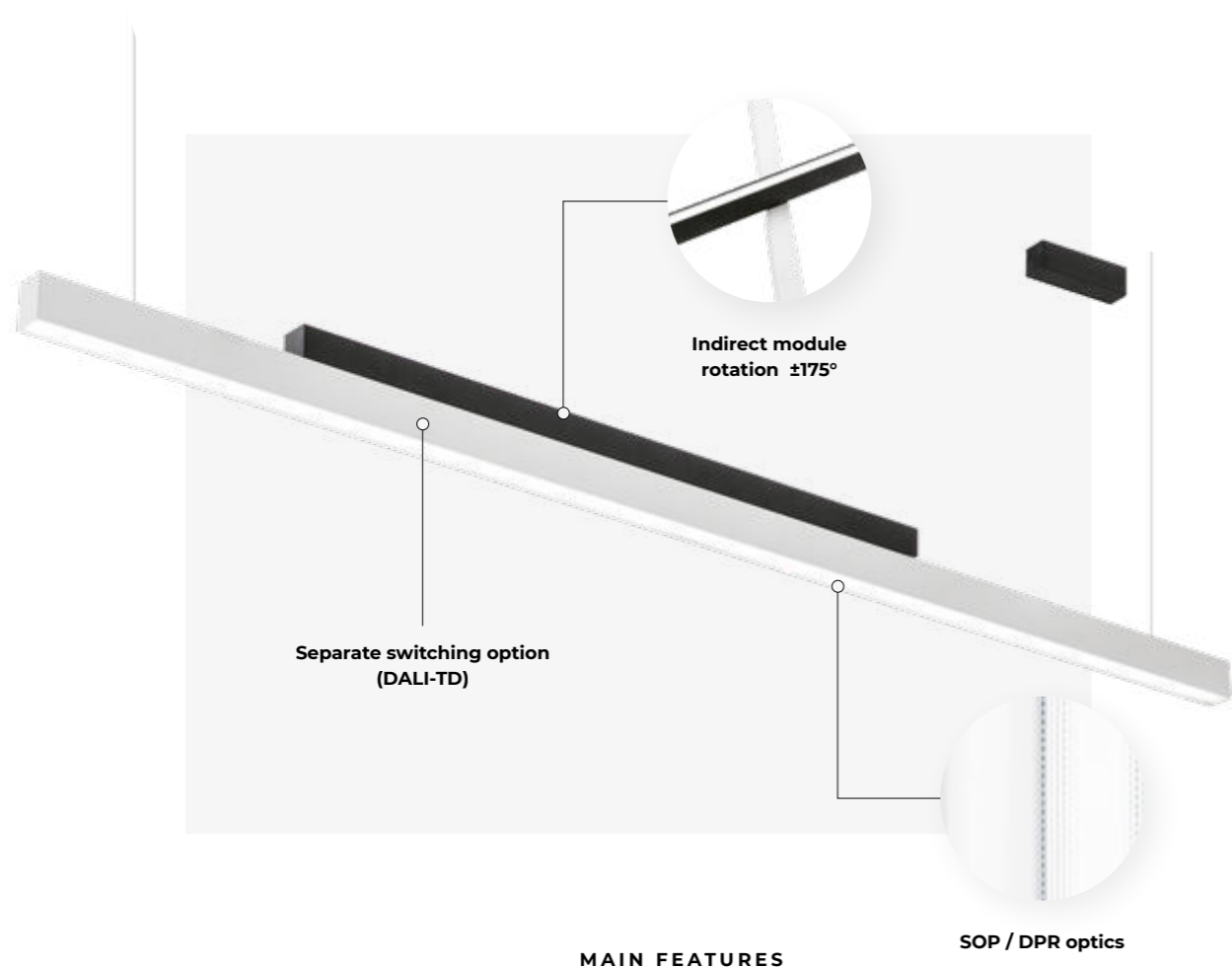

MAIN FEATURES

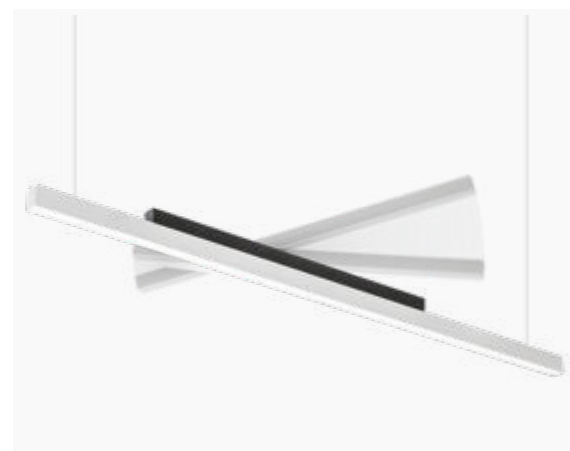

Changes by turning

Joining two functionalities (direct and indirect) in a composition that changes by turning.



A distinctive look

Designed for spaces where one line isn't what you need. When installed, it's never the same, giving your room uniqueness.

Night & Day

Technical Overview

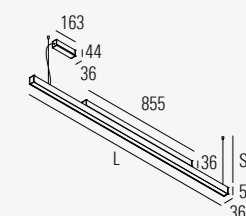

FAMILY MEMBER

TECH. SPECS

COLOURS

LUMINAIRE LUMINOUS FLUX	LED COLOUR	LENGTH (L)	
2400 - 9100 lm	827, 830, 835, 840, 930, 940, Tunable White 2700-6500 K	1685 - 2525 mm	
LIGHT DISTRIBUTION	OPTICS	DRIVER	SUSPENSION HEIGHT (SH)
Direct / Indirect	DPR, SOP	Casambi, DALI, FO, TD	1500, 3000, 5000 mm

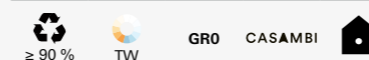
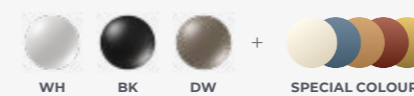

Light source: High-flux PCB LED modules, mid-power SMD LED, CRI>80/90, MacAdam≤2, 50.000h L90 B10 at 35°C. **Optic:** Satin opal diffuser (SOP) or soft-light prismatic optics (DPR) from polycarbonate for direct light. Satin opal polycarbonate diffuser (SOP) for indirect light. **Body:** Extruded aluminium profile, powder coated. **Control gear:** Integrated highly-efficient driver with fixed output (FO-DS) or dimmable (DALI-DS, TD, Casambi) - separate switching. **Power supply:** 230V 50Hz.

Svetlobni vir: PCB LED moduli visoke svetilnosti, z SMD LED, CRI>80/90, barvno odstopanje MacAdam≤2, 50.000 h L90 B10 na 35 °C. **Optika:** Satinirani opalni polikarbonatni difuzor (SOP) ali mikro-prizmatična difuzna PMMA optika (DPR) za direktno osvetlitev in opalni polikarbonatni difuzor (SOP) za indirektno osvetlitev. **Ohišje:** Ekstrudiran profil iz aluminija, prašno barvan. **Napajalnik:** Integriran visoko učinkoviti LED konverter s konstantnim tokom (FO-DS) ali regulacijskim izhodom (DALI-DS, TD, Casambi) - ločeno prižiganje. **Napajanje:** 230 V 50 Hz.

Izvor svetla: PCB LED moduli velikog svetlosnog toka, SMD LED srednje snage, CRI>80/90, MacAdam≤2, 50.000 h L90 B10 na 35 °C. **Optika:** Satinirani opalni difuzor (SOP) ili polikarbonatna prizmatična optika (DPR) za direktnu komponentu. Satinirani opalni polikarbonatni difuzor (SOP) za indirektnu komponentu. **Kućište:** Ekstrudirani aluminijски profil, elektrostatski plastificiran. **Predspojne naprave:** Integrirana visoko efikasna predspojna naprava konstantnog izlaza (FO-DS) ili dimabilna (DALI-DS, TD, Casambi). Odvojeno paljenje. **Napajanje:** 230 V 50 Hz.



Mocca

Be bold or italic. Never regular.

3 reasons to be happy

Mocca goes beyond black and white, presenting a simple design and a colour accent that underlines everything Mocca stands for. It's 100% a designer's piece that can easily provide high-quality lighting with a combination of direct and indirect illumination, which makes Mocca your next favourite companion.

It's perfect for offices or hotel receptions because of its looks that can be easily incorporated into any interior, and because of its high visual comfort and low glare. Mocca doesn't need a flattering presentation. It's charming enough by itself.

3 razlogi za srečo

Mocca presega osnovno črno-belo kombinacijo in v prostor prinaša nove barvne odtenke. Je elegantno, posebno, 100 % dizajnersko svetilo, ki poleg vsega zagotavlja še popolno kombinacijo med direktno in indirektno osvetlitvijo, zaradi česar je Mocca dobrodošla v vsakem delovnem okolju.

Je popolna izbira za pisarne in hotelske recepcije, pa ne le zaradi svojega univerzalnega videza, ki se z lahkoto prilagaja različnim interierjem, temveč tudi zato, ker nudi visoko vizualno obdobje in nizek nivo bleščanja. Mocca ne potrebuje laskanja. Sama po sebi je dovolj očarljiva.

3 razloga za srečo

Mocca nadlazi crno-bijelo, s jednostavnim dizajnom i naglaskom na boje, koji naglašavaju sve što Mocca predstavlja. Ovo je 100 % dizajnerski proizvod koji može lako osigurati visoku kvalitetu rasvjete kombinacijom izravnog i neizravnog osvjetljenja, što čini Mocca vašim sljedećim omiljenim prijateljem.

Savršen je za urede ili hotelske recepcije zbog izgleda, koji se vrlo lako može uklopiti u bilo koji interijer, visoke vizualne udobnosti i niske razine bliještanja. Mocca ne treba laskavu prezentaciju. Dovoljno je šarmantna.







MAIN FEATURES

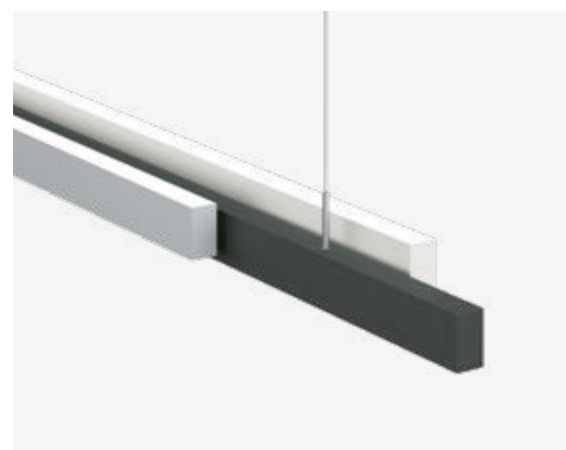

Indirect²

For all those indirect light lovers, this is the product for you. Create a softer light environment or combine direct and indirect illumination.

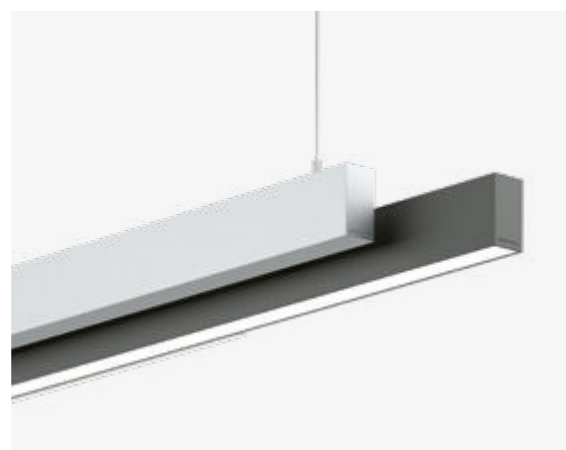

Different point of view, different look

It's like having two different luminaires. You can choose among three colour combinations where the sequence of colours is predefined.

Mocca

Technical Overview



FAMILY MEMBER

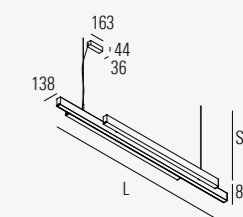

TECH. SPECS

LUMINAIRE LUMINOUS FLUX	LIGHT DISTRIBUTION	OPTICS	LENGTH (L)
5500 - 8900 lm	Direct / Indirect	DPR, SOP	1695 - 1975 mm
LED COLOUR	DRIVER	SUSPENSION HEIGHT (SH)	
827, 830, 835, 840, 930, 940, Tunable white 2700-6500 K	Casambi, DALI, FO, TD	1500, 3000, 5000 mm	

COLOURS

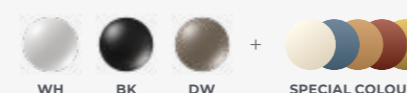

Light source: High-flux PCB LED modules, mid-power SMD LED, CRI>80/90, MacAdam≤2, 50.000h L90 B10 at 35°C. **Optic:** Satin opal diffuser (SOP) or soft-light prismatic optics (DPR) from polycarbonate for direct light. Satin opal polycarbonate diffuser (SOP) for indirect light. **Body:** Extruded aluminium profile, powder coated. **Control gear:** Integrated highly-efficient driver with fixed output (FO-DS) or dimmable (DALI-DS, TD, Casambi) - separate switching. **Power supply:** 230V 50Hz.

Svetlobni vir: PCB LED moduli visoke svetilnosti, z SMD LED, CRI>80/90, barvno odstopanje MacAdam≤2, 50.000 h L90 B10 na 35 °C. **Optika:** Satinirani opalni polikarbonatni difuzor (SOP) ali mikro-prizmatična difuzna PMMA optika (DPR) za direktno osvetlitev in opalni polikarbonatni difuzor (SOP) za indirektno osvetlitev. **Ohišje:** Ekstrudiran profil iz aluminija, prašno barvan. **Napajalnik:** Integriran visoko učinkoviti LED konverter s konstantnim tokom (FO-DS) ali regulacijskim izhodom (DALI-DS, TD, Casambi) - ločeno prižiganje. **Napajanje:** 230 V 50 Hz.

Izvor svetla: PCB LED moduli velikog svetlosnog toka, SMD LED srednje snage, CRI>80/90, MacAdam≤2, 50.000 h L90 B10 na 35 °C. **Optika:** Satinirani opalni difuzor (SOP) ili polikarbonatna prizmatična optika (DPR) za direktnu komponentu. Satinirani opalni polikarbonatni difuzor (SOP) za indirektnu komponentu. **Kućište:** Ekstrudirani aluminijски profil, elektrostatski plastificiran. **Predspojne naprave:** Integrirana visoko efikasna predspojna naprava konstantnog izlaza (FO-DS) ili dimabilna (DALI-DS, TD, Casambi). Odvojeno paljenje. **Napajanje:** 230 V 50 Hz.



Camay

Timeless elegance

Some want it glassy and classy

The inspiration behind the Camay range was to create a glass element to match with modern architecture, following the latest interior design trends.

With its timeless elegant form and detail, Camay is always a perfect choice in offices, shops, hotels or residential areas.

Nekateri želijo stekleno in klasično

Pri razvoju svetila Camay nas je vodila želja, ustvariti steklen element, ki se bo ujema z moderno arhitekturo in bo sledil najsodobnejšim trendom oblikovanja notranjih prostorov.

S svojo brezčasno elegantno obliko in detajli je Camay vedno dobra izbira v pisarnah, trgovinah, hotelih in bivalnih prostorih.

Neki vole staklasto i otmjeno

Nadahnuće koje stoji iza Camay linije proizvoda, bilo je stvoriti stakleni element koji odgovara modernoj arhitekturi, slijedeći najnovije trendove dizajna interijera.

Svojom bezvremenom elegantnim oblikom i detaljem, Camay je uvijek savršen izbor u uredima, dućanima, hotelima ili privatnim prostorima.



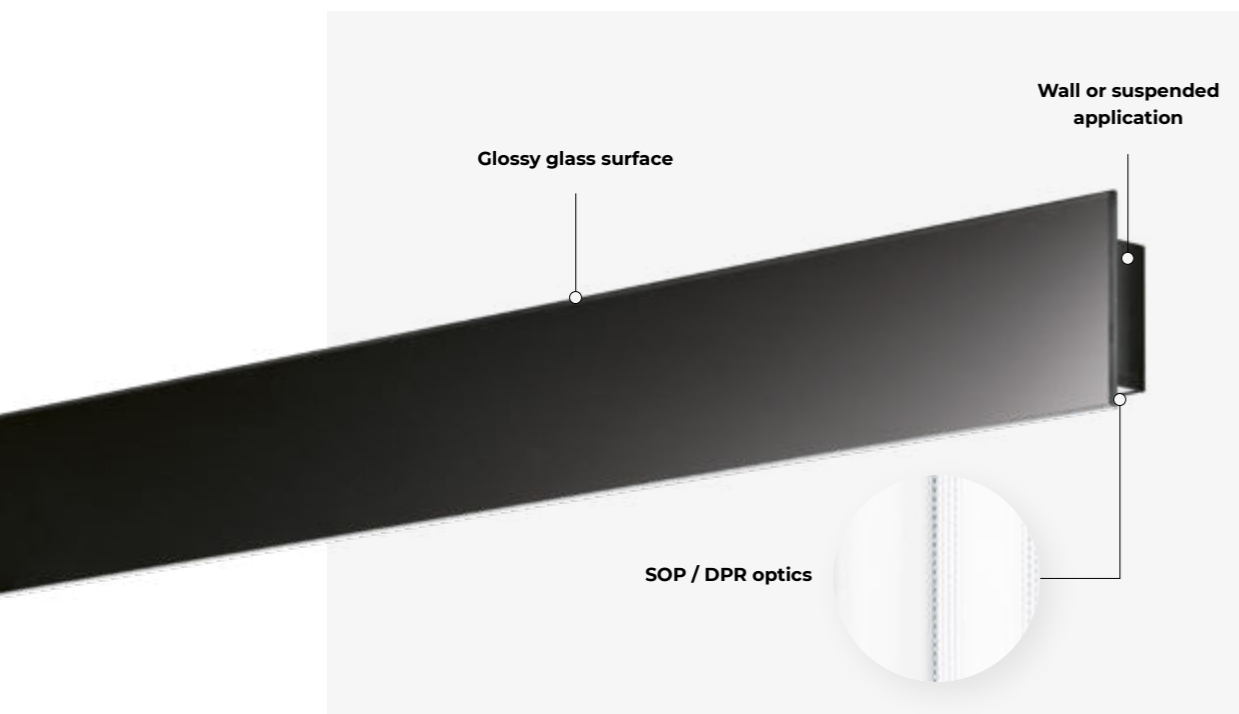

MAIN FEATURES



Glassy and classy

Bringing a timeless note, elegance and a glossy finish to match modern architecture.

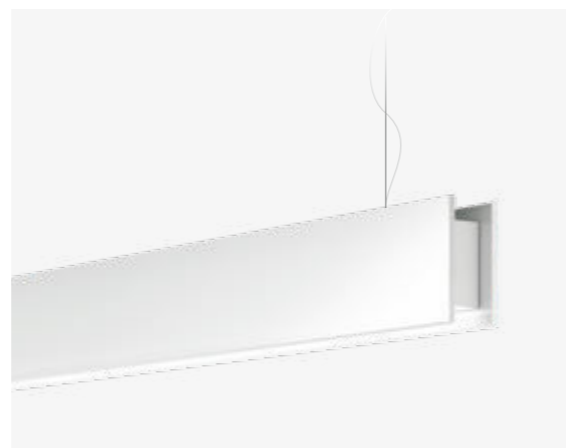

Direct / Indirect

Combine indirect and direct lighting to create spaciousness in offices and conference rooms.

Camay

Technical Overview



	S Suspended Direct	SDI Suspended Direct / Indirect	W Wall Direct	WDI Wall Direct / Indirect
Luminaire luminous flux	790 - 4700 lm	1350 - 8400 lm	790 - 4300 lm	1600 - 8800 lm
Light distribution	Direct	Direct / Indirect	Direct	Direct / Indirect
DLOR/ULOR*	-	55 / 45 %	-	50 / 50 %
Optics	DPR, SOP	DPR, SOP	SOP	SOP
LED colour	827, 830, 835, 840, 930, 940	827, 830, 835, 840, 930, 940	827, 830, 835, 840, 930, 940	827, 830, 835, 840, 930, 940
Dynamic illumination	Tunable white 2700 - 6500 K	Tunable white 2700 - 6500 K	Tunable white 2700 - 6500 K	Tunable white 2700 - 6500 K
Driver	Casambi, DALI, FO, TD	Casambi, DALI, FO, TD	Casambi, DALI, FO, TD	Casambi, DALI, FO, TD
Colour	1 2	1 2	1 2	1 2
Dimensions	L (mm): 885 - 1725 SH (mm): 1500, 3000, 5000	L (mm): 885 - 1725 SH (mm): 1500, 3000, 5000	L (mm): 885 - 1725	L (mm): 885 - 1725

* Data refer to model L1445mm, 840 medium output, SOP diffuser

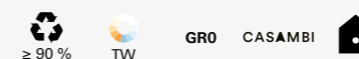

Light source: High-flux PCB LED modules, mid-power SMD LED, CRI>80/90, MacAdam≤2, 50.000h L90 B10 at 35°C. **Optic:** Satin opal diffuser (SOP) or soft-light prismatic optics (DPR) from polycarbonate for direct light. Satin opal polycarbonate diffuser (SOP) for indirect light. **Body:** Extruded aluminium profile with decorative glass side plate, powder coated. **Control gear:** Integrated highly-efficient driver with fixed output (FO) or dimmable (DALI-TD, Casambi). Optional separate switching for direct / indirect versions. **Power supply:** 230V 50Hz.

Svetlobni vir: PCB LED moduli visoke svetilnosti, z SMD LED, CRI>80/90, barvno odstopanje MacAdam≤2, 50.000 h L90 B10 na 35 °C. **Optika:** Satinirani opalni polikarbonatni difuzor (SOP) ali mikro-prizmatična difuzna PMMA optika (DPR) za direktno osvetlitev in opalni polikarbonatni difuzor (SOP) za indirektno osvetlitev. **Ohišje:** Ekstrudiran profil iz aluminija, prašno barvan z dekorativno stekleno stransko ploščo. **Napajalnik:** Integriran visoko učinkoviti LED konverter s konstantnim tokom (FO) ali regulacijskim izhodom (DALI-TD, Casambi). Opcijsko ločeno prižigavanje direktne / indirektno komponente. **Napajanje:** 230 V 50 Hz.

Izvor svetla: PCB LED moduli velikog svetlosnog toka, SMD LED srednje snage, CRI>80/90, MacAdam≤2, 50.000 h L90 B10 na 35 °C. **Optika:** Satinirani opalni difuzor (SOP) ili polikarbonatna prizmatična optika (DPR) za direktno komponentu. Satinirani opalni polikarbonatni difuzor (SOP) za indirektno komponentu. **Kućište:** Kućište od ekstrudiranog aluminijevog profila s bočnim stranicama od dekorativnog stakla. **Predspojne naprave:** Integrirana visoko efikasna predspojna naprava konstantnog izlaza (FO) ili dimabilna (DALI-TD, Casambi). Odvojeno paljenje direktne/indirektno komponente na zahtjev. **Napajanje:** 230 V 50 Hz.



Kalis

Absolutely universal

Like a little black dress, for any occasion

Kalis family range is so universal and flexible, that even with repetition of the same product, individuality and originality can be achieved on projects.

The basic shape, which allows the creation of infinite patterns, the ability to match and its carefully designed details give Kalis the potential to become one of your favourites.

Kot mala črna obleka, za vsako priložnost

Družina Kalis je do te mere univerzalna in fleksibilna, da lahko tudi s ponavljanjem enakih svetil dosežemo individualnost in izvirnost rešitve projekta.

Primarna oblika, ki omogoča ustvarjanje neskončnih vzorcev, sposobnost kombiniranja in skrbno oblikovani detajli umeščajo Kalis med svetila, ki lahko postanejo vaša najljubša izbira.

Poput male crne haljine, za svaku priložnost

Raspon obitelji Kalis je tako univerzalan i fleksibilan da se čak i ponavljanjem istog proizvoda može postići individualnost i originalnost na projektima.

Osnovni oblik, koji omogućuje stvaranje bezbrojnih uzoraka, mogućnost kombiniranja i njegovi pažljivo oblikovani detajli, daju Kalisu potencijal da postane jednim od vaših omiljenih.







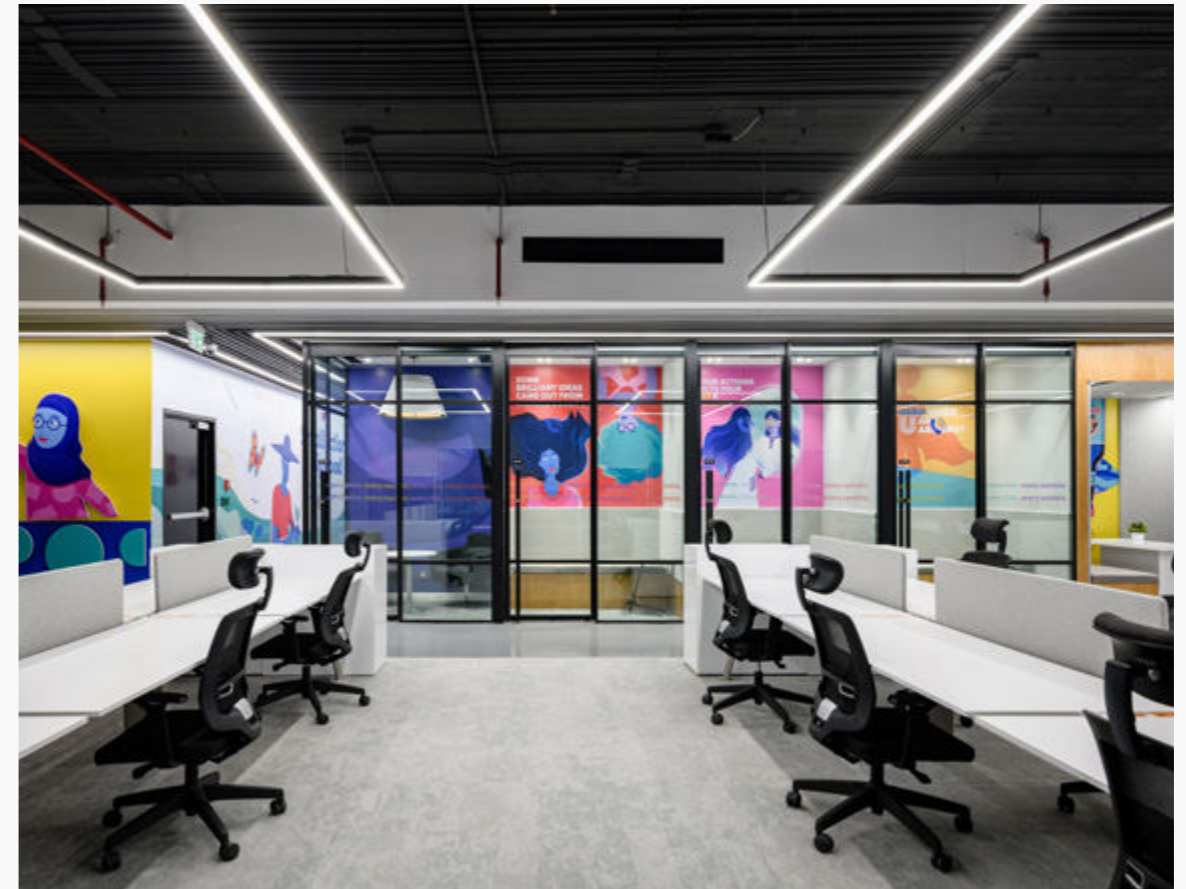







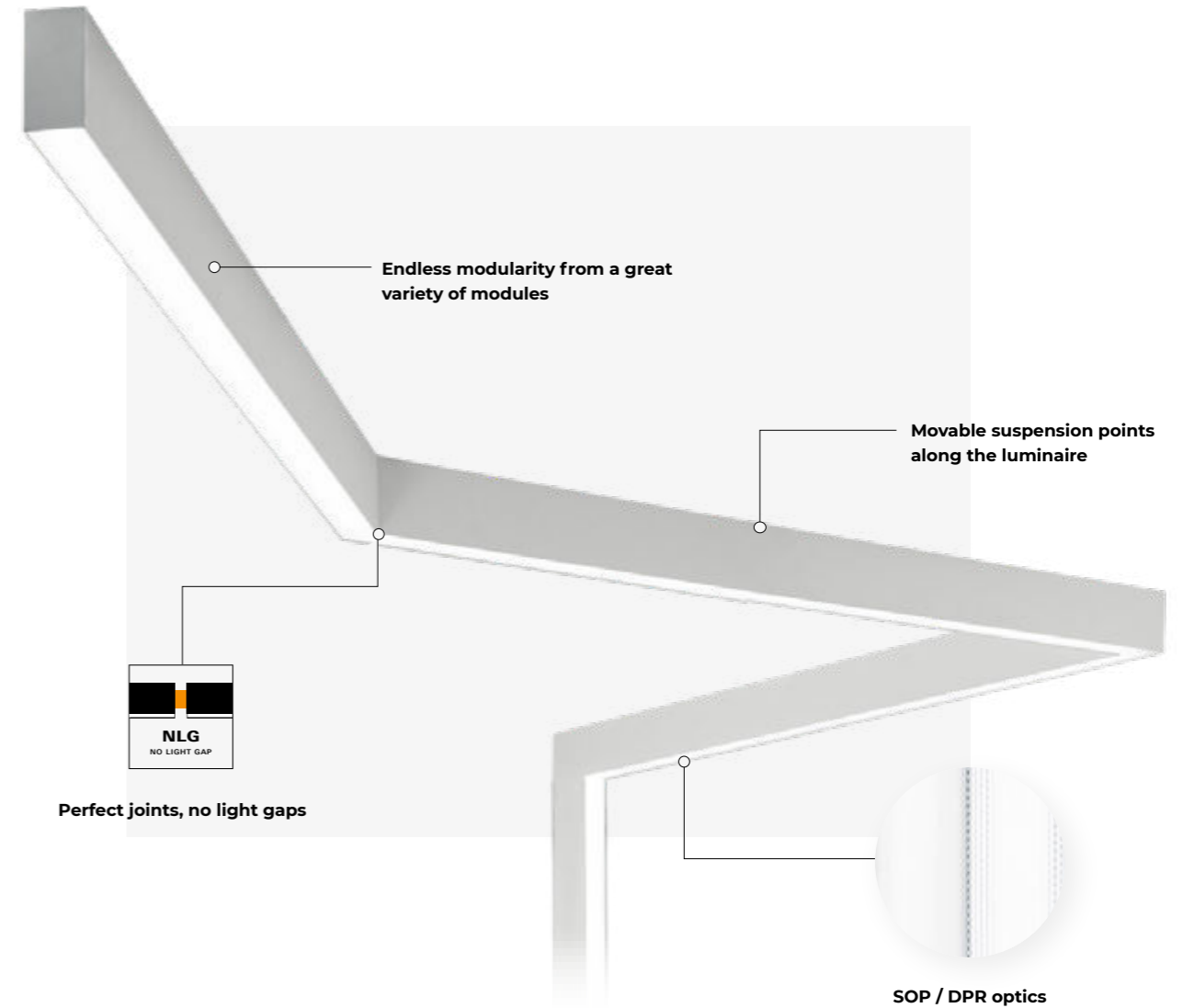

MODULE TYPES

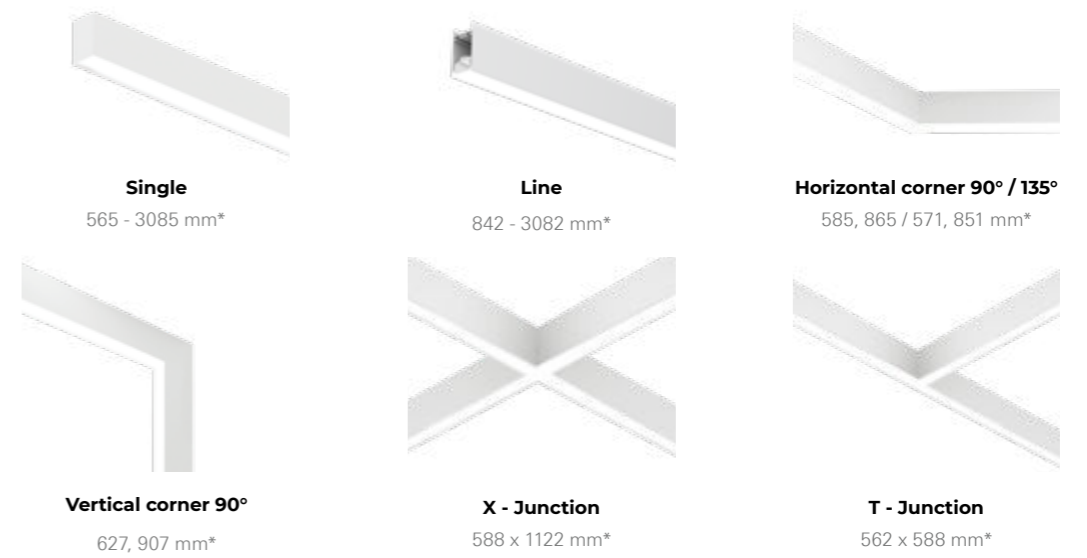

* The lengths refer to the C/S 65 version.

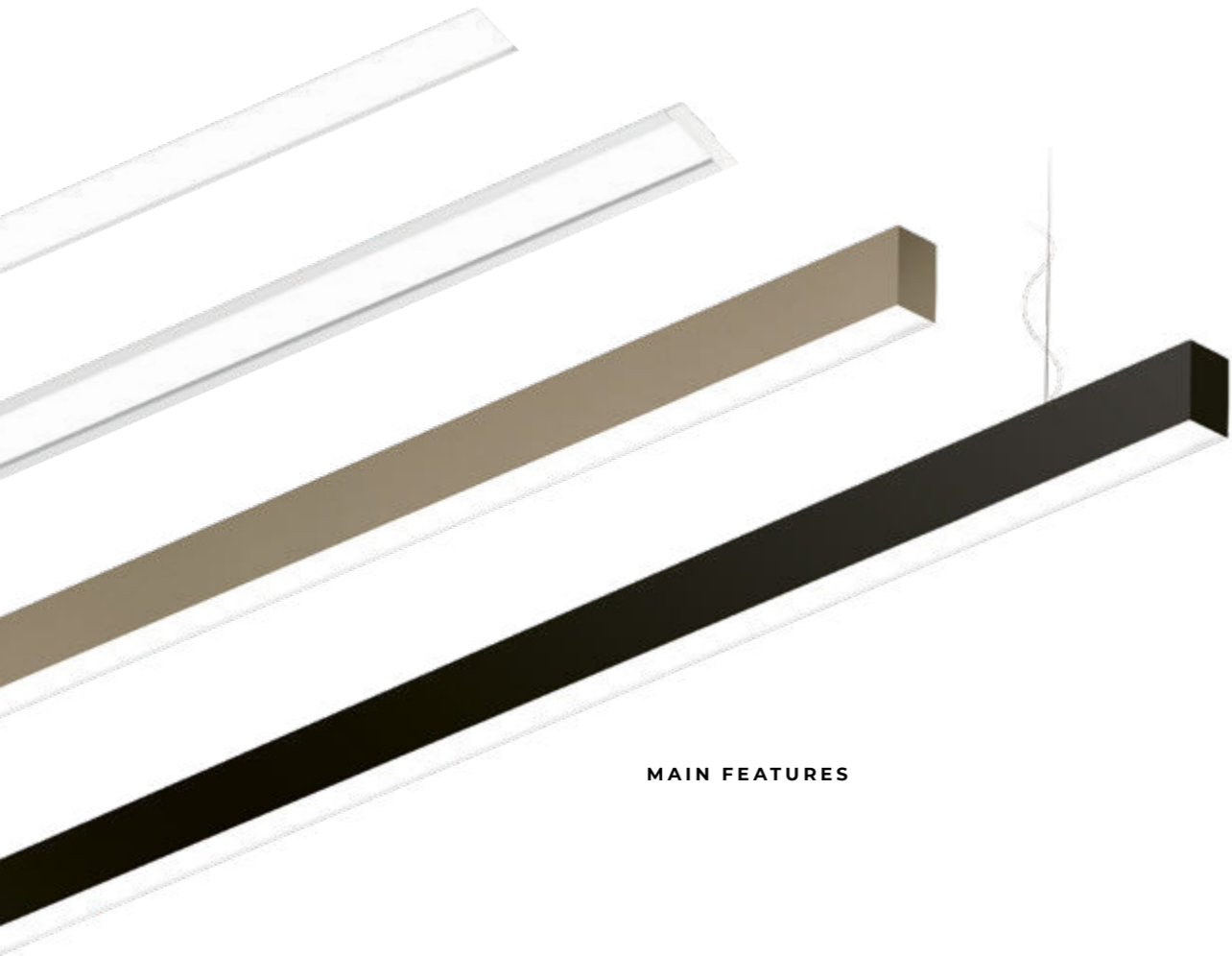

MAIN FEATURES

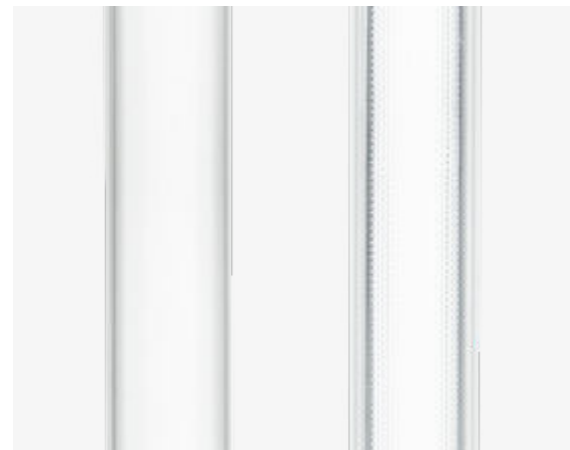

General or task illumination?

Use satin opal polycarbonate diffuser (SOP) for general illumination or soft-light prismatic optics (DPR) for task illumination.

Kalis with spot

When you want to combine general and spot illumination, use Kalis with a spot (to be ordered separately).

Find out more in Atos family on p. 345.

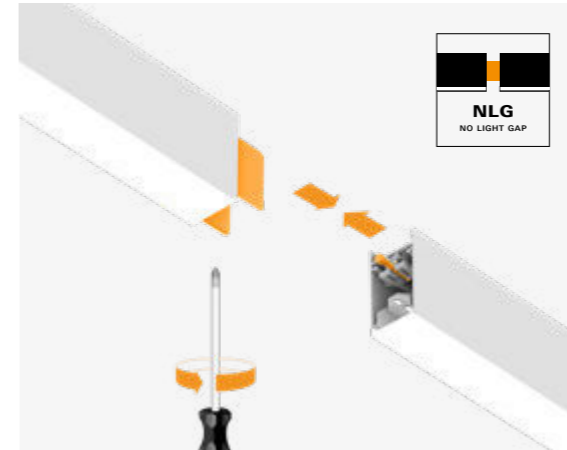

Perfect joints, no light gaps

With an innovative twist and lock side shader, the assembly between two modules is now quick and easy, and the profiles are strongly connected with no risk of bending. The light has absolutely no possibilities to escape.

Movable suspension points

The suspension can be moved along the luminaire to ensure optimal mounting on your ceiling. Only one suspension per joint is needed instead of two. In case of indirect illumination movement is limited.

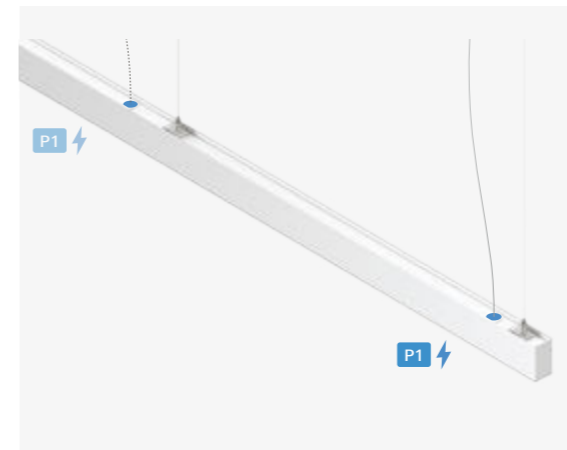
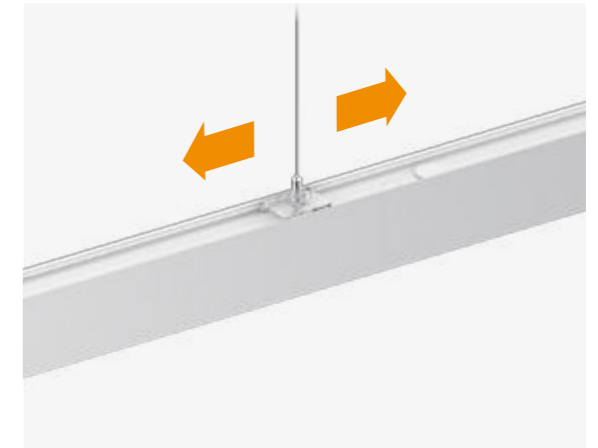

Multiple power-in position

Power feed cables can be used on each luminaire in the system. You can choose the power-in position that suits you best. If necessary, one extensive system can be reconfigured into smaller ones with individual power-in points.

Easy and fast construction with Intra Constructor PRO

Design Kalis in Intra Constructor PRO quickly, easily and without errors. The tool offers maximum flexibility, so while constructing you can easily change, add, remove or adjust modules and features.



Kalis

Technical Overview



KALIS 55



KALIS 65

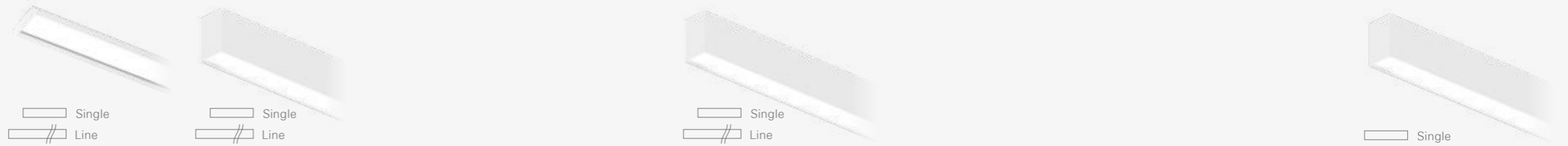

	RI Recessed trim-less	RV Recessed visible trim	C/S Ceiling / Suspended	S 36 Suspended	SDI Suspended Direct / Indirect	T Track	W Wall direct	WDI Wall Direct / Indirect
Luminaire luminous flux/m	980 - 2850 lm/m	980 - 2850 lm/m	980 - 2850 lm/m	1100 - 2900 lm/m	1650 - 5300 lm/m	1150 - 2850 lm/m	1000 lm/m	2000 lm/m
Light distribution	Direct	Direct	Direct	Direct	Direct / Indirect	Direct	Direct	Direct / Indirect
DLOR/ULOR*	-	-	-	-	52 / 48 %	-	-	49 / 51 %
Optics	DPR, SOP	DPR, SOP	DPR, SOP	DPR, SOP	DPR, SOP	DPR, SOP	SOP	SOP
LED colour	827, 830, 835, 840, 930, 940	827, 830, 835, 840, 930, 940	827, 830, 835, 840, 930, 940	827, 830, 835, 840, 930, 940	827, 830, 835, 840, 930, 940	827, 830, 835, 840, 930, 940	827, 830, 835, 840, 930, 940	827, 830, 835, 840, 930, 940
Dynamic illumination	Tunable white 2700 - 6500K	Tunable white 2700 - 6500K	Tunable white 2700 - 6500K	-	Tunable white 2700 - 6500K	Tunable white 2700 - 6500K	Tunable white 2700 - 6500K	Tunable white 2700 - 6500K
Driver	Casambi, DALI, FO	Casambi, DALI, FO	Casambi, DALI, FO	DALI, FO	Casambi, DALI, FO, TD	Casambi, DALI, FO	Casambi, DALI, FO, TD	Casambi, DALI, FO, TD
Emergency kit	EM 1h / 3h	EM 1h / 3h	EM 1h / 3h	-	EM 1h / 3h (Line)	-	-	-
IP protection	IP20/IP44** (Line: IP20/IP43**)	IP20/IP44** (Line: IP20/IP43**)	IP44/IP20*** (Line: IP20)	IP20	IP20	IP20	IP44	IP40
Colour	1	1 2	See the colour options below	See the colour options below	See the colour options below	1 2	See the colour options below	See the colour options below

Dimensions	L (mm): 565 - 3085	L (mm): 575 - 3095	L (mm): 565 - 3085	L (mm): 1125 - 1965 SH (mm): 1500, 3000, 5000	L (mm): 845 - 3085 SH (mm): 1500, 3000, 5000	L (mm): 565 - 1965	L (mm): 565 - 3085	L (mm): 845 - 3085

* Data refer to model L1405mm, 840 medium output, SOP diffuser. ** IP value from the exposed side. *** IP value for suspended mounting.



Light source: High-flux PCB LED modules, mid-power SMD LED, CRI>80/90, MacAdam≤2, 50.000h L80 B10 at 35°C. **Optic:** Satin opal diffuser (SOP) or soft-light prismatic optics (DPR) from polycarbonate for direct light. Satin opal polycarbonate diffuser (SOP) for indirect light. **Body:** Extruded aluminium profile, powder coated. **Ceiling cup:** For suspended versions, the ceiling cup and suspension set must be ordered separately (except Kalis 36). Find out more on the technical pages or online product configurator. **Control gear:** Integrated highly-efficient driver with fixed output (FO) or dimmable (DALI-TD, Casambi). Optional separate switching for direct / indirect versions. **Emergency:** Emergency kit version with autonomy 1h or 3h. **Power supply:** 230V 50Hz.

Svetlobni vir: PCB LED moduli visoke svetilnosti, z SMD LED, CRI>80, barvno odstopanje MacAdam≤2, 50.000 h L80 B10 na 35 °C. **Optika:** Satinirani opalni polikarbonatni difuzor (SOP) ali mikro-prizmatična difuzna PMMA optika (DPR) za direktno osvetlitev in opalni polikarbonatni difuzor (SOP) za indirektno osvetlitev. **Ohišje:** Ekstrudiran profil iz aluminija, prašno barvan. **Stropna rozeta:** Za viseče verzije se rozete in vešala naročajo posebej (razen za Kalis 36). Več na straneh s tehnično vsebino ali v spletnem konfiguratorju. **Napajalnik:** Integriran visoko učinkoviti LED konverter s konstantnim tokom (FO) ali regulacijskim izhodom (DALI-TD, Casambi). Opcijsko ločeno prižiganje direktne / indirektno komponente. **Varnostni modul:** Varnostni modul z 1 ali 3 urami avtonomije. **Napajanje:** 230 V 50 Hz.

Standard: **1 2 3 6 9** Special colours:

Izvor svetla: PCB LED moduli velikog svetlosnog toka, SMD LED srednje snage, CRI>80, MacAdam≤2, 50.000 h L80 B10 na 35 °C. **Optika:** Satinirani opalni difuzor (SOP) ili polikarbonatna prizmatična optika (DPR) za direktnu komponentu. Satinirani opalni polikarbonatni difuzor (SOP) za indirektnu komponentu. **Kućište:** Ekstrudirani aluminijski profil, elektrostatski plastificiran. **Stropna rozeta:** Za ovesne inačice, stropna rozeta i ovesni pribor moraju biti naručeni zasebno (osim Kalisa 36). Otkrij više na tehničkim stranicama ili online konfiguratoru proizvoda. **Predspojne naprave:** Integrirana visoko efikasna predspojna naprava konstantnog izlaza (FO) ili dimabilna (DALI-TD, Casambi). Odvojeno paljenje direktne/indirektno komponente na zahtjev. **Režim nužne rasvjete:** Modul nužne rasvjete avtonomije 1 ili 3 h. **Napajanje:** 230 V 50 Hz.



Random

Not random at all

You're going to love your second ceiling

Random is created to enhance the look of modern open ceilings, turning them into something dynamic! And it all starts with using straight lines and bringing them together into a composition that works best in open spaces that need a secondary ceiling.

This luminaire is a perfect fit for retail, modern offices and even hospitality environments, not only because of its distinctive look, but also because of high-quality general illumination that's an absolute must for every highly efficient environment. And when you get to know it, you will definitely agree that creating a secondary ceiling has never been so elegant.

Oboževali boste svoj drugi strop

Namen svetila Random je, da priljubljenim visokim stropom z vidno inštalacijo doda dinamiko in estetiko. Vse se začne s sestavljanjem ravnih linij v kompozicijo, primerno za odprte prostore, ki potrebujejo drugi strop.

Popolno je za trgovine, pisarne, hotele, pa ne le zaradi izgleda, temveč ker zagotavlja tudi zelo kakovostno osvetlitev, ki je pravzaprav osnovni pogoj za vsako dobro delovno in bivalno okolje. In ko boste enkrat spoznali svetilo Random, se boste prepričali, da ustvarjanje sekundarnega stropa še nikoli ni bilo tako elegantno.

Voljet ćete svoj drugi strop

Random je stvoren kako bi obogatilo izgled modernih otvorenih stropova, pretvarajući ih u nešto dinamično! I sve to počinje korištenjem ravnih linija i njihovim povezivanjem u sastav koji najbolje odgovara otvorenim prostorima koji trebaju sekundarni strop.

Ovo rasvjetno tijelo savršen je pogodak za prodajne objekte, moderne urede, pa čak i bolničko okruženje, ne samo zbog karakterističnog izgleda, već i zbog visokokvalitetnog općeg osvjetljenja koje je svakako potrebno za svaku iznimno učinkovitu sredinu. A kad ga upoznate, definitivno ćete se složiti da stvaranje sekundarnog stropa nikad nije bilo tako elegantno.





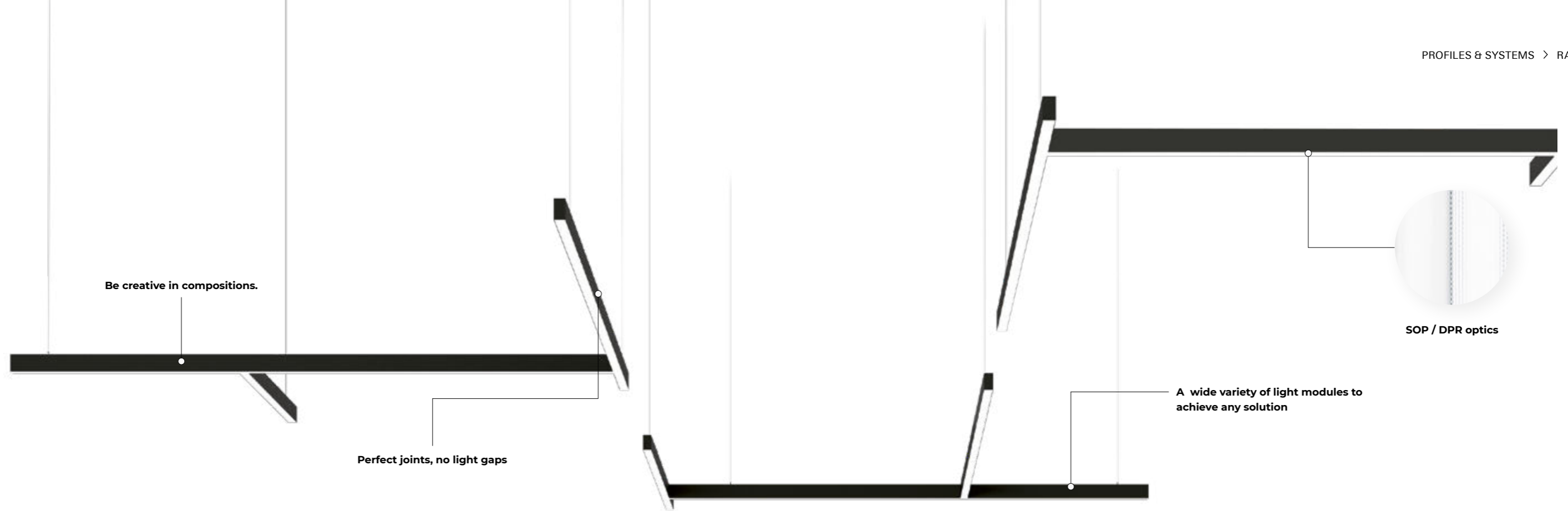

MAIN FEATURES

Easy and fast construction with Intra Constructor PRO

Design Random in Intra Constructor PRO quickly, easily and without errors. The tool offers maximum flexibility, so while constructing you can easily change, add, remove or adjust modules and features.



Multiple power-in position

Power feed cables can be used on each luminaire in the system. You can choose the power-in position that suits you best. If necessary, one extensive system can be reconfigured into smaller ones with individual power-in points.

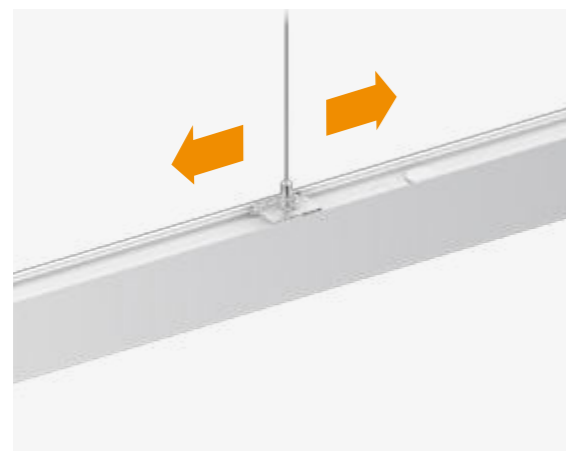
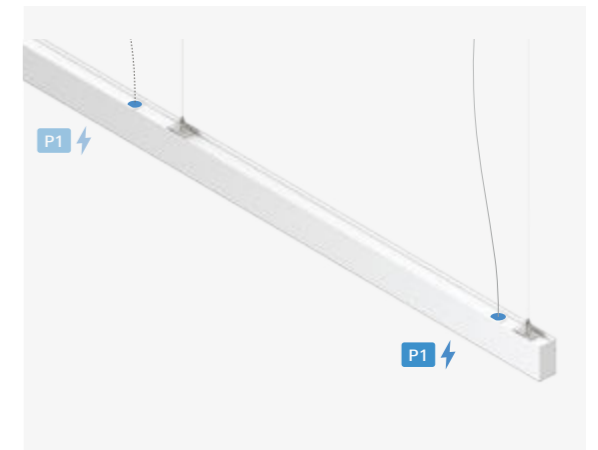

Movable suspension points

The suspension can be moved along the luminaire to ensure optimal mounting on your ceiling. Only one suspension per joint is needed instead of two. In case of indirect illumination movement is limited.

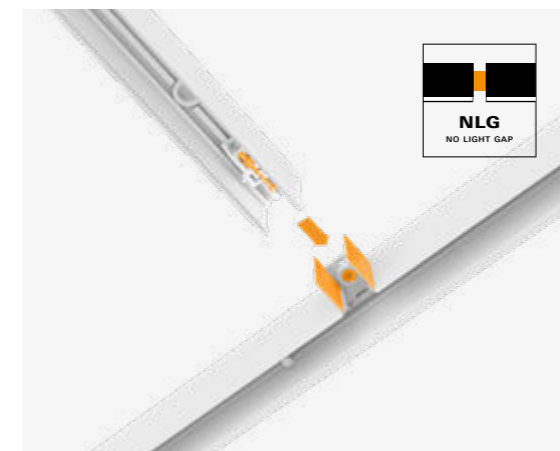

Perfect joints, no light gaps

With an innovative twist and lock joint element, the assembly between two modules is now quick and easy, and the profiles are strongly connected with no risk of bending. The light has absolutely no possibilities to escape.

Random

Technical Overview



	S Suspended Direct	SDI Suspended Direct / Indirect
Luminaire luminous flux/m	980 - 2000 lm/m	1650 - 3700 lm/m
Light distribution	Direct	Direct / Indirect
DLOR/ULOR*	-	55 / 45 %
Optics	DPR, SOP	DPR, SOP
LED colour	827, 830, 835, 840, 930, 940	827, 830, 835, 840, 930, 940
Dynamic illumination	Tunable white 2700 - 6500K	Tunable white 2700 - 6500K
Driver	DALI, FO	DALI, FO
Colour	1 2	1 2
Dimensions	L (mm): 844 - 2807 SH (mm): 1500, 3000, 5000	L (mm): 844 - 2807 SH (mm): 1500, 3000, 5000

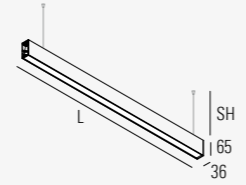
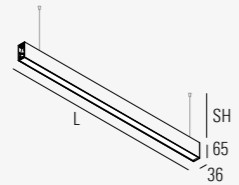

* Data refer to model L1407mm, 840 medium output, SOP diffuser.



Light source: High-flux PCB LED modules, mid-power SMD LED, CRI>80/90, MacAdam≤2, 50.000h L80 B10 at 35°C. **Optic:** Satin opal diffuser (SOP) or soft-light prismatic optics (DPR) from polycarbonate for direct light. Satin opal polycarbonate diffuser (SOP) for indirect light. **Body:** Extruded aluminium profile, powder coated. **Ceiling cup:** For suspended versions, the ceiling cup and suspension set must be ordered separately. Find out more on the technical pages or online product configurator. **Control gear:** Integrated highly-efficient driver with fixed output (FO) or dimmable (DALI-TD, Casambi). Optional separate switching for direct / indirect versions. **Power supply:** 230V 50Hz.

Svetlobni vir: PCB LED moduli visoke svetilnosti, z SMD LED, CRI>80, barvno odstopanje MacAdam≤2, 50.000 h L80 B10 na 35 °C. **Optika:** Satinirani opalni polikarbonatni difuzor (SOP) ali mikro-prizmatična difuzna PMMA optika (DPR) za direktno osvetlitev in opalni polikarbonatni difuzor (SOP) za indirektno osvetlitev. **Ohišje:** Ekstrudirani profil iz aluminija, prašno barvan. **Stropna rozeta:** Za viseče verzije se rozete in vešala naročajo posebej. Več na straneh s tehnično vsebino ali v spletnem konfiguratorju. **Napajalnik:** Integriran visoko učinkoviti LED konverter s konstantnim tokom (FO) ali regulacijskim izhodom (DALI-TD, Casambi). Opcijsko ločeno prižiganje direktne / indirektno komponente. **Napajanje:** 230 V 50 Hz.

Izvor svetla: PCB LED moduli velikog svetlosnog toka, SMD LED srednje snage, CRI>80, MacAdam≤2, 50.000 h L80 B10 na 35 °C. **Optika:** Satinirani opalni difuzor (SOP) ili polikarbonatna prizmatična optika (DPR) za direktnu komponentu. Satinirani opalni polikarbonatni difuzor (SOP) za indirektnu komponentu. **Kućište:** Ekstrudirani aluminijски profil, elektrostatски plastificiran. **Stropna rozeta:** Za ovesjne inačice, stropna rozeta i ovesjni pribor moraju biti naručeni zasebno. Otkrij više na tehničkim stranicama ili online konfiguratoru proizvođača. **Predspojne naprave:** Integrirana visoko efikasna predspojna naprava konstantnog izlaza (FO) ili dimabilna (DALI-TD, Casambi). Odvojeno paljenje direktne/indirektno komponente na zahtjev. **Napajanje:** 230 V 50 Hz.

SYSTEM EXAMPLE

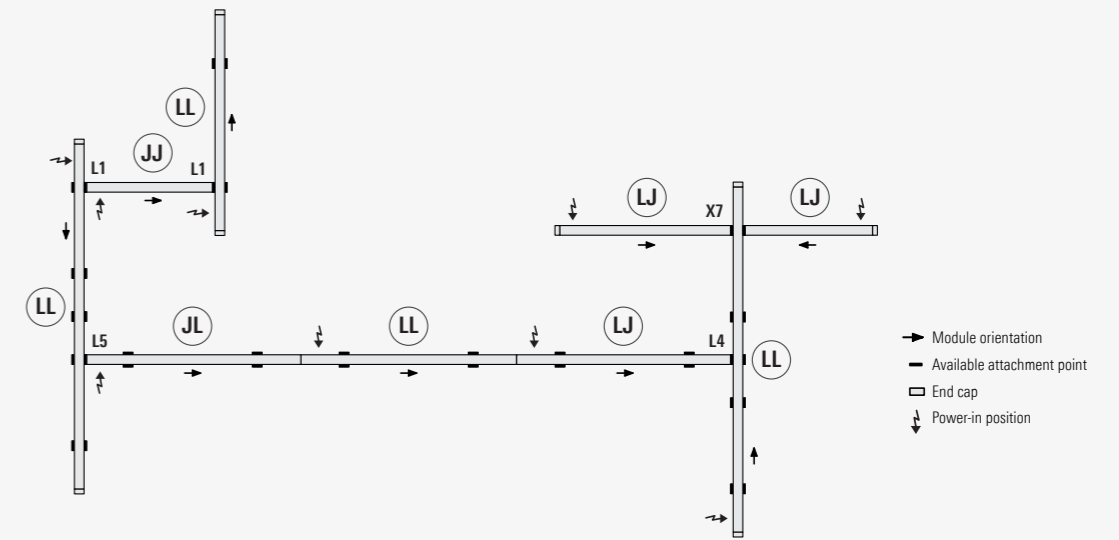

MODULES AND USAGE

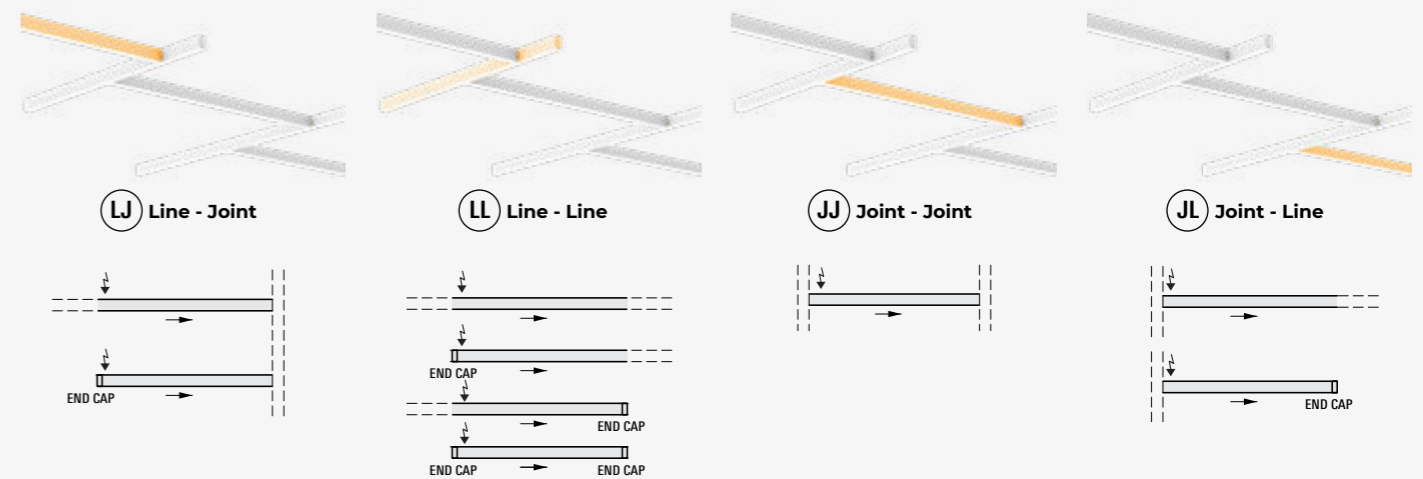

JOINT POSITIONS AND DIMENSIONS

Module length (mm)	Max no. of joints / module *
844	0
1124	0
1404	2
1684	2
2244	3
2804	3

Joint position (mm)	Available attachment point
282	L1
842	R3
1122	L3, R4
1402	L4, R5
1962	L5, R7
2522	L7, R9

*Adding modules on the left and on the right side on the same position, counts as one joint per module and it's marked with X+joint position (X4). The joint X is possible 1x/ module.

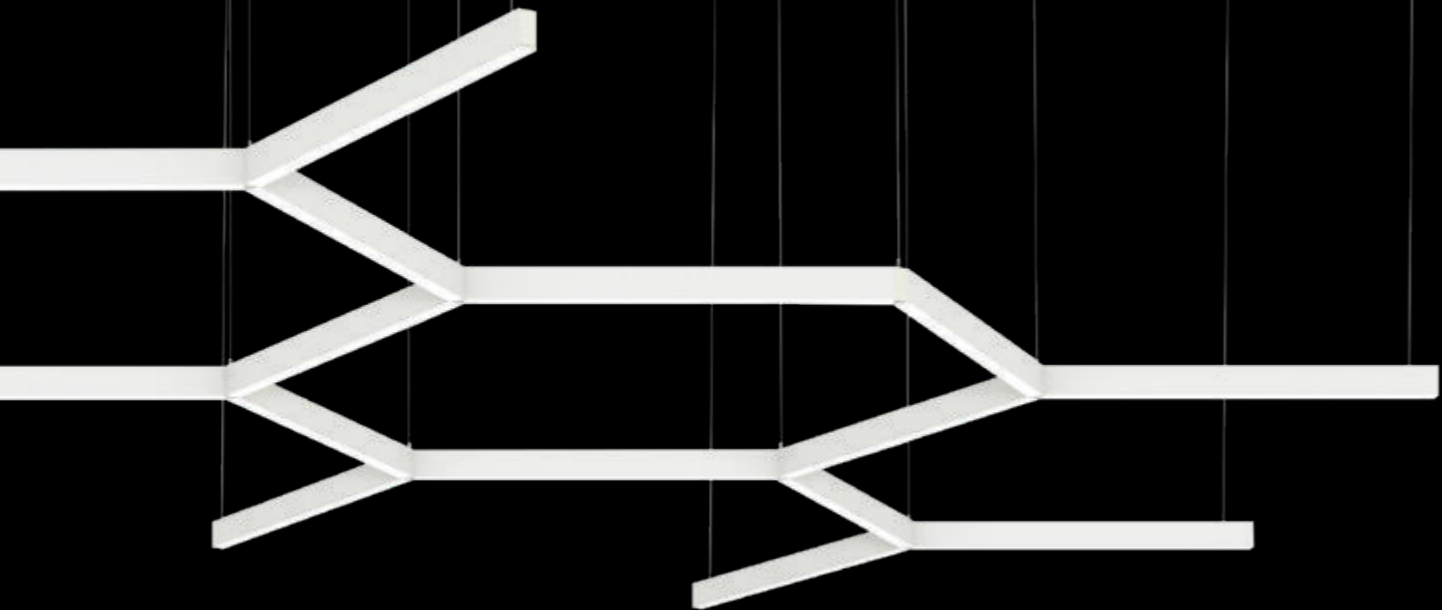

Hexagon

Don't be a square

This will make you look up

With Hexagon S the magic starts with using basic shapes and joining them together into a net-like composition that works best as a secondary ceiling. It's the perfect pick for all those projects that go beyond functionality and seek an element with a distinctive look. And it's not only that ... Hexagon is a luminaire that offers far more! It does not only guarantee high-quality general illumination, but also leaves you all the creativity to make it as big and as bold as you want.

When we created Hexagon, we were thinking about modern open-space offices, retail and even hospitality, and if you're planning on placing Hexagon in one of your spaces, you will be surprised to find out that creating a secondary ceiling has never been so cool.

Svetilo, ki z lahkoto pritegne vašo pozornost

Pri Hexagonu se čarovnija začne z združevanjem osnovnih linij v obliko panja, ki učinkuje kot sekundaren strop. Je popolna izbira za tiste projekte, ki presegajo golo uporabnost in iščejo elemente z značilnim videzom. Še več, Hexagon ne ponuja le visoke kakovosti svetlobe, ampak vaši ustvarjalnosti pušča odprte roke.

Ko smo razvijali Hexagon, smo imeli v mislih sodobne odprte pisarne, trgovine, hotele. In če razmišljate, da bi ga umestili v enega od vaših prostorov, boste presenečeni, ko boste ugotovili, da postavljanje nadomestnega stropa še nikoli ni bilo tako zabavno.

Ovo će vas natjerati da podignete pogled

S Hexagon S magija započinje korištenjem osnovnih oblika i njihovim spajanjem u mrežni sastav koji najbolje djeluje kao sekundarni strop. Ovo je savršen odabir za sve one projekte koji nadilaze funkcionalnost i traže element s karakterističnim izgledom. I ne samo to... Hexagon je rasvjetno tijelo koje nudi mnogo više! Ne samo da garantira visoku kvalitetu opće osvjetljenosti, već svu kreativnost ostavlja vama, kako biste je učinili velikom i hrabrom onoliko koliko želite.

Kad smo stvorili Hexagon, razmišljali smo o modernim otvorenim uredima, prodajnim prostorima, pa čak i prostorima za odmor, a ako planirate staviti Hexagon u jedan od vaših prostora, bit ćete iznenađeni kada saznate da stvaranje sekundarnog stropa nikada nije bilo tako cool.









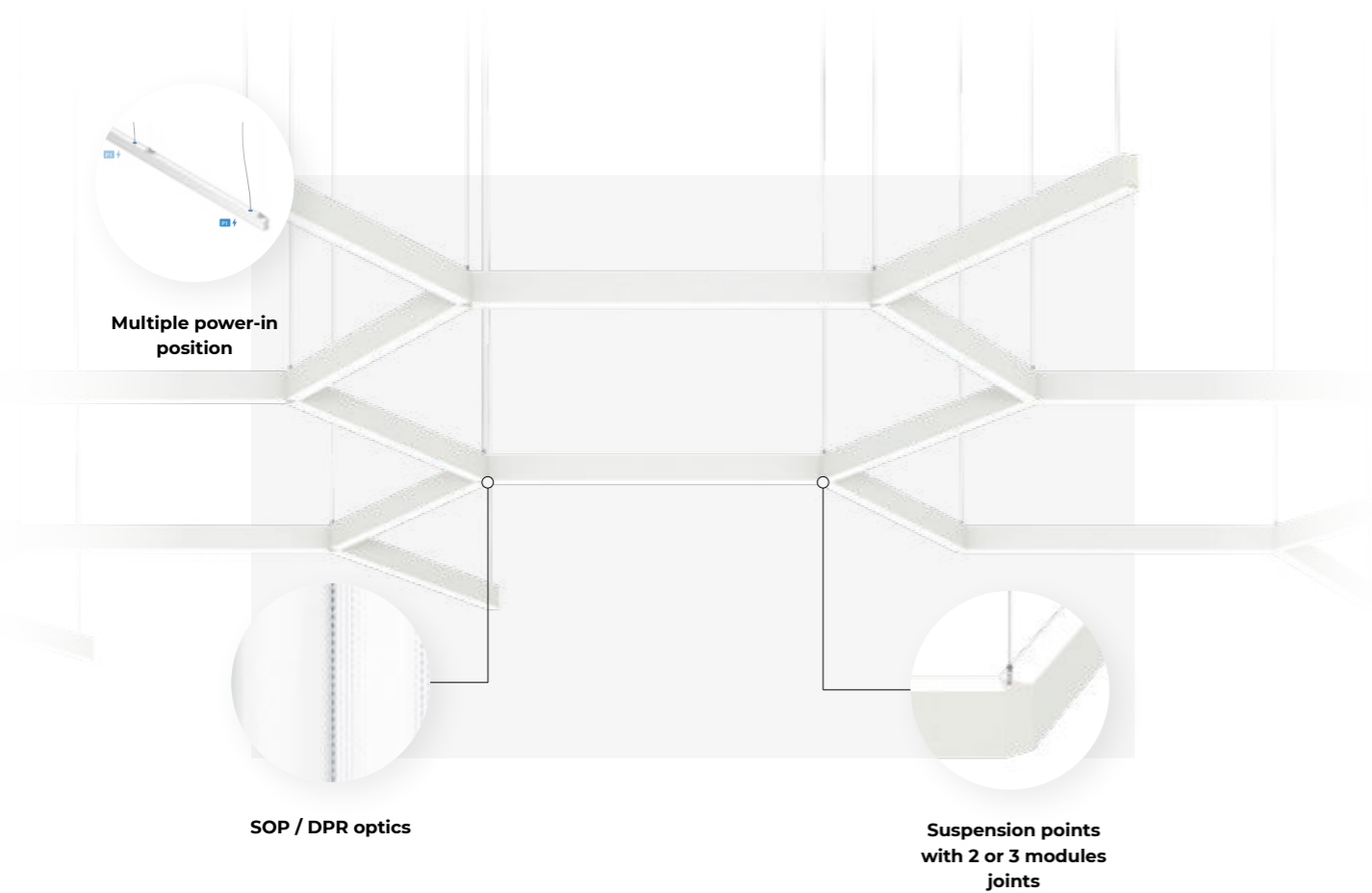

MODULE DIMENSIONS AND JOINT TYPES

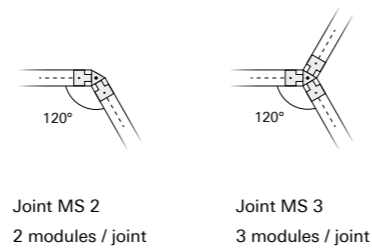
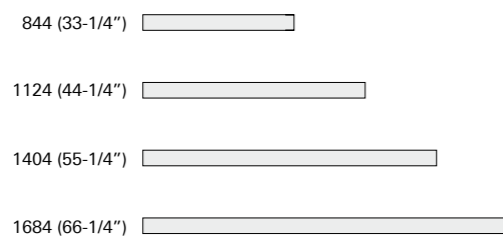

Be creative in compositions

Get inspired and draw your light. Integrate it in to the space and give your visitors a reason to look up. Hexagon offers maximum application possibilities.

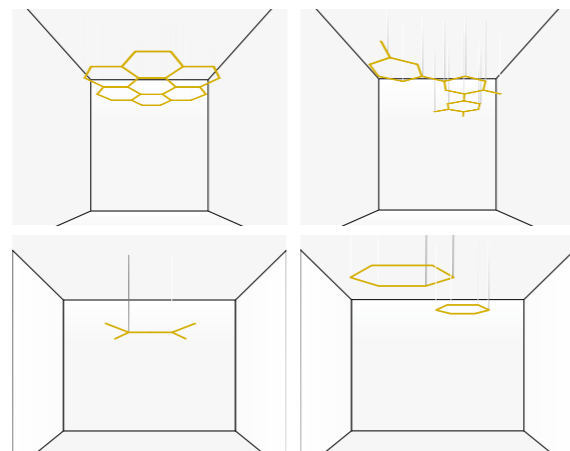

Hexagon

Technical Overview

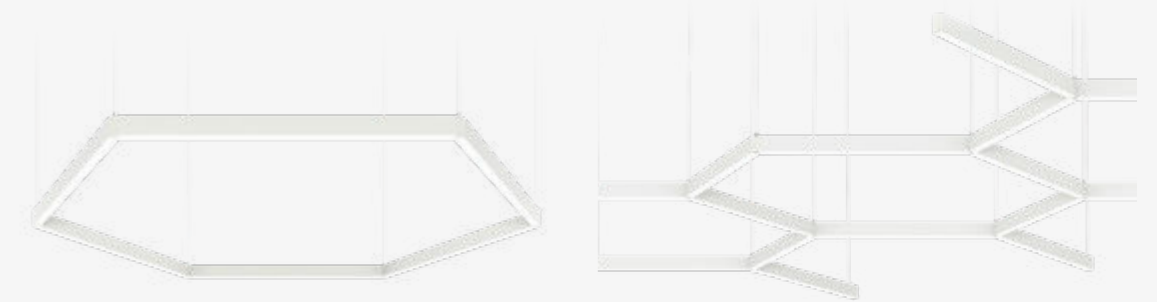

	S Suspended Direct	SDI Suspended Direct / Indirect	S MESH Suspended Direct	SDI MESH Suspended Direct / Indirect
Luminaire luminous flux	3300 - 14300 lm	5000 - 16300 lm	980 - 2800 lm/m	1650 - 5000 lm/m
Light distribution	Direct	Direct / Indirect	Direct	Direct / Indirect
Optics*	DPR, SOP	DPR, SOP	DPR, SOP	DPR, SOP
LED colour	827, 830, 835, 840, 930, 940	827, 830, 835, 840, 930, 940	827, 830, 835, 840, 930, 940	827, 830, 835, 840, 930, 940
Dynamic illumination	Tunable white 2700 - 6500K	Tunable white 2700 - 6500K	Tunable white 2700 - 6500K	Tunable white 2700 - 6500K
Driver	Casambi, DALI, FO	Casambi, DALI, FO, TD	DALI, FO	DALI, FO, TD
Colour	1 2	1 2	1 2	1 2
Dimensions	L (mm): 1199, 1759 SH (mm): 1500, 3000, 5000	L (mm): 1199, 1759 SH (mm): 1500, 3000, 5000	L (mm): 848 - 1688 SH (mm): 1500, 3000, 5000	L (mm): 848 - 1688 SH (mm): 1500, 3000, 5000

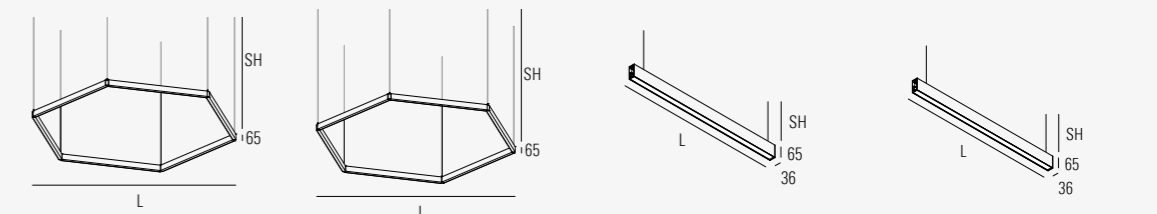

Light source: High-flux PCB LED modules, mid-power SMD LED, CRI>80/90, MacAdam≤2, 50.000h L80 B10 at 35°C. **Optic:** Satin opal diffuser (SOP) or soft-light prismatic optics (DPR) from polycarbonate for direct light. Satin opal polycarbonate diffuser (SOP) for indirect light. **Body:** Extruded aluminium profile, powder coated. **Ceiling cup:** For suspended versions, the ceiling cup and suspension set must be ordered separately. Find out more on the technical pages or online product configurator. **Control gear:** Integrated highly-efficient driver with fixed output (FO) or dimmable (DALI-TD, Casambi). Optional separate switching for direct / indirect versions. **Power supply:** 230V 50Hz.

Svetlobni vir: PCB LED moduli visoke svetilnosti, z SMD LED, CRI>80, barvno odstopanje MacAdam≤2, 50.000 h L80 B10 na 35 °C. **Optika:** Satinirani opalni polikarbonatni difuzor (SOP) ali mikro-prizmatična difuzna PMMA optika (DPR) za direktno osvetlitev in opalni polikarbonatni difuzor (SOP) za indirektno osvetlitev. **Ohišje:** Ekstrudiran profil iz aluminija, prašno barvan. **Stropna rozeta:** Za viseče verzije se rozete in vešala naročajo posebej. Več na straneh s tehnično vsebino ali v spletnem konfiguratorju. **Napajalnik:** Integriran visoko učinkoviti LED konverter s konstantnim tokom (FO) ali regulacijskim izhodom (DALI-TD, Casambi). Opcijsko ločeno prižiganje direktne / indirektno komponente. **Napajanje:** 230 V 50 Hz.

Izvor svetla: PCB LED moduli velikog svetlosnog toka, SMD LED srednje snage, CRI>80, MacAdam≤2, 50.000 h L80 B10 na 35 °C. **Optika:** Satinirani opalni difuzor (SOP) ili polikarbonatna prizmatična optika (DPR) za direktnu komponentu. Satinirani opalni polikarbonatni difuzor (SOP) za indirektnu komponentu. **Kućište:** Ekstrudirani aluminijски profil, elektrostatски plastificiran. **Stropna rozeta:** Za ovesne inačice, stropna rozeta i ovesni pribor moraju biti naručeni zasebno. Otkrij više na tehničkim stranicama ili online konfiguratoru proizvođača. **Predspojne naprave:** Integrirana visoko efikasna predspojna naprava konstantnog izlaza (FO) ili dimabilna (DALI-TD, Casambi). Odvojeno paljenje direktne/indirektno komponente na zahtjev. **Napajanje:** 230 V 50 Hz.



Rylo Pro

Office first

Your best office buddy

Whether it is suspended, recessed or floor, Rylo Pro is mostly intended for offices – for single ones, open spaces and conference rooms, offering illumination with no glare, high visual comfort and wellbeing.

The floor version of Rylo Pro is really practical: no installation needed, just plug-in and start. It is easy to move from one workstation to another.

Vaš najboljši pisarniški kolega

Ne glede na to, ali je viseča, vgradna ali talna, je svetilka Rylo Pro večinoma namenjena pisarnam – individualnim, skupnim in konferenčnim sobam. Ponuja osvetljenje brez bleščanja, visoko vizualno udobje in dobro počutje.

Talna različica Rylo Pro je resnično praktična: montaža ni potrebna, samo vključite jo in prižgete. Premikanje z ene delovne postaje na drugo je preprosto.

Vaš najbolji uredski kolega

Bilo da je viseči, ugradbeni ili podni, Rylo Pro namenjen je uglavnom za poslovne prostore – obične urede, otvorene prostore i konferencijske sobe, u kojima postiže osvjetljenje bez odsjaja, visoku vizualnu udobnost i zadovoljstvo boravka.

Podna verzija Rylo Pro je izuzetno praktična: ne zahtijeva instalaciju, već samo priključak i pokretanje. Lako se premješta u poslovnim prostorima.



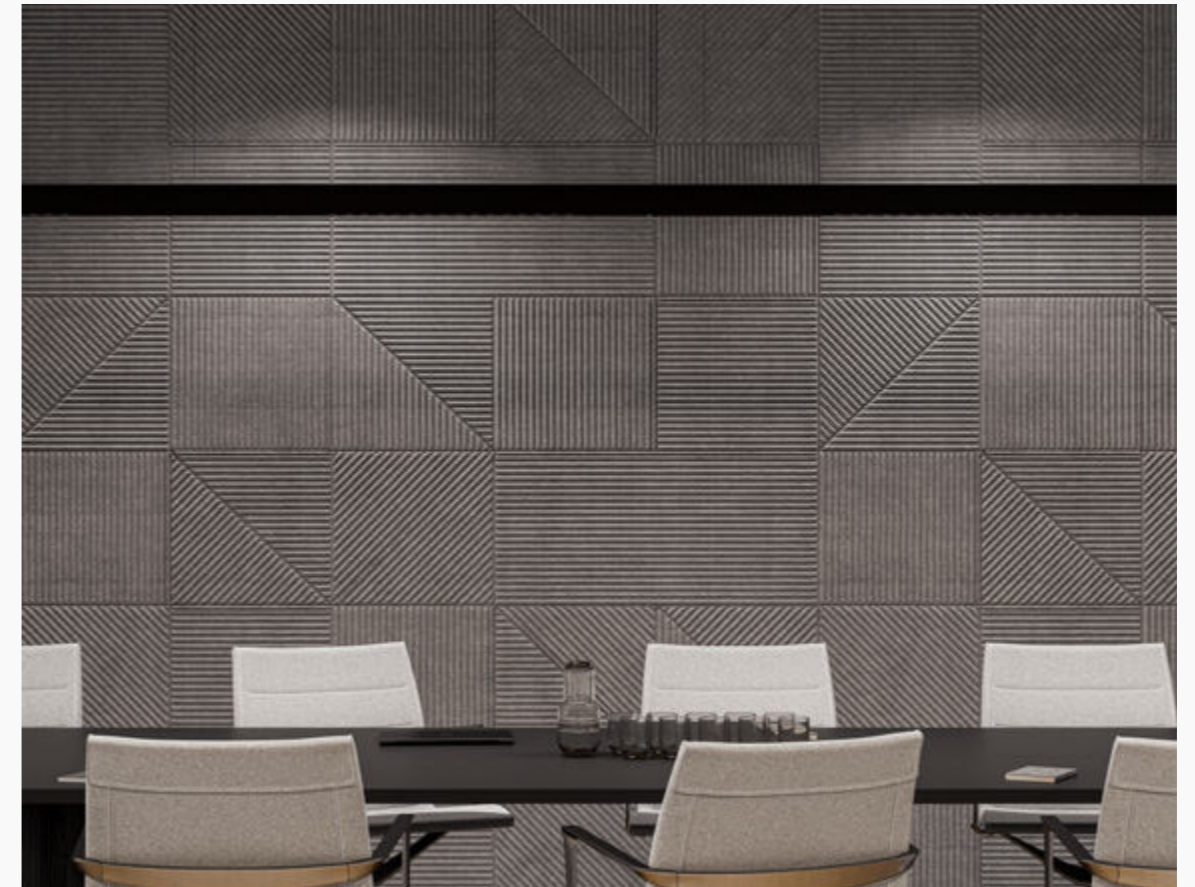



UGR
<19



MAIN FEATURES



Wide family range

The family range is wide – from single modules to linear systems, and also T forms for double desks.

No glare, light comfort

Inappropriate lighting causes headaches and eye trouble. Create a healthier working environment with lighting which affects our well-being, mood and concentration. With indirect illumination you can create a softer light environment.

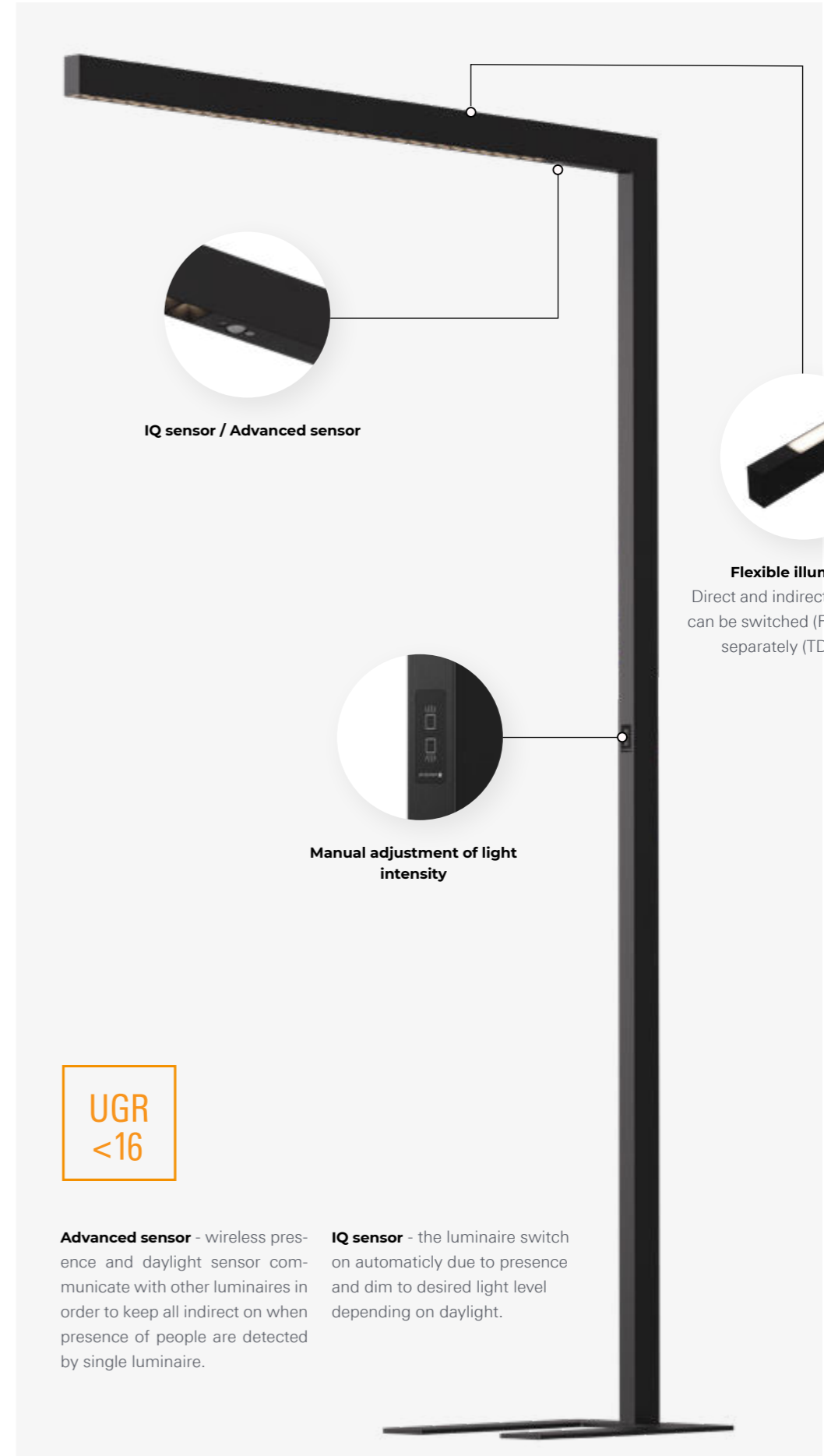
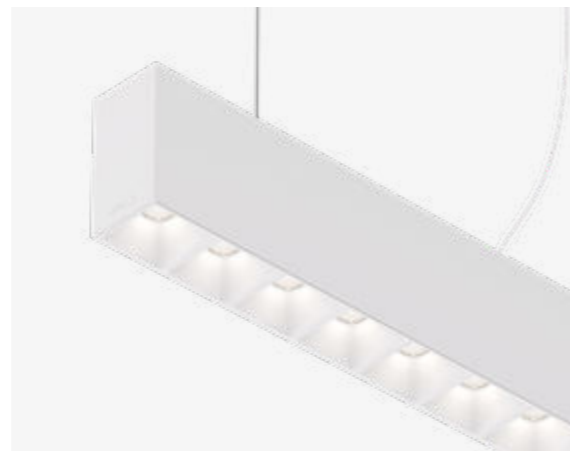

IQ sensor / Advanced sensor

Flexible illumination

Direct and indirect components can be switched (FO) or dimmed separately (TD version).

Manual adjustment of light intensity

UGR
<16

Advanced sensor - wireless presence and daylight sensor communicate with other luminaires in order to keep all indirect on when presence of people are detected by single luminaire.

IQ sensor - the luminaire switch on automatically due to presence and dim to desired light level depending on daylight.

Rylo Pro

Technical Overview

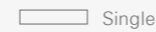
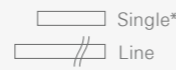
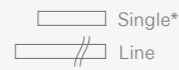
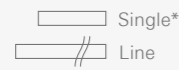

	RI Recessed trimm-less	RV Recessed visible trim	C/S Ceiling / Suspended	SDI Suspended direct-indirect	S/SDI Suspended direct / direct-indirect	FDI Floor direct-indirect	FDI T Floor direct-indirect T shape
Glare control (UGR class)	UGR<19	UGR<19	UGR<19	UGR<19	UGR<19	UGR<16	UGR<16
Luminaire luminous flux	34 - 167 lm/spot	34 - 167 lm/spot	34 - 167 lm/spot	34 - 167 lm/spot	34 - 167 lm/spot	1700 lm + 3600 lm for LED colour 930	3400 lm + 7200 lm for LED colour 930
Number of spots	8+8, 16+16	8+8, 16+16	8+8, 16+16	8+8, 16+16	8+8, 16+16	32	32+32
Light distribution	Direct	Direct	Direct	Direct / Indirect	Direct, Direct / Indirect	Direct / Indirect	Direct / Indirect
Optics	50°, Asymetric	50°, Asymetric	50°, Asymetric	50°, Asymetric	50°, Asymetric	50°	50°
LED colour	927, 930, 935, 940	927, 930, 935, 940	927, 930, 935, 940	927, 930, 935, 940	927, 930, 935, 940	927, 930, 935, 940	927, 930, 935, 940
Driver	Casambi, DALI, FO, IQ sensor	Casambi, DALI, FO, IQ sensor	Casambi, DALI, FO, IQ sensor	Casambi, DALI, FO, IQ sensor	Casambi, DALI, FO, IQ sensor	Casambi, FO, IQ sensor, TD	Casambi, FO, IQ sensor, TD
Driver position	Integrated	Integrated	Integrated	Integrated	Ceiling cup	Integrated	Integrated
Colour	1 2	1 2	See the colour options below	See the colour options below	See the colour options below	1 2	1 2
Dimensions	L (mm): 1682 - 3082	L (mm): 1682 - 3082	L (mm): 1682 - 3082	L (mm): 1962 - 3082 SH (mm): 1500, 3000, 5000	L (mm): 1125 - 2805 SH (mm): 1500, 3000, 5000		

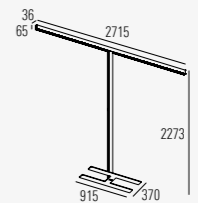
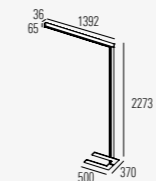
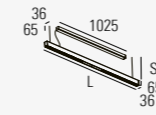
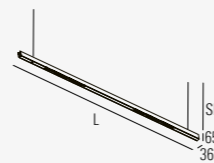
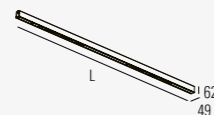
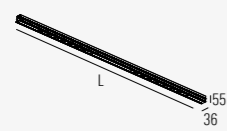

For C/S, SDI, S/SDI versions, the optical funnel and blind module colour are always black (except with the white version). *Single module is possible by adding end caps to the Line module.



GRO CASAMBI



Light source: High-flux PCB LED modules, mid-power SMD LED, CRI>90, MacAdam≤2, 50.000h L90 B10 at 35°C. / High-power LED, CRI>90, MacAdam≤2,5, 50.000h L80 B10 at 35°C. **Optic:** Low glare spot optical system with UGR<19. Satin opal polycarbonate diffuser (SOP) for indirect light. **Body:** Extruded aluminium profile, powder coated. **Control gear:** Integrated highly-efficient driver with fixed output (FO) or dimmable (DALI-TD, Casambi). Optional separate switching for direct / indirect versions. **Power supply:** 230V 50Hz.

Svetlobni vir: High-flux PCB LED moduli, z SMD LED, CRI>90, MacAdam≤2, 50.000 h L90 B10 na 35 °C. / Visoko učinkovit COB LED modul, CRI>90, barvno odstopanje MacAdam≤2,5, 50.000 h L80 B10 na 35 °C. **Optika:** Reflektorski optični sistem z omejenim bleščanjem UGR<19. Opalni polikarbonatni difuzor (SOP) za indirektno osvetlitev. **Ohišje:** Ekstrudiran profil iz aluminija, prašno barvan. **Napajalnik:** Integriran visoko učinkoviti LED konverter s konstantnim tokom (FO) ali regulacijskim izhodom (DALI-TD, Casambi). Opcijsko ločeno prižiganje direktne / indirektno komponente. **Napajanje:** 230 V 50 Hz.

Standard: 1 2 3 6 9 Special colours:

Izvor svetla: PCB LED moduli velikog svjetlosnog toka, SMD LED srednje snage, CRI>90, MacAdam≤2, 50.000 h L90 B10 at 35 °C. / LED COB velike snage, CRI>90, MacAdam≤2,5, 50.000 h L80 B10 at 35 °C. **Optika:** Reflektorski optički sistem s UGR<19. Satinirani opalni difuzor (SOP) za indirektnu komponentu. **Kućište:** Ekstrudirani aluminijски profil, elektrostatski plastificiran. **Predspojne naprave:** Integrirana visoko efikasna predspojna naprava konstantnog izlaza (FO) ili dimabilna (DALI-TD, Casambi). Odvojeno paljenje direktne/indirektno komponente na zahtjev. **Napajanje:** 230 V 50 Hz.



Lynar

It's your move

Sweet home for light modules

Lynar is an elegant, endless modular profile that offers maximum flexibility.

The choice of modules is wide and the installation is tool-free, simple, fast and safe. Combine them the way you want and change or move at anytime.

It covers a wide range of use - from office, galleries, retail, hospitality to private residences.

Varno zavetje svetilnih modulov

Lynar je eleganten, neskončen modularni profil, ki nudi maksimalno fleksibilnost.

Izbira modulov je bogata, montaža pa je možna brez orodja, je enostavna, hitra in varna. Kombinirajte jih tako, kot želite, in jih kadarkoli spremenite ali premaknite.

Zajema širok nabor uporabe – od pisarne, galerij, trgovin, gostinstva do zasebnih bivališč.

Slatki dom za svetlosne module

Lynar je elegantan, beskončan modularni profil koji nudi maksimalnu fleksibilnost.

Izbor modula je širok, a instalacija je bez alata, jednostavna, brza i sigurna. Kombinirajte ih, mijenjajte ili premještajte, na koje god načine želite.

Lynar pokriva širok raspon korištenja – od ureda, galerija, maloprodaje, ugostiteljstva do privatnih rezidencija.



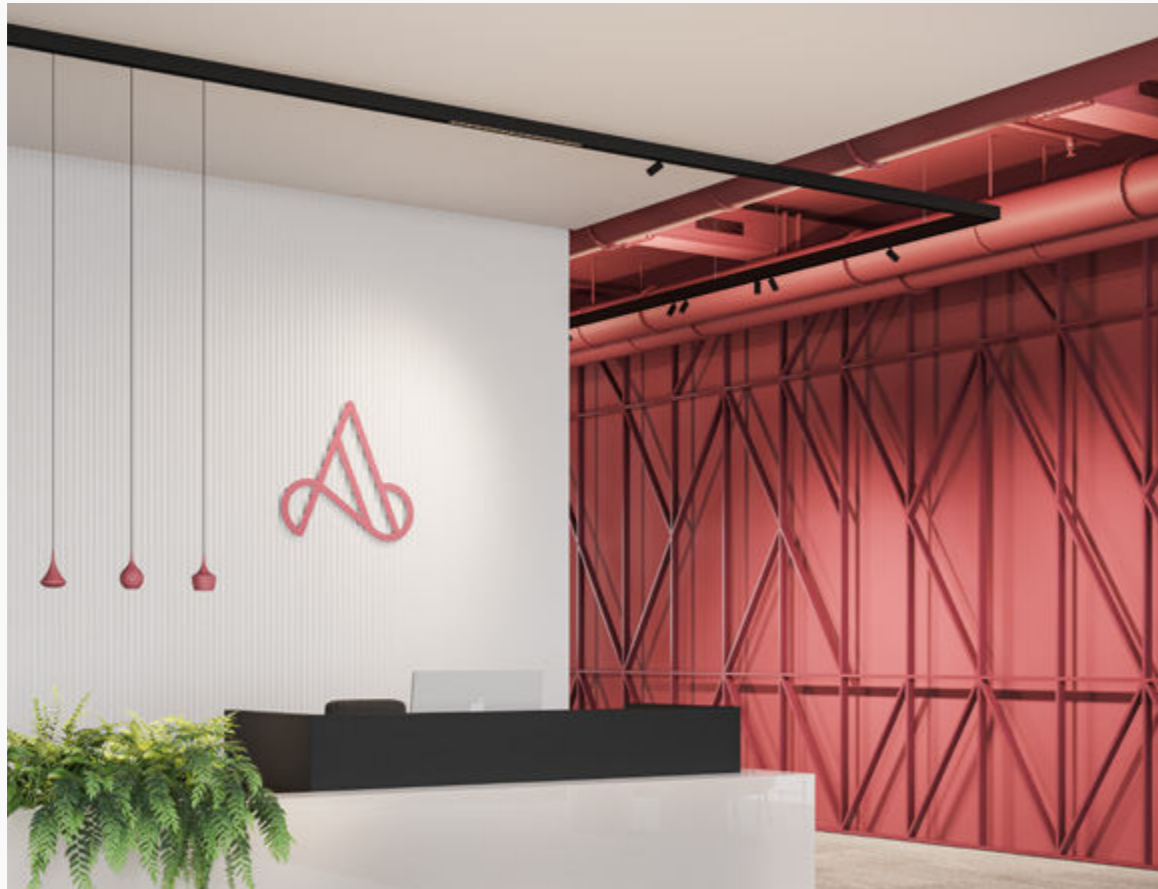



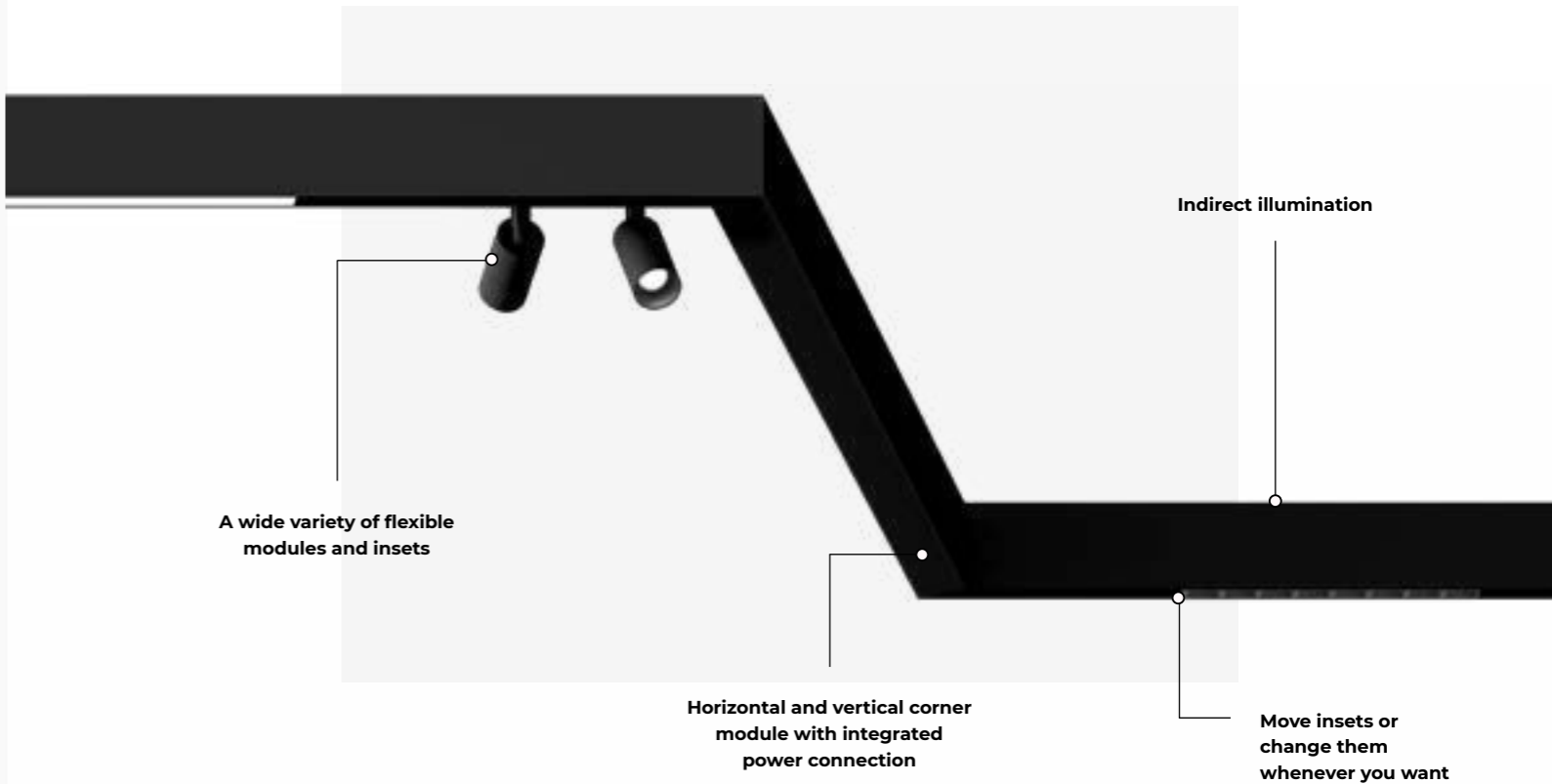

INSETS



Atos LYN



Eye LYN



Kalis 36 LYN



Rylo LYN



Rylo LYN WW



Biba LYN



Pipes 45 S LYN



Pixy LYN



Zoe LYN

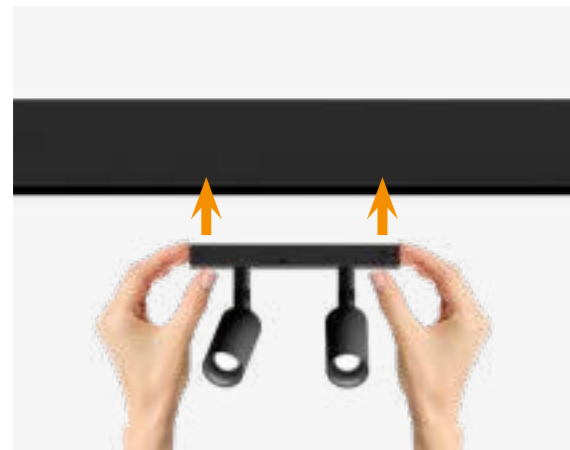

Quick installation

The installation of modules is simple, fast and safe. The products are fixed with a mechanical coupling that ensures a reliable and lifelong grip.



Light line

Choose Kalis inset for general illumination. It can turn out very well in a composition as an interesting graphic element.

Keep on moving

Get the maximum flexibility of adjusting the light in the space. Not just the first time, but anytime. Repositioning the modules has never been easier.

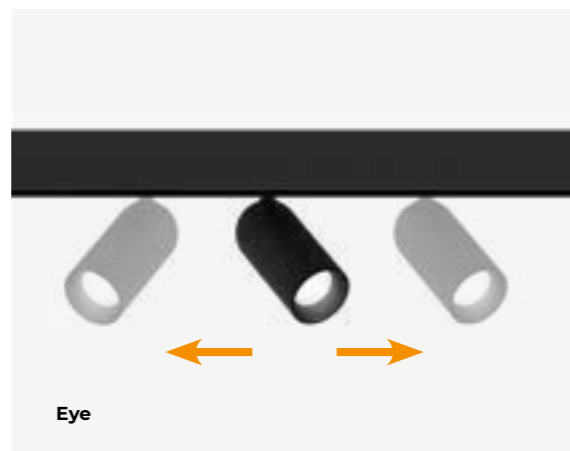

Internal or external power supply

Depending on the desired visual effect and profile installation type, the power supply can be positioned inside the profile, externally in the ceiling cup or remotely.

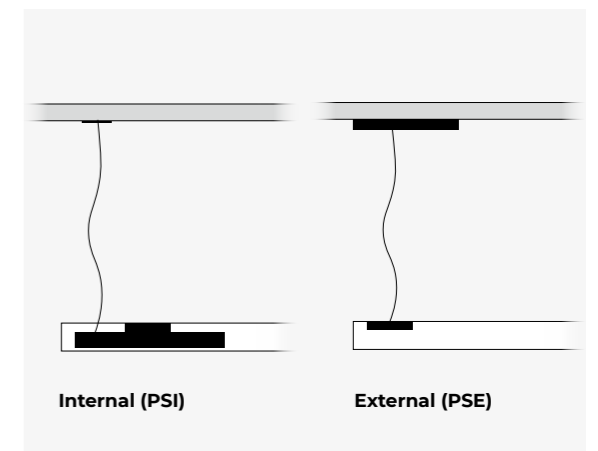

Lynar

Technical Overview



	RI Recessed trim-less	RV Recessed visible trim	C/S Ceiling / Suspended	SDI Suspended Direct / Indirect
Indirect luminaire luminous flux/m	-	-	-	990 lm/m (DALI)
LED colour	-	-	-	827, 830, 835, 840, 930, 940
Electrical connection	48Vdc (not included, order separately)	48Vdc (not included, order separately)	48Vdc (not included, order separately)	48Vdc (not included, order separately)
Colour	D	2	1 2 3 6 9 +	1 2 3 6 9 +
Dimensions	L: 500 - 3000 mm	L: 500 - 3000 mm	L: 500 - 3000 mm	L: 1000 - 3000 mm SH (mm): 1500, 3000, 5000

* The inner part of the profile is always black

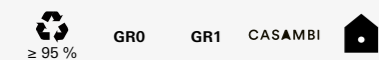

Linear extruded aluminium profile system with integrated 48V track. Indirect light option with SOP diffuser. Wide range of light insets (linear, spot, pendant). Power supply can be mounted remotely (PSE) or inside the profile (PSI).

Linijski sistem iz ekstrudiranega aluminjskega profila z vgrajeno 48 V tračnico. Možnost indirektno osvetlitve z opalnim difuzorjem vzdolž sistema. Širok nabor svetlobnih elementov (linearni, reflektorski, viseči). Napajalni modul je lahko montiran v sam profil (PSI) ali pa izven njega (PSE).

Linijski sistem od ekstrudiranog aluminjskog profila s integriranom 48 V tračnicom. Opcija - Indirektna komponenta sa SOP difuzorom. Široki raspon rasvjetnih komponenti za ugradnju u profil (linijski, spot, ovjesni). Napajanje se može ugraditi odvojeno (PE) ili ugradnjom unutar profila (PSI).

Spot insets

Atos LYN

Luminaire luminous flux: Up to 2x 458 - 555 lm
Beam angle: 26 mm (18°, 25°), 32 mm (20°, 30°, 50°), 45 mm (30°, 59°, 28-46°)
LED colour: 827, 830, 840, 927, 930, 935, 940
Spots: 1x / 2x
Driver: DALI
Diameter: 26, 32, 45 mm

Eye LYN

Luminaire luminous flux: Up to 1400 lm
Beam angle: 10°, 22°, 26°, 30°, 45°, 46°, 22 - 45°
LED colour: 927, 930, 935, 940
Driver: DALI
Diameter: 60 mm

Pendant insets

Biba LYN

Luminaire luminous flux: Up to 936 lm
Beam angle: 42°, 62°
LED colour: 830, 840, 927, 930, 935, 940
Driver: DALI
Diameter: 75 mm

Pipes 45 S LYN

Luminaire luminous flux: Up to 1300 lm
Beam angle: 42°, 62°
LED colour: 830, 840, 927, 930, 935, 940
Driver: DALI
Diameter: 45 mm

Pixy LYN

Luminaire luminous flux: Up to 1532 lm
Beam angle: 30°, 50°
LED colour: 830, 840, 927, 930, 935, 940
Driver: DALI

Zoe LYN

Luminaire luminous flux: Up to 1481 lm, 12W
LED colour: 830, 840, 927, 930, 935, 940
Driver: DALI

Linear insets

Kalis 36 LYN

Luminaire luminous flux: Up to 1600lm
Module length: 285 mm - 1405 mm
Optic: SOP, DPR
LED colour: 827, 830, 835, 840, 930, 940
Driver: DALI

Rylo LYN

Luminaire luminous flux: 60 - 130 lm/spot
Module length: 143 mm - 843 mm (4x - 24x spot)
Beam angle: 22°, 30°, 50°, Asymmetric
LED colour: 927, 930, 935, 940
Driver: DALI

Rylo LYN WW

Luminaire luminous flux: 995 - 1094 lm
Module length: 105 - 285 mm (4x, 8x, 12x spot)
LED colour: 927, 930, 940
Driver: DALI

Corner profiles

Vertical and horizontal corner

90° (both) and 135° (horizontal)
 Integrated PWR connection module
 Dimension: 50x50 mm

Power supply

PSE - power supply external

PWR supply position: Integrated in the ceiling cup
PWR supply type: 48V constant voltage driver

PSI - power supply internal

PWR supply position: Integrated in the profile inset
PWR supply type: 48V constant voltage driver



Trix

Uncompromising, no tricks

Number one in price performance

Slimmer, lower, and more convenient, but still has it all. Trix boasts minimalistic design, modularity, high efficiency, and resistance without giving up on its looks.

It is born for supermarkets, schools, offices and industrial plants. Long lines are really easy to install. Choose track spotlights when illuminating focus zones or linear optic for uniform illumination; the set of modules is really vast, for any occasion.

Številka ena, ko gre za razmerje med kakovostjo in ceno

Tanjši, nižji, ugodnejši, a še vedno ima vse. Trix odlikujeje minimalističen dizajn, modularnost, visoka učinkovitost in odpornost, ne da bi pri tem zaostajal v izgledu.

Narejen je za veleblagovnice, šole, pisarne in tovarne. Dolge linije je res enostavno namestiti. Izberite tračne reflektorje, ko želite usmeriti svetlobo, ali linearne optike za splošno osvetlitev. Nabor modulov je resnično širok, za vsako priložnost se najdejo.

Cjenovno na prvom mjestu

Tanji, niži i praktičniji, a ipak ima sve. Trix se može pohvaliti minimalističkim dizajnom, modularnošću, visokom učinkovitošću i otpornošću bez žrtvovanja atraktivnosti izgleda.

Kao stvoren je za supermarketete, škole, urede i industrijska postrojenja. Duge se linije vrlo lako ugrađuju. Za ujednačeno osvjetljavanje fokusnih zona odaberite reflektore ili linearnu optiku. Opširan set nudi module za svaku priliku.



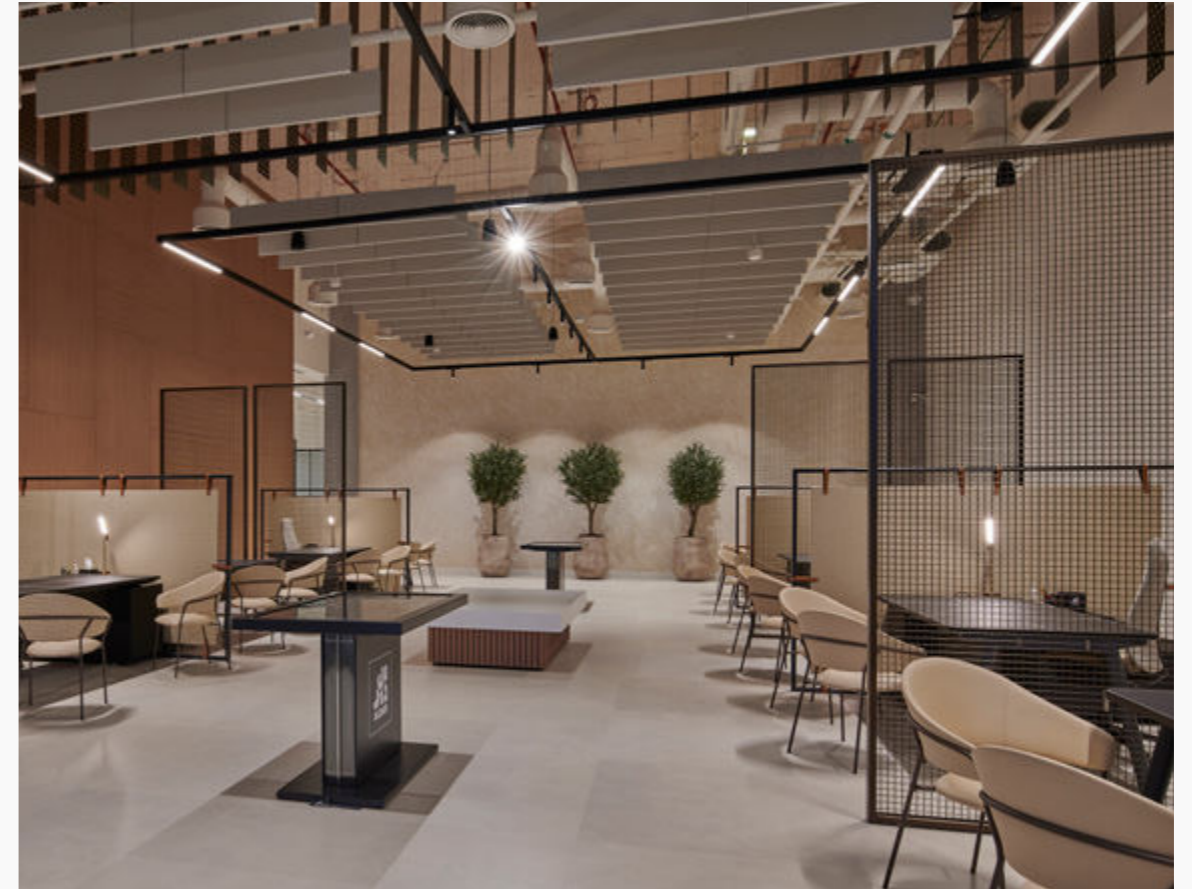

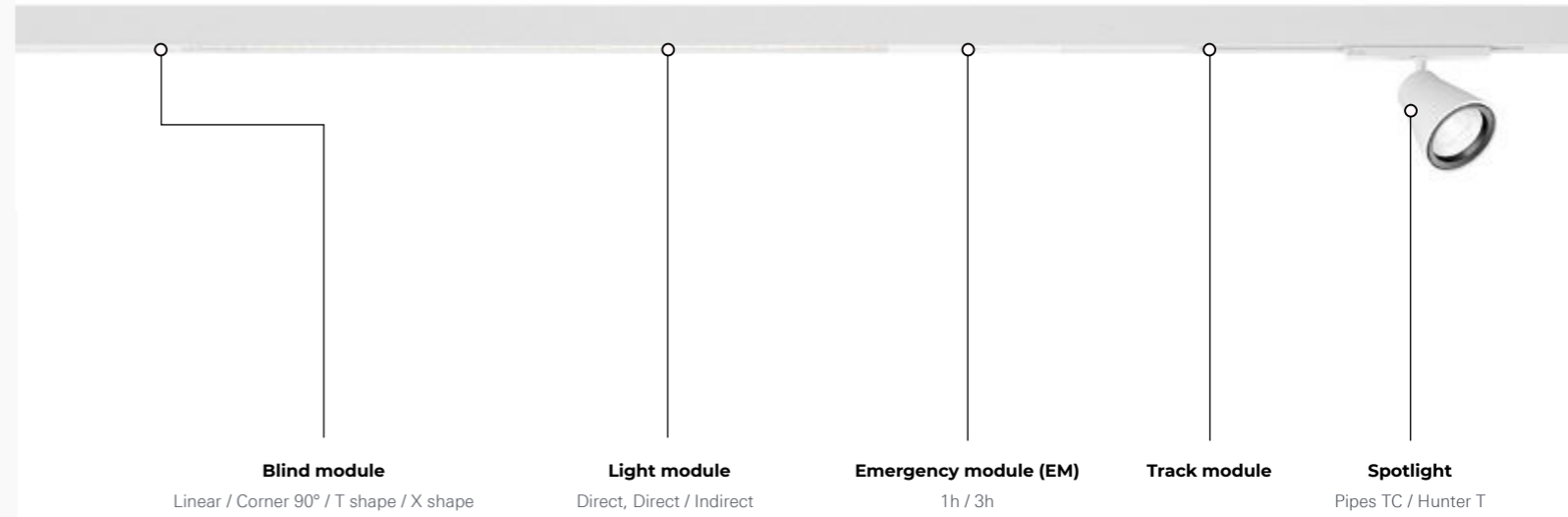

MAIN FEATURES



Light module

Supermarkets, classrooms, offices, or industrial plants have some specifics that have to be taken into consideration when planning lighting. Professional lenses allow you to choose the right light.

A lens for every need

- 60° UGR<19: low glare – for offices
- 110°: dispersed light – for spaces with low ceilings
- 30°: for spaces with high ceilings
- DAS: for shelves in supermarkets
- AS: for supermarkets, schools, hospitals

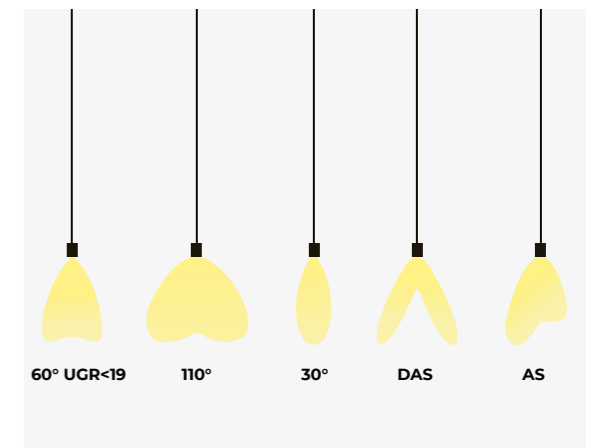

Track module for spots

Create contrasts, highlight textures, bring out the colours and make your product stand out. The track is integrated into the profile and combined with other modules.

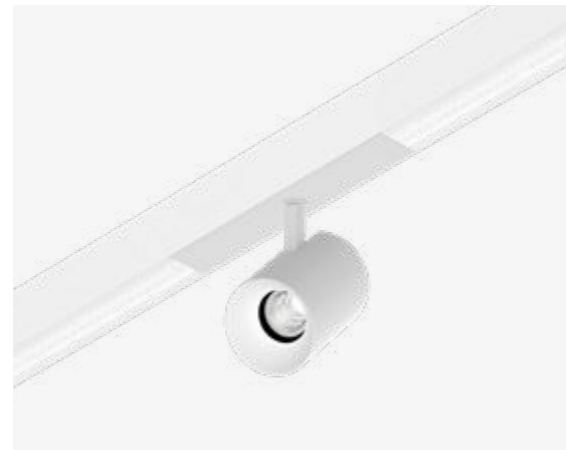

Light module and spotlight

Perfect for supermarkets when you want to combine the asymmetric light module and spot, to additionally point out the merchandise on shelves.

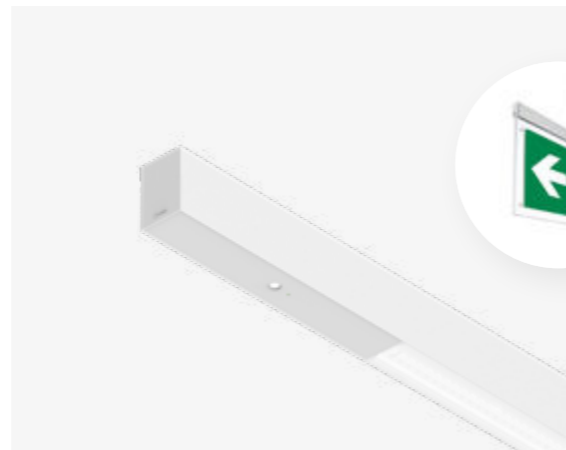

Emergency module

There are two types of emergency modules that can be integrated in the luminaire - spot or linear, with the autonomy of 1 or 3 hours.

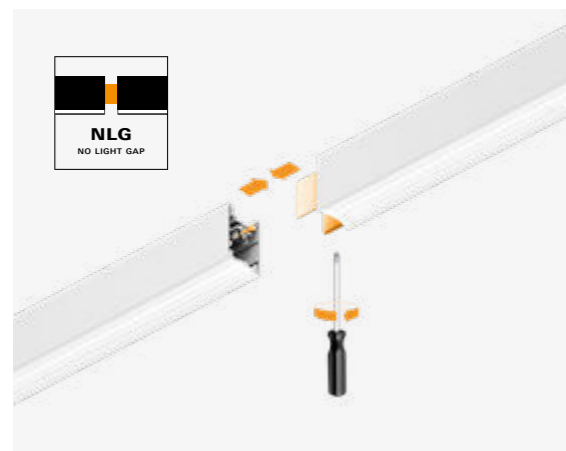

Perfect joints, no light gaps

With an innovative twist and lock joint element the assembly between two modules is now quick and easy and the profiles are strongly connected with no risk of bending. The light has absolutely no possibilities to escape.

Trix

Technical Overview

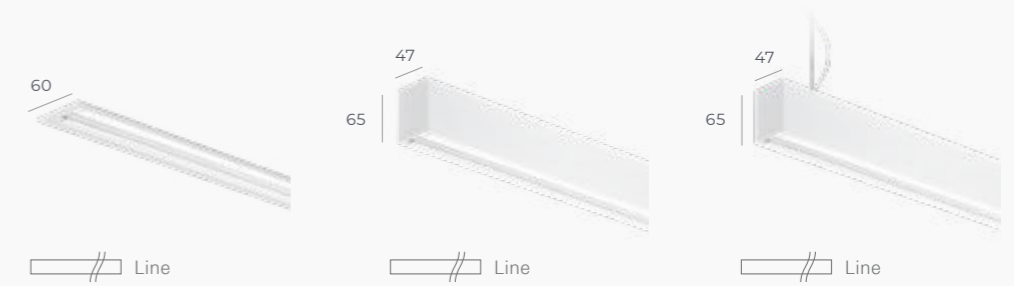

	RV Recessed visible trim	C/S Ceiling / Suspended	SDI Suspended Direct / Indirect
Glare control (UGR class)	UGR < 19 (60° optic, low output)	UGR < 19 (60° optic, low output)	UGR < 19 (60° optic, low output)
Luminaire luminous flux/m	1900 - 6200 lm/m	1900 - 6200 lm/m	3000 - 7800 lm/m
Light distribution	Direct	Direct	Direct / Indirect
DLOR/ULOR*	-	-	75 / 25%
Optics	30°, 60°, 60° (UGR<19), 110°, AS, ASD	30°, 60°, 60° (UGR<19), 110°, AS, ASD	30°, 60°, 60° (UGR<19), 110°, AS, ASD
LED colour	830, 840, 930, 940	830, 840, 930, 940	830, 840, 930, 940
Driver	Casambi, DALI, FO	Casambi, DALI, FO	Casambi, DALI, FO
Emergency kit**	EM spot 1h/3h with corridor/symmetric optic	EM spot 1h/3h with corridor/symmetric optic	EM spot 1h/3h with corridor/symmetric optic
Colour	1 2	1 2	1 2

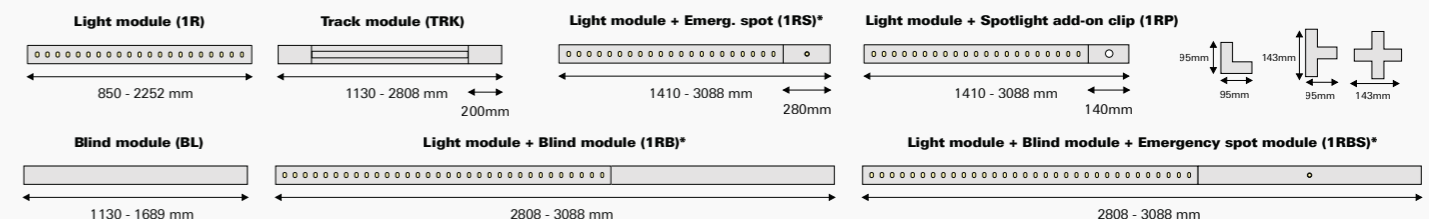

* EM and blind modul can be placed at the beginning or at the end of the line.

All technical data refer to light modules (1R). See web page for other module types. * Data refer to model L1690mm, 840 medium output, 60° lens. ** Available with 1RS and 1RBS module types. See web page for more info.



Light source: High-flux PCB LED modules, mid-power SMD LED, CRI>80/90, MacAdam≤2, 50.000h L80 B10 at 35°C. **Optic:** Highly efficient acrylic optical lenses. **Body:** Extruded aluminium profile, powder coated. **Ceiling cup:** For suspended versions, the ceiling cup and suspension set must be ordered separately. Find out more on the technical pages or online product configurator. **Control gear:** Integrated highly-efficient driver with fixed output (FO) or dimmable (DALI-TD, Casambi). Optional separate switching for direct / indirect versions. **Emergency:** EM Spot module with Corridor or Symmetric optic, 1h or 3h autonomy. **Power supply:** 230V 50Hz.

Svetlobni vir: PCB LED moduli visoke svetilnosti, z SMD LED, CRI>80, barvno odstopanje MacAdam≤2, 50.000 h L80 B10 na 35 °C. **Optika:** Visoko učinkovite optične leče iz akrila. **Ohišje:** Ekstrudiran profil iz aluminija, prašno barvan. **Stropna rozeta:** Za viseče verzije se rozete in vešala naročajo posebej. Več na straneh s tehnično vsebino ali v spletnem konfiguratorju. **Napajalnik:** Integriran visoko učinkoviti LED konverter s konstantnim tokom (FO) ali regulacijskim izhodom (DALI-TD, Casambi). Opcijsko ločeno prižiganje direktne / indirektno komponente. **Varnostni modul:** Varnostni modul z 1 ali 3 urami avtonomije z optikama za simetrično in eliptično osvetlitev. **Napajanje:** 230 V 50 Hz.

Izvor svetla: PCB LED moduli velikog svetlosnog toka, SMD LED srednje snage, CRI>80, MacAdam≤2, 50.000 h L80 B10 na 35°C. **Optika:** Visokoeфикаsne akrilne leče. **Kućište:** Ekstrudirani aluminijски profil, elektrostatski plastificiran. **Stropna rozeta:** Za ovesjne inačice, stropna rozeta i ovesjni pribor moraju biti naručeni zasebno. Otkrij više na tehničkim stranicama ili online konfiguratoru proizvoda. **Predspojne naprave:** Integrirana visoko efikasna predspojna naprava konstantnog izlaza (FO) ili dimabilna (DALI-TD, Casambi). Odvojeno paljenje direktne/indirektno komponente na zahtjev. **Režim nužne rasvjete:** EM Spot modul sa simetričnom optikom ili optikom za hodnike, autonomije 1h ili 3 h **Napajanje:** 230 V 50 Hz.

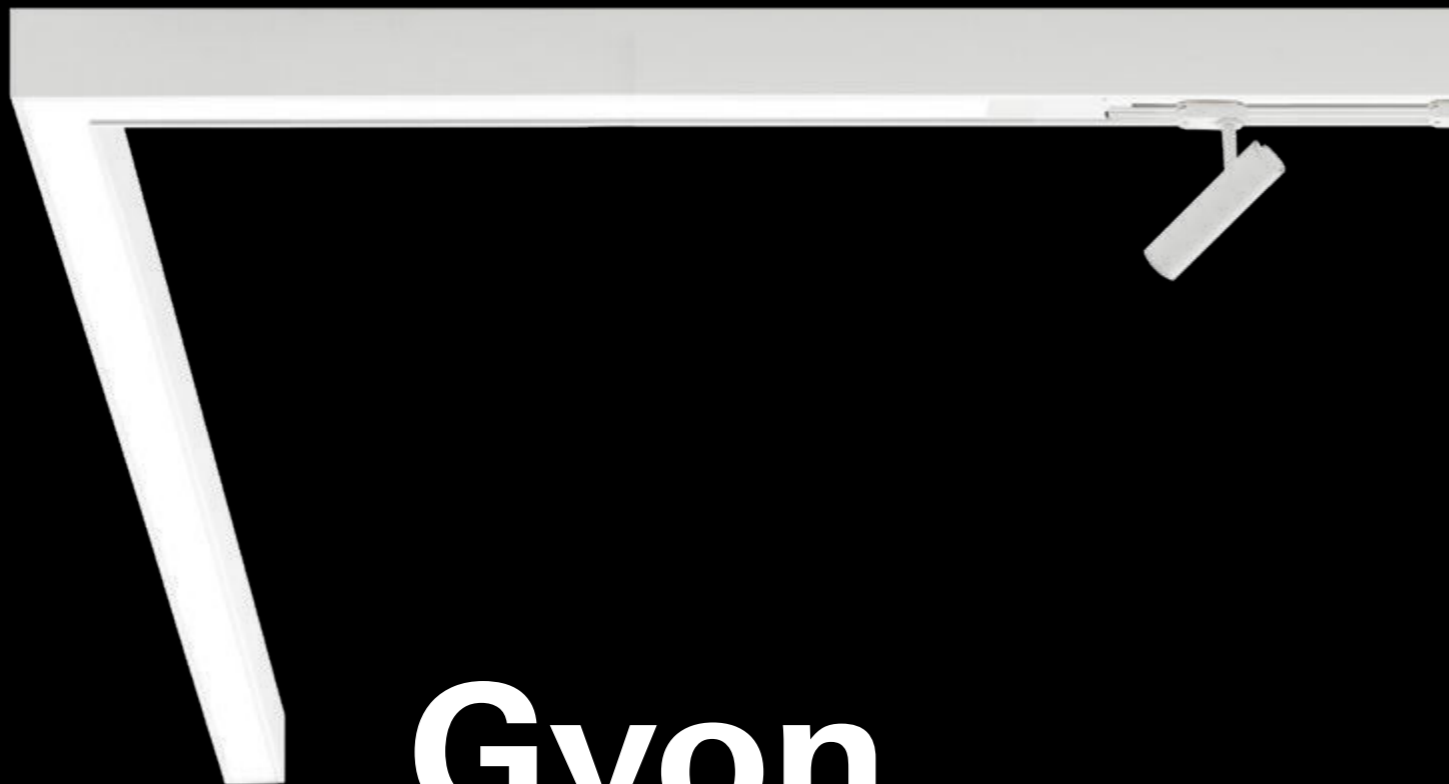

Gyon

More is more

Fully flexible, widely adaptable, all efficient

The possibility of endless lines allows you to go as far as you want. Thanks to the modularity, the luminaire can be designed, as you want it and to go in different directions. This is only the beginning of what you can create with Gyon.

Outstanding performance plus bespoke lengths is the perfect recipe for your modular solution, to find the best possible fit and excellent end result. The way you combine the light lines is up to you, as it should be.

Popolnoma prilagodljiv, široko uporaben, povsem učinkovit

Možnost neskončnih linij dovoljuje, da greste tako daleč, kot želite. Zaradi modularnosti lahko to svetilo poljubno umeščate v prostor in ob tem spreminjate smer. To pa je šele začetek tega, kar lahko ustvarite s svetilom Gyon.

Vrhunska kakovost in dolžine po meri so najboljši recept za vaše modularne rešitve, ki potrebujejo izvrstno prileganje prostoru in odlični končni rezultat. Način, kako boste kombinirali svetlobne linije, pa je prepuščen vam, kot je edino prav.

Sasvim fleksibilan, široko primjenjiv, potpuno učinkovit

Mogućnost beskrajinah linija daje bezbrojne mogućnosti. Zahvaljujući modularnosti, rasvjeta može biti dizajnirana na bilo koji način i ići u različitim smjerovima. To je samo početak onoga što se može stvoriti uz Gyon.

Izvršne performanse uz navedene domete savršen su recept za modularno rješenje, kako bi postigli najbolju kompoziciju i odlični krajnji rezultat. Način kombiniranja svjetlosnih linija ovisi o vlastitim željama, kako to i treba biti.





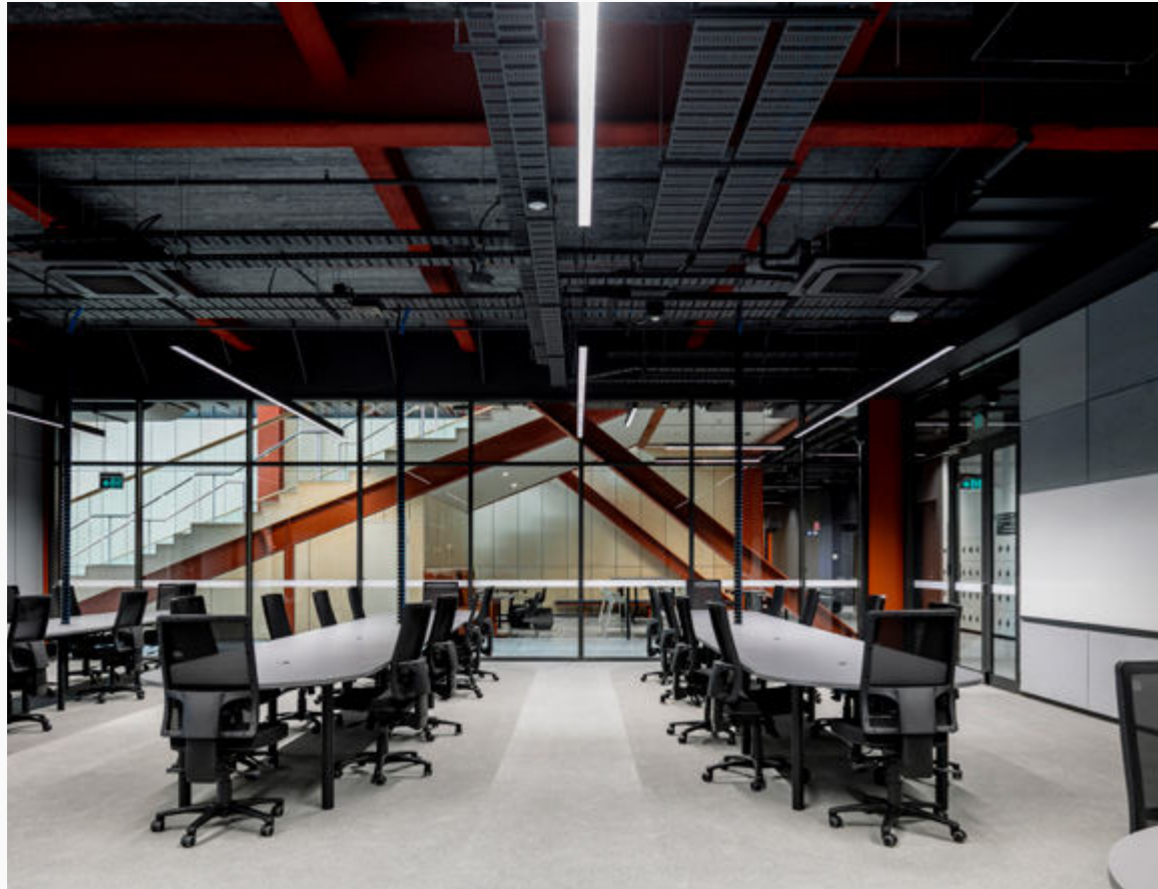





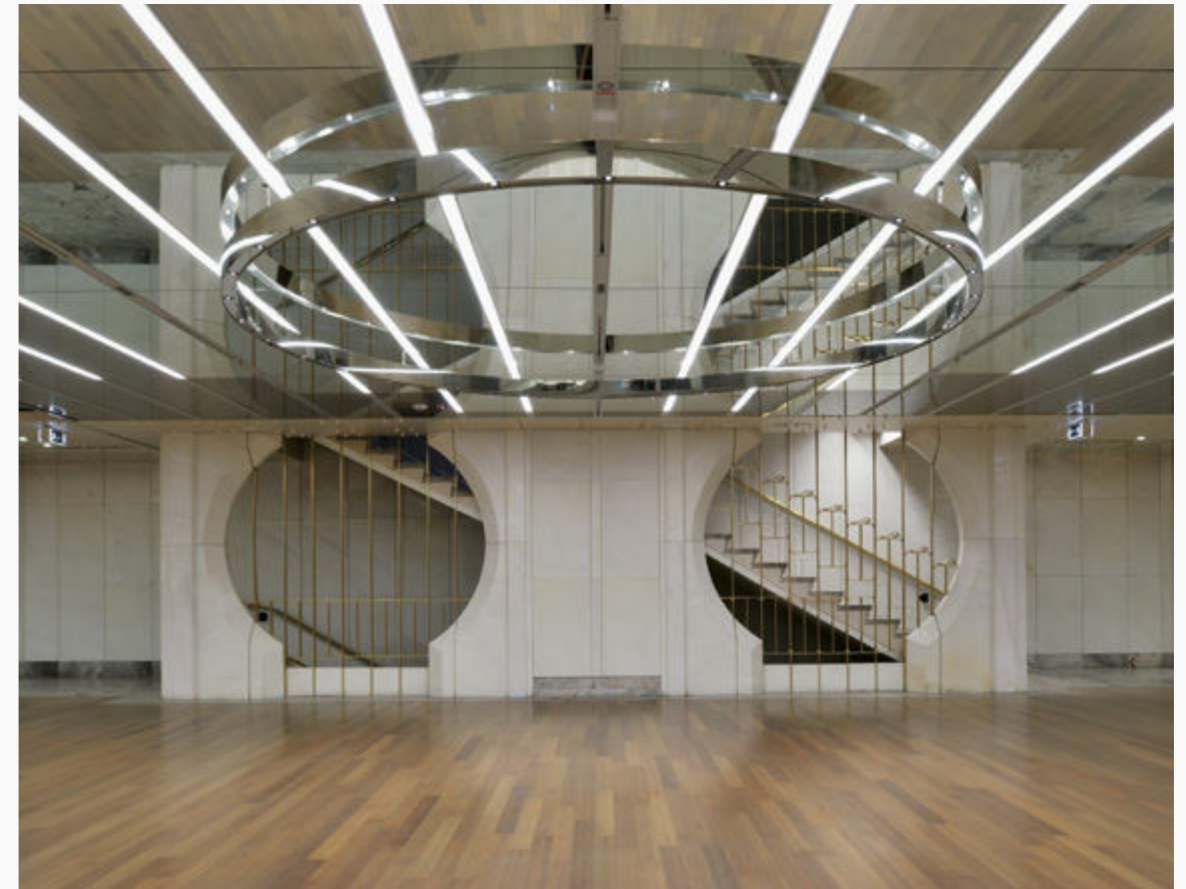





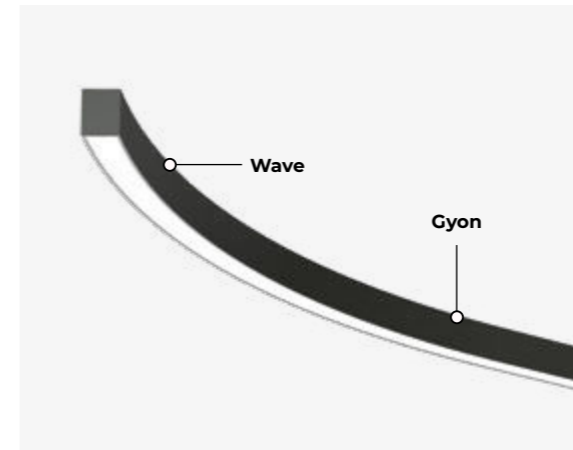
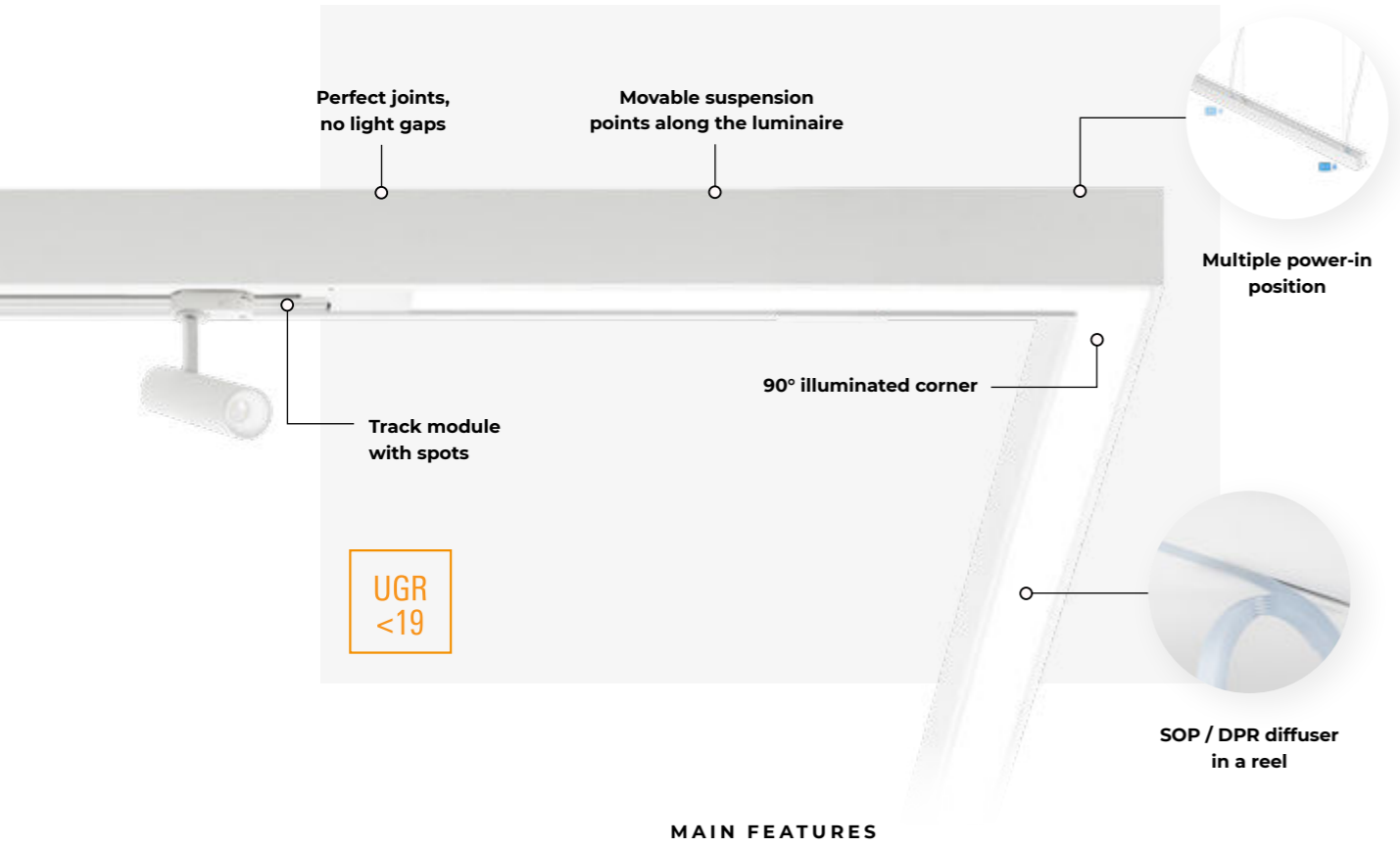

Wave + Gyon = a perfect couple

There is an endless modularity that gives you the possibility to adapt the luminaire to your needs. You can combine curved modules of Wave and the linear modules of Gyon to create unique flexible lines.

Perfect joints, no light gaps

With an innovative twist and lock joint element, the assembly between two modules is now quick and easy, and the profiles are strongly connected with no risk of bending. The light has absolutely no possibilities to escape.

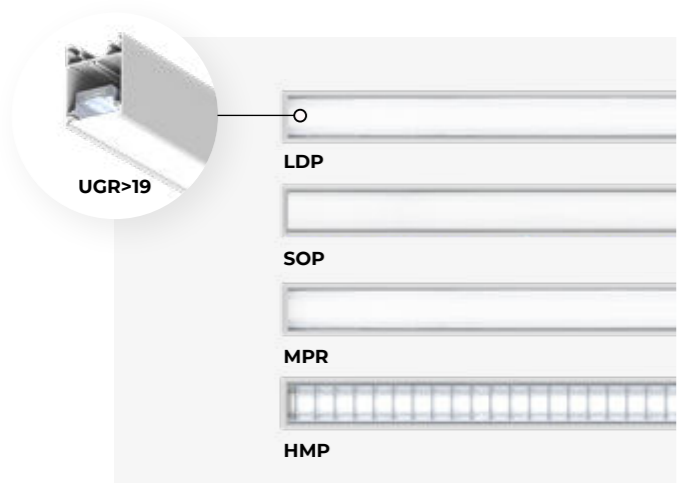
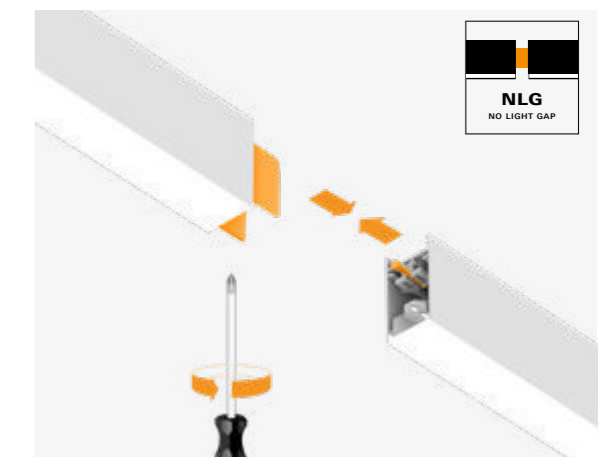

A wide variety of optics

- Gyon family offers maximum optics selection:
- Low glare diffused prism with UGR>19 (LDP)
 - Satin opal polycarbonate diffuser (SOP)
 - Micro-prismatic polycarbonate optic (MPR)
 - Satin silver coated aluminium louvre (HMP)
 - Asymmetric optic (AS)

LDP optic is perfect for workplaces

Inappropriate lighting causes headaches and eye trouble. Create a healthier working environment with lighting which affects our well-being, mood and concentration.



Movable suspension points

The suspension can be moved along the luminaire to ensure optimal mounting on your ceiling.

Gyon S IP54

IP54 protection allows you to use Gyon beneath a roof overhang. It is resistant to dust and moisture.



Gyon

Technical Overview

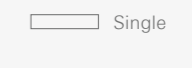
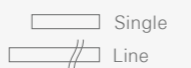
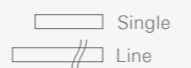
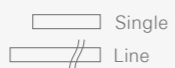
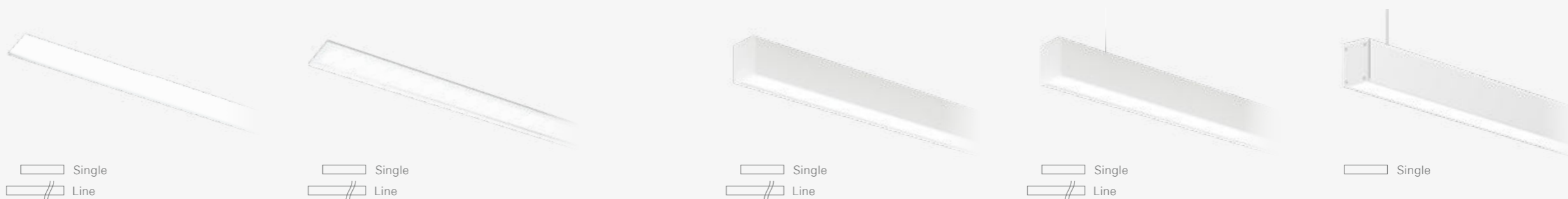

	RI Recessed trim-less	RV Recessed visible trim	C/S Ceiling / Suspended	SDI Suspended Direct / Indirect	S IP54 Suspended with IP54
Glare control (UGR class)	UGR < 19 (LDP optic)	UGR < 19 (LDP optic)	UGR < 19 (HMP, LDP optic)	UGR < 19 (HMP, LDP optic)	-
Luminaire luminous flux/m	980 - 2900 lm/m	800 - 2900 lm/m	800 - 2900 lm/m	1450 - 5200 lm/m	1050 - 2750 lm/m
Light distribution	Direct	Direct	Direct	Direct / Indirect	Direct
Optics	SOP, DPR, LDP (UGR<19)	SOP, DPR, HMP, LDP (UGR<19), AS	SOP, DPR, HMP, LDP (UGR<19), AS	SOP, DPR, HMP, LDP (UGR<19), AS	SOP
LED colour	827, 830, 835, 840, 930, 940	827, 830, 835, 840, 930, 940	827, 830, 835, 840, 930, 940	827, 830, 835, 840, 930, 940	827, 830, 835, 840, 930, 940
Dynamic illumination	Tunable white 2700 - 6500K	Tunable white 2700 - 6500K	Tunable white 2700 - 6500K	Tunable white 2700 - 6500K	Tunable white 2700 - 6500K
Driver	Casambi, DALI, FO	Casambi, DALI, FO	Casambi, DALI, FO	Casambi, DALI, FO, TD	DALI, FO
Emergency kit	EM 1h / 3h	EM 1h / 3h	EM 1h / 3h	EM 1h / 3h	-
IP protection	IP20 / IP44**	IP20 / IP44**	IP43 / IP20***	IP20	IP54
Colour	1	1 2	1 2 3 6 9 +	1 2 3 6 9 +	1 2

Dimensions	RI	RV	C/S	SDI	S IP54
	L (mm): 565 - 3092	L (mm): 592 - 3122	L (mm): 576 - 3112	L (mm): 842 - 3112 SH (mm): 1500, 3000, 5000	L (mm): 581 - 3101 SH (mm): 1500, 3000, 5000

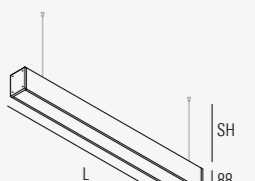
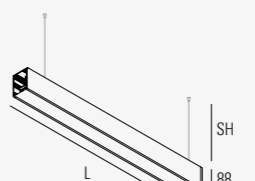
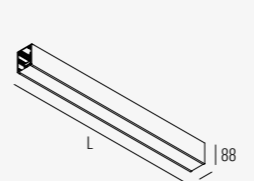
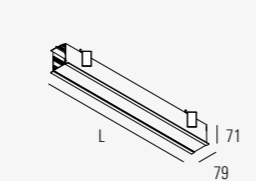
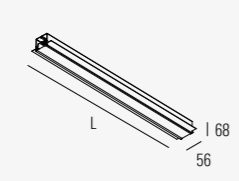

* Data refer to model L1405mm, 840 medium output, SOP diffuser. ** IP value from the exposed side for single version. *** IP value for suspended mounting and lines.

Design the system with **intraConstructorPRO** $\geq 90\%$ **GRO** **CASAMBI** **WARRANTY**

Light source: High-flux PCB LED modules, mid-power SMD LED, CRI>80/90, MacAdam ≤ 2 , 50.000h L90 B10 at 35°C. **Optic:** Satin opal diffuser (SOP) or soft-light prismatic optics (DPR) from polycarbonate for direct light. Satin opal polycarbonate diffuser (SOP) for indirect light, Satin silver-coated aluminium double parabolic louvre (HMP), Low glare diffused prismatic optic (LDP) with UGR<19, Linear asymmetrical optic with opal polycarbonate diffuser. **Body:** Extruded aluminium profile, powder coated. **Ceiling cup:** For suspended versions, the ceiling cup and suspension set must be ordered separately. Find out more on the technical pages or online product configurator. **Control gear:** Integrated highly-efficient driver with fixed output (FO) or dimmable (DALI-TD, Casambi). Optional separate switching for direct / indirect versions. **Emergency:** Emergency kit version with autonomy 1h or 3h. **Power supply:** 230V 50Hz.

Svetlobni vir: PCB LED moduli visoke svetilnosti, z SMD LED, CRI>80/90, barvno odstopanje MacAdam ≤ 2 , 50.000 h L90 B10 na 35 °C. **Optika:** Satinirani opalni polikarbonatni difuzor (SOP) ali mikro-prizmatična difuzna PMMA optika (DPR) za direktno osvetlitev in opalni polikarbonatni difuzor (SOP) za indirektno osvetlitev, Dvojna parabolična optika iz visoko odsevnega satiniranega posebnega aluminija (HMP), Mikro-prizmatična difuzna PMMA optika (LDP) z omejenim bleščanjem UGR<19, Linearna asimetrična optika z opalnim polikarbonatnim difuzorjem. **Ohišje:** Ekstrudiran profil iz aluminija, prašno barvan. **Stropna rozeta:** Za viseče verzije se rozete in vešala naročajo posebej. Več na straneh s tehnično vsebino ali v spletnem konfiguratorju. **Napajalnik:** Integriran visoko učinkoviti LED konverter s konstantnim tokom (FO) ali regulacijskim izhodom (DALI-TD, Casambi). Opcijsko ločeno prižiganje direktne / indirektno komponente. **Varnostni modul:** Varnostni modul z 1 ali 3 urami avtonomije. **Napajanje:** 230 V 50 Hz.

Izvor svetla: PCB LED moduli velikog svetlosnog toka, SMD LED srednje snage, CRI>80/90, MacAdam ≤ 2 , 50.000 h L90 B10 na 35 °C. **Optika:** Satinirani opalni difuzor (SOP) ili polikarbonatna prizmatična optika (DPR) za direktnu komponentu. Satinirani opalni polikarbonatni difuzor (SOP) za indirektnu komponentu, Dvostruko parabolični raster od satiniranog aluminija parenog srebrom (HMP), Difuzna prizmatična optika ograničenog bliještanja (LDP) s UGR<19, Linijska asimetrična optika s polikarbonatnim difuzorom. **Kućište:** Ekstrudirani aluminijški profil, elektrostatski plastificiran. **Stropna rozeta:** Za ovjesne inačice, stropna rozeta i ovjesni pribor moraju biti naručeni zasebno. Otkrij više na tehničkim stranicama ili online konfiguratoru proizvođača. **Predspojne naprave:** Integrirana visoko efikasna predspojna naprava konstantnog izlaza (FO) ili dimabilna (DALI-TD, Casambi). Odvojeno paljenje direktne/indirektno komponente na zahtjev. **Režim nužne rasvjete:** Modul nužne rasvjete autonomije 1 ili 3 h. **Napajanje:** 230 V 50 Hz.



BIGSEE
PRODUCT DESIGN
AWARD
2018



Wave

Bored of being straight

If straight is not your thing, you're on the right page

From classical form to an artistic drawing with irregular lines and round objects, Wave gives you the privilege of doing it as big and as bold as you want. Use a quarter or an eighth of a circle and combine it with the straight lines of Gyon, creating something that's completely unique and fits your needs. Wave is the perfect pick for big fluid spaces as it can easily chase the architecture and gives your visitors a reason to look up.

Če ste se naveličali ravnih linij, je tole za vas

Poigrajte se s sestavljanjem nepravilnih oblik in uživajte v svobodi ustvarjanja. Wave je svetilo, ki vam pušča toliko svobode, kot je potrebujete, saj vam omogoča veliko fleksibilnosti pri sestavi in kombinaciji vijugastih in ravnih linij. Wave je prava izbira za velike fluidne prostore, v katerih lahko sledi arhitekturi in s svojo edinstvenostjo obiskovalcem dvigne pogled.

Ako su vam dosadile ravne crte, ovo je za vas

Od klasičnog oblika do umjetničkog crteža s nepravilnim linijama i okruglim objektima, Wave vam daje privilegiju da to učinite onoliko veliko i odvažno koliko želite. Koristite četvrtinu ili osminu kruga i kombinirajte je s ravnim linijama Gyona, stvarajući nešto što je posve jedinstveno i odgovara vašim potrebama. Wave je savršen odabir za velike fluidne prostore, jer može jednostavno slijediti arhitekturu i dati posjetiteljima razlog da pogledaju gore.







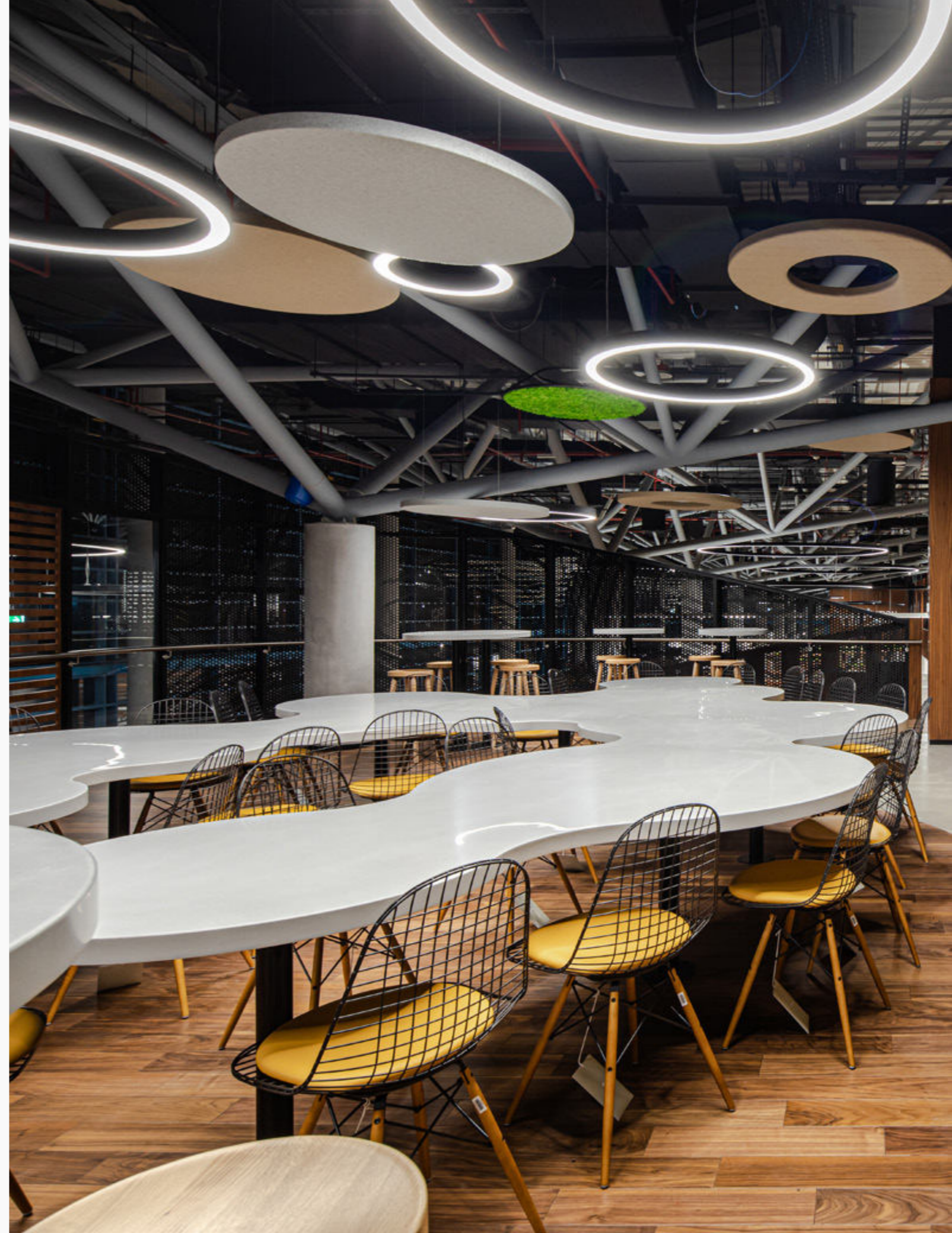



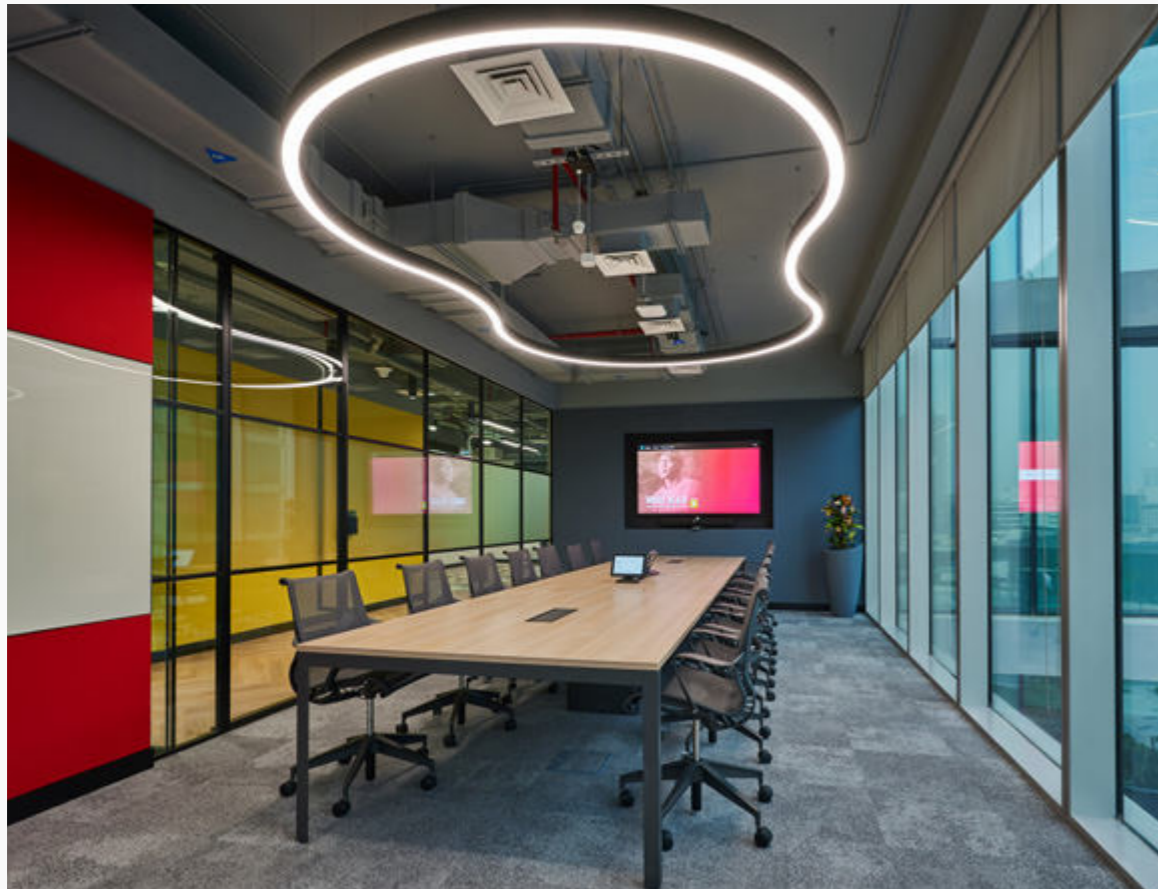



MAIN FEATURES

Direct and indirect illumination can be controlled separately



Different spaces, different sizes

Wave Round is available in different sizes. Those with smaller diameters are made from one piece, while the bigger ones are composed of multiple parts and can therefore easily embrace pillars or staircases.

Wave + Gyon = a perfect couple

There is an endless modularity that gives you the possibility to adapt the luminaire to your needs. You can combine curved modules of Wave and the linear modules of Gyon to create unique flexible lines.

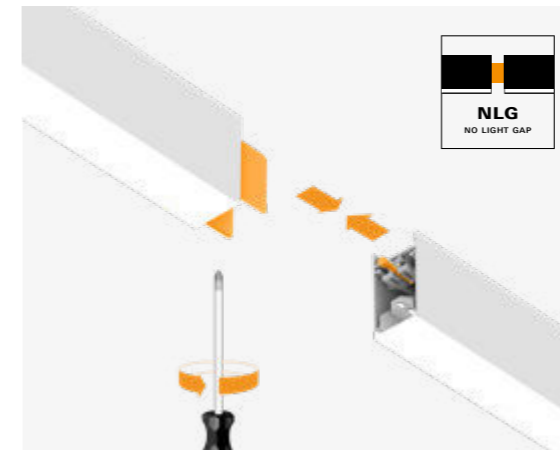
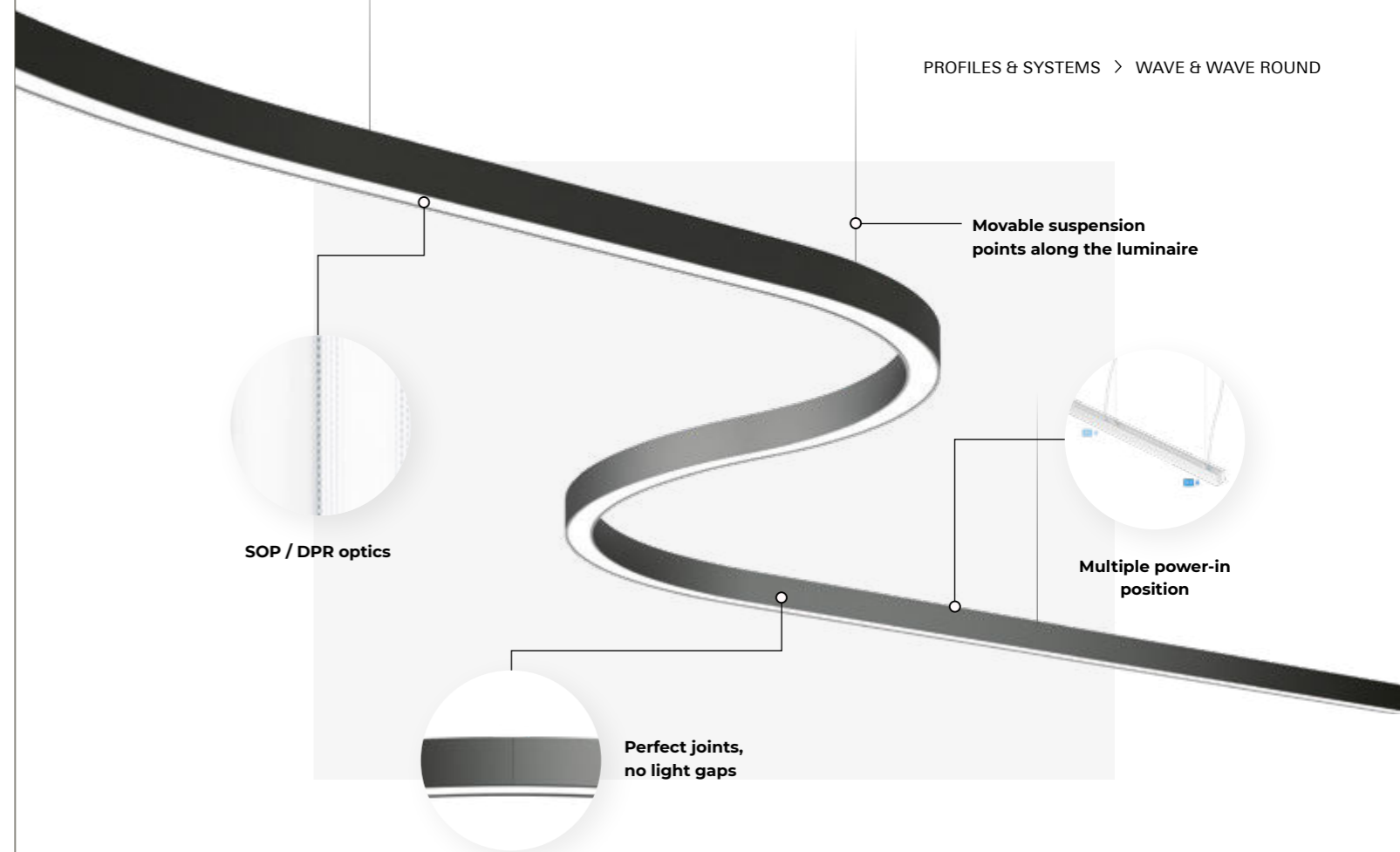
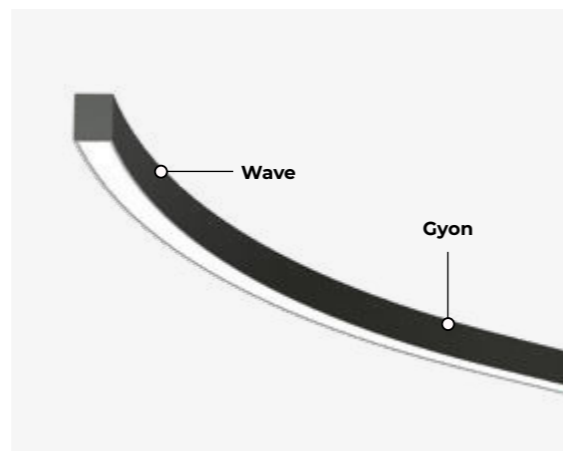

Perfect joints, no light gaps

With an innovative twist and lock joint element, the assembly between two modules is now quick and easy, and the profiles are strongly connected with no risk of bending. The light has absolutely no possibilities to escape.

Movable suspension points

The suspension can be moved along the luminaire to ensure optimal mounting on your ceiling. Only one suspension per joint is needed instead of two. In case of indirect illumination movement is limited.



Wave

Technical Overview



WAVE ROUND C/S

Ceiling / Suspended

Luminaire luminous flux	1700 - 65700 lm	WAVE ROUND SDI	3400 - 132300 lm
Light distribution	Direct	Suspended Direct / Indirect	Direct / Indirect
DLOR/ULOR*	-		52 / 48%
Optics	SOP, DPR		SOP, DPR
LED colour	827, 830, 835, 840, 930, 940		827, 830, 835, 840, 930, 940
Dynamic illumination	Tunable white 2700 - 6500K		Tunable white 2700 - 6500K
Driver	Casambi, DALI, FO		Casambi, DALI, FO
Dimensions	D (mm): 615 - 8000		D (mm): 615 - 8000 SH (mm): 1500, 3000, 5000

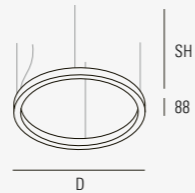
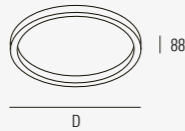

* Data refer to LED colour 840, medium output, SOP diffuser.

Standard: **1** **2** **3** **6** **9** Special colours:



Light source: High-flux PCB LED modules, mid-power SMD LED, CRI>80/90, MacAdam \leq 2, 50.000h L90 B10 at 35°C. **Optic:** Satin opal diffuser (SOP) or soft-light prismatic optics (DPR) from polycarbonate for direct light. Satin opal polycarbonate diffuser (SOP) for indirect light. **Body:** Extruded aluminium profile, powder coated. **Ceiling cup:** For suspended versions, the ceiling cup and suspension set must be ordered separately. Find out more on the technical pages or online product configurator. **Control gear:** Integrated highly-efficient driver with fixed output (FO) or dimmable (DALI-TD, Casambi). Optional separate switching for direct / indirect versions. **Power supply:** 230V 50Hz.

Svetlobni vir: PCB LED moduli visoke svetilnosti, z SMD LED, CRI>80/90, barvno odstopanje MacAdam \leq 2, 50.000 h L90 B10 na 35 °C. **Optika:** Satinirani opalni polikarbonatni difuzor (SOP) ali mikro-prizmatična difuzna PMMA optika (DPR) za direktno osvetlitev in opalni polikarbonatni difuzor (SOP) za indirektno osvetlitev. **Ohišje:** Ekstrudiran profil iz aluminija, prašno barvan. **Stropna rozeta:** Za viseče verzije se rozete in vešala naročajo posebej. Več na straneh s tehnično vsebino ali v spletnem konfiguratorju. **Napajalnik:** Integriran visoko učinkoviti LED konverter s konstantnim tokom (FO) ali regulacijskim izhodom (DALI-TD, Casambi). Opcijsko ločeno prižiganje direktne/indirektne komponente. **Napajanje:** 230 V 50 Hz.

Izvor svetla: PCB LED moduli velikog svetlosnog toka, SMD LED srednje snage, CRI>80/90, MacAdam \leq 2, 50.000 h L90 B10 na 35 °C. **Optika:** Satinirani opalni difuzor (SOP) ili polikarbonatna prizmatična optika (DPR) za direktnu komponentu. Satinirani opalni polikarbonatni difuzor (SOP) za indirektnu komponentu. **Kućište:** Ekstrudirani aluminij-ski profil, elektrostatski plastificiran. **Stropna rozeta:** Za ovesjne inačice, stropna rozeta i ovesjni pribor moraju biti naručeni zasebno. Otkrij više na tehničkim stranicama ili online konfiguratoru proizvođača. **Predspojne naprave:** Integrirana visoko efikasna predspojna naprava konstantnog izlaza (FO) ili dimabilna (DALI-TD, Casambi). Odvojeno paljenje direktne/indirektne komponente na zahtjev. **Napajanje:** 230 V 50 Hz.

LINEAR

See more in Gyon Family (page 235)

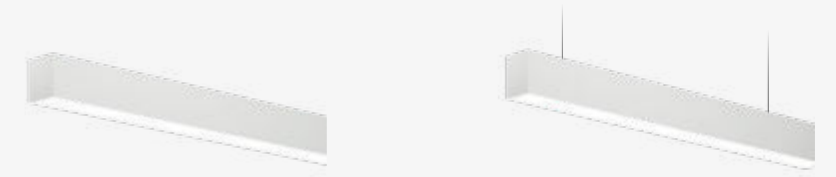

CURVED 45°

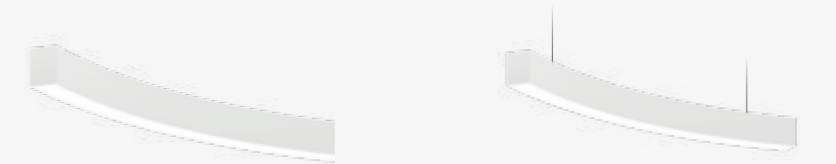

CURVED 90°



WAVE C/S

Ceiling / Suspended

Luminaire luminous flux	1950 - 5300 lm/m	WAVE SDI	3800 - 10700 lm/m
Light distribution	Direct	Suspended Direct / Indirect	Direct / Indirect
DLOR/ULOR*	-		52 / 48%
Optics	SOP, DPR		SOP, DPR
LED colour	827, 830, 835, 840, 930, 940		827, 830, 835, 840, 930, 940
Dynamic illumination	Tunable white 2700 - 6500K		Tunable white 2700 - 6500K
Driver	Casambi, DALI, FO		Casambi, DALI, FO

Dimensions

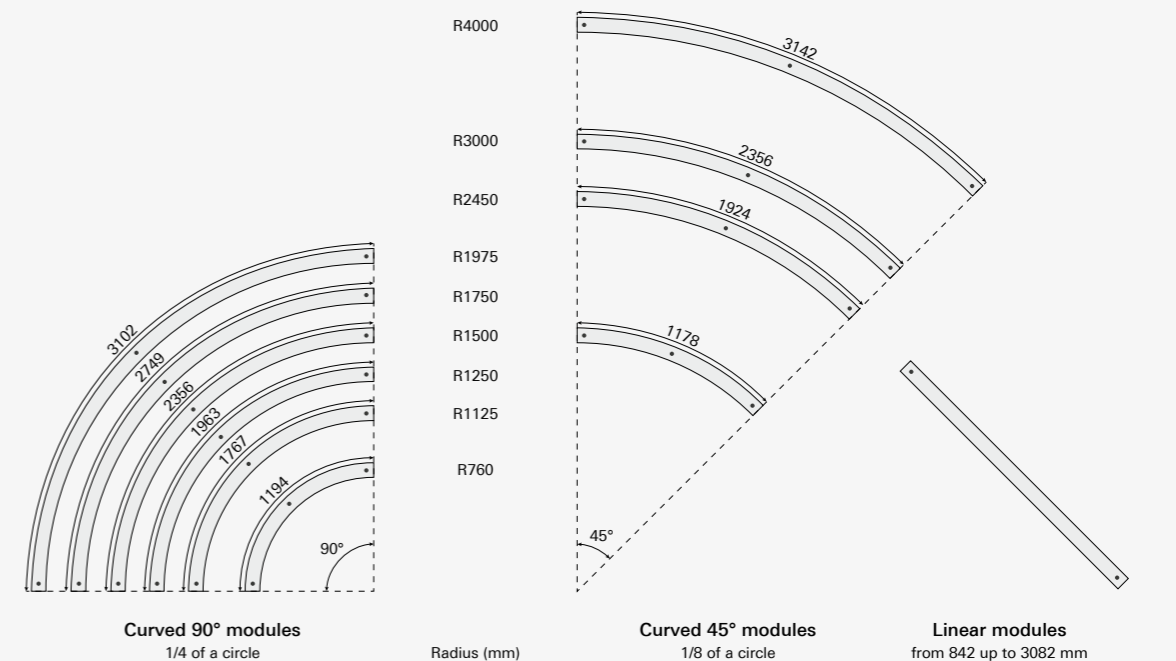
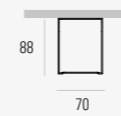



Acousto

Acoustic comfort

Keeps noise down

In an open workspace, there is nothing more annoying than noises you don't want to hear. But here comes Acousto and it's here to make a change. Acousto is a luminaire that features acoustic panels that provide excellent absorption of sounds, making your area not only quieter, but also more private.

Think about Acousto when creating large and open spaces with a majority of hard surfaces and an echo, or when you're simply seeking a different and green solution. And by saying that, we're thinking about MOSSwall® panels, that not only help absorb the noise but also bring nature indoors and are maintenance free. How cool is that?

Znižuje hrup

Največji problem odprtih prostorov so slaba akustika in zvoki, ki jih ne želite slišati. S tem v mislih smo razvili svetilo Acousto z akustičnimi paneli, ki z ravno pravšnjo absorpcijo zvoka v vaš delovni kotiček vnaša tišino in zasebnost.

Acousto je popolna rešitev za hrupne odprte prostore, ki poleg vsega potrebujejo še drugačno in okolju prijazno rešitev, saj lahko svoj Acousto naročite tudi s posebnim mahom, ki bo v vaš prostor vnesel naravno zelenje.

Smanjuje buko

U otvorenom radnom prostoru nema ništa neugodnije od zvukova koje ne želite čuti. Ali u pomoć dolazi Acousto kako bi promijenio stvari. Acousto je rasvjetno tijelo s akustičnim panelima koji pružaju izvrsno upijanje zvukova, čineći vaš prostor ne samo tišim, već i privatnijim.

Sjetite se Acousta pri stvaranju velikih i otvorenih prostora s većinom tvrdih površina i jekom, ili kada jednostavno tražite drugačije i zeleno rješenje. Pod time mislimo na MOSSwall® panele, koji ne samo da pomažu pri upijanju buke, već donose prirodu u zatvoreni prostor i ne moraju se održavati. Nije li to super?



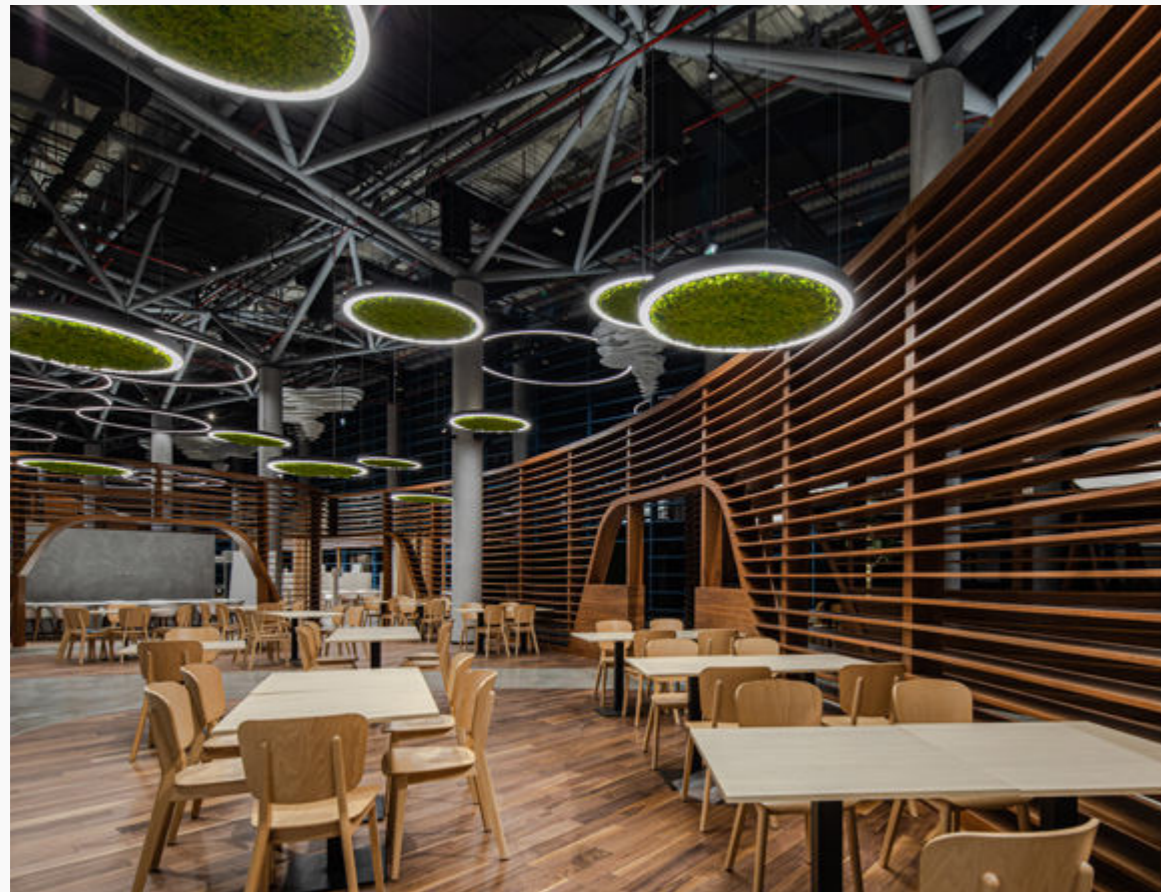



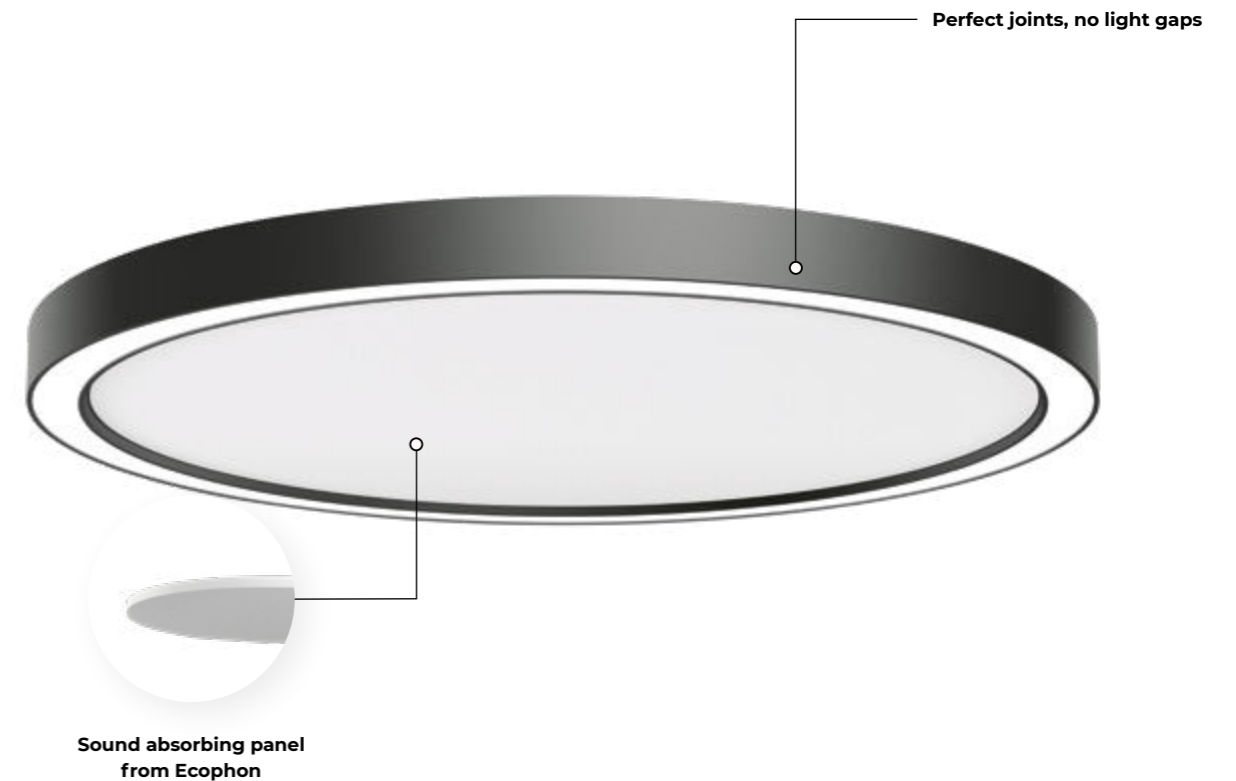
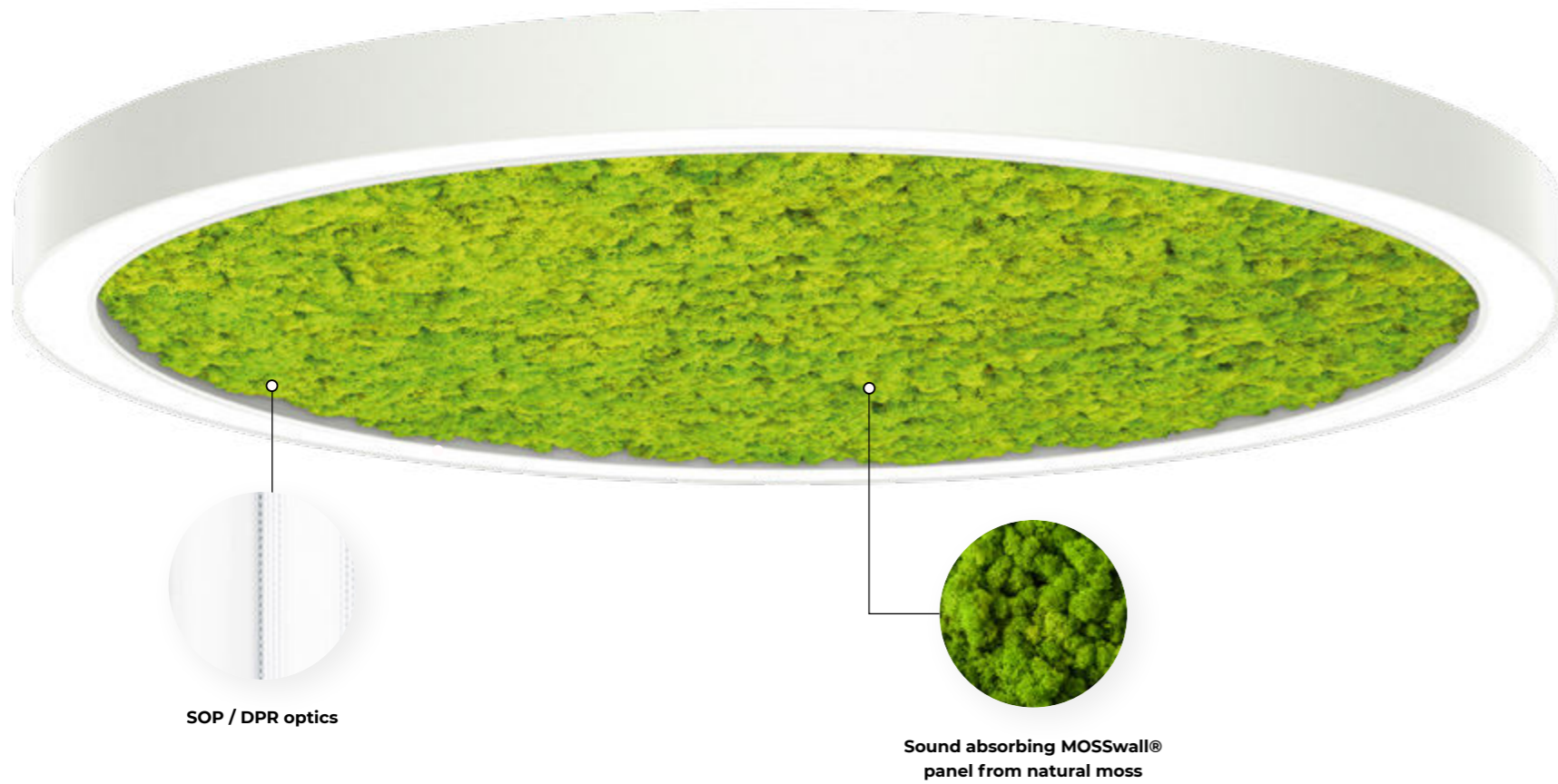

Wasabi Mint Natural

Anti - static Non - flammable Sound absorbing

A glimpse of nature

MOSSwall® is produced from a natural lichen by using a 100% ecological application. It requires a 40 - 50% relative humidity level and does not appreciate direct sunlight. If the humidity drops below 40%, the lichens crystallize and dries, signalling the atmospheric change. It's 100 % maintenance-free and certified as fire-resistant. MOSSwall® panel has a 3-year warranty.

Your open office luminaire

Think about Acousto when planning an open office with lots of high frequency noises, like phone ringing.

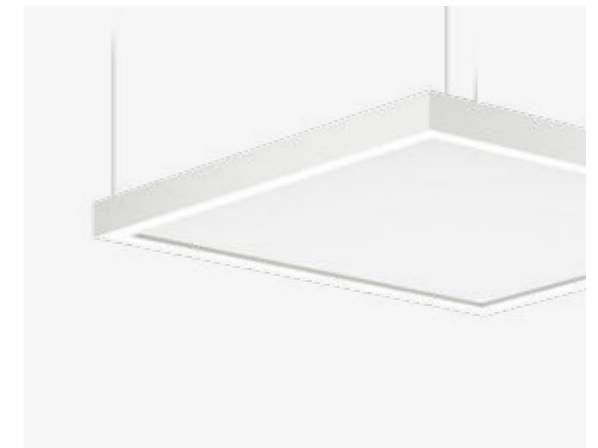

Great sound absorption

Acousto features A-class sound absorption. Measurements show that MOSSwall® absorbs lower frequencies better, while Ecophon™ has better performance with speech frequencies.

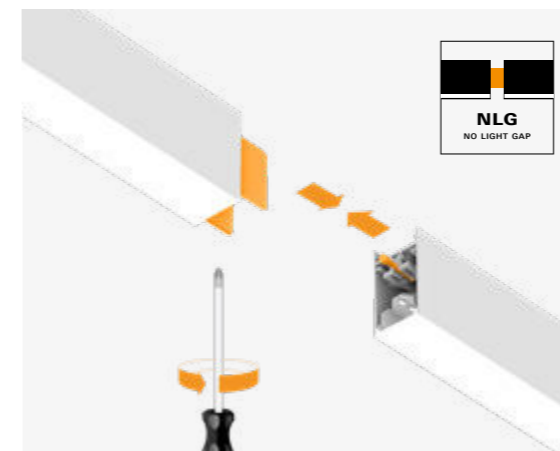
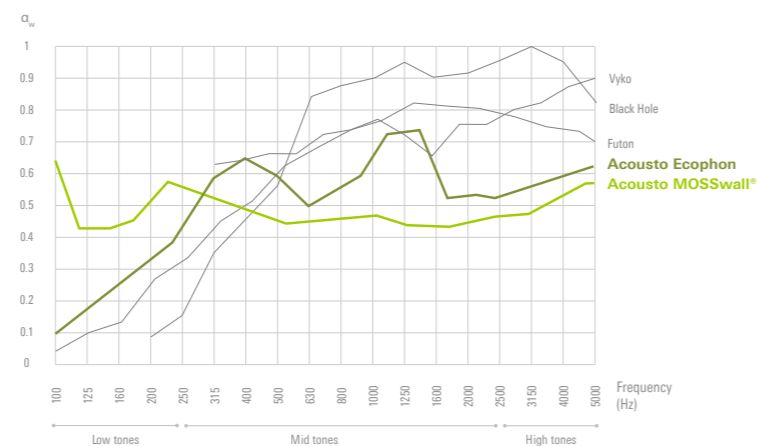
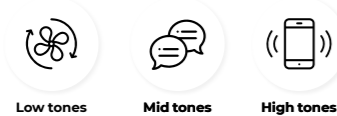

Perfect joints, no light gaps

With an innovative twist and lock joint element, the assembly between two modules is now quick and easy, and the profiles are strongly connected with no risk of bending. The light has absolutely no possibilities to escape.

Acousto

Technical Overview



MOSSWALL®



ECOPHON



	ROUND C/S Ceiling / Suspended	ROUND SDI Suspended Direct / Indirect	SQUARE C/S Ceiling / Suspended	SQUARE SDI Suspended Direct / Indirect	RECTANGULAR C/S, SDI Ceiling / Suspended / Suspended Direct / Indirect
Acoustic panel type	MOSSwall® / Ecophon	MOSSwall® / Ecophon	MOSSwall® / Ecophon	MOSSwall® / Ecophon	Ecophon
Luminaire luminous flux	2600 - 10790 lm	5300 - 21800 lm	4800 - 13900 lm	9250 - 26100 lm	7000 - 20300 lm (C/S), 12500 - 34300 lm (SDI)
Light distribution	Direct	Direct / Indirect	Direct	Direct / Indirect	Direct / Indirect
Optics	SOP, DPR	SOP, DPR	SOP, DPR	SOP, DPR	SOP, DPR
LED colour	827, 830, 835, 840, 930, 940	827, 830, 835, 840, 930, 940	827, 830, 835, 840, 930, 940	827, 830, 835, 840, 930, 940	827, 830, 835, 840, 930, 940
Dynamic illumination	Tunable white 2700 - 6500K	Tunable white 2700 - 6500K	Tunable white 2700 - 6500K	Tunable white 2700 - 6500K	Tunable white 2700 - 6500K
Driver	Casambi, DALI, FO	Casambi, DALI, FO, TD	Casambi, DALI, FO	Casambi, DALI, FO, TD	Casambi, DALI, FO
Colour	1 2 B D	1 2 B D	1 2 B D	1 2 B D	1 2 B D
MOSSwall® colour					-
Sound absorbing surface	0,5 / 1,1 m ² (C), 1,0 / 2,2 m ² (S)	1,0 / 2,2 m ²	1,4 m ² (C), 2,8 m ² (S)	2,8 m ²	4,3 m ² (C), 8,6 m ² (S, SDI)
Dimensions	D (mm): 950, 1350	D (mm): 950, 1350 SH (mm): 1500, 3000, 5000		SH (mm): 1500, 3000, 5000	

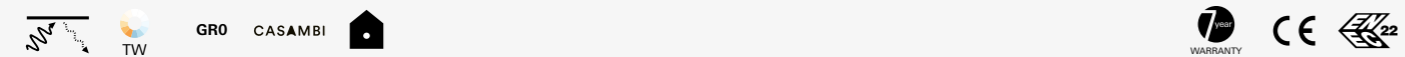
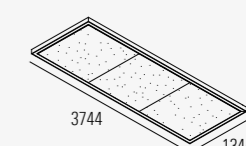
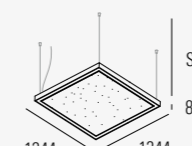
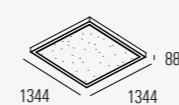
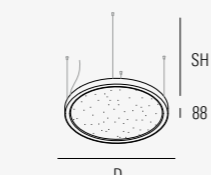
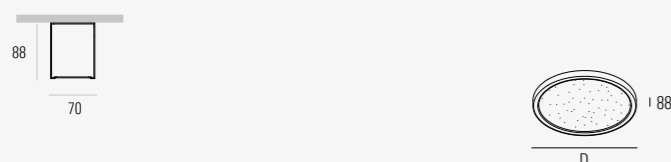

Light source: High-flux PCB LED modules, mid-power SMD LED, CRI>80/90, MacAdam≤2, 50.000h L90 B10 at 35°C. **Optic:** Satin opal diffuser (SOP) or soft-light prismatic optics (DPR) from polycarbonate for direct light. Satin opal polycarbonate diffuser (SOP) for indirect light. **Body:** Extruded aluminium curved profile, powder coated with acoustic Ecophon or MOSSwall® central plate. **Ceiling cup:** For suspended versions, the ceiling cup and suspension set must be ordered separately. Find out more on the technical pages or online product configurator. **Control gear:** Integrated highly-efficient driver with fixed output (FO) or dimmable (DALI-TD, Casambi). Optional separate switching for direct / indirect versions. **Power supply:** 230V 50Hz.

Svetlobni vir: PCB LED moduli visoke svetilnosti, z SMD LED, CRI>80/90, barvno odstopanje MacAdam≤2, 50.000 h L90 B10 na 35 °C. **Optika:** Satinirani opalni polikarbonatni difuzor (SOP) ali mikro-prizmatična difuzna PMMA optika (DPR) za direktno osvetlitev in opalni polikarbonatni difuzor (SOP) za indirektno osvetlitev. **Ohišje:** Ukrivljeni profil iz ekstrudiranega aluminija, prašno barvan s centralno akustično ploščo iz Ecophon ali MOSSwall® materiala. **Stropna rozeta:** Za viseče verzije se rozete in vešala naročajo posebej. Več na straneh s tehnično vsebino ali v spletnem konfiguratorju. **Napajalnik:** Integriran visoko učinkoviti LED konverter s konstantnim tokom (FO) ali regulacijskim izhodom (DALI-TD, Casambi). Opcijsko ločeno prižiganje direktne / indirektno komponente. **Napajanje:** 230 V 50 Hz.

Izvor svetla: PCB LED moduli velikog svetlosnog toka, SMD LED srednje snage, CRI>80/90, MacAdam≤2, 50.000 h L90 B10 na 35 °C. **Optika:** Satinirani opalni difuzor (SOP) ili polikarbonatna prizmatična optika (DPR) za direktnu komponentu. Satinirani opalni polikarbonatni difuzor (SOP) za indirektnu komponentu. **Kućište:** Zakrivljeni profil od ekstrudiranog aluminija, elektrostatski plastificiran, s centralnom akustičnom pločom od Ecophon ili MOSSwall® materijala. **Stropna rozeta:** Za ovjesne inačice, stropna rozeta i ovjesni pribor moraju biti naručeni zasebno. Otkrij više na tehničkim stranicama ili online konfiguratoru proizvođača. **Predspojne naprave:** Integrirana visoko efikasna predspojna naprava konstantnog izlaza (FO) ili dimabilna (DALI-TD, Casambi). Odvojeno paljenje direktne/indirektno komponente na zahtjev. **Napajanje:** 230 V 50 Hz.



BY CHICAGO ATHENAEUM

DESIGN PLUS
powered by light+building



red dot design award
winner



Tracker

Goes with the flow

Created to create

Tracker is made to track the fluid architecture and is by far our most adjustable trim-less luminaire when it comes to shapes.

Tracker is the first luminaire to go beyond horizontal movement and introduce endless possibilities to follow vertical lines in the space as well. With its ability to adapt to wall or ceiling radius (+/-500 mm), Tracker can vary from bold and artistic to a luminaire that discreetly blends in and supports the creativity of the architect or lighting designer. And it's not only about its clean looks; it's also about the hidden logic of this luminaire, as it fits perfectly with standard construction elements.

Ustvarjen za ustvarjanje

Namen svetila Tracker je, da sledi linijam fluidne arhitekture, in je kot takšno zagotovo eno izmed tistih svetil, ki se s svojo obliko z lahkoto prilagajajo formam brez konca in začetka.

Tracker je prvo svetilo, ki ponuja več kot le gibanje po horizontalni liniji. Odpira novo poglavje možnosti ustvarjanja in premikanja po navpičnih linijah, saj se z lahkoto prilagaja raznim stenskim in stropnim naklonom (+/-500 mm). Prav zaradi svoje vseplosne prilagodljivosti vam svetilo Tracker ponuja toliko manevrskega prostora, kot ga potrebujete, saj lahko z njim ustvarite nekaj markantnega in umetniškega, ali pa ga diskretno umestite v prostor in poudarite čist dizajn arhitekture. Smo omenili, da se njegovi elementi popolno ujemajo s standardnimi merami gradbenih elementov? Ker se.

Stvoren da bi stvarao

Tracker je napravljen za pračenje fluidne arhitekture i jedno je od naših najprilagodljivijih rasvjetnih tijela bez vidljivog ruba kada se radi o oblicima.

Tracker je prvo rasvjetno tijelo koje nadilazi horizontalne kretnje i također uvodi beskrajne mogućnosti za pračenje vertikalnih linija u prostoru. Uz sposobnost prilagodbe zidnim i stropnim omjerima (+/- 500 mm), Tracker može varirati od odvažnog i umjetničkog rasvjetnog tijela do onog koje se diskretno uklapa i podržava kreativnost arhitekta ili dizajnera rasvjete. Ne radi se samo o njegovom čistom izgledu; već i o skrivenoj logici ovog rasvjetnog tijela, jer se savršeno uklapa u standardne konstrukcijske elemente.











Tracker LR 45°, 90°

Bending with the ceiling

Tracker UD (up/down) is made to track the fluid architecture. It literally bends with the ceiling to track different ceiling radius and adapts to both, concave and convex surfaces.

Tracker UD

MAIN FEATURES

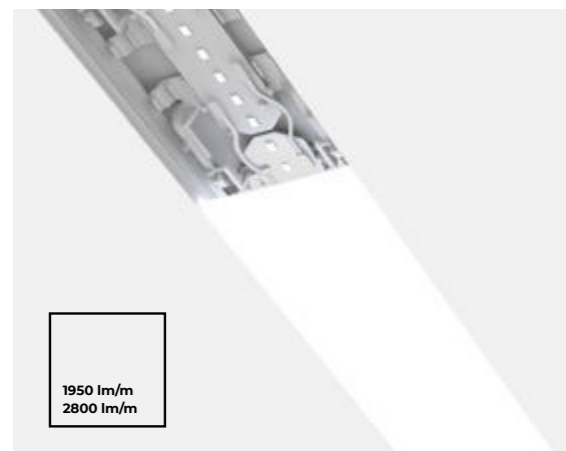

1950 lm/m
2800 lm/m

Strong and reliable

High light output, superb light quality and durability make this product more than a decorative element in the space. It's made to last.

Goes under the primary ceiling construction

Tracker fits perfectly with standard construction elements. Cutting primary ceiling profiles is not necessary due to the product height.

Plaster thickness (mm): 12,5 / 15,8 / 25

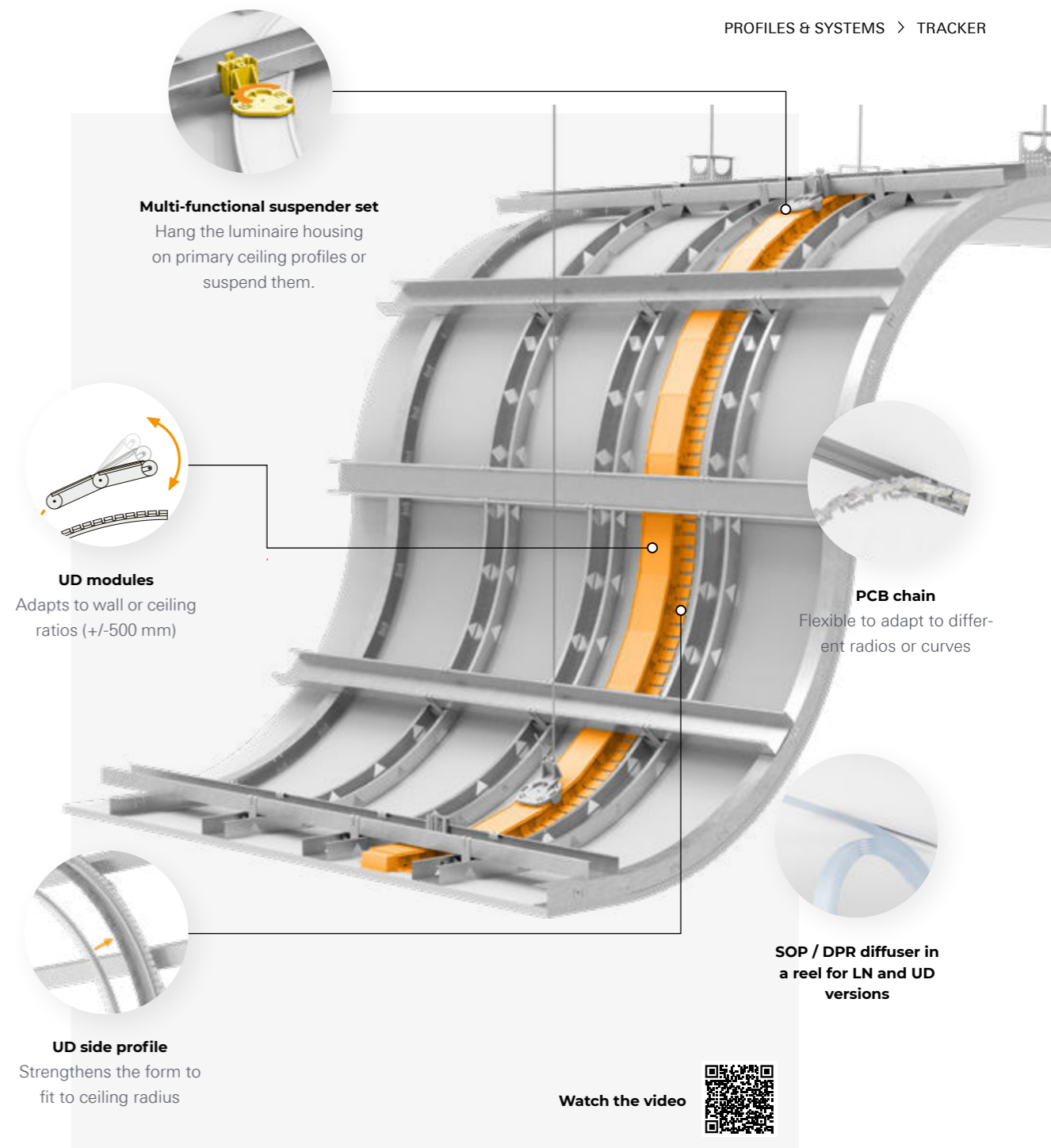
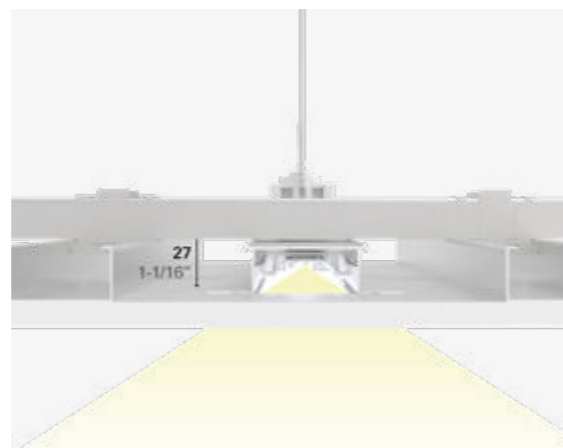

Multi-functional suspender set

Hang the luminaire housing on primary ceiling profiles or suspend them.

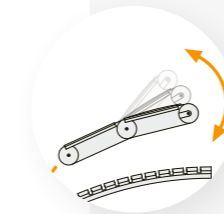

UD modules

Adapts to wall or ceiling ratios (+/-500 mm)



PCB chain

Flexible to adapt to different radii or curves



UD side profile

Strengthens the form to fit to ceiling radius



SOP / DPR diffuser in a reel for LN and UD versions

Watch the video

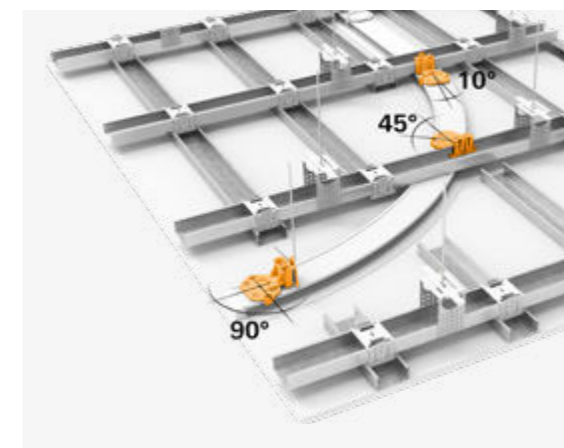

Simple installation

The installation of linear and curved modules is simple due to innovative installation tools and product construction. Cutting the primary ceiling profiles is not required, so it does not weaken the ceiling load capacity.

Tracker

Technical Overview



RI LN
Linear

RI LR 45° / 90°
Curved left/right

RI UD
Up/down

Luminaire luminous flux/m*	1700 lm/m, 2400 lm/m	1700 lm/m, 2400 lm/m	1700 lm/m, 2400 lm/m
Optics	Diffuser in a reel SOP, DPR	SOP, DPR	Diffuser in a reel SOP, DPR
LED colour	827, 830, 840, 930, 940	827, 830, 840, 930, 940	827, 830, 840, 930, 940
Driver	Casambi, DALI, FO (24V remote)	Casambi, DALI, FO (24V remote)	Casambi, DALI, FO (24V remote)
Colour	1	1	1
Dimensions	L (mm): 950 - 3040	L (mm): 1140 - 3040 R (mm) 726 - 3871	L (mm): 950, 4750 R min/max (mm): 500

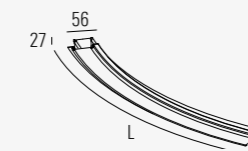
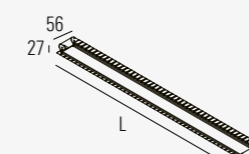
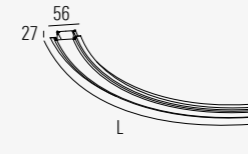
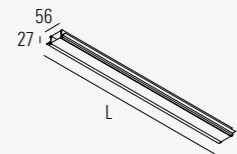

* Data refer to 840 LED colour, SOP diffuser



Light source: High-flux PCB LED modules, mid-power SMD LED, CRI>80/90, MacAdam≤2.5, 50.000h L80 B10 at 35°C. **Optic:** Satin opal polycarbonate diffuser (SOP), Soft-light prismatic PMMA diffuser (DPR). **Body:** Flexible polycarbonate module with construction profile holders and curved aluminium side profile. **Control gear:** Constant voltage driver - order separately. **Power supply:** 24V DC.

Svetlobni vir: High-flux PCB LED moduli, z SMD LED, CRI>80/90, MacAdam≤2.5, 50.000 h L80 B10 na 35 °C. **Optika:** Satinirani opalni polikarbonatni difuzor (SOP), Mikro-prizmatična difuzna PMMA optika (DPR). **Ohišje:** Fleksibilni modul iz polikarbonata z nosilci za pritrjevanje na konstrukcijo in ukrivljenim stranskim aluminijastim profilom. **Napajalnik:** LED konverter s konstantno napetostjo - ločeno naročanje. **Napajanje:** 24 V DC.

Izvor svjetla: PCB LED moduli velikog svjetlosnog toka, SMD LED srednje snage, CRI>80/90, MacAdam≤2.5, 50.000 h L80 B10 na 35 °C. **Optika:** Satinirani opalni polikarbonatni difuzor (SOP), Mikroprizmatična difuzna PMMA optika (DPR). **Kućište:** Fleksibilni modul od polikarbonata s nosačima profila i zakrivljeni krajnji profil od aluminija. **Predspojne naprave:** Predspojna naprava konstatnog napona- naručiti zasebno. **Napajanje:** 24 V DC.

Wide choice of standard modules

Create your perfect light composition with a variety of standard light modules that give you freedom to combine them together in a different way.

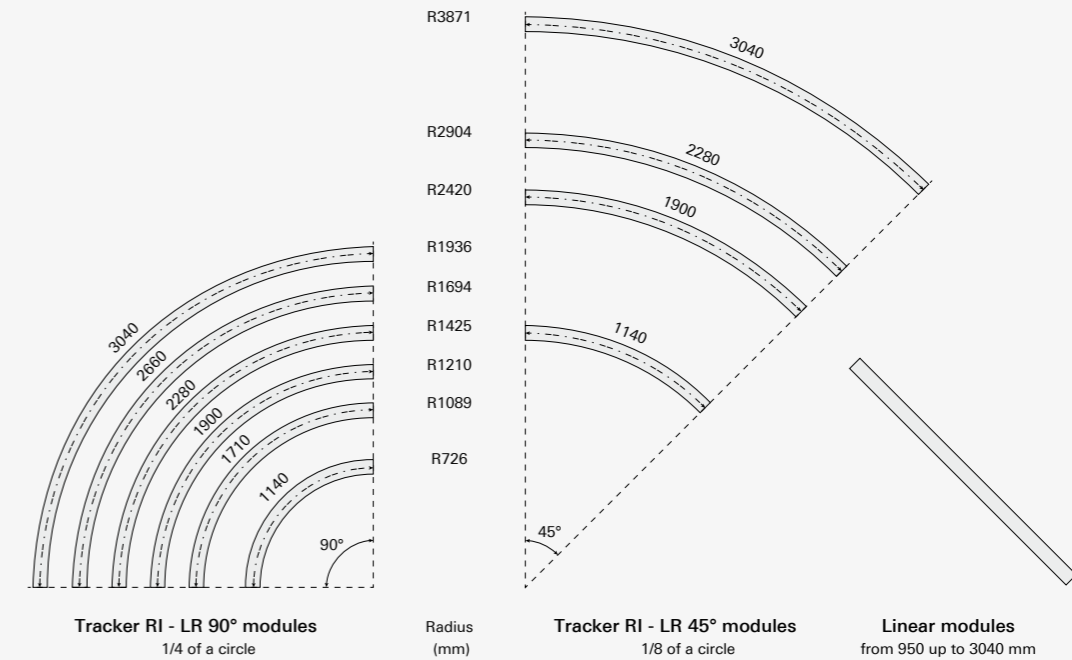

Tracker UD modules

Select from two standard lengths. Each module can be easily replaced, connected together or removed in case you need a shorter length.

950 mm length includes:

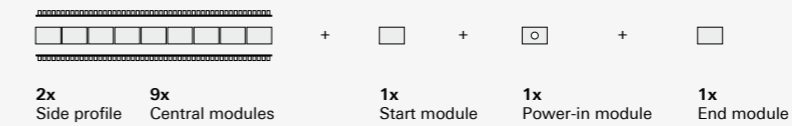

4750 mm length includes:

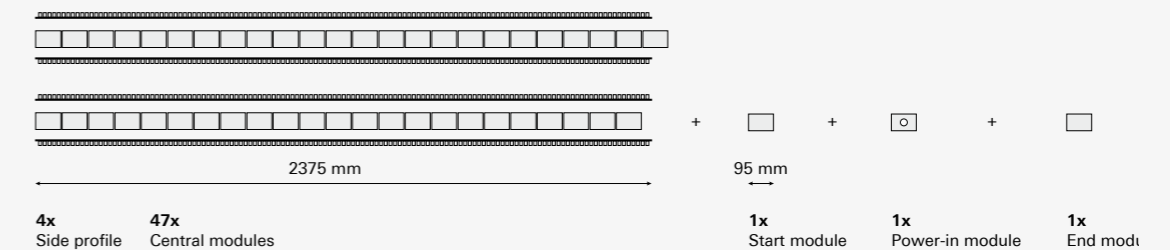



Sword

Power comes with size

Bigger the scale, bigger the challenge

Size matters. Sword is a powerful luminaire, appropriate for high ceilings or situations where you need a bigger size profile when defining a space. It offers a uniform general illumination that is simply efficient.

It's flexible and modular in its possibilities, available as a single luminaire or as a lighting system that allows different options. Upgrades can include tracks, up light or longer lines.

Večje dimenzije, večji izziv

Velikost šteje. Sword je močno svetilo, primerno za visoke stropove ali priložnosti, ko prostor zahteva večje profile. Svetilo zagotavlja enakomerno splošno razsvetljavo, ki je preprosto učinkovita.

Svetilo je zelo prilagodljivo in modularno. Na voljo je kot samostojno svetilo ali kot svetlobni sistem, ki omogoča različne možnosti. Nadgradnja lahko vsebuje tračnice, indirektno osvetlitev ali daljše linije.

Veće dimenzije, veći izazov

Veličina je važna. Sword je močno rasvjetno tijelo, prikladno za visoke stropove ili za slučajeve kada vam je potreban veći profil prilikom definiranja prostora. Ono nudi ravnomjernu opću rasvjetu koja je jednostavno učinkovita.

Njegove mogućnosti nude fleksibilnost i modularnost, dostupno je kao jedno rasvjetno tijelo ili kao sustav rasvjete koji nudi razne mogućnosti. Nado gradnje mogu sadržavati vodilice, gornje svjetlo i dulje vodove.





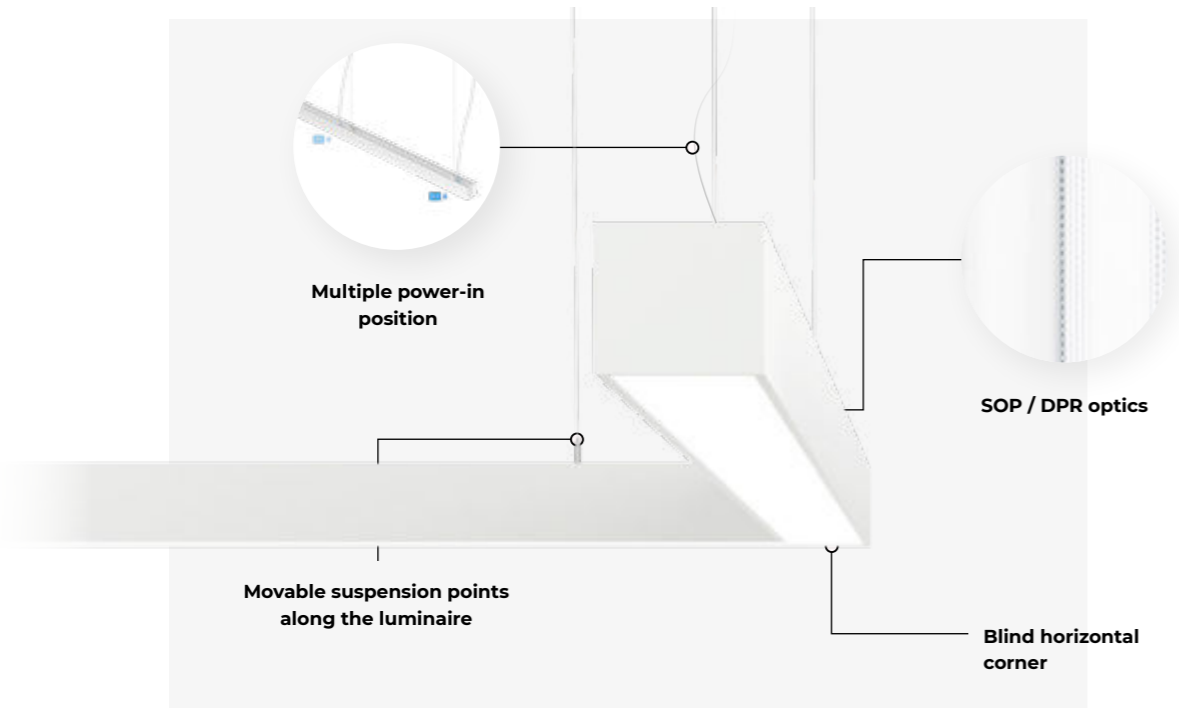

MAIN FEATURES

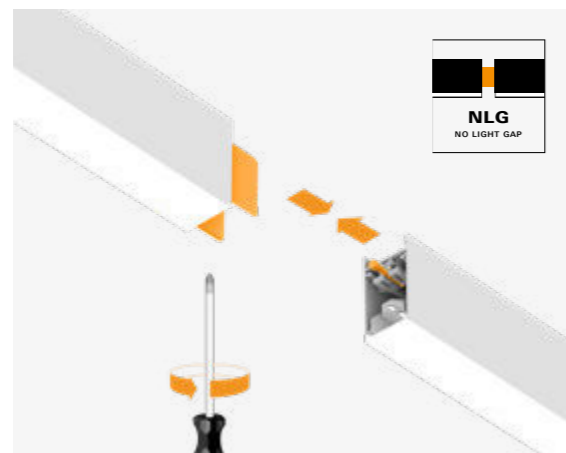

Perfect joints, no light gaps

With an innovative twist and lock joint element, the assembly between two modules is now quick and easy, and the profiles are strongly connected with no risk of bending. The light has absolutely no possibilities to escape.

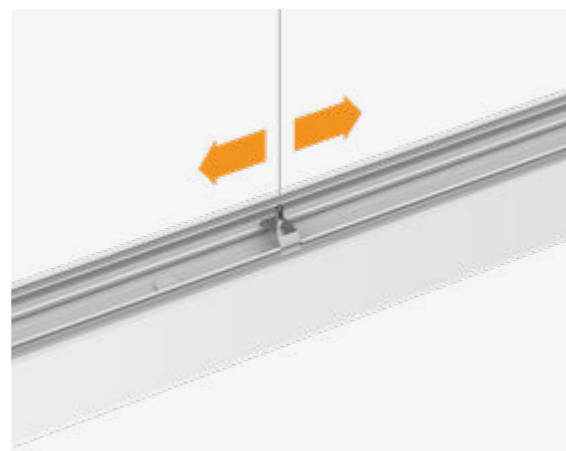

Movable suspension points

The suspension can be moved along the luminaire to ensure optimal mounting on your ceiling. Only one suspension per joint is needed instead of two. In case of indirect illumination movement is limited.

Sword

Technical Overview

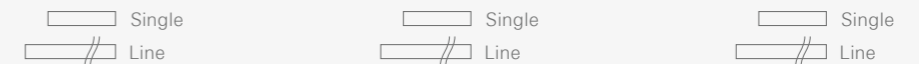
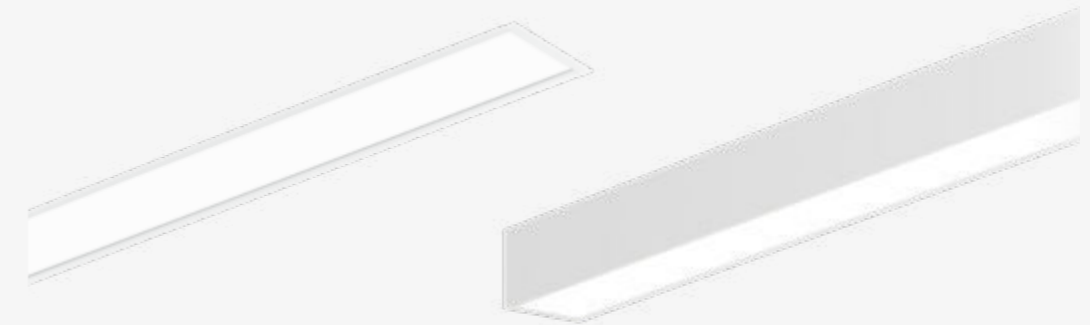

	RV Recessed visible trim	C/S Ceiling / Suspended	SDI Suspended Direct / Indirect
Luminaire luminous flux/m	1650 - 4300 lm/m	1650 - 4300 lm/m	2150 - 5900 lm/m
Light distribution	Direct	Direct	Direct / Indirect
Optics	SOP, DPR	SOP, DPR	SOP, DPR
LED colour	827, 830, 835, 840, 930, 940	827, 830, 835, 840, 930, 940	827, 830, 835, 840, 930, 940
Dynamic illumination	Tunable white 2700 - 6500K	Tunable white 2700 - 6500K	Tunable white 2700 - 6500K
Driver	Casambi, DALI, FO	Casambi, DALI, FO	Casambi, DALI, FO
Emergency kit	EM 1h / 3h	EM 1h / 3h	EM 1h / 3h
Colour	1 2	1 2	1 2
Dimensions	L (mm): 584 - 3104	L (mm): 576 - 3096	L (mm): 842 - 3096 SH (mm): 1500, 3000, 5000

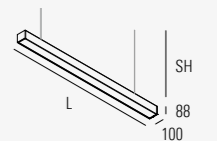
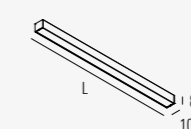
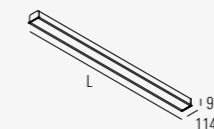

Light source: High-flux PCB LED modules, mid-power SMD LED, CRI>80/90, MacAdam \leq 2, 50.000h L90 B10 at 35°C. **Optic:** Satin opal diffuser (SOP) or soft-light prismatic optics (DPR) from polycarbonate for direct light. Satin opal polycarbonate diffuser (SOP) for indirect light. **Body:** Extruded aluminium profile, powder coated. **Ceiling cup:** For suspended versions, the ceiling cup and suspension set must be ordered separately. Find out more on the technical pages or online product configurator. **Control gear:** Integrated highly-efficient driver with fixed output (FO) or dimmable (DALI-TD, Casambi). Optional separate switching for direct / indirect versions. **Emergency:** Emergency kit version with autonomy 1h or 3h. **Power supply:** 230V 50Hz.

Svetlobni vir: PCB LED moduli visoke svetilnosti, z SMD LED, CRI>80/90, barvno odstopanje MacAdam \leq 2, 50.000 h L90 B10 na 35 °C. **Optika:** Satinirani opalni polikarbonatni difuzor (SOP) ali mikro-prizmatična difuzna PMMA optika (DPR) za direktno osvetlitev in opalni polikarbonatni difuzor (SOP) za indirektno osvetlitev. **Ohišje:** Ekstrudiran profil iz aluminija, prašno barvan. **Stropna rozeta:** Za viseče verzije se rozete in vešala naročajo posebej. Več na straneh s tehnično vsebino ali v spletnem konfiguratorju. **Napajalnik:** Integriran visoko učinkoviti LED konverter s konstantnim tokom (FO) ali regulacijskim izhodom (DALI-TD, Casambi). Opcijsko ločeno prižiganje direktne / indirektno komponente. **Varnostni modul:** Varnostni modul z 1 ali 3 urami avtonomije. **Napajanje:** 230 V 50 Hz.

Izvor svetla: PCB LED moduli velikog svetlosnog toka, SMD LED srednje snage, CRI>80/90, MacAdam \leq 2, 50.000 h L90 B10 na 35 °C. **Optika:** Satinirani opalni difuzor (SOP) ili polikarbonatna prizmatična optika (DPR) za direktno komponentu. Satinirani opalni polikarbonatni difuzor (SOP) za indirektno komponentu. **Kućište:** Ekstrudirani aluminij-ski profil, elektrostatski plastificiran. **Stropna rozeta:** Za ovesne inačice, stropna rozeta i ovesni pribor moraju biti naručeni zasebno. Otkrij više na tehničkim stranicama ili online konfiguratoru proizvođača. **Predspojne naprave:** Integrirana visoko efikasna predspojna naprava konstantnog izlaza (FO) ili dimabilna (DALI-TD, Casambi). Odvojeno paljenje direktne/indirektno komponente na zahtjev. **Režim nužne rasvjete:** Modul nužne rasvjete avtonomije 1 ili 3h. **Napajanje:** 230 V 50 Hz.



Cut

Hides everything

Ceilings love it

And Cut loves ceilings. Especially those of large classy stores where you really want your products to stand out and at the same time, to hide everything else.

Cut provides a clear and elegant solution with the possibility to integrate everything into it. From flexible spots and linear luminaires to cameras and loudspeakers. It gives maximum modularity, and leaves your ceiling clean and your customer's attention focused.

Stropi ga obožujejo

In Cut obožuje njih. Posebej tiste v velikih elegantnih trgovinah, ko želite, da vaši izdelki izstopijo, in hkrati skriti vse ostalo.

Cut zagotavlja čisto in elegantno rešitev z možnostjo vgradnje različnih modulov – od fleksibilnih reflektorjev, linearnih svetil, do kamer in zvočnikov. Omogoča maksimalno modularnost. Vaš strop bo čist, pozornost strank pa na pravem mestu.

Stropovi ga vole

I Cut voli stropove. Pogotovo one u velikim, otmjernim trgovinama u kojima odista želite da se vaši proizvodi istaknu, a da istovremeno sakrijete sve ostalo.

Cut pruža jasno i elegantno rješenje, rasvjetno tijelo u koje je moguće integrirati sve: od fleksibilnih reflektora i linearnih svjetiljki, do kamera i zvučnika. Pruža maksimalnu modularnost, strop čini neupadljivim i tako usredotočuje pozornost vaših kupaca.



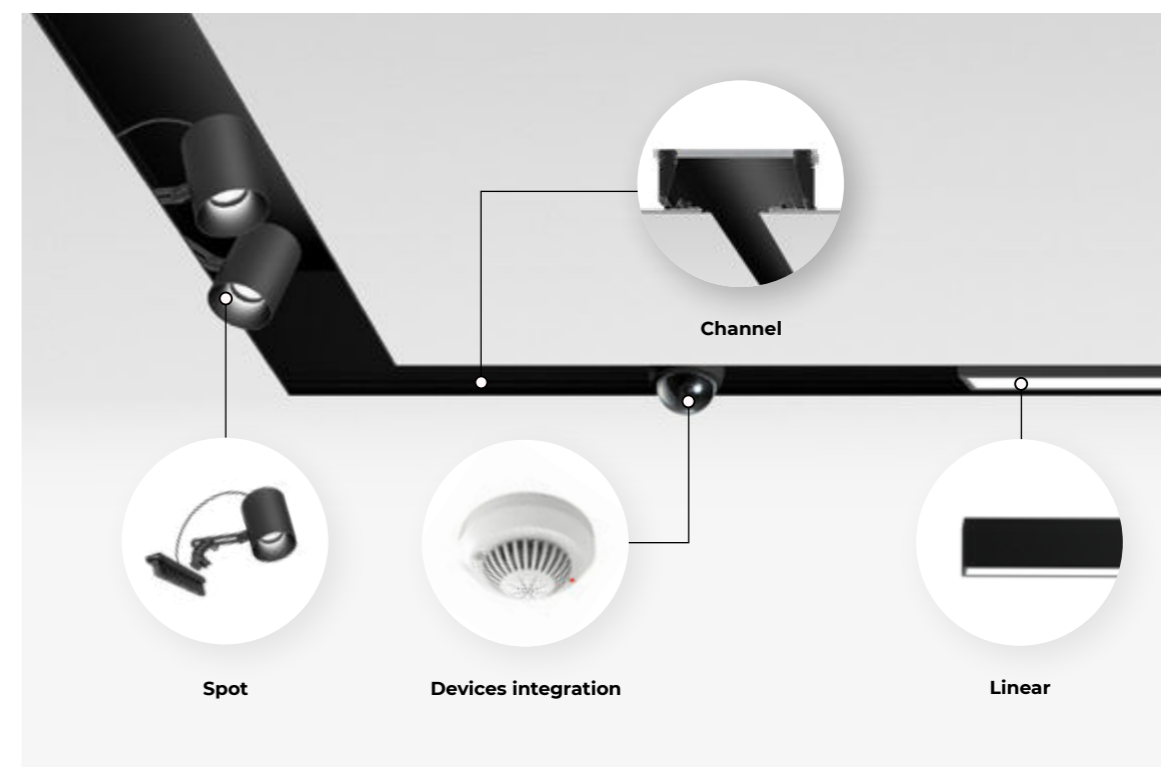

MAIN FEATURES



Double-sided channel

Use the double channel for situations when you want a clean ceiling, and hide all the different (light) modules inside the channel. There will be no more unaesthetic installations everywhere but a clean, flexible, and multifunctional system that connects everything.

Single-sided channel

Mount the single profile or right beside the wall or when you want to finish the plaster ceiling edges nicely and have the possibility to illuminate the space with a flexible spot. It is an excellent solution for areas that combine open and suspended ceilings.



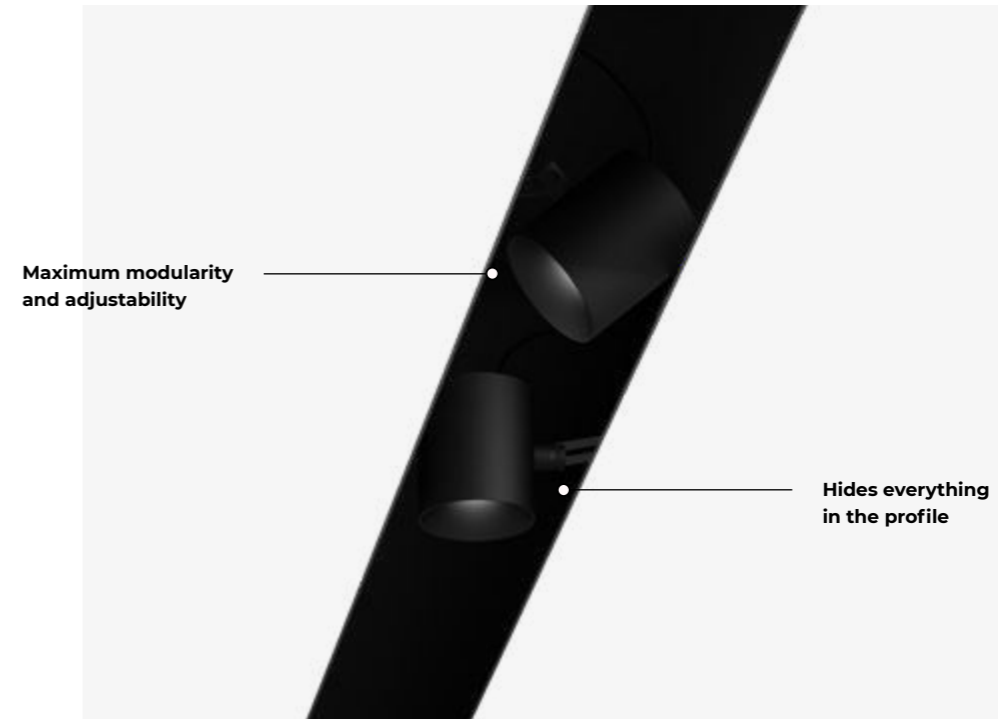
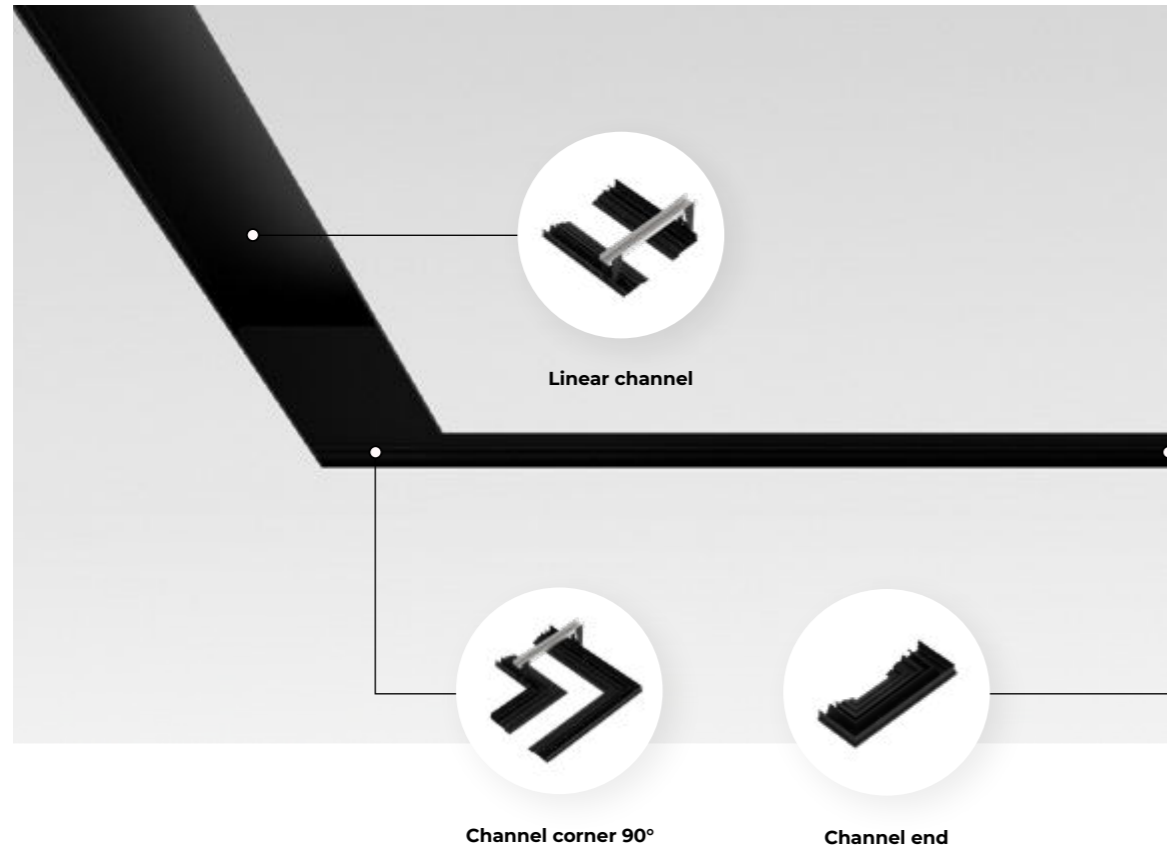

Fits to different ceiling types

Suitable for:

- Plasterboard ceiling (12,5; 15,8 and 25 mm)
- T-bar ceilings with different acoustic plates (up to 40 mm)

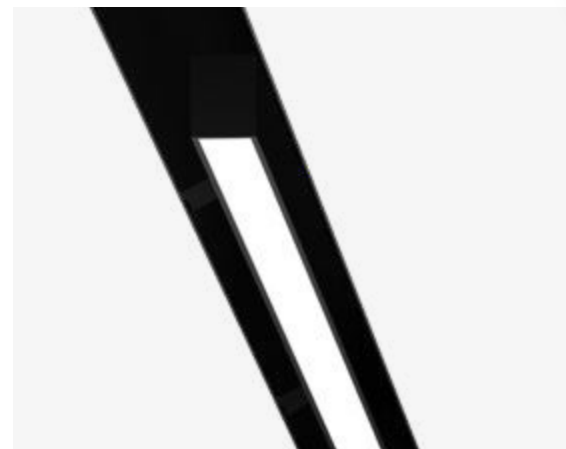
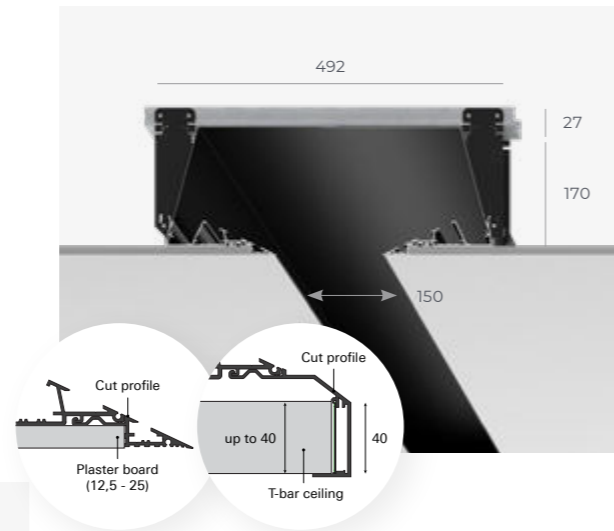

Uniform illumination

Whenever you need a high quality uniform illumination, linear light modules are the right choice.

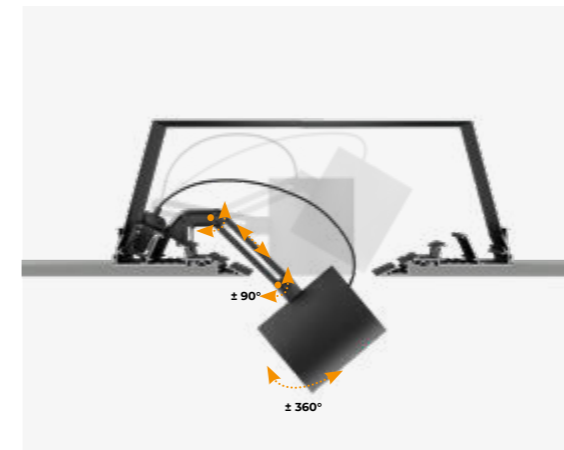

Maximum flexibility

You can adjust the spots in all directions. Besides the spotlight itself, the set also includes a console fastening mechanism, a track adapter with an integrated FO/DALI driver and a cable in between.

Move the spot, not the track

The track can be mounted on both sides of the channel and allows connection of modules from both sides.



Cut

Technical Overview



PROFILE TYPE



RI
Recessed trim-less

TECH. SPECS

CHANNEL TYPE	MODULES	LENGTH (L)
Double, Single	Linear, corner 90°, end	1000 - 3000 mm

COLOUR



BK

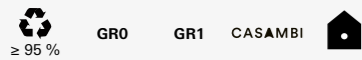

Recessed trim-less extruded aluminium profile system with integrated 230V track for power supply. Channel cover made from steel sheet, powder coated. Wide range of light insets and accessories (linear, spot) with integrated fixed output (FO) or dimmable driver (DALI-TD, Casambi).

Vgradni sistem z nevidnim robom iz ekstrudiranega aluminijskega profila z vgrajeno 230 V trifazno tračnico. Pokrov kanala iz dekapirane jeklene pločevine, prašno barvan. Širok nabor svetlobnih elementov (linearni, reflektorski) z vgrajenimi LED konverterji s konstantnim tokom (FO) ali regulacijskim izhodom (DALI-TD, Casambi).

Ugradni linijski sistem od ekstrudiranog aluminijskog profila za ugradnju s nevidljivim rubom, s ugrađenom 230V tračnicom za energetski razvod. Pokrov kanala izrađen od dekapiranog čelika, elektrostatski plastificiranog. Širok raspon rasvjetnih komponenti (linijske, spot) s integriranom predspojnom napravom konstantnog izlaza (FO) ili dimabilnom (DALI-TD, Casambi).

Channel

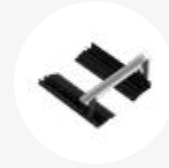

Linear channel
Dimensions: 1000, 2000, 3000 mm

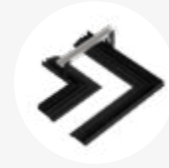

Channel corner 90°
Dimensions: 600x600 mm

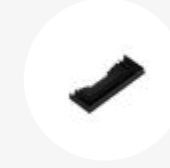

Channel end
Dimensions: 462, 170 mm



Channel cover
Dimensions: 462, 170 mm

Spot insets

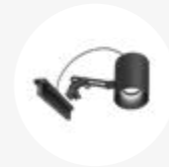

Pipes Cut TRS
Luminaire luminous flux: 720 - 3400 lm
Beam angle: 15°, 30°, 36°, 56° (PRO); 30°, 40°, 60° (DECO)
LED colour: 830, 835, 840, 927, 930, 940
Driver: FO, DALI

Track



Track
Length: 1000 - 3000 mm
3 phase track with DALI line

Linear insets



Gyon C
Luminaire luminous flux/m: 800 - 2880 lm/m
Module length: 800 - 2880 lm/m
Optic: SOP, DPR, HMP, LDP (UGR<19), AS
LED colour: 827, 830, 835, 840, 930, 940
Driver: Casambi, DALI, FO



Sword C
Luminaire luminous flux/m: 1670 - 4250 lm/m
Module length: 1670 - 4250 lm/m
Optic: SOP, DPR
LED colour: 827, 830, 835, 840, 930, 940
Driver: Casambi, DALI, FO

Device holders

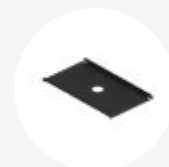

Holder
Security camera holder
Fire sensor holder
Ceiling speaker holder

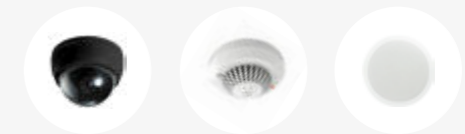



Edge

Light graphics

Push your ideas over the edge

Create graphics with light or soften your edges with a luminaire that offers an effect of pure light, without really seeing the product.

Edge can be discreetly blended into your ceiling or wall, and at the same time provide uniform and controlled illumination. It comes in dimensions that fit your plaster ceiling like a glove and focus attention just where it needs to be. It's a luminaire that brings your space to life.

Go straight to the Edge if you plan a hotel lobby, corridors or representative spaces to create an atmosphere; use it in pubs, bars and restaurants to elevate the mood or simply light up signalisation that cannot be ignored.

Svoje ideje potisnite preko roba

Ustvarite svetlobno grafiko ali zmečajte robove s svetilom, pri katerem se svetloba vidi, njen vir pa ne.

Edge se lahko diskretno zlije vašim stropom ali steno in istočasno zagotovi enakomerno in kontrolirano svetlobo. Njegove dimenzije se prilegajo dimenzijam mavčnih plošč. Usmerja pozornost in v prostor vnaša življenje.

Odlično se znajde v hotelskih lobijih, hodnikih in drugih večjih prostorih, v katerih je ključen izziv ustvarjanje prijetnega vzdušja, uporabite pa ga lahko tudi v barih in restavracijah ali pa za signalizacijo, ki je preprosto ni mogoče prezreti.

Prekoračite granice sa svojim idejama

Stvorite grafiko svetlom ili ublažite robove pomoću rasvjetnog tijela koje pruža efekt čistog svjetla, pri čemu se proizvod ne vidi.

Edge se može diskretno uklopiti na vaš strop ili zid, a istodobno osigurati ujednačeno i kontrolirano osvjetljenje. Dolazi u dimenzijama koje savršeno pristaju vašem gipsanom stropu i usmjeravaju pozornost upravo tamo gdje je potrebno. Ovo rasvjetno tijelo oživljava vaš prostor.

Odmah odaberite Edge ako planirate predvorje hotela, hodnike ili reprezentativne prostore kako biste stvorili atmosferu; koristite ga u pubovima, barovima i restoranima za podizanje raspoloženja ili jednostavno uključite rasvjetu koja se ne može ne primijetiti.







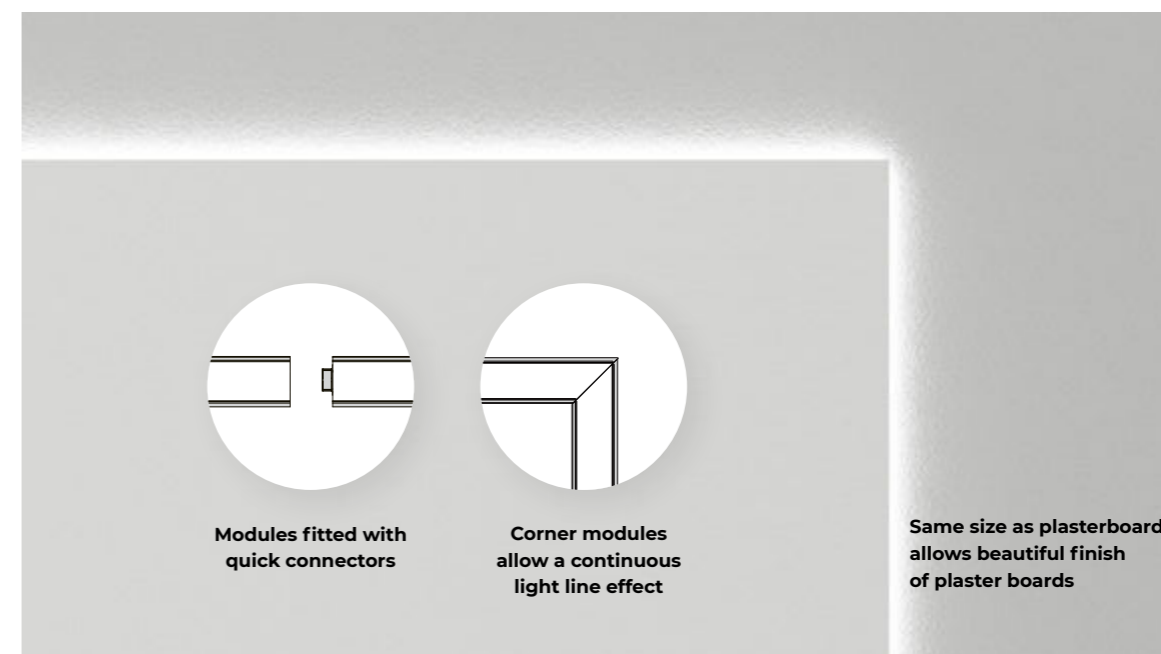

MAIN FEATURES

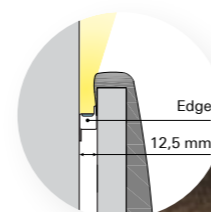

Create the atmosphere

Edge brings calm to a room and adds elegant details. You can use it to create an ambient illumination or as a light that helps navigate you at night.

Elevate the space

Edge makes the room look more relaxed and adds elegant details. You can use it to create an ambient illumination or as a light that helps navigation in the night-time.



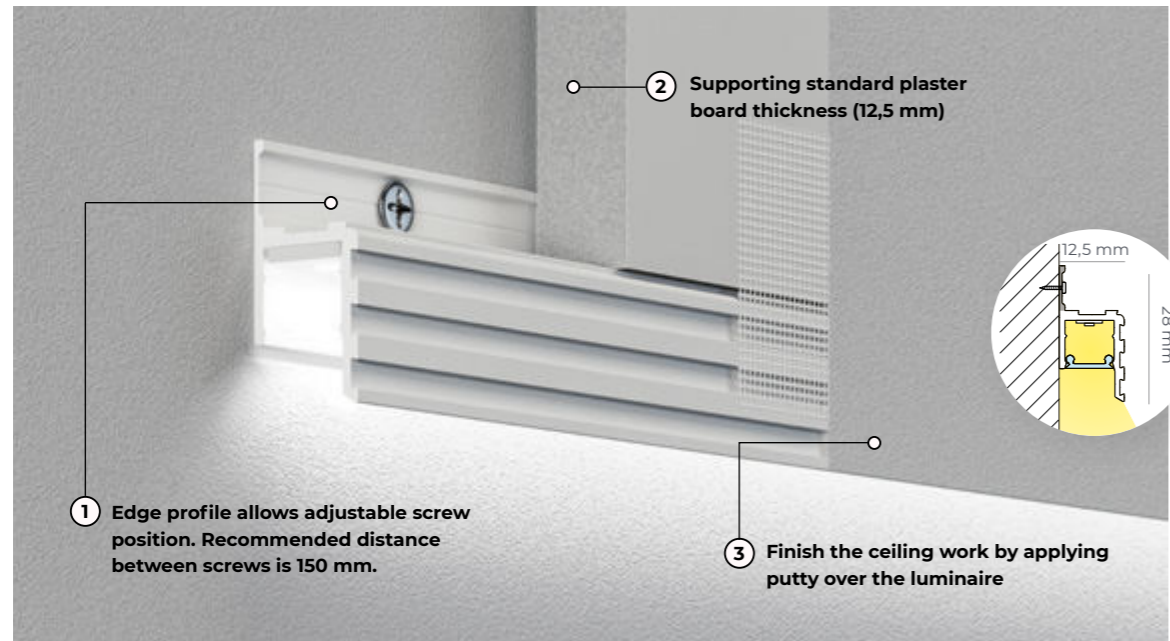

FOR DIFFERENT KINDS OF COVES

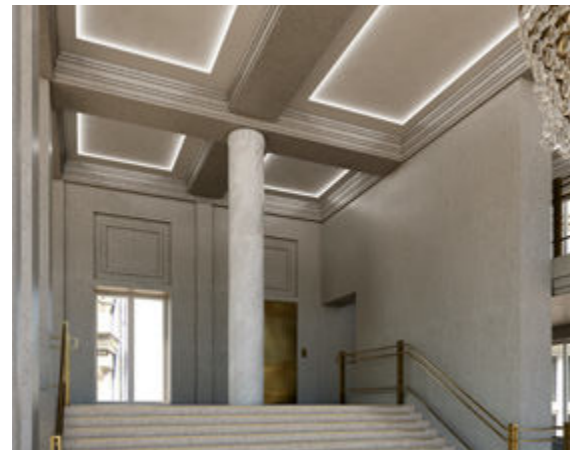

A nice edge of a plaster ceiling

Edge can bring a nice light effect to a space and allows a perfect end and appearance of the ceiling or wall. By applying the mesh tape over the luminaire, putting details will be even and smooth, without cracks.

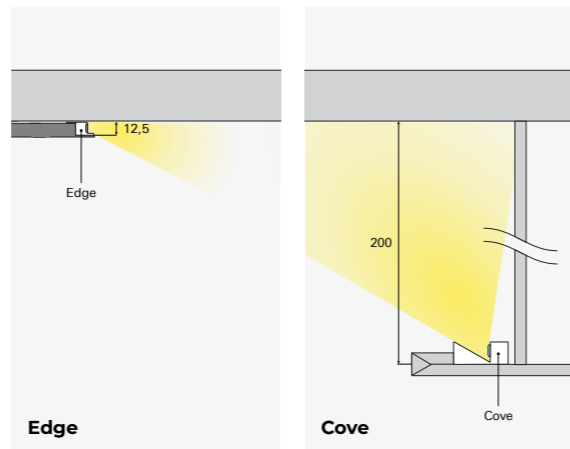

Minimum height, maximum effect

When you want to create a light effect and you have a minimum height available, use Edge. Use Cove with cove applications, for creating a diffused light effect that is decorative and functional at the same time.

Edge

Technical Overview



	Linear	Corner external	Corner internal
Luminaire luminous flux/m	690 - 1300 lm/m	690 - 1300 lm/m	670 - 1250 lm/m
LED colour	827, 830, 840, 930, 940	827, 830, 840, 930, 940	827, 830, 840, 930, 940
Optic	SOP	SOP	SOP
Driver	Casambi, DALI, FO	Casambi, DALI, FO	Casambi, DALI, FO
Driver position	Remote	Remote	Remote

Colour	1	1	1
Dimensions	L (mm): 416 - 2002	L (mm): 547 - 2049	L (mm): 547 - 2049



Light source: High-flux PCB LED modules, mid-power SMD LED, CRI>80/90, MacAdam≤2, 50.000h L90 B10 at 35°C. **Optic:** Satin opal polycarbonate diffuser (SOP). **Body:** Extruded aluminium profile, powder coated. **Control gear:** Constant voltage driver - order separately. **Power supply:** 24V DC.

Svetlobni vir: PCB LED moduli visoke svetilnosti, z SMD LED, CRI>80/90, barvno odstopanje MacAdam≤2, 50.000 h L90 B10 na 35 °C. **Optika:** Satiniran opalni polikarbonatni difuzor (SOP). **Ohišje:** Ekstrudirani profil iz aluminija, prašno barvan. **Napajalnik:** LED konverter s konstantno napetostjo - ločeno naročanje. **Napajanje:** 24 V DC.

Izvor svetla: PCB LED moduli velikog svjetlosnog toka, SMD LED srednje snage, CRI>80/90, MacAdam≤2, 50.000 h L90 B10 na 35 °C. **Optika:** Satinirani opalni polikarbonatni difuzor (SOP). **Kućište:** Ekstrudirani aluminijski profil, elektrostatski plastificiran. **Predspojne naprave:** Predspojna naprava konstatnog napona- naručiti zasebno. **Napajanje:** 24 V DC.



Cove

It's all light

Feel the light

Give your space the feeling of a light flooding in or put it in under cascades and shelves to light up things that need to be seen. Cove is a light that can be decorative, functional or both at the same time as it always creates a uniform light with an elegant touch.

Place it in a hotel lobby or room and make your guests feel welcome; use it in a closet, under cascades and shelves or blend it with hallway interiors to give your visitors that extra feeling of warmth. Cove will make you see only the light, and not the luminaire.

Občutite svetlobo

Ustvarite občutek, da je prostor preplavljen sončno svetlobo, ali poudarite, kar je treba, tako, da svetilo Cove namestite pod kaskade in police. To svetilo je lahko dekorativno ali funkcionalno, saj poleg oddajanja enakomerne svetlobe daje prostoru pridih elegance.

Pri svetilu Cove je svetloba vidna, njen vir pa ne. Postavite ga v hotelsko preddverje ali sobo in poskrbite za dobro počutje gostov. Uporabite ga v omarah, pod kaskadami ali policami, na hodnikih in z njim ustvarite občutek topline.

Osjetite svjetlo

Stvorite osjećaj da je prostor preplavljen sunčevom svjetlošću ili naglasite što je potrebno postavljanjem Cove lampe ispod kaskada i polica. Ova svjetiljka može biti dekorativna ili funkcionalna, jer osim što emitira ujednačenu svjetlost, daje prostori dodir elegancije.

Uz Cove ćete vidjeti samo svjetlost, a ne i rasvjetno tijelo. Postavite ga u hotelsko predvorje ili sobu i učinite da se vaši gosti osjete dobrodošlo; upotrijebite ga u ormaru, ispod pregrada namještaja i policama ili ga stopite s interijerima hodnika kako biste svojim posjetiteljima pružili dodatni osjećaj topline.





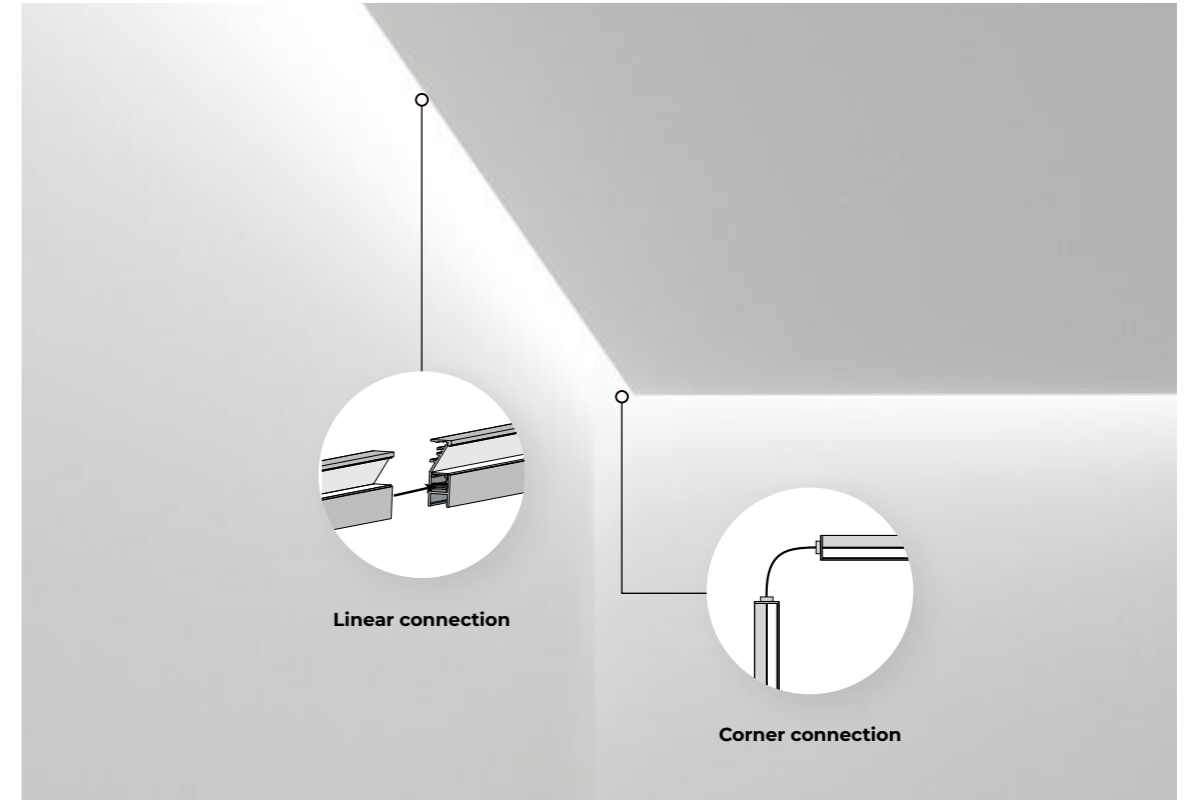

MAIN FEATURES



Wall cascade

Cove 25 with vertical diffuser softly disperses the light to the wall or ceiling, making it suitable for all kinds of ambient applications especially cascades.



Cascade on the ceiling

Use Cove 25 for creating a diffused light effect. With Cove applications, you can achieve both decorative and functional effects.



Shelf application

Cove 12 V does not emit light backwards and is therefore suitable for more specific applications like shelves and counter tops. Mounting Cove into the furniture requires the recessed round end cap.

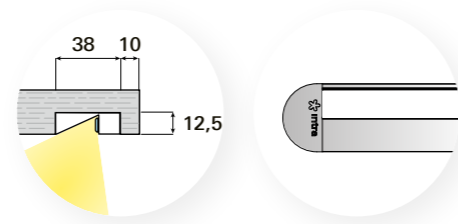

Simple installation

1. Screw the mounting clamp into the desired ceiling position.
2. Push Cove on the clamp until you hear the click.
3. The luminaire is now ready to be connected to the power.

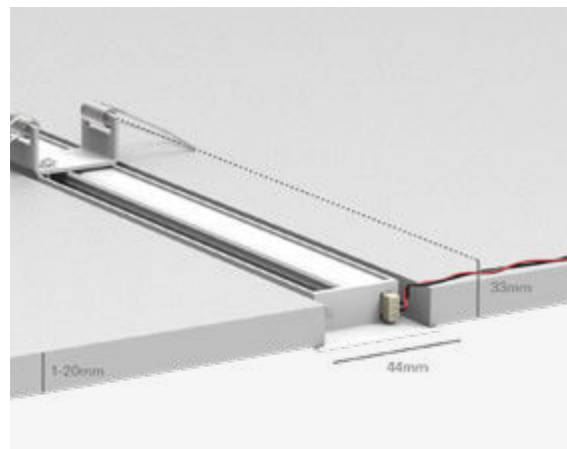

Suitable for the lowest ceiling thickness

Cove RV is suitable for ceilings of different thickness - from 1 to 20 mm.

Cove

Technical Overview



RV Recessed visible trim



C Ceiling



	12 H Horizontal diffuser	12 V Vertical diffuser	25 V Vertical diffuser
Luminaire luminous flux/m	720 - 1300 lm/m	580 - 1100 lm/m	580 - 1100 lm/m
Optics	SOP	SOP	SOP
LED colour	827, 830, 840, 930, 940	827, 830, 840, 930, 940	827, 830, 840, 930, 940
Driver	Casambi, DALI, FO	Casambi, DALI, FO	Casambi, DALI, FO
Driver position	Remote	Remote	Remote
Colour	1 2	1 2	1 2
Dimensions	L (mm): 400 - 2502	L (mm): 400 - 2502	L (mm): 400 - 2502

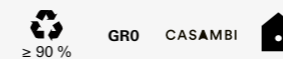
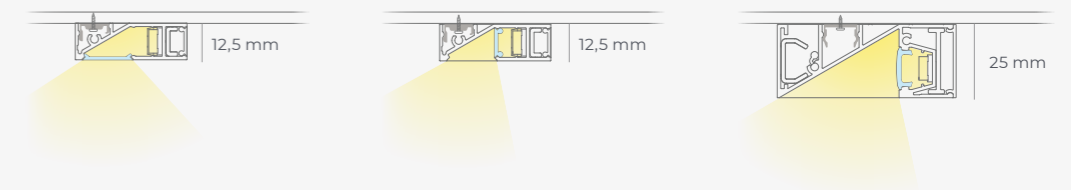

Light source: High-flux PCB LED modules, mid-power SMD LED, CRI>80/90, MacAdam≤2, 50.000h L90 B10 at 35°C. **Optic:** Satin opal polycarbonate diffuser (SOP). **Body:** Extruded aluminium profile, powder coated. **Control gear:** Constant voltage driver - order separately. **Power supply:** 24V DC.

Svetlobni vir: PCB LED moduli visoke svetlosti, z SMD LED, CRI>80/90, barvno odstopanje MacAdam≤2, 50.000 h L90 B10 na 35 °C. **Optika:** Satinirani opalni polikarbonatni difuzor (SOP). **Ohišje:** Ekstrudirani profil iz aluminija, prašno barvan. **Napajalnik:** LED konverter s konstantno napetostjo - ločeno naročanje. **Napajanje:** 24 V DC.

Izvor svetla: PCB LED moduli velikog svetlosnog toka, SMD LED srednje snage, CRI>80/90, MacAdam≤2, 50.000 h L90 B10 na 35 °C. **Optika:** Satinirani opalni polikarbonatni difuzor (SOP). **Kućište:** Ekstrudirani aluminijски profil, elektrostatski plastificiran. **Predspojne naprave:** Predspojna naprava konstatnog napona- naručiti zasebno. **Napajanje:** 24 V DC.



LineLed Flex

All flexible

Outdoor freak no matter the weather

LineLed Flex can follow all the lines and forms of architecture outdoor and indoor. It is a flexible silicone strip with a high IP rating, intended for creating decorative lighting scenes, sign lighting or simply to highlight all the forms, since it is easily bent in all directions. It emits uniform light with no shadows and is simple to install. And if you love playful coloured light, an RGB option is available.

Rad je na prostem ne glede na vreme

Svetilka LineLed Flex lahko sledi vsem linijam in oblikam arhitekture na prostem in v zaprtih prostorih. Je fleksibilen silikonski trak z visoko stopnjo zaščite IP, namenjen ustvarjanju dekorativnih svetlobnih scen, označevalni osvetlitvi ali poudarjanju vseh oblik, saj se zlahka upogiba v vse smeri. Oddaja enakomerno svetlobo brez senc in ga je preprosto namestiti. Če vam je všeč igriva barvna svetloba, je na voljo tudi RGB.

Uživa na otvorenom bez obzira na vrijeme

LineLed Flex može pratiti sve arhitekturne linije i oblike u otvorenom i u zatvorenom prostoru. To je fleksibilna silikonska traka s visokom IP ocjenom, namijenjena za kreiranje dekorativnih svjetlosnih scena, rasvjete reklamnih natpisa ili jednostavno za isticanje svih oblika jer se lako savija u svim smjerovima. Emitira jednolično svjetlo bez sjena i jednostavno je za instalaciju, a ako volite razigrano svjetlo u boji, dostupna je i RGB opcija.





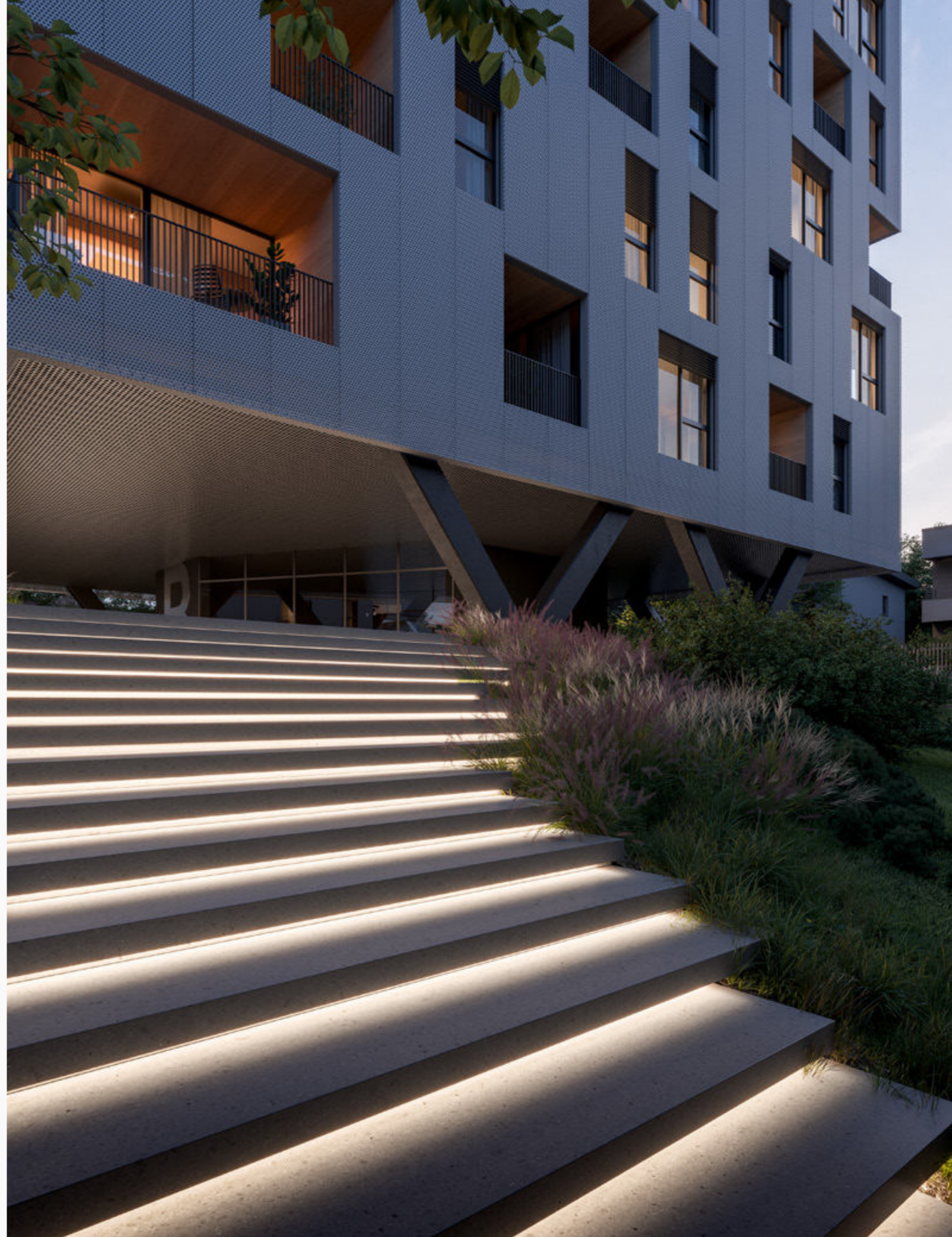

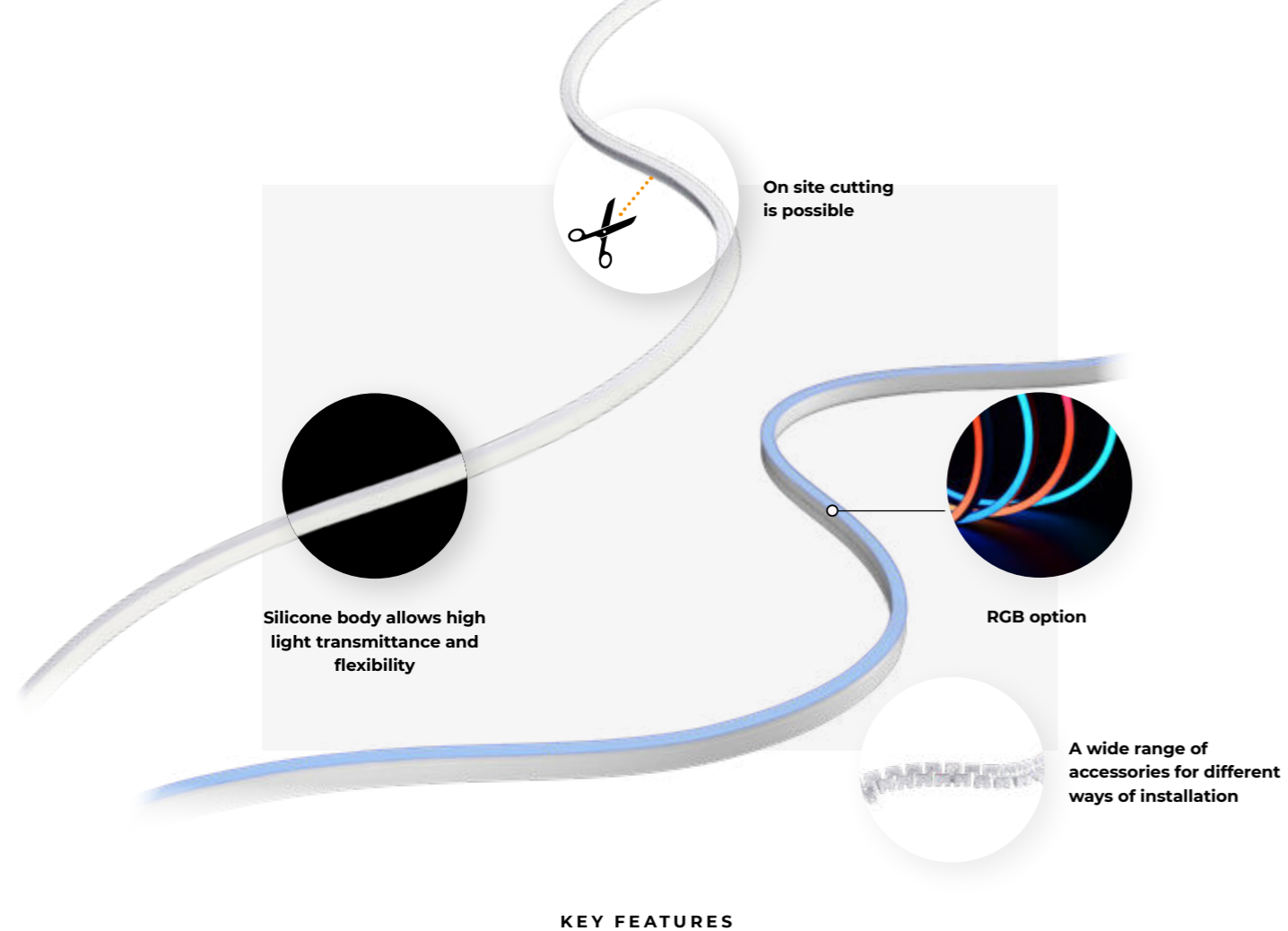

KEY FEATURES

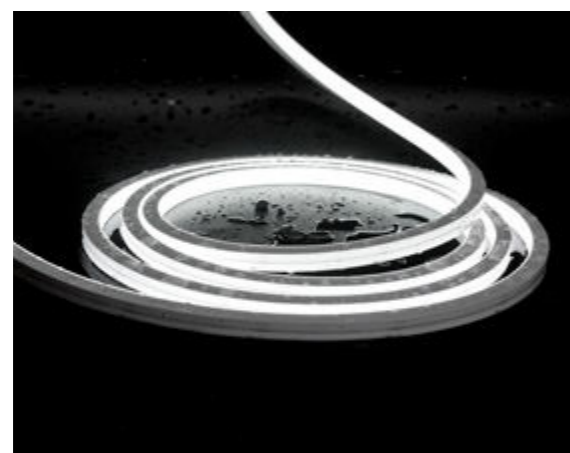

Weather-resistant

LineLed Flex is primarily made for the outdoors. With IP67, it is resistant to harsh environmental and weather conditions such as rain, sun and wind. It's flexible to follow straight and flexible shapes in the environment.



Create thin, only 4 mm light drawings

One of the thinnest light lines allows you to underline furniture and create stunning light effects.

LineLed Flex

Technical Overview



	FLEX LR 0410 Curved left / right, 4mm	FLEX UD 1312 Curved up / dawn, 13 mm	FLEX LR 1217 Curved left / right, 12 mm
Luminaire luminous flux/m	240 lm/m	670 lm/m	520 lm/m
LED colour	923, 930, 940	830, 840, RGBW	830, 840, RGBW
Driver	DALI, FO	DALI, FO	DALI, FO
Driver position	Remote	Remote	Remote
IP protection	IP65 (Indoor use only)	IP67	IP67
Material	Silicone	Silicone	Silicone
Flexibility	Horizontal	Vertical	Horizontal
Colour	1	1	1
Dimensions	L (mm): 5.000	L (mm): 10.000 / 5.000 (RGBW)	L (mm): 10.000 / 5.000 (RGBW)

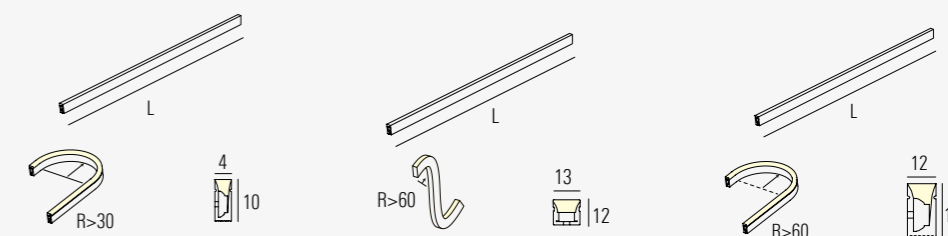

Accessories

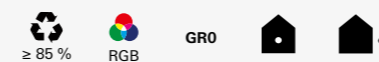
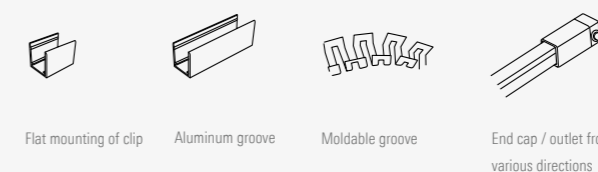

Light source: High-flux LED strip, CRI>80/90, MacAdam≤2, 50000h L80 B10 at 35°C. **Body:** Flexible silicone LED tube with IP65/67 rating and saline/acid/UV protection. **Control gear:** Constant voltage driver - order separately. **Power supply:** 24V DC.

Svetlobni vir: Visoko svetilen LED trak, CRI>80/90, barvno odstopanje MacAdam≤2, 50.000 h L80 B10 na 35 °C. **Ohišje:** Fleksibilna silikonska cev v zaščiti IP65/67. Odporna na soli, kisline in UV žarke. **Napajalnik:** LED konverter s konstantno napetostjo - ločeno naročanje. **Napajanje:** 24 V DC.

Izvor svetla: LED traka velikog svetlosnog toka, CRI>80/90, MacAdam≤2, 50000 h L80 B10 na 35 °C. **Kućište:** Fleksibilna silikonska LED cijev s IP65/67 zaštitom, otporna na utjecaj soli/kiselina i UV zraka. **Predspojne naprave:** Predspojna naprava konstatnog napona - naručiti zasebno. **Napajanje:** 24 V DC.



LineLED

Behind the scenes

It is the light and the effect that counts

With its compact size and various mounting possibilities, it's easy to integrate it under shelves, show-cases, but also wardrobes or cascades.

The illuminated object takes centre stage, while the luminaire steps into the background, emphasising the real value from behind the scenes.

Štejeta le svetloba in njen učinek

Zaradi kompaktnih dimenzij in različnih možnosti montaže lahko to svetilo zlahka umestite pod police, v razstavne vitrine, pa tudi v garderobe ali kaskade.

Osvetljeni objekt stopi v ospredje, svetloba pa ostaja v ozadju in iz zakulisja poudarja pravo vrednost.

Svetlo i učinak su ono što se broji

Svojom kompaktnom veličinom i raznim mogućnostima montiranja, lako se integrira ispod polica, ukrasnih ormara, ali i garderobe ili kaskada.

Osvjetljeni predmet zauzima središnji položaj, dok je rasvjeta u pozadini, naglašavajući stvarnu vrijednost iza prizora.



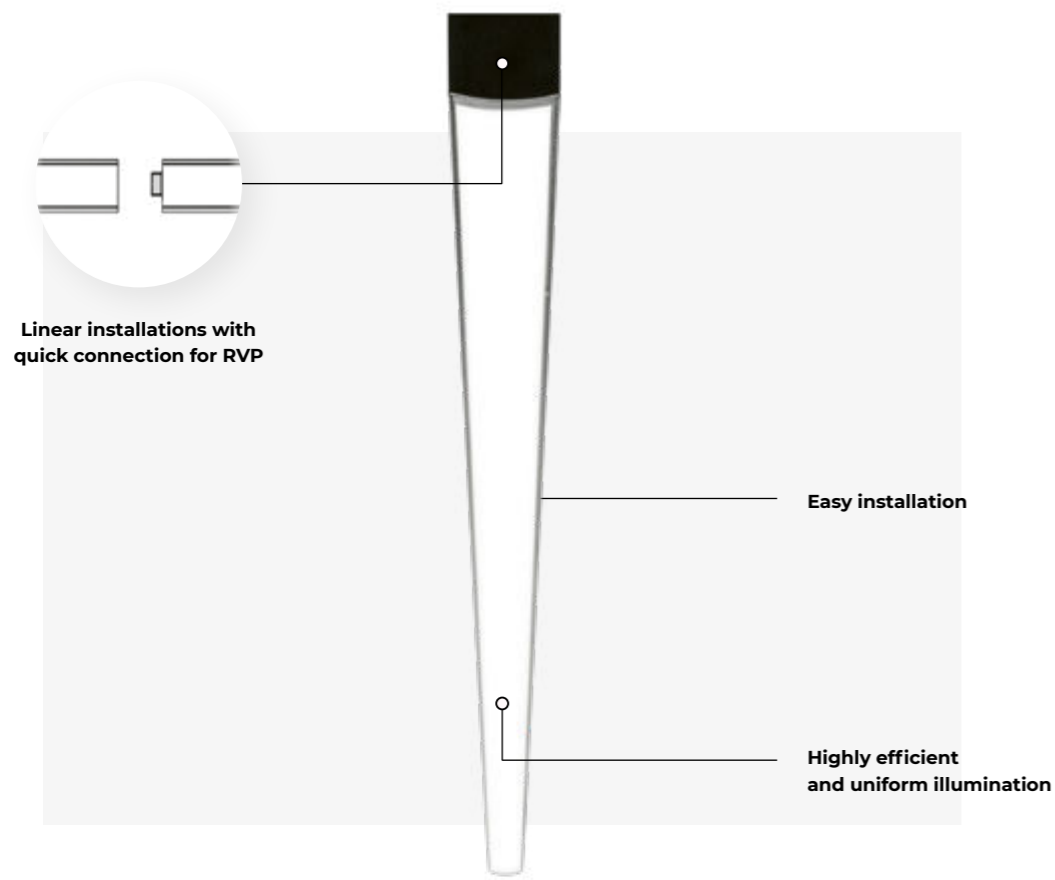

MAIN FEATURES

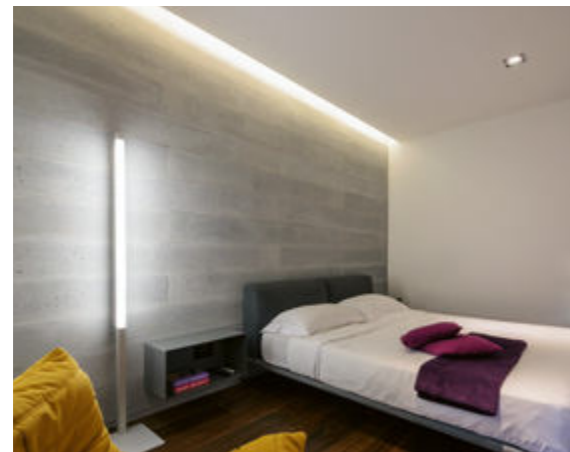

Cascades

Brings out colour and creates contrast in the ambient. With its compact size and various mounting possibilities, it's easy to integrate it under shelves, showcases, but also wardrobes or cascades.

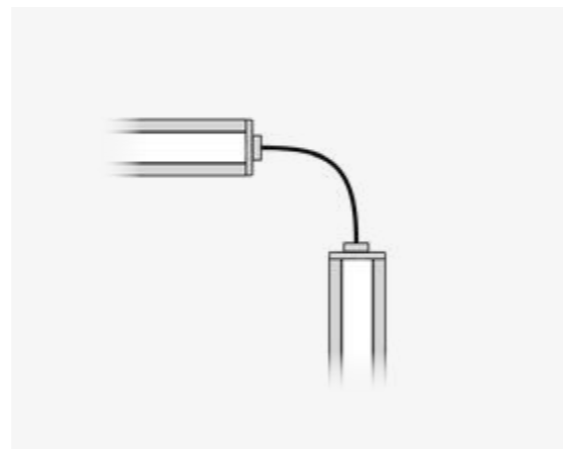

Flexible compositions for RVP

For all creative compositions with corner installations or other shapes, a line connector with wire (5 cm) is available.

LineLED

Technical Overview

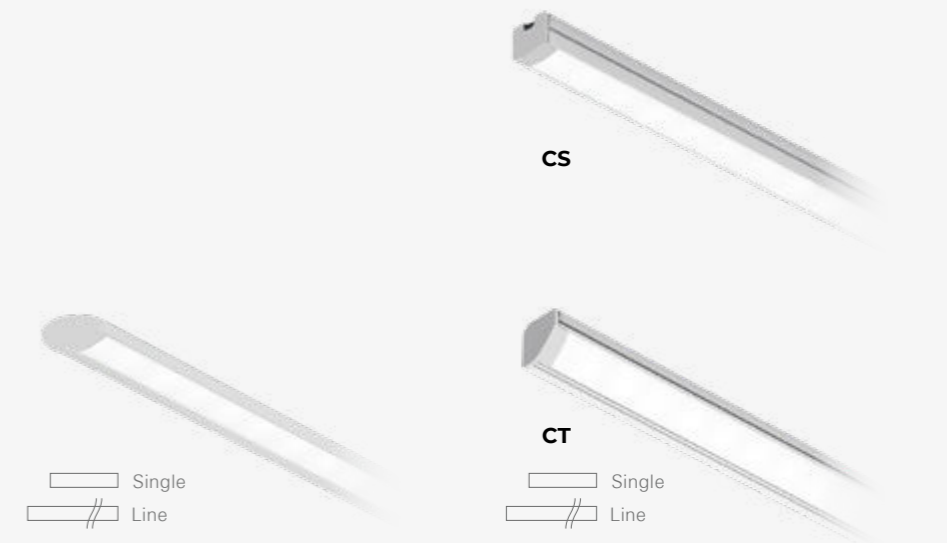

	RVW Recessed for wood	CS/CT Ceiling
Luminaire luminous flux/m	380-800 lm/m	380-800 lm/m
Optics	SOP	SOP
LED colour	930, 940	930, 940
Driver	Casambi, DALI, FO	Casambi, DALI, FO
Driver position	Remote	Remote
Colour	1 2	1 2
Dimensions	L (mm): 542 - 2542	L (mm): 517 - 2517

* For Line versions the LED strip and profile must be ordered separately.

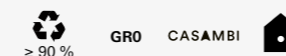

Light source: High-flux LED strip, CRI>90, MacAdam≤2, 50000h L90 B10 at 35°C. **Optic:** Satin opal polycarbonate diffuser (SOP). **Body:** Extruded aluminium profile, powder coated. **Control gear:** Constant voltage driver - order separately. **Power supply:** 24V DC.

Svetlobni vir: Visoko svetilen LED trak, CRI>90, barvno odstopanje MacAdam≤2, 50000 h L90 B10 na 35 °C. **Optika:** Satinirani opalni polikarbonatni difuzor (SOP). **Ohišje:** Ekstrudiran profil iz aluminija, prašno barvan. **Napajalnik:** LED konverter s konstantno napetostjo - ločeno naročanje. **Napajanje:** 24 V DC.

Izvor svetla: LED traka velikog svetlosnog toka, CRI>90, MacAdam≤2, 50.000 h L90 B10 na 35 °C. **Optika:** Satinirani opalni polikarbonatni difuzor (SOP). **Kućište:** Ekstrudirani aluminijski profil, elektrostat-ski plastificiran. **Predspojne naprave:** Predspojna naprava konstatnog napona- naručiti zasebno. **Napajanje:** 24 V DC.



Flea & Fyo

Less is more

There are some spaces that don't need much light, just a feeling of light being there

Both Flea and Fyo represent a low light level range that has many application possibilities. They are perfect when you want to create an intimate atmosphere and give preference to the feeling of sensation over brightness. Choose Fyo and Flea for wellness centres, night illumination, staircase illumination or accents on shelves.

Nekateri prostori ne potrebujejo veliko svetlobe, temveč le občutek, da je

Tako Flea kot Fyo sodita med svetila z nizko svetilnostjo, ki imajo veliko možnosti uporabe. Kot nalašč sta, ko želite ustvariti intimno vzdušje in dati prednost vzdušju pred razsvetljenostjo. Izberite svetilki Fyo in Flea za centre dobrega počutja, nočno osvetlitev, osvetlitev stopnišč ali poudarke na policah.

Postoje neki prostori kojima nije potrebno puno svjetla, već samo osjećaj osvjetljenosti

I Flea i Fyo predstavljaju raspon niske razine osvjetljenja koji ima mnogo mogućih primjena. Savršeni su kada želite stvoriti intimnu atmosferu, dajući prednost posebnom osjećaju nad osvjetljenošću. Odaberite Fyo i Flea za wellness centre, noćnu rasvjetu, osvijetljenje stubišta ili rasvjetu polica.





MAIN FEATURES

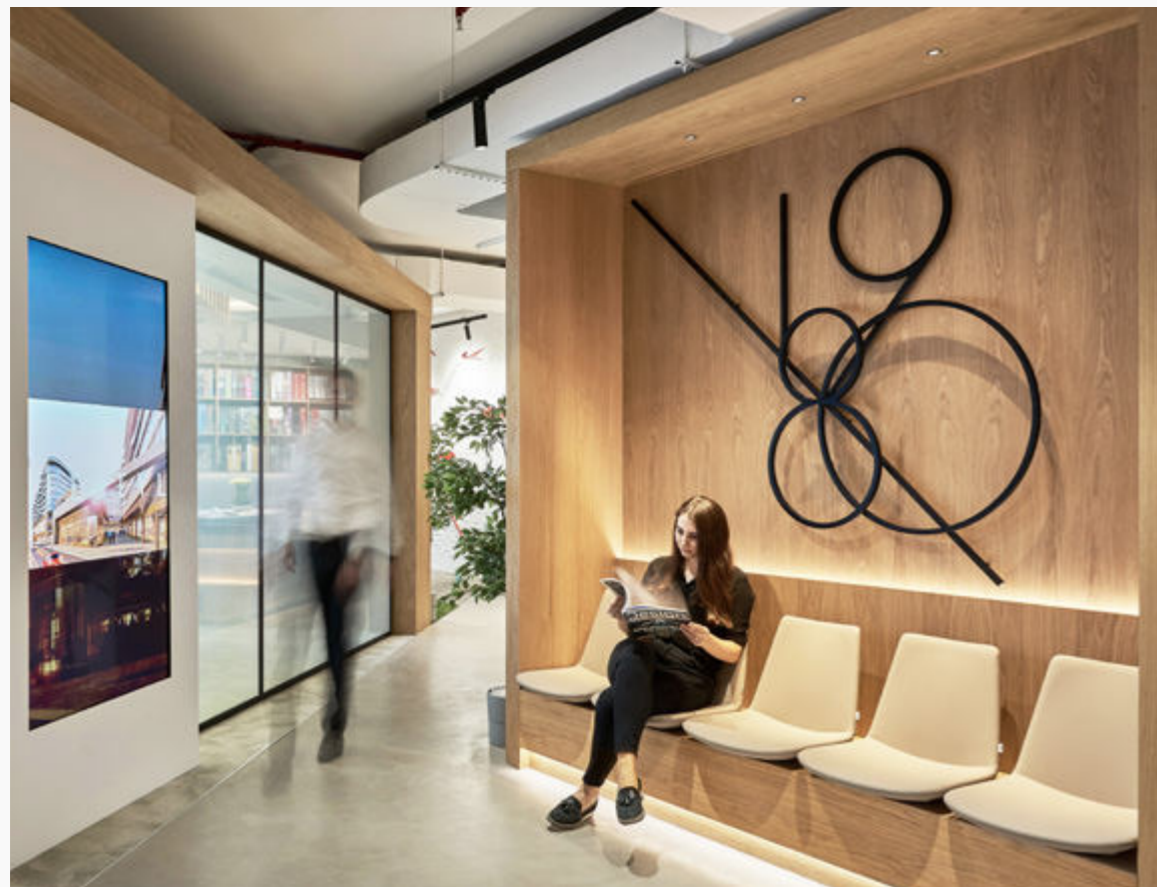

Accent on shelves

Make the products stand out. Flea can be easily integrated in the shelves.

Easily orientable

If you need to change the orientation, you shouldn't worry about that with Flea, as you can orient it the way you want.



Flea & Fyo

Technical Overview



Flea RVS 39 F



Flea RVW 39 F



Flea RV 39 F



Flea RVT 39 F



Flea RVP 39 F



Flea RVP 50 A



Flea L 39



Flea RVT 50 A



Fyo RV



Fyo C

FLEA

Fixed

Beam angle	15°, 30°, 15x45°, 95° (RVW)
Orientation	-
Luminaire luminous flux	Up to 230 lm
LED colour	827, 830, 840, 850
Driver	Casambi, DALI, FO
Driver position	Remote
IP protection	IP44*, IP20 (RVW)

Colour 1 2 3

FLEA

Orientable

Beam angle	15°, 30°, 15x45°
Orientation	± 30° / 360°
Luminaire luminous flux	Up to 220 lm
LED colour	827, 830, 840, 850
Driver	Casambi, DALI, FO
Driver position	Remote
IP protection	IP40

Colour 1 2 3

FLEA

Decorative

Beam angle	-
Orientation	-
Luminaire luminous flux	Up to 100 lm
LED colour	827, 830, 840, 850
Driver	Casambi, DALI, FO
Driver position	Remote
IP protection	IP40

Colour 1 2 3

FYO

RV / C

Beam angle	15°, 30°
Orientation	± 30° / 360°
Luminaire luminous flux	Up to 220 lm
LED colour	827, 830, 840, 850
Driver	Casambi, DALI, FO
Driver position	Remote
IP protection	IP43

Colour 1 2 3

Dimensions

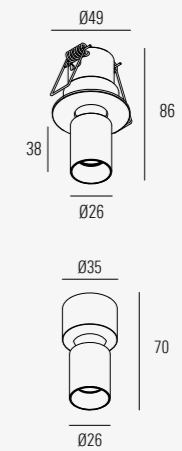
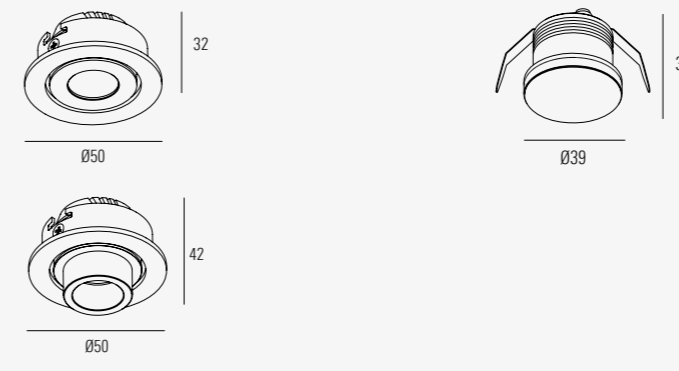
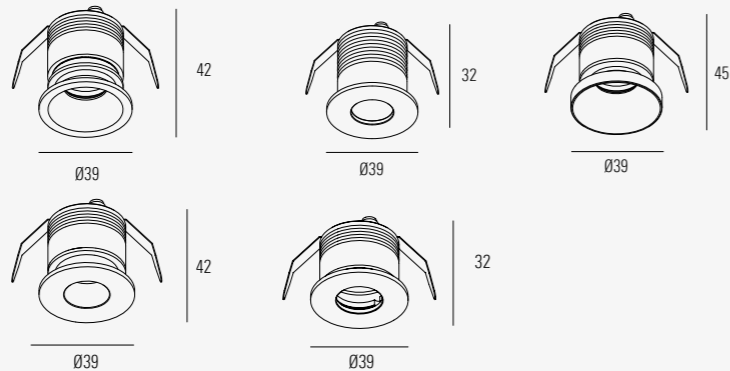

*IP value from the exposed side

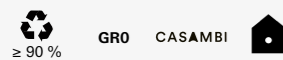

Light source: High-power LED, CRI>80, MacAdam \leq 2, 50.000h L80 B10 at 35°C.
Optic: Highly efficient PMMA optical lenses 15°, 15-45°, 30°, 95°. **Body:** Aluminium, powder coated. **Control gear:** Constant current driver - order separately. **Power supply:** 700mA.

Svetlobni vir: Visoko učinkovit LED modul, CRI>80, barvno odstopanje MacAdam \leq 2, 50.000 h L80 B10 na 35 °C. **Optika:** Visoko učinkovite PMMA optične leče (ozek, srednji, eliptični svetlobni snop) 15°, 15-45°, 30°, 95°. **Ohišje:** Aluminij, prašno barvan. **Napajalnik:** LED konverter s konstantnim tokom - ločeno naročanje. **Napajanje:** 700 mA.

Izvor svetla: LED velike snage, CRI>80, MacAdam \leq 2, 50.000 h L80 B10 na 35 °C. **Optika:** Visoko učinkovite PMMA leče (spot, srednja, eliptična) 15°, 15-45°, 30°, 95°. **Kućište:** Aluminijsko, elektrostatski plastificirano. **Predspojne naprave:** Predspojna naprava konstantne struje - naručiti zasebno. **Napajanje:** 700 mA.



Atos

A mighty mite

Residential and hospitality spaces just call for a spotlight like Atos

Atos is small but powerful. Due to its highly efficient reflector, it boasts impressive light quality, providing pleasant accent illumination with low glare. The spot is available in different colours and versions to easily fit into any space.

Stanovanja in hoteli prav kličejo po reflektorjih, kakršen je Atos

Atos je majhna, a močna svetilka. Zaradi zelo učinkovitega reflektorja se ponaša z neverjetno kakovostjo svetlobe, ki zagotavlja prijetno poudarjeno osvetlitev. Svetilka je na voljo v različnih barvah in različicah, da se zlahka ujema z vsakim prostorom.

Stambeni i ugostiteljski prostori žude za reflektorom poput Atosa

Atos je malen, ali močan. Zbog svog vrlo učinkovitog reflektora, može se pohvaliti impresivnom kvalitetom svjetla koje pruža ugodno naglašeno osvjetljenje. Reflektor je dostupan u različitim bojama i verzijama kako bi se lako uklopio u svaki prostor.





MAIN FEATURES



Surprisingly powerful

The power it has, despite its small size, is extraordinary. Due to the COB technology it can reach up to 600 lm. A wide range of rings is available and also a version with IP44 for rooms with higher moisture.

A more pleasant illumination with Atos RVT

The light source is deeply recessed and completely hidden. This prevents the direct eye contact and ensures a more pleasant illumination and higher visual comfort.



Atos

Technical Overview



Atos RVS 42 F



Atos RV 42 F



Atos RVP 42 F



Atos RVT 42 F



Atos RVO Zoom (45)



Atos RVO (26, 32, 45)



Atos RIQ



Atos RVQ



	RV	RVO	CL	RIQ / RVQ	INSETS KRI / KCS
	Recessed fixed / various rings / regressed optics	Semi-recessed orientable / regressed optics	Surface mounted orientable / regressed optics	Recessed double spot orientable / regressed optics	Atos insets for Kalis RI, RV, CS, SDI
Beam angle	20°, 30°, 55°	D 26: 18°/25°; D 32: 20°/30°/50°; D 45: 30°/59°/28°-45°	20°, 30°, 50°	D 32: 20°/30°/50°; D 45: 30°/59°/28°-45°	20°
Orientation	-	± 54° / 360°	± 54° / 360°	± 54° / 360°	-
Luminaire luminous flux	Up to 570 lm	Up to 590 lm	Up to 590 lm/spot	Up to 590 lm/spot	458 - 555 lm
LED colour	927, 930, 935, 940	927, 930, 935, 940	927, 930, 935, 940	927, 930, 935, 940	927, 930, 935, 940
Driver	Casambi, DALI, FO	Casambi, DALI, FO	Casambi, DALI, FO	Casambi, DALI, FO	Casambi, DALI, FO
Driver position	Remote	Remote	Integrated	Remote	Remote
IP protection	IP20, IP44*	IP20	IP20	IP20	IP20
Colour	1 2 3	1 2 3	1 2 3	1 2 3	1 2 3

Dimensions

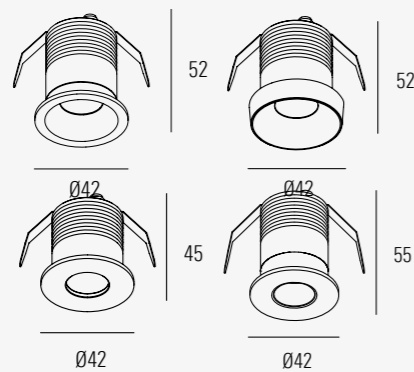

D x H (mm): 26x66, 32x77, 45x112

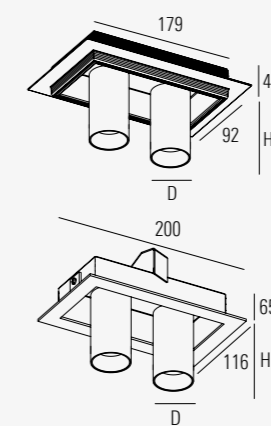
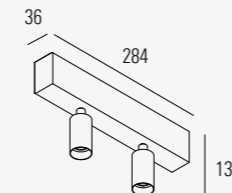

D x H (mm): 32x77, 45x112

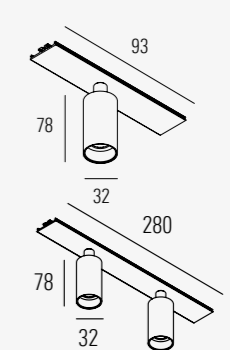

*IP value from the exposed side



Light source: High-power COB LED, CRI>90, MacAdam≤2, 50.000h L90 B10 at 35°C. **Optic:** Highly efficient with uniform distribution, metalized polycarbonate with lacquer finish. **Body:** Aluminium, powder coated. **Control gear:** Constant current driver - order separately. **Power supply:** 125 - 500mA.

Svetlobni vir: Visoko učinkovit COB LED modul, CRI>90, barvno odstopanje MacAdam≤2, 50.000 h L90 B10 na 35 °C. **Optika:** Visoko učinkovit metaliziran in lakiran polikarbonat z enakomerno porazdelitvijo svetlobnega snopa. **Ohišje:** Aluminij, prašno barvan. **Napajalnik:** LED konverter s konstantnim tokom - ločeno naročanje. **Napajanje:** 125 - 500 mA.

Izvor svetla: LED COB velike snage, CRI>90, MacAdam≤2, 50.000 h L90 B10 na 35 °C. **Optika:** Visoko učinkovit s jednolikom distribucijom, metaliziran polikarbonat sa završnim slojem laka. **Kućište:** Aluminijsko, elektrostatski plastificirano. **Predspojne naprave:** Predspojna naprava konstantne struje - naručiti zasebno. **Napajanje:** 125 - 500 mA.



Liy

Maximally minimal

Pure light effect

Liy is perfect for elegant spaces where you just can't have an ordinary spot. Its main advantage is the appearance of pure light without any source glare. It is minimalistic. Imagine, the opening on the bottom of the funnel is only 8 mm wide. Then, it depends on the housing colour whether you want the whole luminaire to stand out or to completely blend in.

Liy can perform as a single spot, in a pair, or in a row of three, four or more. It can be fixed or flexible, allowing to change the beam angle and orientation, always having visual attention on the object.

Čisti svetlobni učinek

Liy je kot nalašč za elegantne prostore, v katerih navadnega reflektorja preprosto ne morete imeti. Njegova glavna prednost je čista svetloba brez bleščanja svetlobnega vira. Je minimalistična. Predstavljajte si, da je odprtina na dnu lijaka široka le 8 mm. Od barve ohišja je odvisno, ali želite, da celotna svetilka izstopa ali se popolnoma neopazno zlije s stropom.

Liy lahko prostor osvetljuje samostojno, v paru ali v vrsti treh, štirih ali več reflektorjev. Lahko je fiksna ali fleksibilna, kar omogoča spreminjanje kota in usmerjenosti žarka ter ohranja vizualno pozornost na predmetu.

Čisti svetlosni efekt

Liy je savršen za elegantne prostore u kojima jednostavno ne možete imati obično stropno svjetlo. Njegova glavna prednost je izgled čiste svjetlosti bez bliještanja. Minimalističkog je dizajna. Otvor na dnu sjenila širok je nevjerojatnih 8 mm, a boju kućišta odaberite ovisno o tome želite li da se cijela svjetiljka istakne ili da se potpuno utopi u prostor.

Liy može funkcionirati kao pojedinačno stropno svjetlo, u paru ili u nizu od tri, četiri ili više. Može biti fiksirano ili fleksibilno, što omogućuje promjenu kuta i orijentacije svjetlosnih snopova uvijek pružajući vizualni fokus na objekt.



The product has a custom colour.





Watch video



MAIN FEATURES



Double rotation and clean looks

With a simple gesture you can change both, the direction and the inclination angle of the light. In a row of spotlights, you can set each spot individually. And then change it when needed.

Trim-less installation

For a precise and clean trim-less installation of two or three spots in a row, you can use the installation kit. In this case the "only light" effect is even greater.



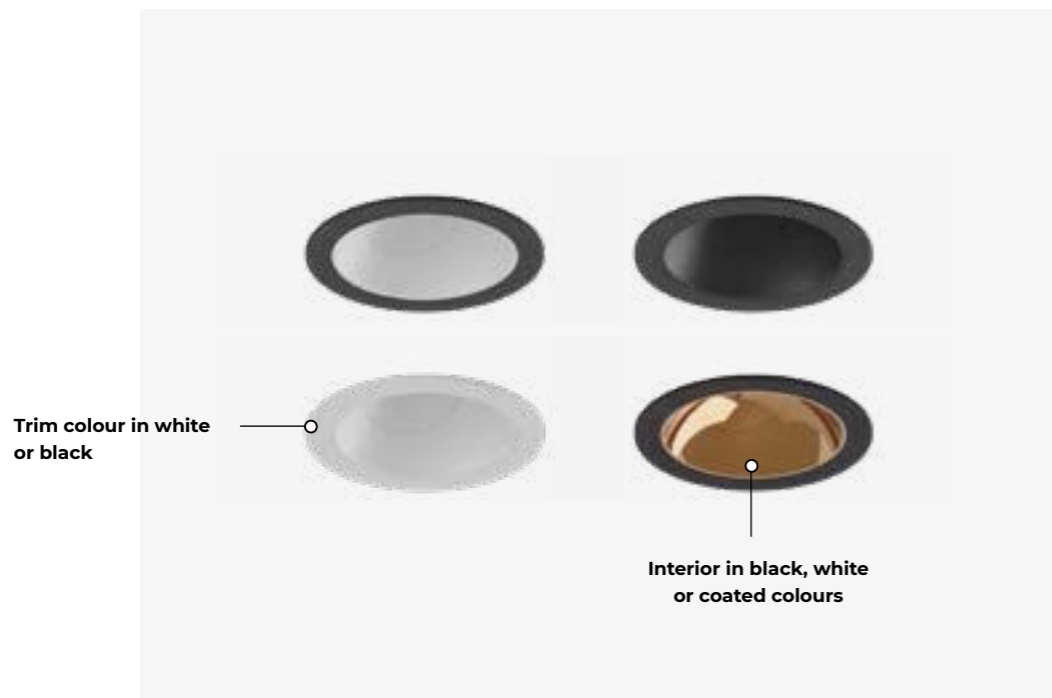

OPTICS

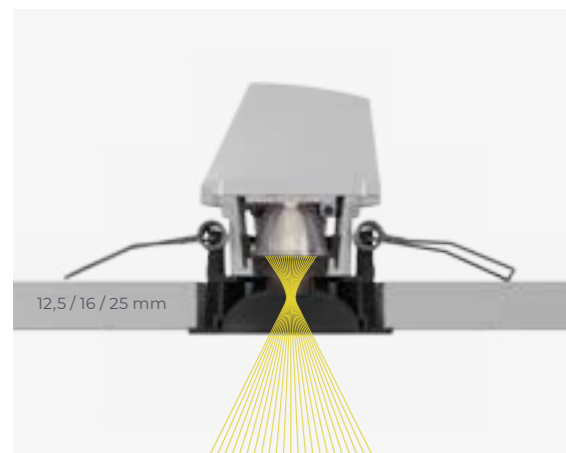

LFO - A guarantee of maximum visual comfort

Due to special design of Bartenbach LFO optic, all you can see is pure light. The light source is hidden deep inside the optics offering high visual comfort.

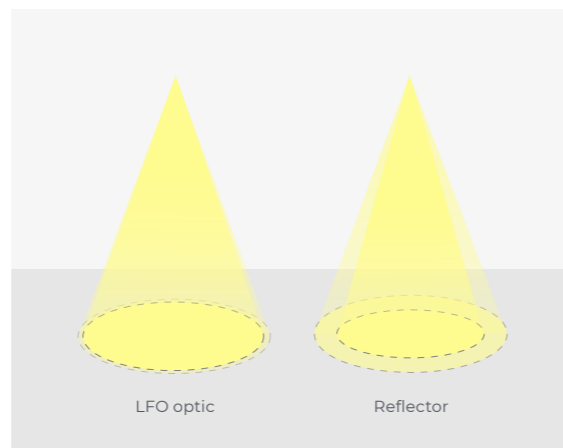

No double ring

With the Bartenbach LFO optic the light circle is well-defined and homogeneous. At the limits the light intensity is still high.

Liy

Technical Overview



RI
Recessed trim-less



RV
Recessed visible trim

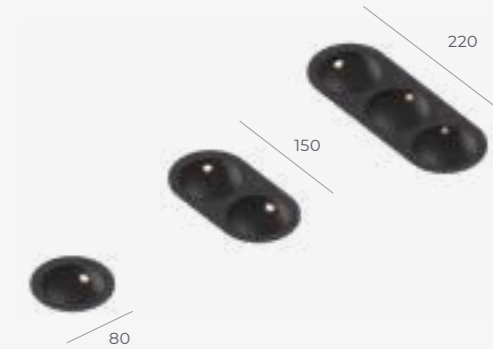

F
Fixed

A
Adjustable

Beam angle	LFO 33°, 50°	LFO 33°, 50°
Orientation	-	25° / 360°
Luminaire luminous flux*	up to 190 lm / spot	up to 190 lm / spot
LED colour	927, 930, 935, 940	927, 930, 935, 940
Driver	Casambi, DALI, FO	Casambi, DALI, FO
Driver position	Remote	Remote
IP protection**	IP44	IP44
Funnel colour	2 H F Y	1 2 H F Y
Frame colour	2	1 2

Dimensions

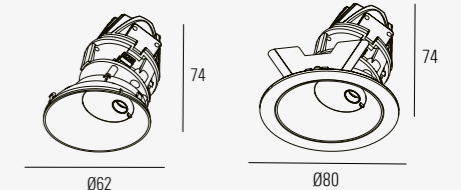

* The data refer to one spot. Multiply the number with the number of spots. ** IP value from the exposed side

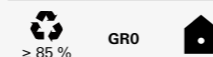

Light source: High-power LED, CRI>90, MacAdams≤2,5, 50.000h L80 B10 at 35°C. **Optic:** Acrylic glare-free LFO lens. **Body:** Polycarbonate. Optional with metalized coating. **Control gear:** Constant current driver - order separately. **Power supply:** 500 - 800 mA.

Svetlobni vir: Visoko učinkovit COB LED modul, CRI>90, barvno odstopanje MacAdams≤2,5, 50.000h L80 B10 na 35°C. **Optika:** Akrilna LFO leča brez bleščanja. **Ohišje:** Polikarbonat. Opcijsko z metalizirano prevleko. **Napajalnik:** LED konverter s konstantnim tokom - ločeno naročanje. **Napajanje:** 500 - 800 mA.

Izvor svetla: LED COB velike snage, CRI>90, MacAdams≤2,5, 50.000h L80 B10 at 35°C. **Optika:** LFO akrilna leča bez bliještanja. **Kućište:** Polikarbonatno. Opcija - metalizirani završni sloj **Predspojne naprave:** Predspojna naprava konstantne struje - naručiti zasebno. **Napajanje:** 500 - 800 mA.

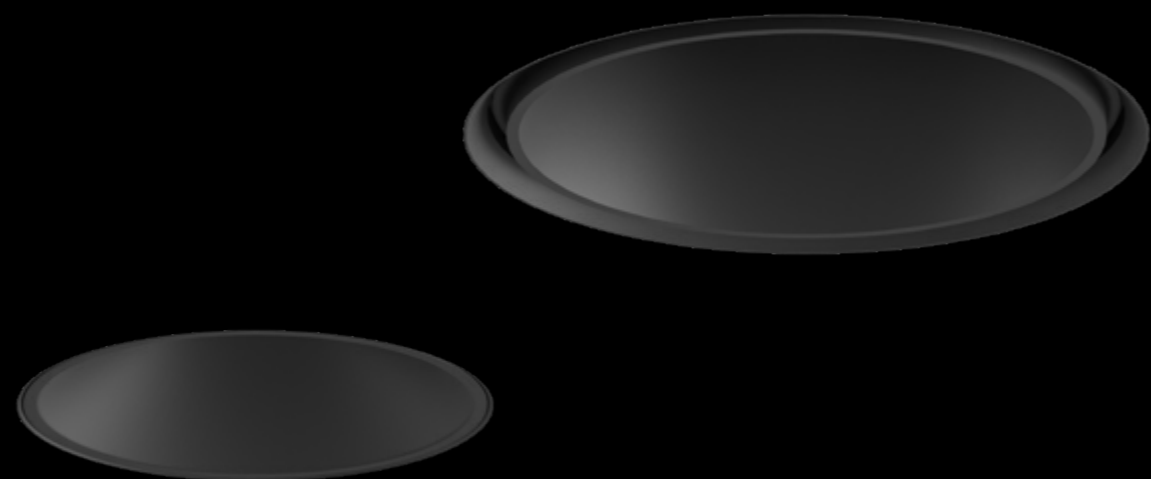

Conic

An iconic spot

No need to putty at all

When you want a spot on a higher level, choose Conic. It's distinguished by prestigious finishes, wide range of colours and clean looks.

Most of all, Conic stands out for its innovative, easy and clean installation in a finished plaster ceilings, with tools of standard sizes and no puttying.

Pozabite na kitanje

Ko želite reflektor višjega ranga, izberite Conic. Odlikuje ga prestižni premazi, široka paleta barv in čist videz.

Predvsem pa Conic izstopa po svoji inovativni, enostavni in čisti vgradnji v mavčne stropove z orodjem standardnih velikosti in brez izravnave površin s kitanjem.

Nije potrebno fiksiranje

Ako želite reflektor visoke kvalitete, odaberite Conic. Odlikuje se prestižnim završnim obradama, širokim rasponom boja i praktičnim izgledom.

Iznad svega, Conic se ističe inovativnom, jednostavnom i praktičnom ugradnjom u gotove gipsane stropove, alatima standardnih veličina i bez fiksiranja ljepljivom masom.



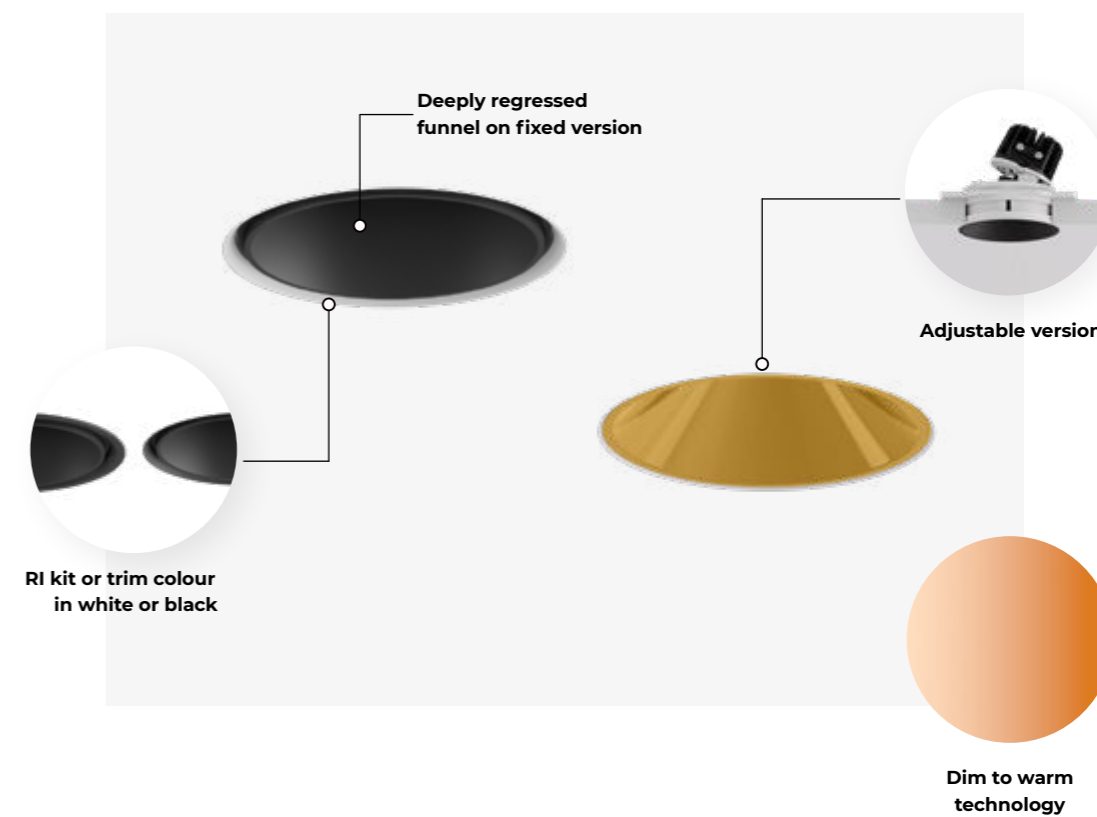

MAIN FEATURES



Prestigious look with trendy colours

The interior of the funnel can be gold, bronze or onyx coated which gives a luminaire prestigious look. Gold & bronze are on trend, but at the same time timeless chic finishes, perfect to match all kinds of interiors.

IP44

It's the perfect solution for high moisture environments like bathrooms. It offers pleasant and functional light as well as IP44 protection.

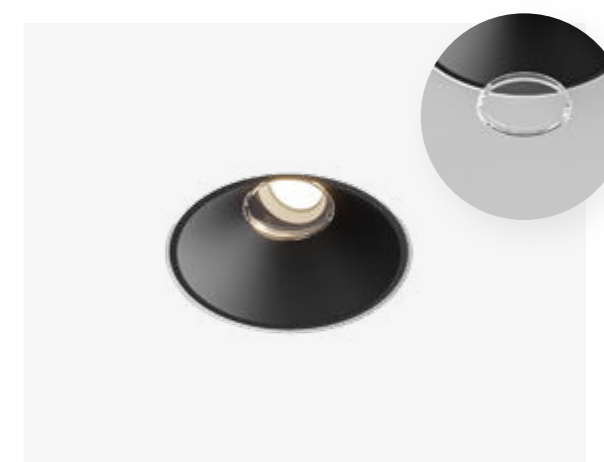

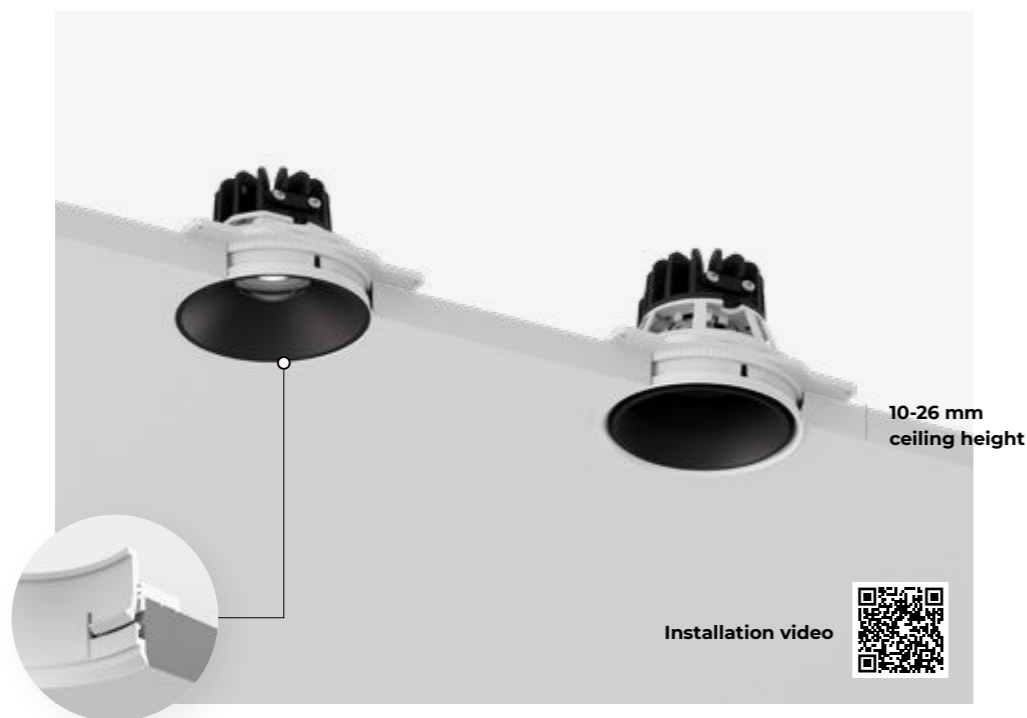

RI kit for installation without puttying

REVOLUTIONARY TRIM-LESS INSTALLATION



Make a hole with a standard 80 mm hole saw



Paint the ceiling, no puttying needed



Twist and level the RI kit with the ceiling



Click in the spot and the funnel

Conic

Technical Overview



ADJUSTABLE (A)



FIXED (F)



	RI Recessed trim-less	RV Recessed visible trim
Beam angle	20°, 30°, 55°	20°, 30°, 55°
Orientation	25° / 360° (A)	25° / 360° (A)
Luminaire luminous flux	540 - 970 lm	540 - 970 lm
LED colour	927, 930, 935, 940	927, 930, 935, 940
Dynamic light	Dim to warm (D2W)**	Dim to warm (D2W)**
Driver	Casambi, DALI, FO	Casambi, DALI, FO
Driver position	Remote	Remote
IP protection*	IP44	IP44
RI kit / Frame colour	1 2	1 2
Inner colour	1 2 H F Y	1 2 H F Y

Dimensions

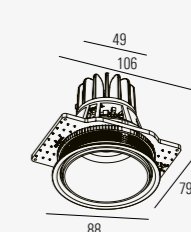
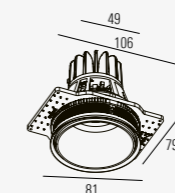
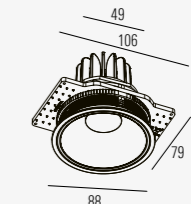
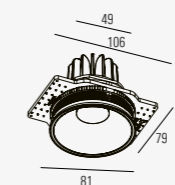

*IP value from the exposed side. **Dim to warm is possible on 55° beam angle.

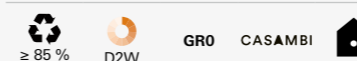

Light source: High-power COB LED, CRI>90, MacAdam≤2, 50.000h L90 B10 at 35°C. **Optic:** Highly efficient with uniform distribution, metalized polycarbonate with lacquer finish. **Body:** Polycarbonate. Optional with metalized coating. **Control gear:** Constant current driver - order separately. **Power supply:** 150 - 900 mA.

Svetlobni vir: Visoko učinkovit COB LED modul, CRI>90, barvno odstopanje MacAdam≤2, 50.000 h L90 B10 na 35 °C. **Optika:** Visoko učinkovit metaliziran in lakiran polikarbonat z enakomerno porazdelitvijo svetlobnega snopa. **Ohišje:** Polikarbonat. Opcijsko z metalizirano prevleko. **Napajalnik:** LED konverter s konstantnim tokom - ločeno naročanje. **Napajanje:** 150 - 900 mA.

Izvor svetla: LED COB velike snage, CRI>90, MacAdam≤2, 50.000 h L90 B10 na 35 °C. **Optika:** Visoko učinkovit s jednolikom distribucijom, metaliziran polikarbonat sa završnim slojem laka. **Kućište:** Polikarbonatno. Opcija - metalizirani završni sloj. **Predspojne naprave:** Predspojna naprava konstantne struje - naručiti zasebno. **Napajanje:** 150 - 900 mA.



Pipes R

Totally responsive

Focus as a matter of choice

A range of recessed LED spots brings efficiency and customization together. With a wide choice of colour combinations, power options and sizes, Pipes R is a spot that can blend in discretely or become an eye catching element in the space.

The concept of »Less is more« went beyond the design itself or the way a space is used. Each and every product component has been optimized to make the Pipes R highly efficient and affordable.

Fokus je zgolj stvar odločitve

Pipes R je družina vgradnih LED spotov, ki so zelo učinkoviti in prilagodljivi obnem. Zaradi velike izbire barvnih kombinacij, različnih moči in dimenzij se Pipes R lahko diskretno zlije s prostorom ali pa izstopi.

Koncept »manj je več« je presegel dizajn svetila in način uporabe prostora. Prav vsaka komponenta izdelka je bila optimizirana do te mere, da je Pipes R visoko učinkovito in hkrati dostopno svetilo.

Fokus kao stvar izbora

Raspon ugradnih LED reflektora Pipes R objedinjuje učinkovitost i prilagodbu. Sa svojim širokim izborom kombinacija boje, snage i dimenzija, Pipes R je reflektor koji se može diskretno uklopiti u prostor ili postati upravo akcent prostora.

Koncept »manje je više« je otišao dalje od samog dizajna ili načina korištenja prostora. Svaka komponenta proizvoda je optimizirana kako bi učinila Pipes R visoko učinkovitim i pristupačnim.

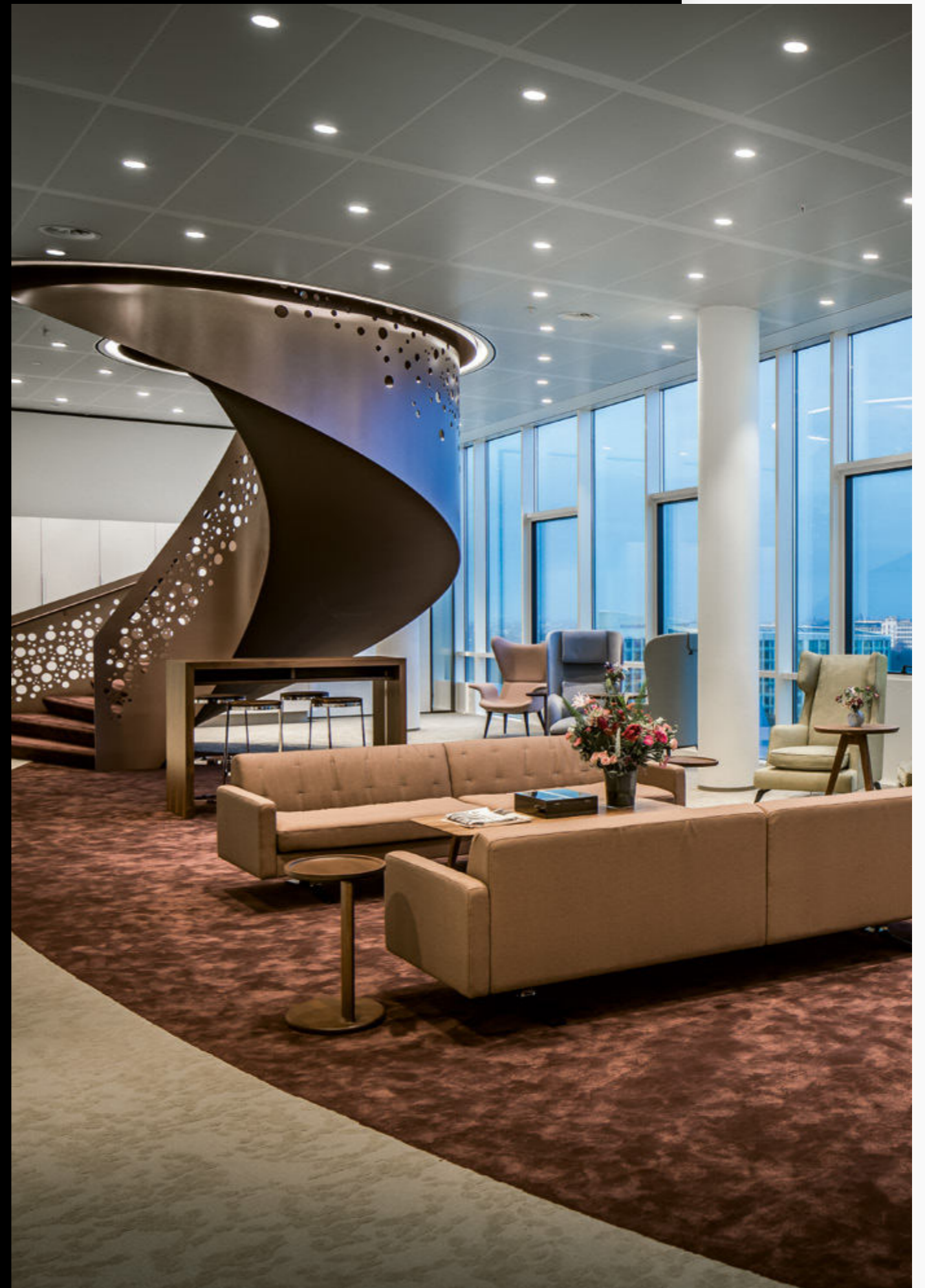







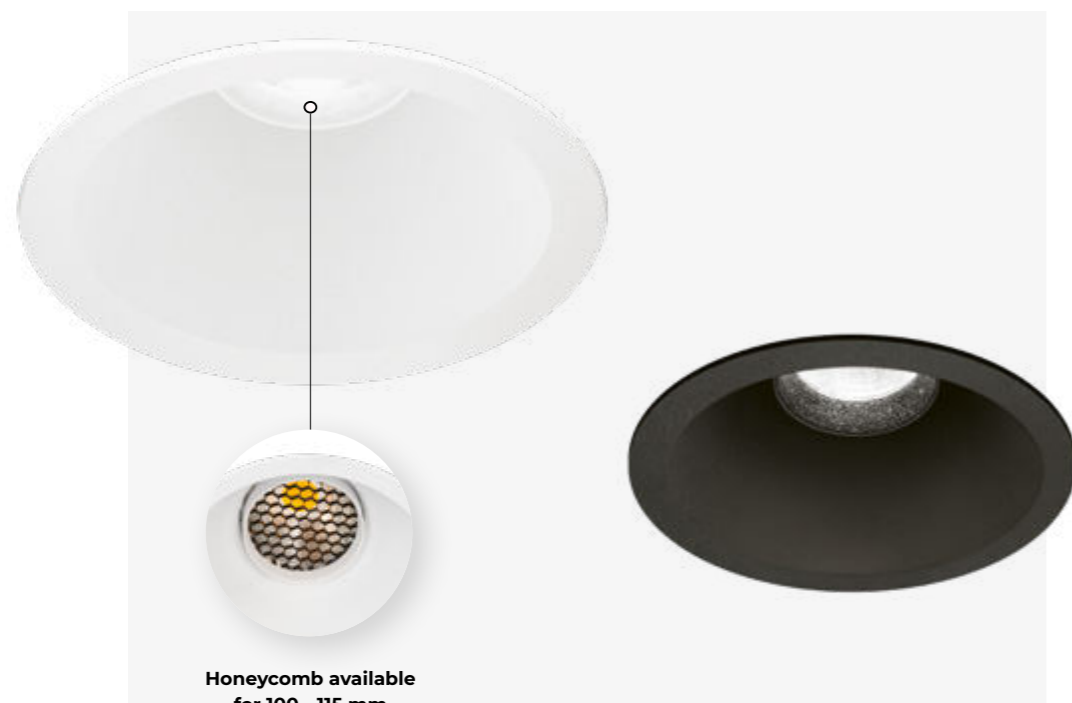

Honeycomb available for 100 - 115 mm

MAIN FEATURES



Dual colour

Play with the second colour to create a different look in your space. Decorative ring needs to be ordered separately and is available only for dimensions 60 and 105 mm on the RV models.



IP44

It's the perfect solution for high moisture environments like bathrooms. It offers pleasant and functional light as well as IP44 protection.



RI
Recessed trim-less



RV
Recessed visible trim



RVS
Recessed visible slim trim



RVSQ
Recessed visible trim square

Dynamic illumination



Tunable white technology
It allows you to get close to the dynamic of sunlight. You can set the colour temperature from cool to warm white upon your needs.

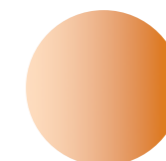

Dim to warm technology
Create a warm, soft, cosy and relaxing atmosphere. Like the one we achieved with the old light bulbs.

CRI for every occasion



CRI>90 improves the appearance of objects. It leads to a natural and fresh appearance that brings out colours, textures, and shapes. It is perfect for retail stores, shops, restaurants, museums and galleries.



CRI>80 is suitable for general indoor illumination: residential applications, offices, hotels, schools, gyms.

Vivid COB



Warm Crispy



Warm Vivid



Plant White



Fresh Rose



Alaska



Clear White

Pipes R

Technical Overview



RI Recessed trim-less



Ø 60, H 71 mm
Fixed

RV Recessed visible trim



Ø 60, H 70 / 103 mm
Fixed / Adjustable

RVS / RVSQ Recessed visible trim



Ø 65, H 69 / 102 mm
Fixed / Adjustable



Ø 80, H 82 mm
Fixed



Ø 80, H 82 / 115 mm
Fixed / Adjustable



Ø 89, H: 82 / 115 mm
Fixed / Adjustable



Ø 85, H 82 / 115 mm
RVSQ Fixed / Adjustable



Ø 100, H 116 / 126 mm
Fixed / Adjustable



Ø 105, H 133 mm
Adjustable



Ø 115, H 133 mm
Adjustable



Ø 133, H 175 mm
Fixed



Ø 140, H 189 mm
Adjustable

SPOT/SLOT



Ø 85, H 70 mm
RVS SPOT Fixed



Ø 85, H 105 mm
RVS SLOT Adjustable

	60-65 MM	85 MM	80-89 MM	100-115 MM	140 MM
Beam angle	20°, 30°, 55°	20°	20°, 30°, 55°	19°, 30°, 40°, 60°	15°, 24°, 30°, 40°, 56°, 62°
Orientation	25° (A) / 360°	25° (Slot) / 360°	25° (A) / 360°	±25° (A) / 360°	±25° (A) / 360°
Luminaire luminous flux	up to 1050 (20°, 30°), 1400 lm (55°)	up to 740 lm	up to 1050 (20°, 30°), 1400 lm (55°)	950 - 3400 lm	1300 - 6500 lm
LED colour	830, 840, 927, 930, 935, 940	830, 840, 927, 930, 935, 940	830, 840, 927, 930, 935, 940	830, 835, 840, 927, 930, 940	830, 835, 840, 927, 930, 940
Dynamic light	Dim to warm (D2W)	Dim to warm (D2W)	Dim to warm (D2W)	Tunable white 2700 - 6500K (TW)	Tunable white 2700 - 6500K (TW)
Special LED colour	-	-	-	Alaska, Clear white, Fresh rose, Warm crispy, Warm vivid, Plant white	Alaska, Clear white, Fresh rose, Warm crispy, Warm vivid, Plant white
Driver	Casambi, DALI, FO	Casambi, DALI, FO	Casambi, DALI, FO	Casambi, DALI, FO	Casambi, DALI, FO
Driver position	Remote	Remote	Remote	Remote	Remote
IP protection	IP20, IP44* (RV, RVS)	IP20	IP20	IP20, IP44* (RV)	IP20
Colour	1 2 3	1 2 3	1 2 3	1 2 3	1 2 3

*IP value from the exposed side



Light source: High-power COB LED, CRI>80/90, MacAdam≤2, 50.000h L90 B10 at 35°C. **Optic:** Highly efficient with uniform distribution, metalized polycarbonate with lacquer finish. **Body:** Polycarbonate. **Control gear:** Constant current driver order separately. **Power supply:** 150 - 1050mA.

Svetlobni vir: Visoko učinkovit COB LED modul, CRI>80/90, barvno odstopanje MacAdam≤2, 50.000 h L90 B10 na 35 °C. **Optika:** Visoko učinkovit metaliziran in lakiran polikarbonat z enakomerno porazdelitvijo svetlobnega snopa. **Ohišje:** Polikarbonat. **Napajalnik:** LED konverter s konstantnim tokom - ločeno naročanje. **Napajanje:** 150 - 1050 mA.

Izvor svjetla: LED COB velike snage, CRI 80/90, MacAdam≤2, 50.000 h L90 B10 na 35 °C. **Optika:** Visoko učinkovit s jednolikom distribucijom, metaliziran polikarbonat sa završnim slojem laka. **Kućište:** Polikarbonatno. **Predspojne naprave:** Predspojna naprava konstantne struje - naručiti zasebno. **Napajanje:** 150 - 1050 mA.



Rylo

Extraordinary light comfort

If you don't want to see where the light comes from, this is the solution

Rylo is not a common downlight. With its special optics it provides high visual comfort and generates circular light emission.

It doesn't show off. The light source is hidden and all you can see is pure light with absolutely no glare. It is universal, perfect for all spaces and projects.

Če ne želite videti, od kod prihaja svetloba, je to rešitev

Rylo ni običajen reflektor. S svojo posebno optiko zagotavlja veliko vizualno udobje in ustvarja krožno oddajanje svetlobe.

Se ne izpostavlja. Vir svetlobe je skrit in vse, kar lahko vidite, je čista svetloba popolnoma brez bleščanja. Je univerzalen, primeren za vse prostore in projekte.

Ako ne želite vidjeti odakle dolazi svjetlo, ovo je pravo rješenje

Rylo nije uobičajeno svjetlo. Svojom posebnom optikom postiže visoku vizualnu ugodu i stvara kružnu emisiju svjetlosti.

Rylo je diskretno svjetlo. Njegov izvor je skriven i sve što možete vidjeti je čista svjetlost bez apsolutno ikakvog odsjaja. Univerzalan je i savršen za sve prostore i projekte.





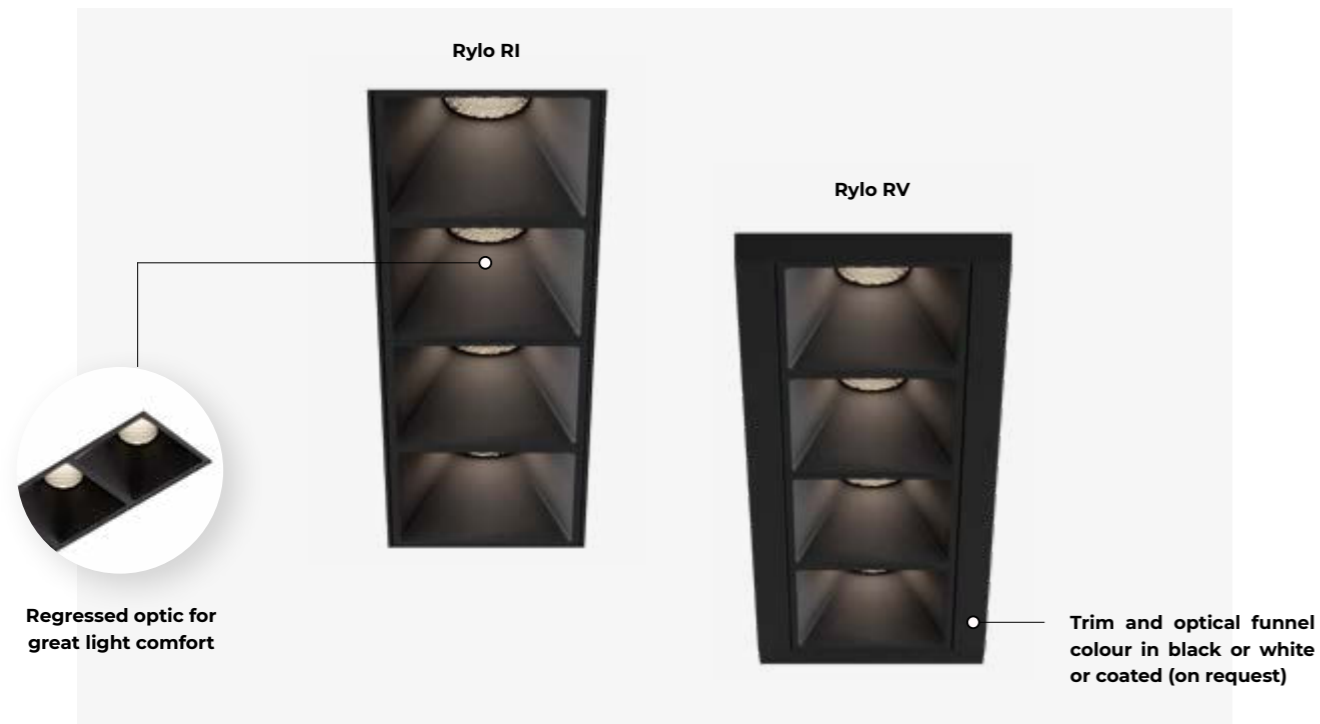

MAIN FEATURES

Wallwasher Rylo RV WW

Homogenous wall illumination with specific Bartenbach MDB-W wallwash optics.



Great light comfort

Create a healthier environment with lighting which importantly affects our well-being and mood. Rylo provides low glare and offers high light comfort.

Rylo

Technical Overview



RI
Recessed trim-less

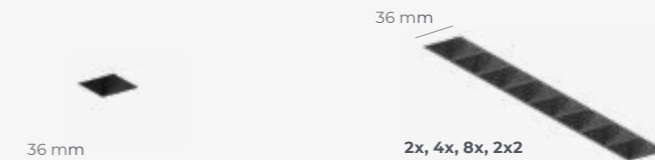

RV
Recessed visible trim

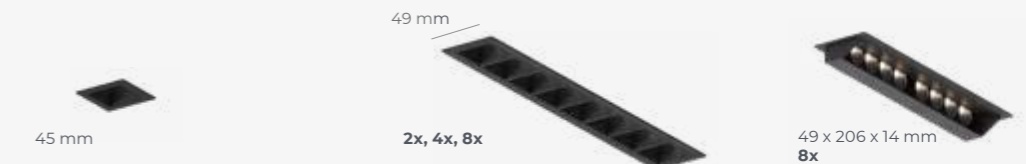

C
Ceiling

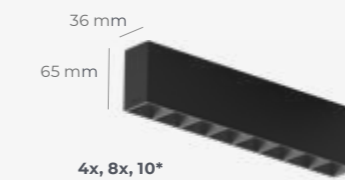

T
Track

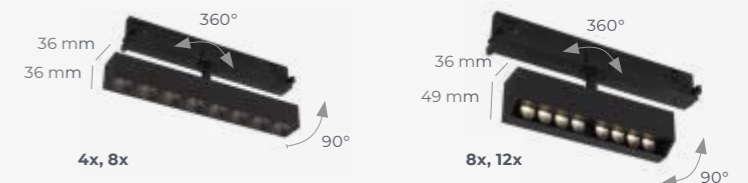

	MULTISPOT	MULTISPOT	WALLWASHER
Beam angle	22°, 30°, 50°, Asymetric	22°, 30°, 50°, Asymetric	Wallwasher
Luminaire luminous flux	up to 200 lm/spot	up to 160 lm/spot	394 - 1519 lm
Glare control	<19	<19	-
LED colour	927, 930, 935, 940	927, 930, 935, 940	927, 930, 940
Driver	Casambi, DALI, FO	Casambi, DALI, FO	Casambi, DALI, FO
Driver position	Remote	Remote / Integrated*	Remote / Integrated
Colour	1 2	1 2	1 2

* The driver is integrated only in the Rylo C 10x version.

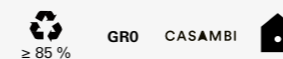

Light source: High-flux PCB LED modules, mid-power SMD LED, CRI>90, MacAdam≤2, 50.000h L90 B10 at 35°C. / High-power LED, CRI>90, MacAdam≤2,5, 50.000h L80 B10 at 35°C. **Optic:** Low glare spot optical system with UGR<19, wallwasher. **Body:** Extruded aluminium profile, powder coated. **Control gear:** Constant current driver - order separately. **Power supply:** 250-800 mA.

Svetlobni vir: High-flux PCB LED moduli, z SMD LED, CRI>90, MacAdam≤2, 50.000 h L90 B10 na 35 °C. / Visoko učinkovit COB LED modul, CRI>90, barvno odstopanje MacAdam≤2,5, 50.000 h L80 B10 na 35 °C. **Optika:** Reflektorski optični sistem z omejenim bleščanjem UGR<19, wallwasher. **Ohišje:** Ekstrudiran profil iz aluminija, prašno barvan. **Napajalnik:** LED konverter s konstantnim tokom - ločeno naročanje. **Napajanje:** 250-800 mA.

Izvor svetla: PCB LED moduli velikog svjetlosnog toka, SMD LED srednje snage, CRI>90, MacAdam≤2, 50.000 h L90 B10 at 35 °C. / LED COB velike snage, CRI>90, MacAdam≤2,5, 50.000 h L80 B10 at 35 °C. **Optika:** Reflektorski optički sistem s UGR<19, wallwasher. **Kućište:** Ekstrudirani aluminijски profil, elektrostatski plastificiran. **Predspojne naprave:** Predspojna naprava konstantne struje - naručiti zasebno. **Napajanje:** 250-800 mA.



Deux pièces

Simple and flexible

Less light, more impact

Deux pièces is unique, different in so many ways. This small luminaire is powerful enough to solve various illumination challenges and help you take your ideas even further.

Its famous award winning design fascinates with unexpected detail and fantastic colour reproduction. A wide family range allows satisfaction in different illumination needs without compromising on style. The impact is guaranteed.

Manj svetlobe, večji vtis

Deux pièces je edinstveno svetilo, drugačno v mnogih pogledih. Je majhno, a dovolj močno, da je lahko kos različnim izzivom osvetlitve in prav kliče po vedno novih zamislih.

Njegov sloviti in večkrat nagrajeni dizajn očara z nepričakovanimi detajli in vrhunsko barvno reprodukcijo. Široka družina svetil omogoča uspešne rešitve različnih potreb po osvetlitvi, brez kompromisov na račun sloga. Vtis je zagotovljen.

Manje svetla, više učinka

Deux pièces je jedinstven, različit na toliko načina. Ova je mala svjetiljka dovoljno snažna da riješi različite rasvjetne izazove i potakne još više širenje ideja.

Njegov nagrađivani dizajn zadivljuje neočekivanim detaljem i fantastičnom reprodukcijom boje. Široki raspon obitelji omogućuje zadovoljenje različitih potreba rasvjete ne kompromitirajući stil. Učinak je zajamčen.





Deux pièces

Technical Overview

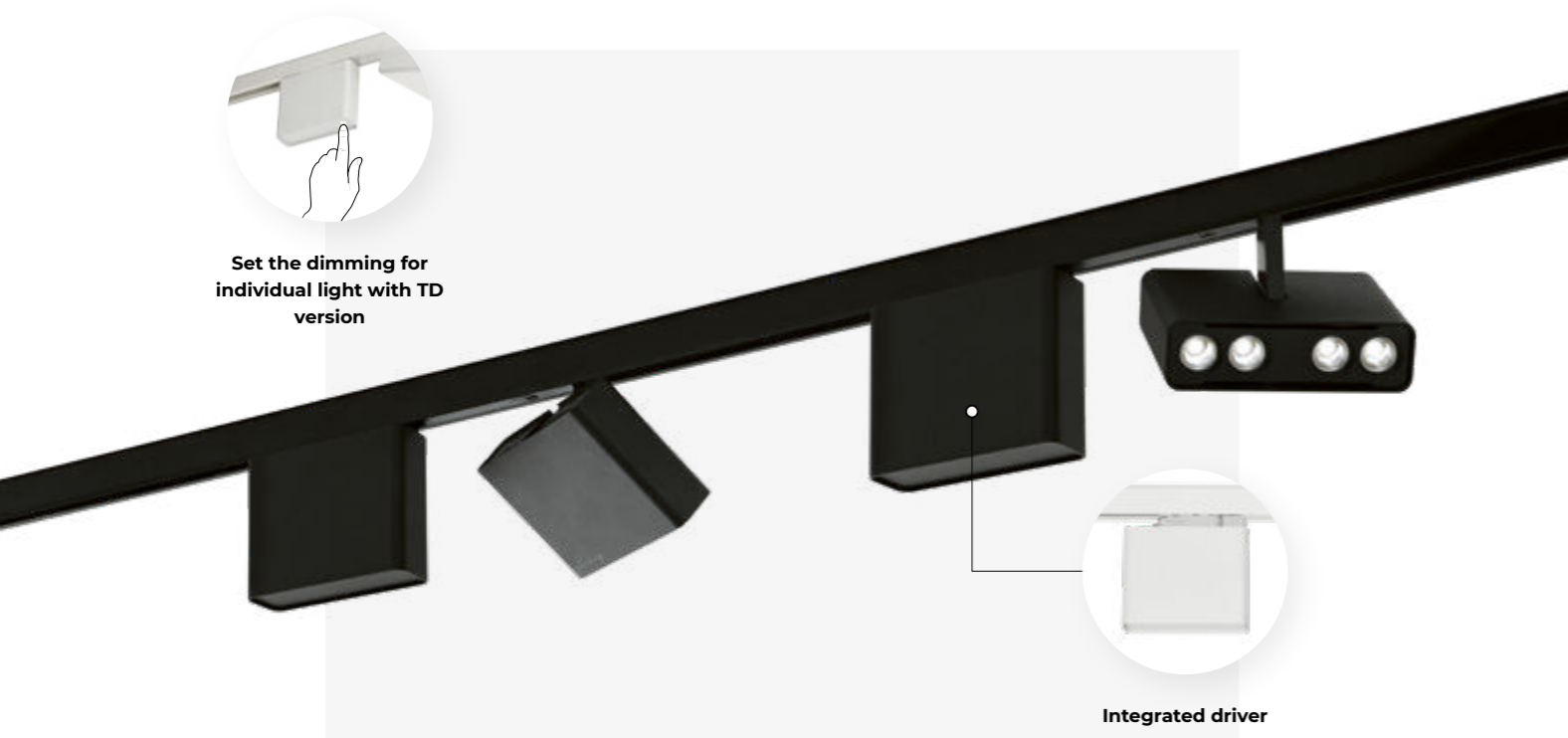

Set the dimming for individual light with TD version

Integrated driver

MAIN FEATURES

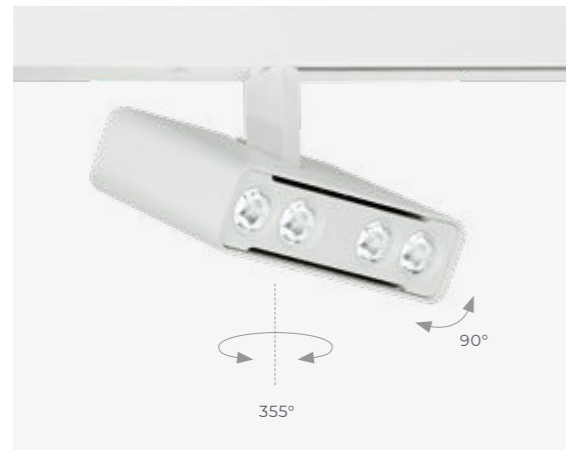

Rotate it to the desired direction

Its specific design makes it one of those pieces - whether you like it or not. There's no in-between. Because of lower lumen output, it is more suitable for home and hospitality.



Light effect only

When you want the luminaire to be discretely hidden and see only the effect of light, Deux pièces is a good solution.

	RI Recessed trim-less	T Track
Beam angle	20°, 30°, 55°	20°, 30°, 55°
Orientation	± 30°	90°, 355°
Luminaire luminous flux	up to 2650 lm (20°, 30°), 3300 lm (55°)	up to 2650 lm (20°, 30°), 3300 lm (55°)
LED colour	927, 930, 935, 940	927, 930, 935, 940
Driver	Casambi, DALI, FO	FO, TD
Driver position	Remote	Track adapter
Colour	1 2	1 2

Dimensions

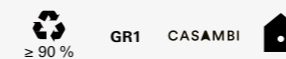
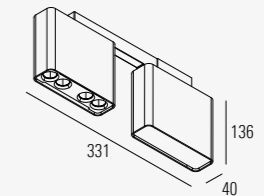
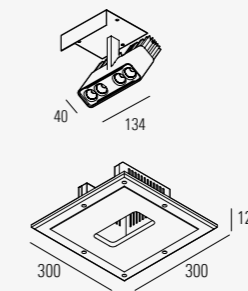

Light source: High-power COB LED, CRI>90, MacAdam≤2, 50.000h L90 B10 at 35°C. **Optic:** Highly efficient with uniform distribution, metalized polycarbonate with lacquer finish. **Body:** Aluminium, powder coated. **Control gear:** Integrated highly-efficient driver with fixed output (FO) or dimmable with Touch-dim push button for T version. For RI version constant current driver must be ordered separately. **Power supply:** 230V 50Hz / 500 - 900mA.

Svetlobni vir: Visoko učinkovit COB LED modul, CRI>90, barvno odstopanje MacAdam≤2, 50.000 h L90 B10 na 35 °C. **Optika:** Visoko učinkovit metaliziran in lakiran polikarbonat z enakomerno porazdelitvijo svetlobnega snopa. **Ohišje:** Aluminij, prašno barvan. **Napajalnik:** Integriran visoko učinkoviti LED konverter s konstantnim tokom (FO) ali regulacijskim izhodom (TD) preko vgrajene Touch-dim tipke. Za verzijo RI je potrebno ločeno naročiti LED konverter s konstantnim tokom. **Napajanje:** 230 V 50 Hz / 500 - 900 mA.

Izvor svetla: LED COB velike snage, CRI>90, MacAdam≤2, 50.000 h L90 B10 na 35 °C. **Optika:** Visoko učinkovit s jednolikom distribucijom, metaliziran polikarbonat sa završnim slojem laka. **Kućište:** Aluminijско, elektrostatski plastificirano. **Predspojne naprave:** Integrirana visokoefikasna predspojna naprava konstantnog izlaza (FO) ili dimabilna s Touch-dim tasterom za T inačicu. Za RI inačicu, predspojna naprava konstantnog izlaza mora se naručiti zasebno. **Napajanje:** 230 V 50 Hz / 500 - 900 mA.



Eye

Good looking all around

Don't roll your eyes, roll your Eye

There are really a lot of spots out there, but Eye is not just »one more spot«. Come closer. All the details are carefully thought out. Its clean elegant look with the possibility of a 360-degree orientation makes it a perfect luminaire for hospitality, retail and private residences.

Ne zavijajte z očmi, zavrtite Eye

Obstaja res veliko točkovnih svetil, vendar Eye ni zgolj eno izmed njih. Približajte se. Vsi detajli so skrbno preiščeni. Zaradi čistega elegantnega videza z možnostjo 360-stopinjske orientacije je popolna svetilka za gostinstvo, maloprodajo in zasebna bivališča.

Ne kolutajte očima, zakolutajte svoj Eye

Postoji zaista puno različnih reflektorov, ali Eye nije samo »još jedan obični reflektor«. Približi mu se. Svi njegovi detajli pažljivo su osmišljeni. Njegov čisti elegantni izgled s mogućnošću orijentacije od 360 stupnjeva čini ga savršenom svjetiljkom za ugostiteljstvo, maloprodaju i privatne rezidencije.







Watch video

MAIN FEATURES



Innovative swivel system

Eye is unique for the way it can be rotated in all directions, while the swivel mechanism remains invisible. Three types of optics allow a wide range of use.

Nothing is left to chance

All the details of this product communicate elegance, precision and perfection. Even when seen from the backside. In the track version the driver (FO, DALI or Casambi) is integrated in a track adapter.



Eye

Technical Overview



	C 60 Ceiling	C 80 Ceiling	T 60 Track	T 80 Track
Beam angle				
Reflector	34°, 45°	30°, 65°	34°, 45°	30°, 65°
Lens	22°, 26°, 46°	24°, 34°, 53°	10°, 22°, 26°, 46°	24°, 34°, 53°
Zoom lens	22° - 45°	-	22° - 45°	-
Orientation	65° / 360°	65° / 360°	65° / 350°	65° / 350°
Luminaire luminous flux	up to 1400 lm*	up to 2800 lm	up to 1400 lm	up to 2800 lm
LED colour	927, 930, 935, 940	830, 840, 927, 930 935, 940	927, 930, 935, 940	830, 840, 927, 930 935, 940
Driver	Casambi, DALI, FO	Casambi, DALI, FO	Casambi, DALI, FO	Casambi, DALI, FO
Driver position	Remote	Remote	Track adapter	Track adapter
Body colour	See the colour options below	See the colour options below	See the colour options below	See the colour options below
Inner colour	D Q	D Q	D Q	D Q

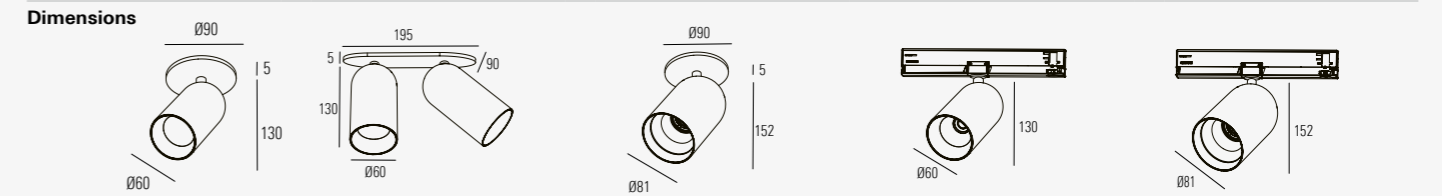

* The data refer to one spot. Multiply the number with the number of spots.

Standard: **1** **2** **3** **9** Special colours:



Light source: High-power COB LED, CRI>80/90, MacAdam≤2, 50.000h L90 B10 at 35°C. **Optic:** Highly efficient with uniform distribution, metalized polycarbonate with lacquer finish / Highly efficient PMMA optical lenses / Acrylic high efficiency lens with adjustable beam angle. **Body:** Aluminium, powder coated. **Control gear:** Integrated highly-efficient driver with fixed output (FO) or dimmable (DALI-TD, Casambi). / Some versions require externally mounted driver - order separately. **Power supply:** 230V 50Hz / 350 - 700mA.

Svetlobni vir: Visoko učinkovit COB LED modul, CRI>80/90, barvno odstopanje MacAdam≤2, 50.000 h L90 B10 na 35 °C. **Optika:** Visoko učinkovit metaliziran in lakiran polikarbonat z enakomerno porazdelitvijo svetlobnega snopa (ozek, srednji, široki svetlobni snop) / Visoko učinkovite PMMA optične leče (ozek, srednji, eliptični svetlobni snop) / Visoko učinkovite akrilne optične leče z nastavljivim kotom svetlobnega snopa. **Ohišje:** Aluminij, prašno barvan. **Napajalnik:** Integriran visoko učinkoviti LED konverter s konstantnim tokom (FO) ali regulacijskim izhodom (DALI-TD, Casambi). / Nekatere verzije zahtevajo zunanji LED konverter - naročiti ločeno. **Napajanje:** 230 V 50 Hz / 350 - 700 mA.

Izvor svjetla: LED COB velike snage, CRI 80/90, MacAdam≤2, 50.000 h L90 B10 na 35 °C. **Optika:** Visoko učinkovit s jednolikom distribucijom, metaliziran polikarbonat sa završnim slojem laka (spot, srednji, široki) / Visoko učinkovite PMMA leče (spot, srednja, eliptična) / Visokoeffikasna akrilna leča s podesivim kutem svetla. **Kućište:** Aluminijsko, elektrostatski plastificirano. **Predspojne naprave:** Integrirana visoko efikasna predspojna naprava konstantnog izlaza (FO) ili dimabilna (DALI-TD, Casambi). / Neke inačice zahtevaju izdvojenu predspojnu napravu - naručiti zasebno. **Napajanje:** 230 V 50 Hz / 350 - 700 mA.



BY CHICAGO ATHENAEUM



red dot design award winner



iF product design award



Pipes

Simple outside, clever inside

Its innovative design makes it irresistible

The simple shape is neutral and widely generic to fit easily anywhere. Thanks to variety of applications, an uncompromising performance and high efficiency, it has the power to point the attention and to create a special atmosphere in a space.

The front of the fixture is what makes it unique and different. To achieve high visual comfort the reflector is inwardly recessed, while the funnel acts as a transition zone to minimize the contrast.

Njegovemu inovativnemu dizajnu se ni moč upreti

Enostavna oblika svetila je nevtralna in dovolj splošna, da je primerna kjerkoli. Zaradi širokih možnosti uporabe, brezkompromisne kakovosti in visoke učinkovitosti lahko s tem svetilom usmerjamo pozornost in v prostoru ustvarjamo posebno vzdušje.

Edinstven in izrazito drugačen je sprednji del tega svetila. Da lahko ponudi izjemno svetlobno udobje, je svetlobni vir ugreznjen navznoter, kar omeji nivo bleščanja in zmešča prehod svetlobe po površini.

Njihov inovativan dizajn ih čini neodoljivim.

Jednostavan oblik je neutralan i svuda široko primjenjiv. Zahvaljujući raznovrsnosti primjena, nekompromisnoj izvedbi i visokoj učinkovitosti, ima moć usmjeriti pažnju i stvoriti poseban ugođaj u prostoru.

Prednji dio učvršćenja ga čini jedinstvenim i osobitim. Da bi se postigao visok vizualni komfor, reflektor je unutarnje recesiran, dok lijevak djeluje kao prijelazna zona za minimiziranje kontrasta.















407 Muzej Vučedolske kulture, Vukovar, Croatia / Architecture: Radionica arhitekture + Vanja Ilić / Photography: Miljenko Bernfest



Muzej Vučedolske kulture, Vukovar, Croatia / Architecture: Radionica arhitekture + Vanja Ilić / Photography: Miljenko Bernfest
 Asisi, Lutherstadt Wittenberg, Germany / Architecture: Spreeformat GmbH / Lighting design: Highlight / Photography: Intra lighting



MAIN FEATURES



A size for every need

From creating an atmosphere with low lighting scenario to a strong illumination we've got you covered.

Maximum adjustability

There is always a need to change the focus, but you shouldn't worry about that with Pipes, as it offers maximum adjustability and extra flexibility.



Pipes TC

Pipes TC is a compact spotlight with a central centre of gravity that prevents the track or profile from inclination. Its discreet design, power and small size make it probably the most useful track spotlight that can perfectly fit any interior.



Pipes 45

This is a nice solution for rooms where intense lighting is not needed, such as living rooms, hotel rooms etc.



Pipes SRI - You can move it up and down

How recessed do you prefer it? Play with heights, all with one product. It's easy to lock it with a single twist.

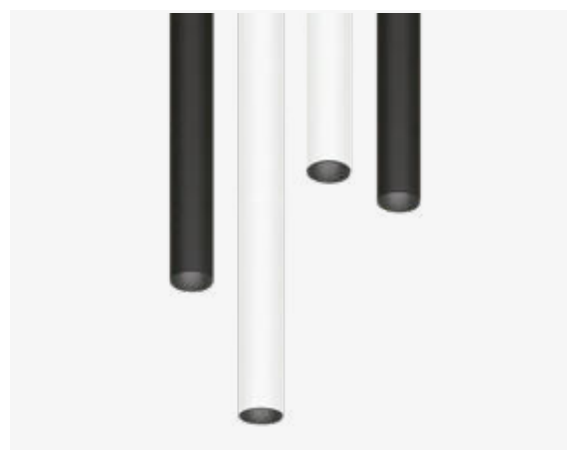

From Pipes S to Pipes Tube

Also, suspended spotlights can be a good solution for general lighting. Sometimes Pipes S is just too short. Combine it with longer versions of Pipes Tube.



PRO Optics

DECO Optics

Dynamic illumination



Tunable white technology

It allows you to get close to the dynamic of sunlight. You can set the colour temperature from cool to warm white upon your needs.

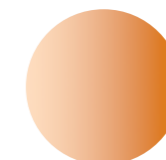

Dim to warm technology

Create a warm, soft, cosy and relaxing atmosphere. Like the one we achieved with the old light bulbs.

CRI for every occasion

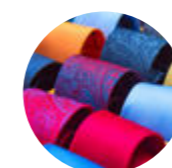

CRI>90 improves the appearance of objects. It leads to a natural and fresh appearance that brings out colours, textures, and shapes. It is perfect for retail stores, shops, restaurants, museums and galleries.



CRI>80 is suitable for general indoor illumination: residential applications, offices, hotels, schools, gyms.

Vivid COB



Warm Crispy



Warm Vivid



Fresh Rose



Alaska



Plant White



Clear White

Pipes

Technical Overview



PIPES RIO / RV
Semi recessed orientable



PIPES SRI
Semi recessed extractable

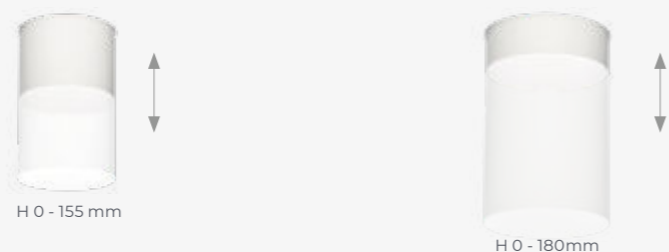

PIPES C / CF
Ceiling fixed / orientable



PIPES S*
Suspended



PIPES T
Track



Ø 45
Extra small



Ø 100
Small



Ø 133
Large



	DECO	DECO	PRO	DECO	PRO
Beam angle	20°, 30°, 55°	30°, 40°, 60°	15°, 30°, 36°, 56°	24°, 40°, 62°	15°, 30°, 36°, 56°
Zoom lens	-	21° - 47°	-	-	-
Luminaire luminous flux	up to 960 (20°, 30°), 1150 lm (55°)	up to 3600 lm	up to 3400 lm	up to 6200 lm	up to 4600 lm
LED colour	927, 930, 935, 940	827, 830, 840, 927, 930, 935, 940	830, 835, 840, 927, 930, 940	830, 840, 930, 940	830, 835, 840, 927, 930, 940
Dynamic light	Dim to warm (D2W)**	Tunable white 2700 - 6500K (TW)	Tunable white 2700 - 6500K (TW)	-	Tunable white 2700 - 6500K (TW)
Special LED colour	-	Alaska, Clear white, Fresh rose, Warm crispy, Warm vivid, Plant white	Alaska, Clear white, Fresh rose, Warm crispy, Warm vivid, Plant white	-	Alaska, Clear white, Fresh rose, Warm crispy, Warm vivid, Plant white
Driver	Casambi, DALI, FO	Casambi, DALI, FO	Casambi, DALI, FO	Casambi, DALI, FO	Casambi, DALI, FO

*Pipes S is available also with track adapter. **Dim to warm is possible on 55° beam angle. Honeycomb available for versions 100 DECO, or as accessory on 100 PRO and 133 PRO.

Standard: 1 2 Special colours:



Light source: High-power COB LED, CRI>80/90, MacAdam≤2, 50.000h L90 B10 at 35°C. **Optic:** Highly efficient with uniform distribution, metalized polycarbonate with lacquer finish / Highly efficient PMMA optical lenses / Acrylic high efficiency lens with adjustable beam angle. **Body:** Aluminium, powder coated. **Control gear:** Integrated highly-efficient driver with fixed output (FO) or dimmable (DALI, TD, Casambi). TD version is supplied with Touch-dim push button. / For RIO/RVO, SRI versions constant current driver must be ordered separately. **Power supply:** 230V 50Hz / 350 - 900mA.

Svetlobni vir: Visoko učinkovit COB LED modul, CRI>80/90, barvno odstopanje MacAdam≤2, 50.000 h L90 B10 na 35 °C. **Optika:** Visoko učinkovit metaliziran in lakiran polikarbonat z enakomerno porazdelitvijo svetlobnega snopa / Visoko učinkovite PMMA optične leče / Visoko učinkovite akrilne optične leče z nastavljivim kotom svetlobnega snopa. **Ohišje:** Aluminij, prašno barvan. **Napajalnik:** Integriran visoko učinkoviti LED konverter s konstantnim tokom (FO) ali regulacijskim izhodom (DALI-TD, Casambi). TD verzija vključuje Touch-dim tipko. / Za verzijo RIO/RVO, SRI je potrebno ločeno naročiti LED konverter s konstantnim tokom. **Napajanje:** 230 V 50 Hz / 350 - 900 mA.

Izvor svetla: LED COB velike snage, CRI 80/90, MacAdam≤2, 50.000 h L90 B10 na 35 °C. **Optika:** Visoko učinkovit s jednolikom distribucijom, metaliziran polikarbonat sa završnim slojem laka / Visoko učinkovite PMMA leče / Visokoefikasna akrilna leča s podesivim kutem svetla. **Kućište:** Aluminij, elektrostatski plastificirano. **Predspojne naprave:** Integrirana visoko efikasna predspojna naprava konstantnog izlaza (FO) ili dimabilna (DALI-TD, Casambi) TD verzija dolazi s Touch- dim integriranim tipkalom (TD). / Za RIO/RVO, SRI inačice, predspojne naprave konstantnog izlaza potrebno je naručiti zasebno **Napajanje:** 230 V 50 Hz / 350 - 900 mA.



Hunter

Call to action

Light can activate sales

Modern retail shops cannot afford to be uniform. To provoke the desired response of buyers, sections with high sales potential have to be enhanced in the right way.

Hunter spot is designed to make your products stand out and help you create a desirable overall brand experience.

Svetloba lahko sproži prodajo

Sodobne trgovine si ne morejo privoščiti enoličnosti. Da bi sprožili želen odziv kupcev, moramo področja z visokim prodajnim potencialom izpostaviti na pravi način.

Svetilo Hunter je zasnovano tako, da izdelkom omogoči, da izstopijo in hkrati pomaga ustvarjati željeno izkušnjo tržne znamke.

Svjetlo može potaknuti kupovinu

Suvremene maloprodajne trgovine si ne mogu priuštiti biti uniformne. Kako bi izazvali željeni odziv kupaca, dijelovi s većim prodajnim potencijalom moraju biti naglašeni na pravi način.

Hunter spot je oblikovan da istakne proizvode i pomogne stvoriti sveukupni željeni dojam branda.







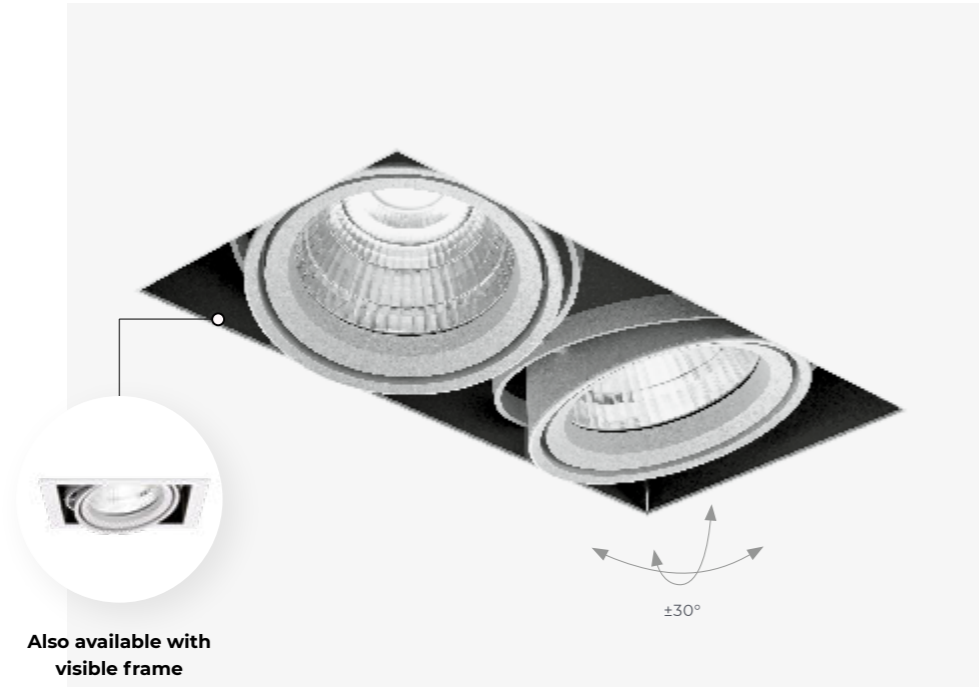
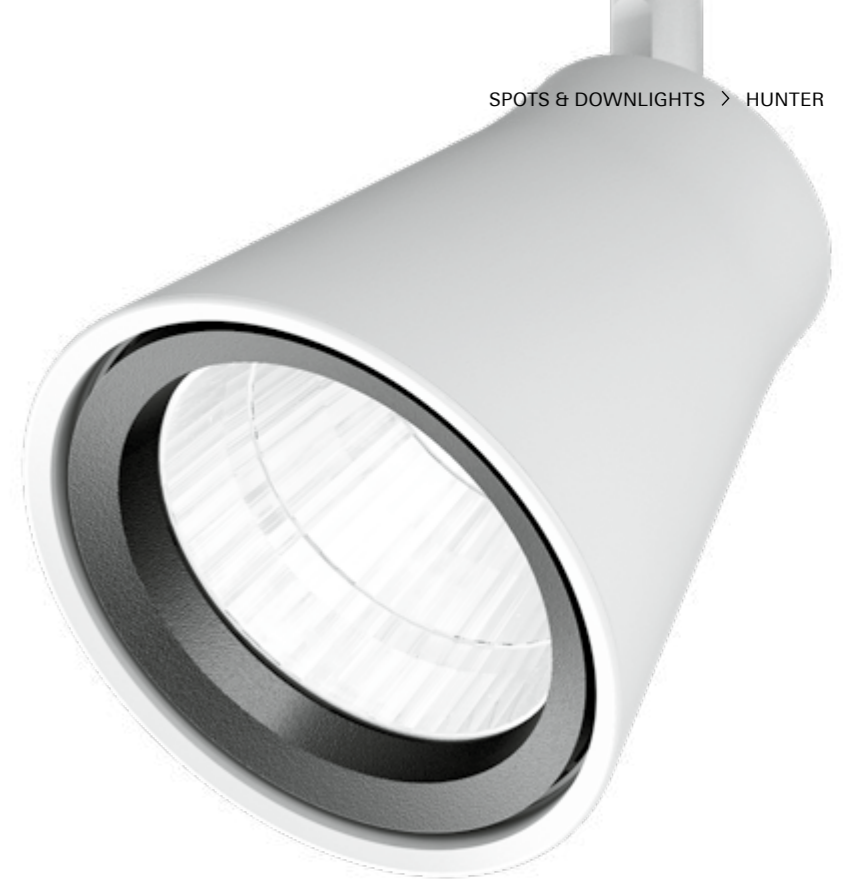

Also available with visible frame

MAIN FEATURES



General illumination with Hunter S

Hunter is different from classical tubes. It can be a good solution for general lighting in spaces with open ceilings.

Maximum adjustability

Thanks to its flexibility, Hunter can be oriented in the desired direction and adjusted the way you want. It is perfect for retail, big open spaces or galleries.



Dynamic illumination



Tunable white technology

It allows you to get close to the dynamic of sunlight. You can set the colour temperature from cool to warm white upon your needs.

CRI for every occasion

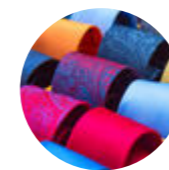

CRI>90 improves the appearance of objects. It leads to a natural and fresh appearance that brings out colours, textures, and shapes. It is perfect for retail stores, shops, restaurants, museums and galleries.



CRI>80 is suitable for general indoor illumination: residential applications, offices, hotels, schools, gyms.

Vivid COB



Warm Crispy



Warm Vivid



Plant White



Fresh Rose



Alaska



Clear White

Hunter

Technical Overview

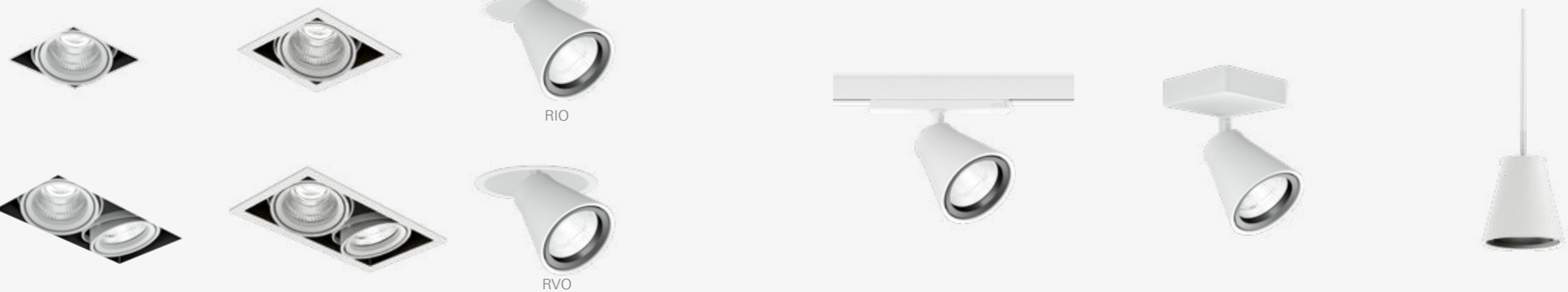

HUNTER

	RI	RV	RIO/RVO	T	C	S*
	Recessed trim-less	Recessed visible trim	Semi recessed trim-less / visible trim	Track	Ceiling	Suspended
Beam angle	15°, 24°, 54°	15°, 24°, 54°	15°, 24°, 54°	15°, 24°, 54°	15°, 24°, 54°	15°, 24°, 54°
Orientation	±30° / 360°	±30° / 360°	60° / 355°	60° / 355°	60° / 3°	-
Luminaire luminous flux	1400 - 9100 lm	1400 - 9100 lm	1400 - 5000 lm	900 - 4500 lm	900 - 4500 lm	900 - 5000 lm
LED colour	827, 830, 840, 930, 940	827, 830, 840, 930, 940	827, 830, 840, 930, 940	827, 830, 840, 930, 940	827, 830, 840, 930, 940	827, 830, 840, 930, 940
Dynamic light	Tunable white 2700 - 6500K	Tunable white 2700 - 6500K	Tunable white 2700 - 6500K	-	-	-
Special LED colour	Alaska, Clear white, Fresh rose, Plant white, Warm crispy, Warm vivid	Alaska, Clear white, Fresh rose, Plant white, Warm crispy, Warm vivid	Alaska, Clear white, Fresh rose, Plant white, Warm crispy, Warm vivid	Alaska, Clear white, Fresh rose, Plant white, Warm crispy, Warm vivid	Alaska, Clear white, Fresh rose, Plant white, Warm crispy, Warm vivid	Alaska, Clear white, Fresh rose, Plant white, Warm crispy, Warm vivid
Driver	Casambi, DALI, FO	Casambi, DALI, FO	Casambi, DALI, FO	Casambi, DALI, FO	Casambi, DALI, FO	Casambi, DALI, FO
Driver position	Remote	Remote	Remote	Track adapter	Integrated	Remote, Track adapter
Colour	1 2	1 2	1 2	1 2	1 2	1 2

Dimensions

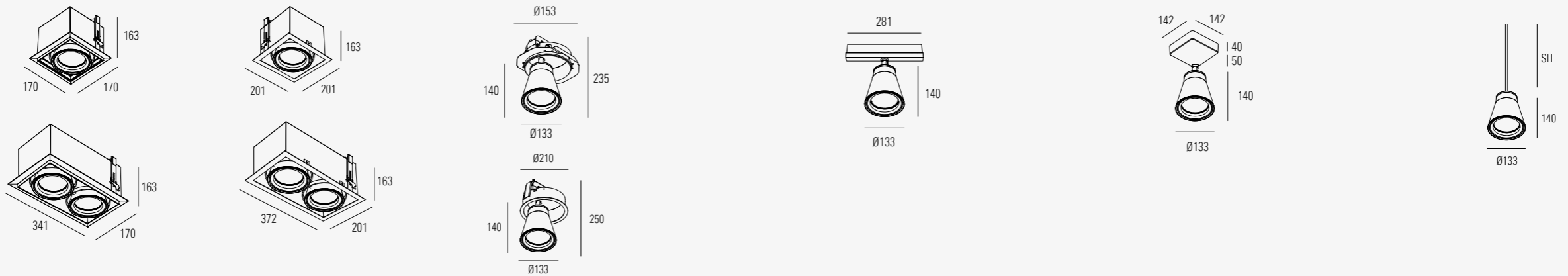

* Hunter S is available also with track adapter.



Light source: High-power COB LED, CRI>80/90, MacAdam≤2, 50.000h L90 B10 at 35°C. **Optic:** Highly efficient with uniform distribution, metalized polycarbonate with lacquer finish. **Body:** Aluminium, powder coated. / Steel-sheet housing with aluminium frame for RI/RV. **Control gear:** Integrated highly-efficient driver with fixed output (FO) or dimmable (DALI, Casambi). / For RIO/RVO/RI/RV versions constant current driver must be ordered separately. **Power supply:** 230V 50Hz / 500 - 1050mA.

Svetlobni vir: Visoko učinkovit COB LED modul, CRI>80/90, barvno odstopanje MacAdam≤2, 50.000 h L90 B10 na 35 °C. **Optika:** Visoko učinkovit metaliziran in lakiran polikarbonat z enakomerno porazdelitvijo svetlobnega snopa. **Ohišje:** Aluminij, prašno barvan. / Pločevinasto ohišje z aluminijastim okvirjem za RI/RV. **Napajalnik:** Integriran visoko učinkoviti LED konverter s konstantnim tokom (FO) ali regulacijskim izhodom (DALI, Casambi). / Za verzijo RIO/RVO/RI/RV je potrebno ločeno naročiti LED konverter s konstantnim tokom. **Napajanje:** 230 V 50 Hz / 500 - 1050 mA.

Izvor svetla: LED COB velike snage, CRI 80/90, MacAdam≤2, 50.000 h L90 B10 na 35 °C. **Optika:** Visoko učinkovit s jednolikom distribucijom, metaliziran polikarbonat sa završnim slojem laka. **Kućište:** Aluminijsko, elektrostatski plastificirano. / Čelično kućište sa aluminijским okvirom za RI/RV. **Predspojne naprave:** Integrirana visoko efikasna predspojna naprava konstantnog izlaza (FO) ili dimabilna (DALI, Casambi). / Za RIO/RVO/RI/RV inačice, predspojne naprave konstantnog izlaza potrebno je naručiti zasebno **Napajanje:** 230 V 50 Hz / 500 - 1050 mA.



Cub

Hide and seek

Two functions, two stories

A common problem in apartment buildings is that electric connections are usually in the wrong place. This was our inspiration when creating the Cub, a light that can be used as a classical spotlight, that blends into the surroundings of your concrete ceilings, or as a system of lights that will seamlessly conceal the electrical installation and relocate it wherever you need it.

Don't let the size of this luminaire fool you: it offers a strong spotlight and high efficiency, but at the same time gives an opportunity to create an eye-catching element which gives your space character.

Dve uporabnosti, dve zgodbi

Ena izmed pogostih težav stanovanjskih zgradb je, da so električne napeljave vedno na napačnem mestu. Omenjeni problem je bil naš glavni navdih pri ustvarjanju svetila Cub, saj ga lahko uporabite kot klasično točkovno svetilo in ga diskretno umestite v vaš betonski strop, ali pa kot sistem svetil, ki elegantno skrrije električno napeljavo in jo premakne točno tja, kjer jo potrebujete.

Naj vas velikost tega svetila ne zavede, Cub slovi po svoji visoki učinkovitosti, hkrati pa vam daje priložnost, da z njim prostoru vdahnete karakter.

Dvije funkcije, dvije priče

Čest problem u stambenim zgradama je da su električne veze obično na pogrešnom mjestu. To je bila naša inspiracija prilikom stvaranja Cube-a, svjetla koja se može koristiti kao klasično spot svjetlo, koje se uklapa u okolinu vaših betonskih stropova ili kao sustav svjetala koji će besprijekorno skrivati električnu instalaciju i preseliti ju gdje god je potrebno.

Ne dopustite da vas veličina ovog rasvjetnog tijela prevvari: ono pruža snažan izvor svjetlosti i visoku učinkovitost, ali istodobno i priliku za stvaranje privlačnog elementa koji vašem prostoru daje karakter.





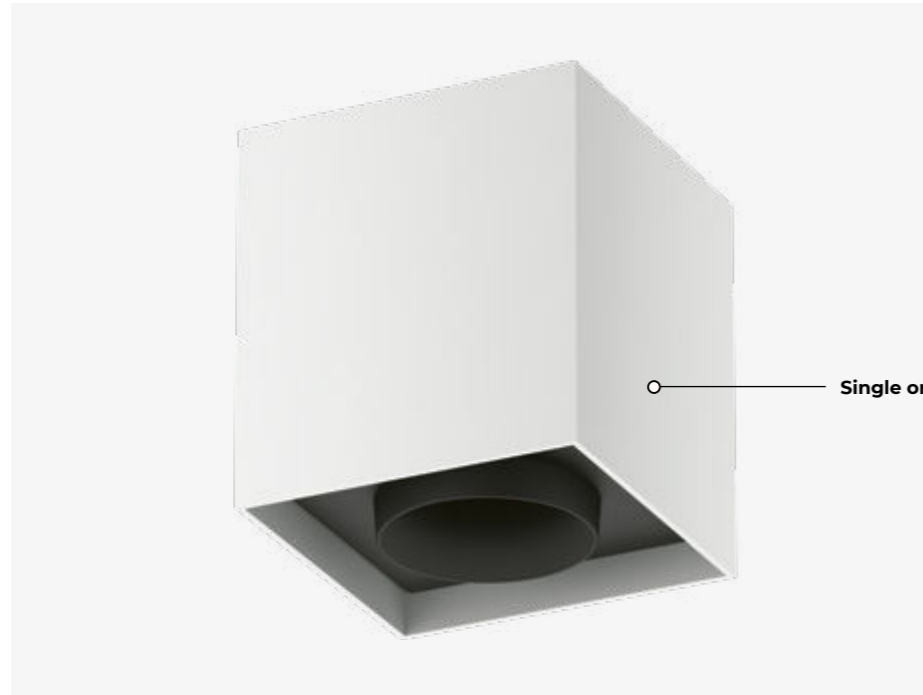

MAIN FEATURES



Goodbye to all those wires. They are hidden!

Cub can be combined in a system of three spots. All the electrical connections are hidden in a bar, together with an integrated driver.



Diverse choice and simple installation

You can choose among five different colour temperatures. Moreover, very simple installation is its great advantage.

Cub

Technical Overview



	CUB C	CUB C3
Beam angle	20°, 30°, 55°	20°, 30°, 55°
Luminaire luminous flux	up to 1050 (20°, 30°), 1400 lm (55°)	up to 1050 (20°, 30°), 1400 lm (55°)
LED colour	927, 930, 935, 940	927, 930, 935, 940
Driver	Casambi, DALI, FO	Casambi, DALI, FO
Driver position	Integrated (FO), Remote (DALI, Casambi)	Integrated
Colour	1 2	1 2

Dimensions

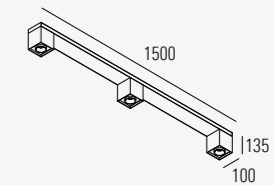
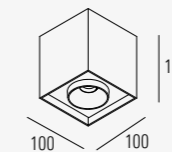

The data refer to one spot. Multiply the number with the number of spots.



Light source: High-power COB LED, CRI>90, MacAdam≤2, 50.000h L90 B10 at 35°C. **Optic:** Highly efficient with uniform distribution, metalized polycarbonate with lacquer finish. **Body:** Aluminium, powder coated. **Control gear:** Integrated highly-efficient driver with fixed output (FO) or dimmable (DALI, Casambi). Some versions require externally mounted driver - order separately. **Power supply:** 230V 50Hz / 150 - 900 mA.

Svetlobni vir: Visoko učinkovit COB LED modul, CRI>90, barvno odstopanje MacAdam≤2, 50.000 h L90 B10 na 35 °C. **Optika:** Visoko učinkovit metaliziran in lakiran polikarbonat z enakomerno porazdelitvijo svetlobnega snopa. **Ohišje:** Aluminij, prašno barvan. **Napajalnik:** Integriran visoko učinkoviti LED konverter s konstantnim tokom (FO) ali regulacijskim izhodom (DALI, Casambi). Nekatere verzije zahtevajo zunanji LED konverter - naročiti ločeno. **Napajanje:** 230 V 50 Hz / 150 - 900 mA.

Izvor svetla: LED COB velike snage, CRI>90, MacAdam≤2, 50.000 h L90 B10 na 35 °C. **Optika:** Visoko učinkovit s jednolikom distribucijom, metaliziran polikarbonat sa završnim slojem laka. **Kućište:** Aluminijско, elektrostatski plastificirano. **Predspojne naprave:** Integrirana visoko efikasna predspojna naprava konstantnog izlaza (FO) ili dimabilna (DALI, Casambi). Neke inačice zahtjevaju izdvojenu predspojnu napravo - naručiti zasebno. **Napajanje:** 230 V 50 Hz / 150 - 900 mA.



reddot design award
winner



Flott

Not a typical downlight

Designed to make an ambient performance

Flott fits best when you need a downlight with character. Since it is multifunctional and changeable, it enhances the space and makes it look a little different every time.

Depending on the time of the day or activity taking place, you can switch lighting scenarios between the floating effect with backlight, RGB colour change or spot illumination.

Narejen, da ustvari učinek v prostoru

Flott je najboljša izbira takrat, ko potrebujete točkovo svetilo s karakterjem. Ker je večfunkcionalen in spremenljiv, prostor ustrezno poudari in hkrati poskrbi, da vsakič izgleda nekoliko drugače.

Glede na čas v dnevu in aktivnosti lahko menjujete svetlobne scene - od lebdečega efekta z indirektno svetlobo, RGB menjavanja barve, do usmerjene svetlobe.

Oblikovano za stvaranje ambijentalnog efekta

Flott najbolje odgovara kad trebate downlight s karakterom. Budući da je višefunkcionalno, unaprjeđuje prostor i svaki put ga naizgled čini malo drugačijim.

Zavisno o dobu dana ili aktivnosti, možete prebaciti scenarije rasvjete između lebdećeg efekta s pozadinskim indirektnim osvjetljenjem, RGB promjene boje ili reflektorskog osvjetljenja.





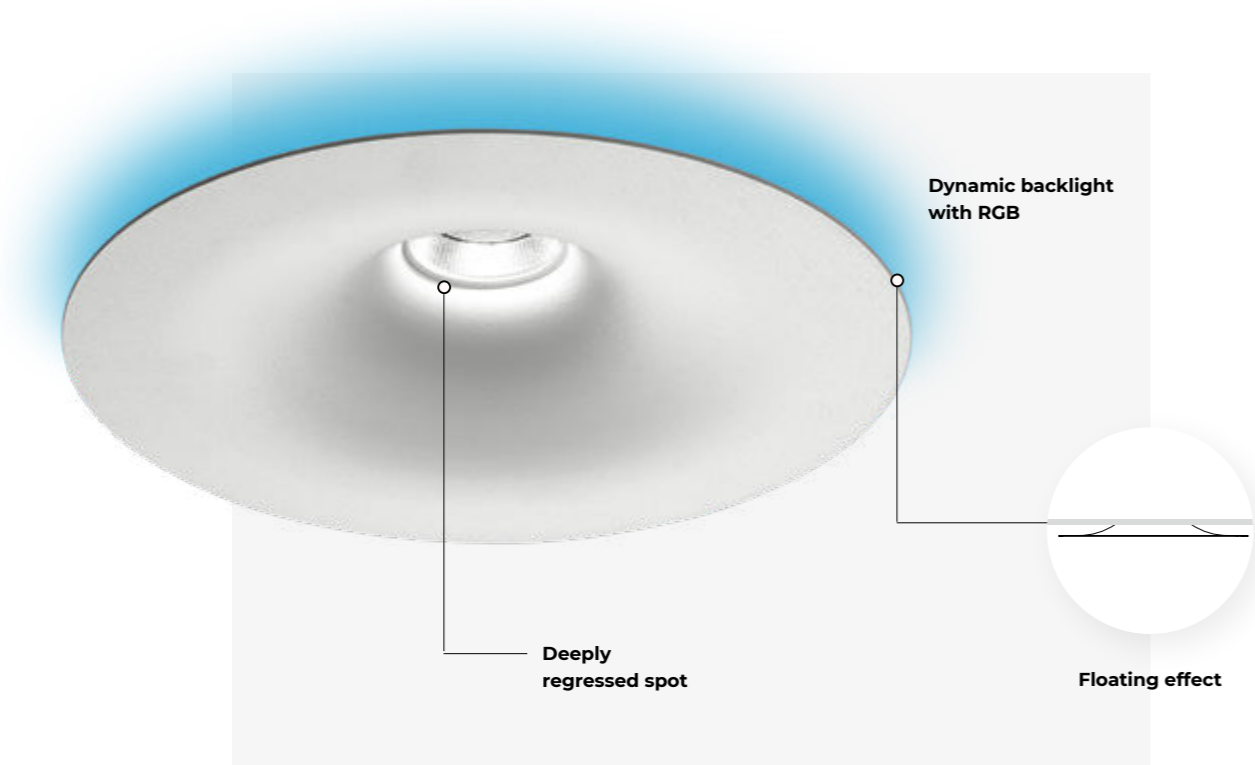

MAIN FEATURES

One product, 3 scenes

Depending on the time of the day or activity taking place, you can switch lighting scenarios to accommodate your needs. Mix the floating effect with the backlight, RGB colour change and spot illumination.

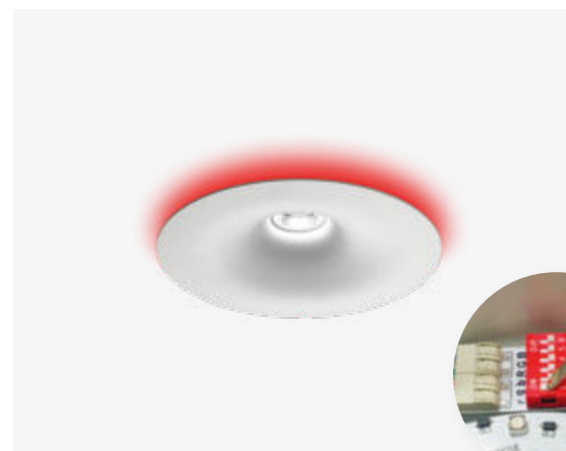

Dynamic backlight

Full RGB version enables dynamic colour mixing with external RGB controller. RGB switch version contains driver and switcher for stable colour selection. With DIP switch combination 16 different backlight colours can be set.

Flott

Technical Overview



	RV S Small	RV L Large
Beam angle	20°, 30°, 40°	15°, 30°, 56°
Luminaire luminous flux	700 - 2000 lm	1400 - 3000 lm
LED colour	927, 930, 935, 940	927, 930, 935, 940
Dynamic illumination	RGB	RGB
Driver	DALI, FO	DALI, FO
Colour	1	1

Dimensions

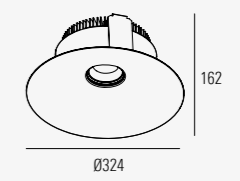
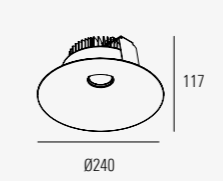

Light source: High-power COB LED, CRI>80/90, MacAdam≤2, 50.000h L90 B10 at 35°C. RGB LED for backlight. **Optic:** Highly efficient with uniform distribution, metalized polycarbonate with lacquer finish. **Body:** Aluminium, powder coated. **Control gear:** Supplied with highly-efficient driver with fixed output (FO) or dimmable (DALI) for direct spot light. Indirect decorative RGB component require external driver and controller only for full RGB version. RGB switch version is supplied with driver. **Power supply:** 230V 50Hz + RGB 24V.

Svetlobni vir: Visoko učinkovit COB LED modul, CRI>80/90, barvno odstopanje MacAdam≤2, 50.000 h L90 B10 na 35°C. RGB LED za indirektno osvetlitev. **Optika:** Visoko učinkovit metaliziran in lakiran polikarbonat z enakomerno porazdelitvijo svetlobnega snopa. **Ohišje:** Aluminij, prašno barvan. **Napajalnik:** Priložen visoko učinkoviti LED konverter s konstantnim tokom (FO) ali regulacijskim izhodom (DALI) za direktno osvetlitev. Full RGB različica zahteva LED konverter in RGB krmilnik - ločeno naročanje. RGB switch različici je priložen LED konverter. **Napajanje:** 230 V 50 Hz + RGB 24 V.

Izvor svetla: LED COB velike snage, CRI 80/90, MacAdam≤2, 50.000 h L90 B10 na 35°C. RGB LED za backlight. **Optika:** Visoko učinkovit s jednolikom distribucijom, metaliziran polikarbonat sa završnim slojem laka. **Kućište:** Aluminijsko, elektrostatski plastificirano. **Predspojne naprave:** U kompletu s visoko efikasnom predspojnom napravom konstantnog izlaza (FO) ili dimabilna (DALI) za direktnu komponentu. Indirektna dekorativna RGB rasvjeta zahtjeva kontroler i napajanje za dinamičnu RGB rasvjetu. RGB switch verzija je opremljena predspojnom napravom. **Napajanje:** 230 V 50 Hz + RGB 24 V.



Nitor

Simply efficient

Taking efficiency way beyond energy saving

The classic downlight has been fundamentally improved and overhauled. With uncompromising performance, maximum efficiency and with a wide variety of applications it has become an indispensable part of (almost) every project.

It's also a relamping opportunity, where energy consumption can be decreased by up to 70% and a fast payback time can be reached. Moreover, with the same diameter, the luminaire replacement is quick and clean, with no need for additional ceiling work.

Učinkovitost preko meja varčevanja z energijo

Ta klasičen reflektor je temeljito izboljšan. Z brez-kompromisno kakovostjo, maksimalno učinkovitostjo in širokimi možnostmi uporabe je postal nepogrešljiv del (skoraj) vsakega projekta.

Je odlična rešitev ob zamenjavi razsvetljave, saj omogoča zmanjšanje porabe energije do 70 % in kratek čas povrnitve investiranega denarja. Še več, z ohranitvijo enakih dimenzij je zamenjava svetila hitra in čista, brez dodatnih posegov v strop.

Dovođenje učinkovitosti daleko dalje od uštede energije

Klasični downlight unaprijeđen iz temelja. S nekompromisnom izvedbom, maksimalnom učinkovitošću i širokom raznolikošću primjena, postalo je nezamjenjivi dio (gotovo) svakog projekta.

Također i kao zamjena za postojeće svjetiljke, gdje potrošnja energije može biti smanjena za do 70 % s kratkim rokom povrata investicije. Štoviše, unutar istog promjera, zamjena rasvjete je brza i čista, bez potrebe za dodatnim stropnim radovima.





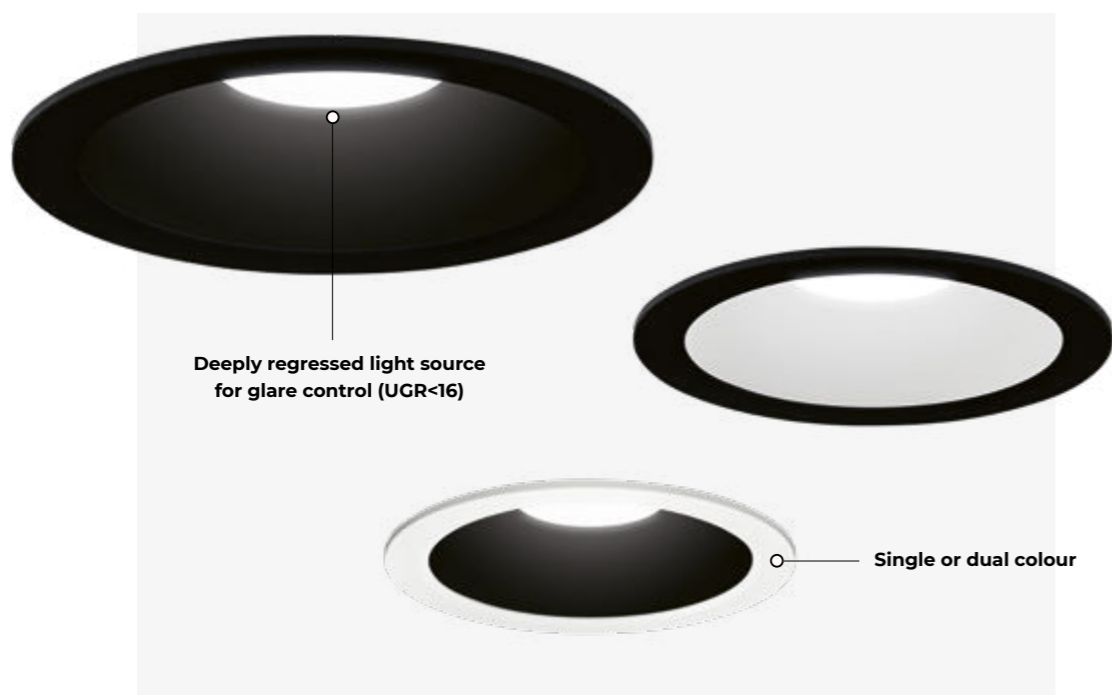

PRO RANGE

PRO range, UGR<16

The light source is deeply integrated for glare control. The product is efficient at various heights, available with different lumen packages and beam angles.



Up to 6560 lm, covering high ceilings

High-ceiling scenarios, such as those found in airports, convention halls, and shopping malls, require high-output illumination fixtures without casting shadows or leaving dark spots on the areas below.



OTHER MODELS

Flat version in a compact size

Available with satin opal diffuser (SOP) for soft general illumination or with soft-light prismatic optics (DPR) for controlled luminance. It's perfect if you have limited mounting height.



High efficiency optics

Aluminium vacuum metalized, high-efficiency optic with micro-prismatic lens provides homogeneous efficient illumination. Available also with transparent glass for IP44.

Nitor

Technical Overview



FLAT
Soft diffused light



PRO
Low glare spot



PRO HC
High ceilings spot



PRO AS
Asymmetric spot



IP20



IP44

HE
High efficiency optic

Beam angle / Optics	DPR, SOP	15°, 30°, 56°	10°, 15°	AS	Wide
Luminaire luminous flux	970 - 2200 lm	3400 - 4900 lm	3800 - 6600 lm	3500 - 4500 lm	3800 - 4800 lm
LED colour	827, 830, 835, 840, 930, 940	830, 840, 927, 930, 935, 940	830, 840, 927, 930, 935, 940	830, 840, 927, 930, 935, 940	830, 840, 927, 930, 935, 940
Dynamic colour	Tunable white 2700 - 6500K	Tunable white 2700 - 6500K	-	-	Tunable white 2700 - 6500K
Glare control	-	UGR<16	UGR<16	-	-
Driver	Casambi, DALI, FO	Casambi, DALI, FO	Casambi, DALI, FO	Casambi, DALI, FO	Casambi, DALI, FO
Driver position	Remote	Remote	Remote	Remote	Remote
IP protection	IP54	IP20	IP20	IP20	IP20 / IP44*
Colour / Inner colour	1 2	1 2	1 2	1 2	1 2

Dimensions

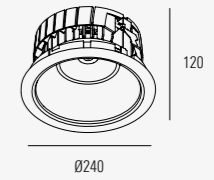
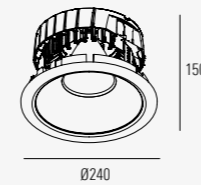
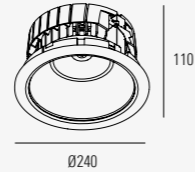
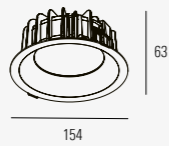

The data refer to one spot. Multiply the number with the number of spots.



Light source: High-flux PCB LED modules, mid-power SMD LED, CRI>80/90, MacAdam≤2, 50.000h L90 B10 at 35°C. / High-power COB LED, CRI>80/90, MacAdam≤2, 50.000h L90 B10 at 35°C. **Optic:** Satin opal polycarbonate diffuser (SOP) / Soft-light prismatic PMMA diffuser (DPR) / Highly efficient optic with uniform distribution, metalized polycarbonate, lacquer finish with funnel made from polycarbonate. **Body:** Polycarbonate body with die-cast aluminium heat sink. **Control gear:** Constant current driver - order separately. **Power supply:** 350 - 750mA / 250 - 1050mA.

Svetlobni vir: PCB LED moduli visoke svetilnosti, z SMD LED, CRI>80/90, barvno odstopanje MacAdam≤2, 50.000 h L90 B10 na 35 °C. / Visoko učinkovit COB LED modul, CRI>80/90, barvno odstopanje MacAdam≤2, 50.000 h L90 B10 na 35 °C. **Optika:** Satinirani opalni polikarbonatni difuzor (SOP) / Mikro-prizmatična difuzna PMMA optika (DPR) / Visoko učinkovit metaliziran in lakiran polikarbonat z enakomerno porazdelitvijo svetlobnega snopa, lijak iz polikarbonata. **Ohišje:** Polikarbonat s hladilnikom iz tlačno litega aluminija. **Napajalnik:** LED konverter s konstantnim tokom - ločeno naročanje. **Napajanje:** 350 - 750 mA / 250 - 1050 mA.

Izvor svetla: PCB LED moduli velikog svetlosnog toka, SMD LED srednje snage, CRI>80/90, MacAdam≤2, 50.000 h L90 B10 na 35 °C. / LED COB velike snage, CRI 80/90, MacAdam≤2, 50.000 h L90 B10 na 35 °C. **Optika:** Satinirani opalni polikarbonatni difuzor (SOP) / Mikroprizmatična difuzna PMMA optika (DPR) / Visoko učinkovit s jednolikom distribucijom, metaliziran polikarbonat sa završnim slojem laka. Lijevak izrađen od polikarbonata. **Kućište:** Polikarbonat s hladnjakom od tlačno lijevanog aluminija. **Predspojne naprave:** Predspojna naprava konstantne struje - naručiti zasebno. **Napajanje:** 350 - 750 mA / 250 - 1050 mA.



Narro

Not round at all

For all the square reasons, simply the best

Improved light quality and high luminaire efficiency are the main advantage of Narro. It guarantees a high level of functionality and excellent light distribution.

Thanks to many innovative features, the efficiency level is optimized, installation is quick and easy. Due to top-quality material, energy-saving technology and various finishes Narro is the ideal lighting solution for public and business areas.

Za vse kvadratne izzive, preprosto najboljši

Izboljšana kakovost svetlobe in visoka učinkovitost sta glavni prednosti svetila Narro, ki hkrati zagotavlja visoko stopnjo funkcionalnosti in odlično distribucijo svetlobe.

Izrazito inovativne lastnosti tega svetila omogočajo optimalno učinkovitost ter hitro in enostavno montažo. S svojimi vrhunskimi materiali, energijsko varčno tehnologijo in različnimi končnimi obdelavami je Narro idealna svetlobna rešitev za javne in poslovne prostore.

Za sva kvadratna rješenja, jednostavno najbolji

Poboljšana kvaliteta svjetlosti i visoka učinkovitost glavna su prednost svjetiljke Narro. Jamči visoku razinu učinkovitosti te izvrsnu raspodjelu svjetlosti.

Zahvaljujući mnogim inovativnim značajkama, razina učinkovitosti je optimizirana, ugradnja je brza i laka. Materijali vrhunske kvalitete, ušteda energije te razne završne obrade, čine Narro idealnim rješenjem za javne i poslovne prostore.





MAIN FEATURES



PRO range, UGR<16

The light source is deeply recessed for glare control. The product is efficient at various heights, available with different lumen packages and beam angles.

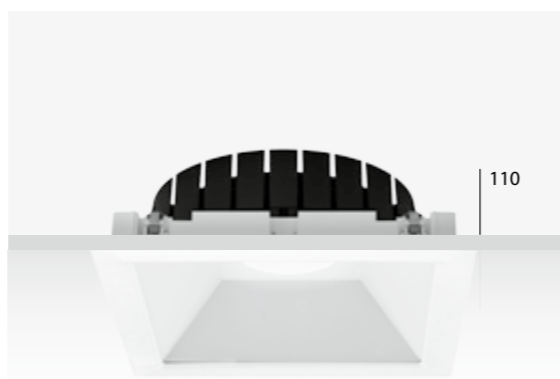

Flat version

It is perfect if you have limited mounting height available (min 110 mm). Available with satin opal diffuser (SOP) for soft general illumination or with soft-light prismatic optics (DPR) for controlled luminance.

Narro

Technical Overview



	FLAT Soft diffused light	PRO Low glare spot
Optics / Beam angle	DPR, SOP	15°, 30°, 56°
Luminaire luminous flux	950 - 2200 lm	3400 - 4900 lm
LED colour	827, 830, 835, 840, 930, 940	827, 830, 840, 930, 940
Dynamic colour	Tunable white 2700 - 6500K	Tunable white 2700 - 6500K
Glare control	-	UGR <16
Driver	Casambi, DALI, FO	Casambi, DALI, FO
Driver position	Remote	Remote
IP protection	IP44*	IP20
Colour / Inner colour	1 2	1 2

Dimensions

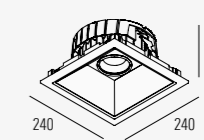
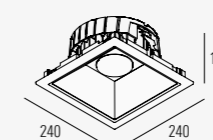

*IP value from the exposed side.



Light source: High-flux PCB LED modules, mid-power SMD LED, CRI>80/90, MacAdam≤2, 50.000h L90 B10 at 35°C. / High-power COB LED, CRI>80/90, MacAdam≤2, 50.000h L90 B10 at 35°C. **Optic:** Satin opal polycarbonate diffuser (SOP) / Soft-light prismatic PMMA diffuser (DPR) / Highly efficient optic with uniform distribution, metalized polycarbonate, lacquer finish with funnel made from polycarbonate. **Body:** Polycarbonate body with die-cast aluminium heat sink. **Control gear:** Constant current driver - order separately. **Power supply:** 350 - 750mA / 250 - 1050mA.

Svetlobni vir: PCB LED moduli visoke svetilnosti, z SMD LED, CRI>80/90, barvno odstopanje MacAdam≤2, 50.000 h L90 B10 na 35 °C. / Visoko učinkovit COB LED modul, CRI>80/90, barvno odstopanje MacAdam≤2, 50.000 h L90 B10 na 35 °C. **Optika:** Satinirani opalni polikarbonatni difuzor (SOP) / Mikroprizmatična difuzna PMMA optika (DPR) / Visoko učinkovit metaliziran in lakiran polikarbonat z enakomerno porazdelitvijo svetlobnega snopa, lijak iz polikarbonata. **Ohišje:** Polikarbonat s hladilnikom iz tlačno litega aluminija. **Napajalnik:** LED konverter s konstantnim tokom - ločeno naročanje. **Napajanje:** 350 - 750 mA / 250 - 1050 mA.

Izvor svetla: PCB LED moduli velikog svjetlosnog toka, SMD LED srednje snage, CRI>80/90, MacAdam≤2, 50.000 h L90 B10 na 35°C. / LED COB velike snage, CRI 80/90, MacAdam≤2, 50.000 h L90 B10 na 35°C. **Optika:** Satinirani opalni polikarbonatni difuzor (SOP) / Mikroprizmatična difuzna PMMA optika (DPR) / Visoko učinkovit s jednolikom distribucijom, metaliziran polikarbonat sa završnim slojem laka. Lijevak izrađen od polikarbonata. **Kućište:** Polikarbonat s hladnjakom od tlačno lijevanog aluminija. **Predspojne naprave:** Predspojna naprava konstantne struje - naručiti zasebno. **Napajanje:** 350 - 750 mA / 250 - 1050 mA.

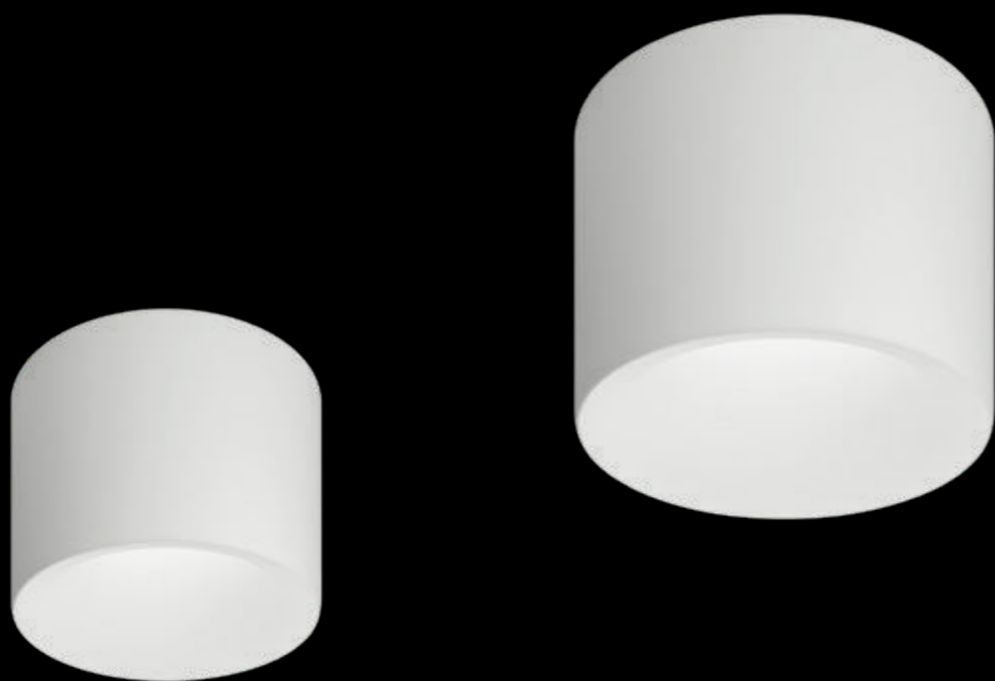

Nucleo

It's a one-piece thing

A downlight that moved on

When creating a downlight, efficiency and performance are still features we strive for, without compromising the look and a simple clean design. We've upgraded a classic downlight and created a luminaire that is highly efficient and also a true beauty in the segment of surface-mounted downlights. And its specialty? It's made from just one piece, without harsh edges and screws. How cool is that?

Thanks to its delicate shape Nucleo offers an illumination without any glare. It is suitable also for corridors or concrete ceilings that have no option for recessed downlights.

Več kot le običajna svetilka

Pri razvoju novega svetila vedno stremimo k učinkovitosti, ne da bi se odrekli estetskemu videzu in izčiščenemu dizajnu. Nadgradili smo klasično točkovo svetilo in ustvarili visoko učinkovito svetilko, ki v svojem segmentu izstopa po lepoti. Njena posebnost? Izdelana je iz samo enega kosa materiala, brez ostrih robov in vijakov. Sliši se imenitno, kajne?

Zaradi svoje prefinjene oblike Nucleo omogoča osvetlitev brez bleščanja. Primeren je za osvetlitev hodnikov ali betonskih stropov, kjer možnosti za vgradno svetilko ni.

Downlighter koji je nastaviodalje

Prilikom stvaranja downlightera, učinkovitost i svojstva još uvijek su značajke kojima težimo, bez ugrožavanja izgleda i jednostavnog čistog dizajna. Nadgradili smo klasični downlighter i stvorili rasvjetno tijelo koje je vrlo učinkovito, ali i prava ljepotica u segmentu montažnog površinskog downlightera. Njegova specijalnost? Izrađen je od samo jednog komada, bez oštih rubova i vijaka. Nije li to cool?

Zahvaljujući finom izgledu, Nucleo nudi osvjetljenje bez ikakvog blještanja. Pogodan je i za hodnike ili betonske stropove koji nemaju mogućnost za ugradni downlighter.



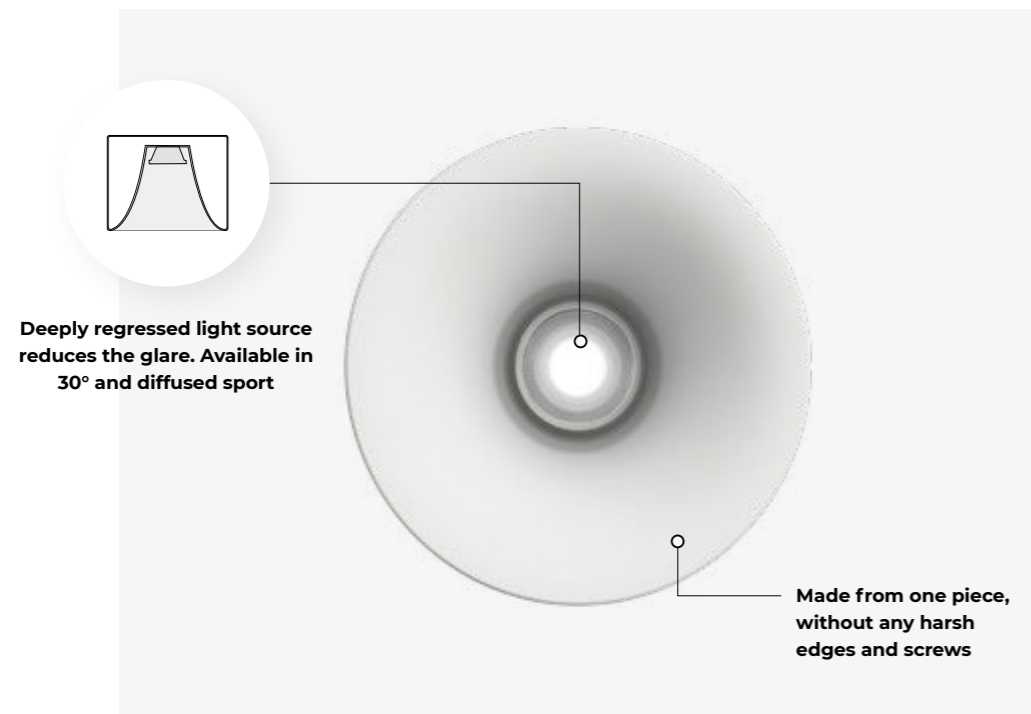

MAIN FEATURES



Efficient light with no glare

Thanks to its delicate shape, Nucleo offers an illumination without any glare. It is suitable for corridors or concrete ceilings that have no option for recessed downlights.

Nucleo

Technical Overview



FAMILY MEMBER



TECH. SPECS

LED COLOUR	DRIVER	LUMINAIRE LUMINOUS FLUX	OPTIC	EMERGENCY KIT
830, 840, 927, 930, 935, 940	Casambi, DALI, FO	850 - 4000 lm	30°, Diffused	EM 1h / 3h

COLOURS

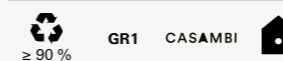
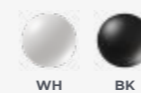

Light source: High-power COB LED, CRI>80/90, MacAdam≤2, 50.000h L90 B10 at 35°C. **Optic:** Highly efficient with uniform distribution, metalized polycarbonate with lacquer finish. Satined prismatic lens dome for uniform light distribution. **Body:** Aluminium, powder coated. **Control gear:** Integrated highly-efficient driver with fixed output (FO) or dimmable (DALI-TD, Casambi). **Emergency:** Emergency kit version with autonomy 1h or 3h. **Power supply:** 230V 50Hz.

Svetlobni vir: Visoko učinkovit COB LED modul, CRI>80/90, barvno odstopanje MacAdam≤2, 50.000 h L90 B10 na 35 °C. **Optika:** Visoko učinkovit metaliziran in lakiran polikarbonat z enakomerno porazdelitvijo svetlobnega snopa. Satinirana prizmatična kupola za enakomerno osvetlitev. **Ohišje:** Aluminij, prašno barvan. **Napajalnik:** Integriran visoko učinkoviti LED konverter s konstantnim tokom (FO) ali regulacijskim izhodom (DALI-TD, Casambi). **Varnostni modul:** Varnostni modul z 1 ali 3 urami avtonomije. **Napajanje:** 230 V 50 Hz.

Izvor svetla: LED COB velike snage, CRI 80/90, MacAdam≤2, 50.000 h L90 B10 na 35°C. **Optika:** Visoko učinkovit s jednolikom distribucijom, metaliziran polikarbonat sa završnim slojem laka. Satinirana prizmatična kupola za ravnomjernu osvijetljenost. **Kućište:** Aluminijsko, elektrostatski plastificirano. **Predspojne naprave:** Integrirana visoko efikasna predspojna naprava konstantnog izlaza (FO) ili dimabilna (DALI-TD, Casambi). **Režim nužne rasvjete:** Modul nužne rasvjete autonomije 1 ili 3h. **Napajanje:** 230V 50Hz.



Nola

Lona's little sister

Soft light doesn't need to come in a big size product

Challenge its small size and put it in lighting compositions that follow the architecture, use it to give people guidance or draw attention to what needs to be seen.

And if it's not enough exciting already, creating a unique lighting system using Nola can be even more fun if you pair it with its bigger sister Lona and get an elegant detail that highlights the important part of the architecture, or combine it with linear luminaires to create a discrete guidance through space. It's a luminaire that can easily catch the rhythm of your architecture, enriching it with excitement, and making every heart skip a beat.

Do mehke razpršene svetlobe tudi z majhnim svetilom

Ustvarite z Nolo svetlobne kompozicije, ki sledijo arhitekturi, usmerjajo ali poudarjajo, kar želimo izpostaviti.

Zelo posrečena je v igrivi kombinaciji z Lono, njeno večjo različico, pa tudi z linijskimi svetili, s katerimi vas bo lepo vodila skozi prostor. Nola je svetilo, ki zlahka ujame ritem arhitekture prostora. Vedno navduši in pospeši utrip vašega srca.

Meko svetlo ne moraju nužno stvarati veliki proizvodi

Neka vam njegova mala veličina bude izazov - smjestite ga u rasvjetne sastave koji slijede arhitekturu, upotrijebite ga kako biste ljude usmjerili ili privukli pozornost na ono što treba biti zamiječeno.

A ako spomenuto nije samo po sebi dovoljno uzbudljivo, stvaranje jedinstvenog sustava rasvjete pomoću Nole može biti još zabavnije ako ga uparite s njegovom većom sestrom Lonom i dobijete elegantan detalj koji naglašava važan dio arhitekture ili ga kombinira s linearnim rasvjetnim tijelima kako bi stvorili diskretno vođenje kroz prostor. To je rasvjetno tijelo koje može lako dohvatiti ritem vaše arhitekture, obogaćujući ga uzbuđenjem, i ushićujući vaše srce.







MAIN FEATURES



Soft, diffused light

At first sight, Nola looks like a spot, but with its diffuser it can make a soft dispersed light. A black regressed funnel importantly improves the visual comfort and reduces the glare.

Small but efficient

Nola can be a perfect solution in offices with open ceilings.

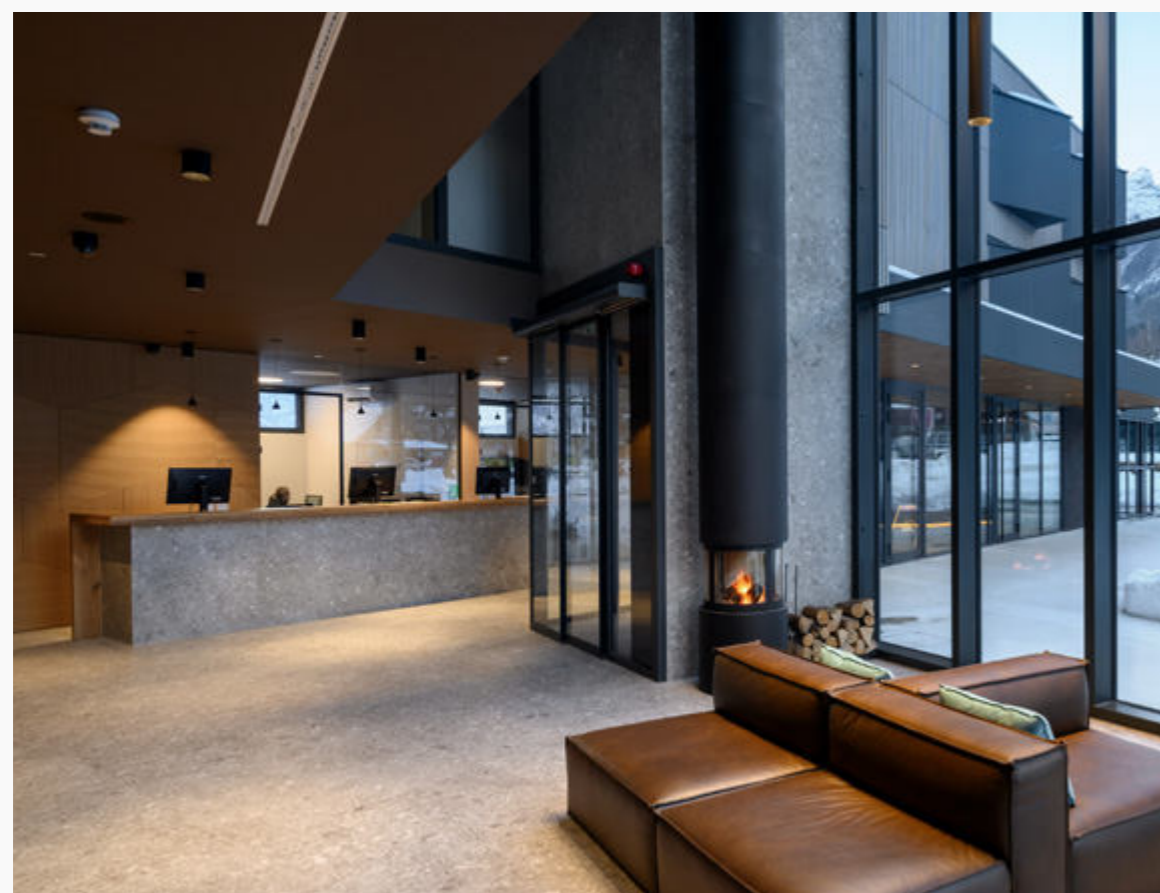

Nola

Technical Overview



REGRESSED



FLAT



RV
Recessed visible trim

C
Ceiling

C
Ceiling with integrated driver

S
Suspended

Optics	DPR, SOP	DPR, SOP	DPR, SOP	DPR, SOP
Luminaire luminous flux	850 - 1550 lm	850 - 1550 lm	540 - 1300 lm	540 - 1300 lm
LED colour	827, 830, 835, 840, 930, 940	827, 830, 835, 840, 930, 940	827, 830, 835, 840, 930, 940	827, 830, 835, 840, 930, 940
Dynamic colour	Tunable white 2700 - 6500K	Tunable white 2700 - 6500K	-	-
Driver	Casambi, DALI, FO	Casambi, DALI, FO	Casambi, DALI, FO	Casambi, DALI, FO
Driver position	Remote	Remote	Integrated	Remote, Ceiling cup
IP protection	IP44*	IP43	IP43	IP40

Dimensions

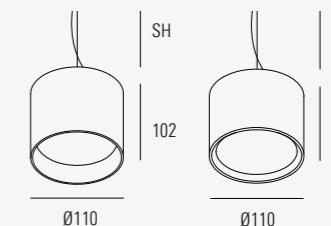
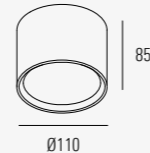
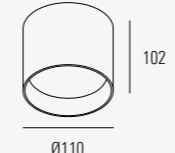

*IP value from the exposed side. / RV Flat version is available in white or black, while other versions offer a dual colour selection.



Light source: High-flux PCB LED modules, mid-power SMD LED, CRI>80/90, MacAdam≤2, 50.000h L90 B10 at 35°C. **Optic:** Satin opal polycarbonate diffuser (SOP), Soft-light prismatic PMMA diffuser (DPR). **Body:** Aluminium, powder coated. **Ceiling cup:** Ceiling cup with or without driver must be ordered separately. **Control gear:** Integrated highly-efficient driver with fixed output (FO) or dimmable (DALI, Casambi). Some versions require externally mounted driver - order separately. **Power supply:** 230V 50Hz / 250 - 500mA.

Svetlobni vir: PCB LED moduli visoke svetilnosti, z SMD LED, CRI>80/90, barvno odstopanje MacAdam≤2, 50.000 h L90 B10 na 35 °C. **Optika:** Satinirani opalni polikarbonatni difuzor (SOP), Mikro-prizmatična difuzna PMMA optika (DPR). **Ohišje:** Aluminij, prašno barvan. **Stropna rozeta:** Stropna rozeta z ali brez LED konverterja je potrebno naročiti ločeno. **Napajalnik:** Integriran visoko učinkoviti LED konverter s konstantnim tokom (FO) ali regulacijskim izhodom (DALI, Casambi). Nekatere verzije zahtevajo zunanji LED konverter - naročiti ločeno. **Napajanje:** 230 V 50 Hz / 250 - 500 mA.

Inner colour: **B** **D** Standard: **B** **D** **J** Special colours:

Izvor svetla: PCB LED moduli velikog svetlosnog toka, SMD LED srednje snage, CRI>80/90, MacAdam≤2, 50.000 h L90 B10 na 35 °C. **Optika:** Satinirani opalni polikarbonatni difuzor (SOP), Mikroprizmatična difuzna PMMA optika (DPR). **Kućište:** Aluminijsko, elektrostatski plastificirano. **Stropna rozeta:** Stropna rozeta sa ili bez predspojne naprave naručuje se zasebno. **Predspojne naprave:** Integrirana visoko efikasna predspojna naprava konstantnog izlaza (FO) ili dimabilna (DALI, Casambi). Neke inačice zahtijevaju izdvojenu predspojnu napravo - naručiti zasebno. **Napajanje:** 230 V 50 Hz / 250 - 500 mA.

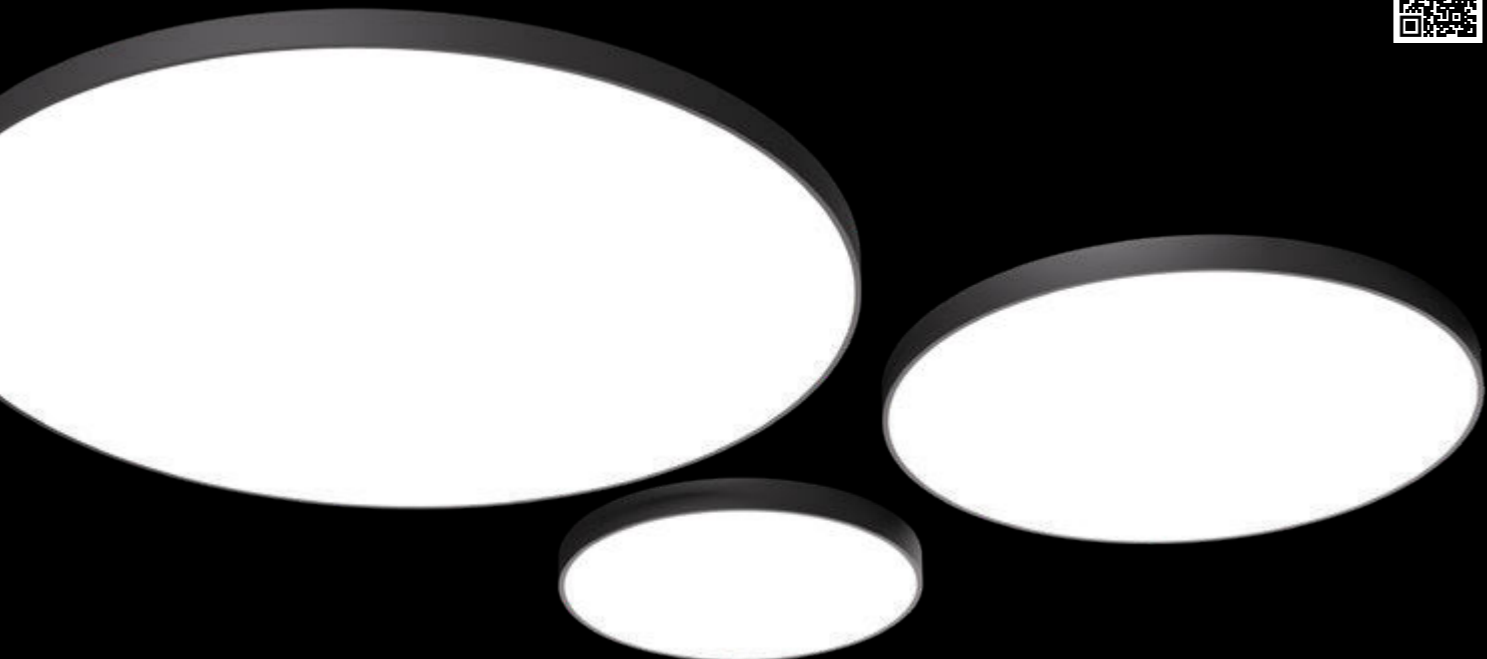

Lona

Fits everywhere

Round will never go out of style

Lona is a simple product, yet it can shape originality by creative use in space. As it comes in different sizes and mounting possibilities, there are so many ways to combine different luminaires.

Its ability to blend in or stand out makes it easy to match any interior. Especially in unlimited spaces, Lona will add a focal point without losing the feeling of spaciousness.

Okroglo ne bo nikoli iz mode

Lona je enostaven izdelek, ki pa omogoča veliko izvirnosti in ustvarjalnosti pri uporabi. Ker je na voljo v različnih velikostih in načinih montaže, je možnosti kombinacij posameznih izdelkov med sabo nešteto.

Lepo se ujema z vsakim interierjem, saj se lahko ali povsem povsem diskretno zlije z okoljem ali stopi v ospredje. Posebej v zelo odprtih prostorih lahko z Lono vedno ustvarimo žariščno točko, ne da bi izgubili občutek prostornosti.

Okruglo nikad ne izlazi iz mode

Lona je jednostavan proizvod, no kreativnim odabirom, može se ostvariti originalnost i posebnost. Brojne varijante dimenzija i načina montaže, omogućuju razne primjene svjetiljaka.

Njena sposobnost da se u isto vrijeme stopi i istakne, čini ju prikladnom za bilo kakav prostor. Lona će dodati naglasak, žarišnu točku bez da će oduzeti karakter prostoru.











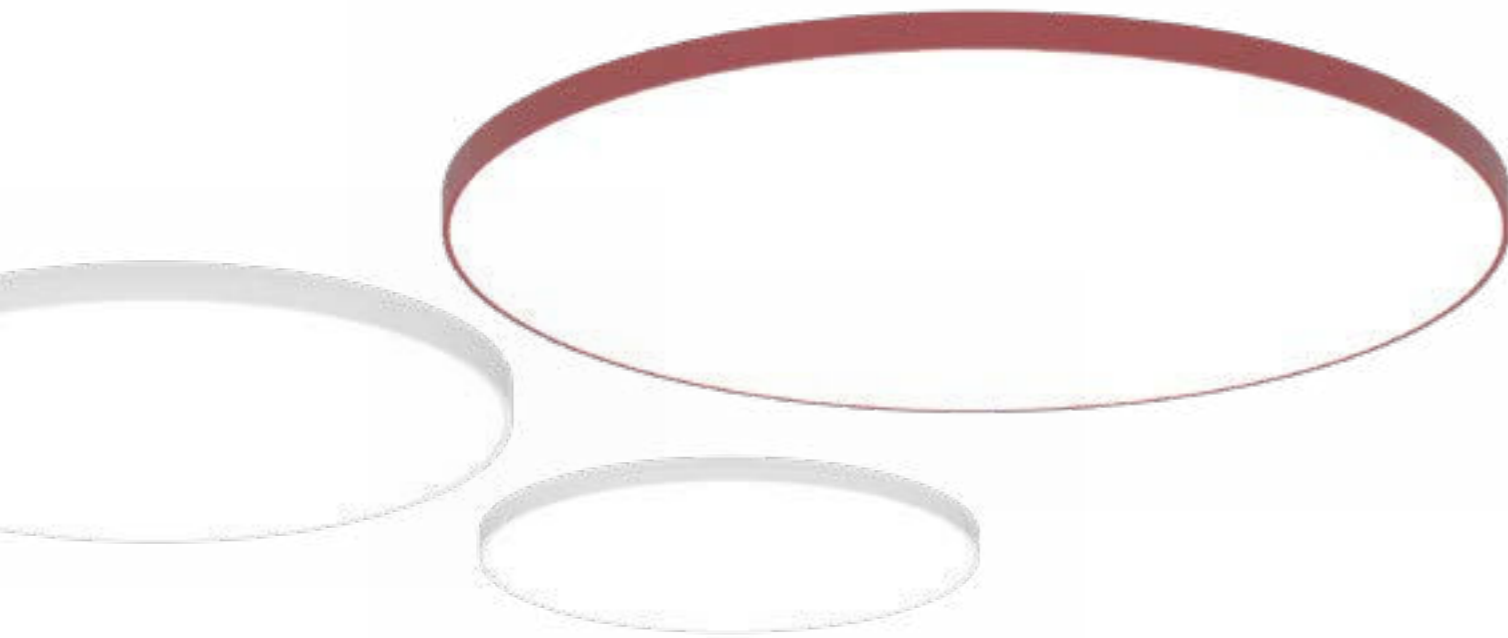

MAIN FEATURES

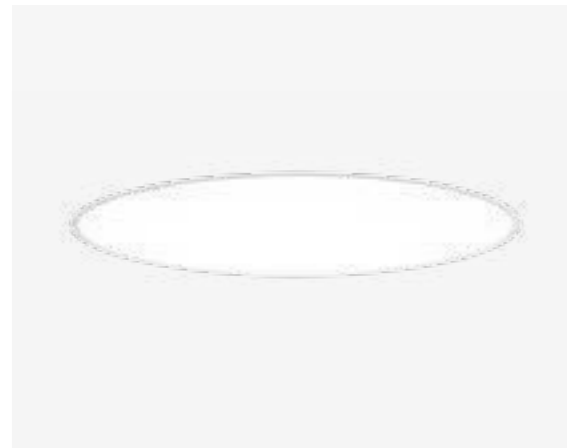
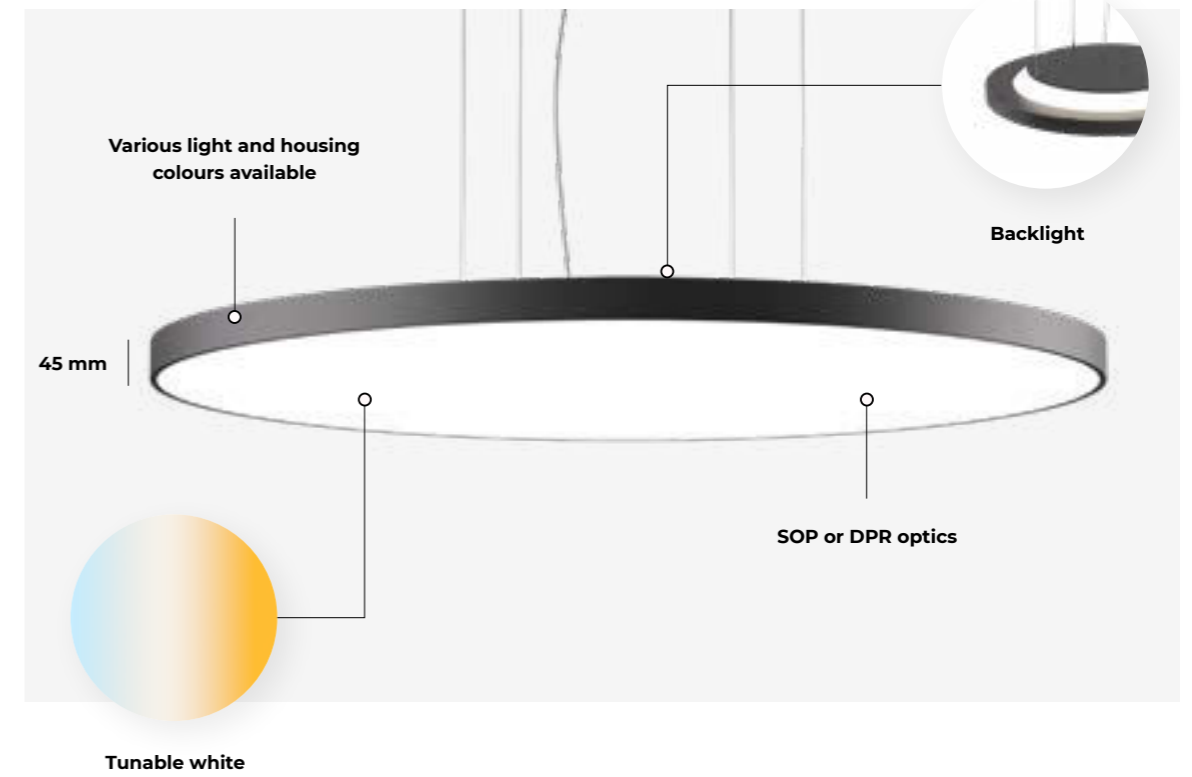

Soft diffused light

Soft homogeneous illumination with soft shadows enhances people's well-being and optically enlarges the space. The ceiling looks clean due to its discreet form.

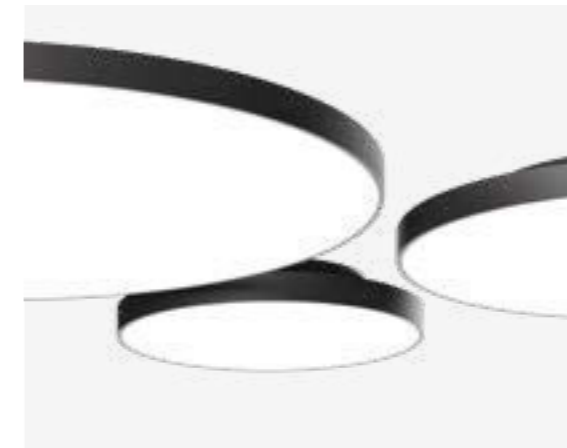

Different sizes, same height

It gets easy to mix and match Lonas together. With its timeless shape, the positioning in the room is entirely flexible. The new Lona is thinner and much more elegant.

With or without backlight

The backlight gives an added value to a standard ceiling lamp. The illuminated ceiling brings a new dimension to the space and creates a pleasant feeling.



Easy to install

With a locking mechanism, the installation of Lona is fast and straightforward. The electrical connection is possible without opening the luminaire. Wall (W) installation of ceiling versions 300, 400 is possible.



Lona

Technical Overview



LONA RV

Recessed visible trim



Ø 310 mm
h 100 mm



Ø 408 mm
h 100 mm



Ø 638 mm
h 120 mm



Ø 950 mm
h 120 mm

LONA C/S

Ceiling / Suspended



Ø 300mm

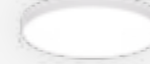

Ø 400 mm



Ø 600 mm



Ø 900 mm

LONA CDI

Ceiling Direct / Indirect



Ø 300mm



Ø 400 mm



Ø 600 mm



Ø 900 mm

LONA SDI

Suspended Direct / Indirect



Ø 300mm



Ø 400 mm



Ø 600 mm



Ø 900 mm

	300	400	600	900
Optics	SOP, DPR	SOP, DPR	SOP, DPR	SOP, DPR
Luminaire luminous flux (direct)	1150 - 1800 lm	1750 - 2700 lm	2800 - 4400 lm	6400 - 10300 lm
Luminaire luminous flux (indirect)	790 lm	790 lm	1100 lm	1700 lm
Light distribution	Direct, Direct / Indirect	Direct, Direct / Indirect	Direct, Direct / Indirect	Direct, Direct / Indirect
LED colour	827, 830, 840, 930, 940	827, 830, 840, 930, 940	827, 830, 840, 930, 940	827, 830, 840, 930, 940
Dynamic colour	-	Tunable white 2700 - 6500K	Tunable white 2700 - 6500K	Tunable white 2700 - 6500K
Driver	Casambi, DALI, FO	Casambi, DALI, FO	Casambi, DALI, FO	Casambi, DALI, FO
Emergency kit	-	EM 1h, EM 3h	EM 1h, EM 3h	EM 1h, EM 3h
IP protection	IP43 / IP40 (S, SDI, W)	IP43 / IP40 (S, SDI, W)	IP43 / IP40 (S, SDI)	IP43 / IP40 (S, SDI)
Dimensions	45 83 300	45 83 400	45 83 600	45 82 900

Suspended version are suspended on 4 suspensions or Y suspension for sizes 300 - 600 mm. / RV version available in white and black. / Wall (W) installation of ceiling versions 300, 400 is possible.

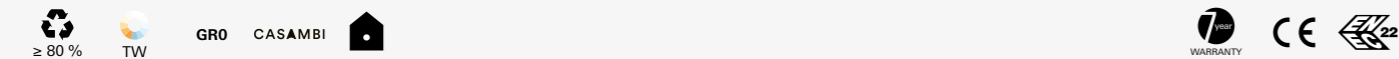

Light source: High-flux PCB LED modules, mid-power SMD LED, CRI>80/90, MacAdam≤2, 50.000h L90 B10 at 35°C. **Optic:** Satin opal PMMA diffuser (SOP) / Soft-light prismatic PMMA diffuser (DPR). **Body:** Aluminium, powder or PVD coated. / Steel-sheet, powder coated. **Ceiling cup:** For suspended versions, the ceiling cup and suspension set must be ordered separately. Find out more on the technical pages or online product Configurator. **Control gear:** Integrated highly-efficient driver with fixed output (FO) or dimmable (DALI-TD, Casambi). Optional separate switching for direct / indirect versions. Option of on/off microwave sensor. **Emergency:** Emergency kit version with autonomy 1h or 3h. **Power supply:** 230V 50Hz.

Svetlobni vir: PCB LED moduli visoke svetlosti, z SMD LED, CRI>80/90, barvno odstopanje MacAdam≤2, 50.000 h L90 B10 na 35 °C. **Optika:** Satinirani opalni PMMA difuzor (SOP) / Mikro-prizmatična difuzna PMMA optika (DPR). **Ohišje:** Aluminij, prašno ali PVD barvano. / Pločevina, prašno barvana. **Napajalnik:** Integriran visoko učinkoviti LED konverter s konstantnim tokom (FO) ali regulacijskim izhodom (DALI-TD, Casambi). Opcijsko ločeno prižiganje direktne / indirektne komponente. Microwave senzor za FO konverter. **Varnostni modul:** Varnostni modul z 1 ali 3 urami avtonomije. **Napajanje:** 230 V 50 Hz.

Standard: **B** **D** **J** Special colours:

Izvor svetla: PCB LED moduli velikog svjetlosnog toka, SMD LED srednje snage, CRI>80/90, MacAdam≤2, 50.000 h L90 B10 na 35 °C. **Optika:** Satinirani opalni PMMA difuzor (SOP) / Mikroprizmatična difuzna PMMA optika (DPR). **Kućište:** Aluminij, praškasto ili PVD plastificiran. / Dekapirani čelik, elektrostatski plastificiran. **Predspojne naprave:** Integrirana visoko efikasna predspojna naprava konstantnog izlaza (FO) ili dimabilna (DALI-TD, Casambi). Odvojeno paljenje direktne/indirektne komponente na zahtjev. Mikrovalni senzor za FO konverter. **Režim nužne rasvjete:** Modul nužne rasvjete autonomije 1 ili 3 h. **Napajanje:** 230 V 50 Hz.

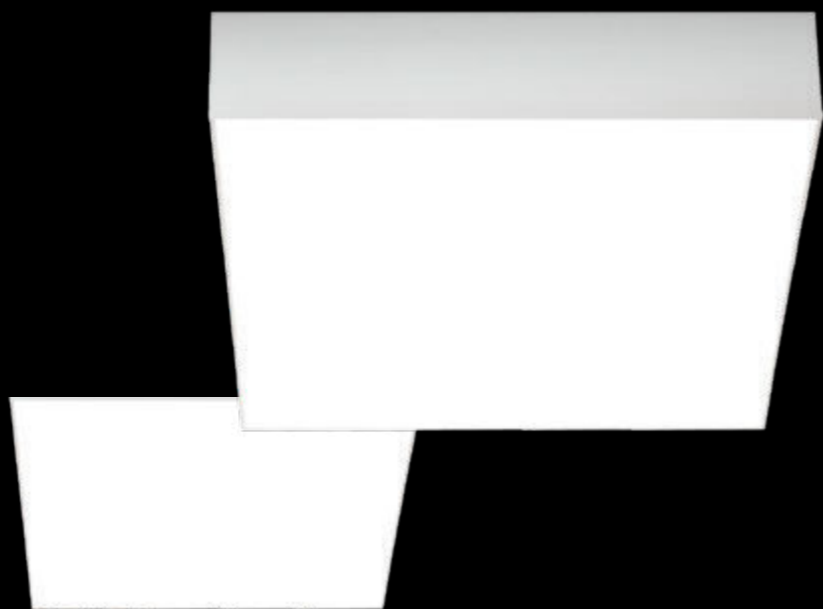

Karo

Simply square

There are places, where a square shape just fits in

The basic geometric shape is representing the pure and the rational. The expected choice would be to link the same forms together, but sometimes, beauty comes from doing the opposite so as to surprise.

An interesting space needs both, structure and softness. The Karo's basic form adds some order into the entirety of space.

So prostori, kjer brez kvadratne oblike ne gre

Ta osnovna geometrijska oblika predstavlja čistost in racionalnost. Povezovanje enakih oblik bi bila predvidljiva odločitev. Toda včasih je lepota ravno v nasprotnem, v tem, da presenetimo.

Zanimiv prostor potrebuje oboje, strukturo in mehko. Oblika svetila Karo daje celotnemu prostoru predvsem občutek reda.

Postoje mjesta gdje se kvadratni oblik naprosto uklapa

Osnovni geometrijski oblik predstavlja čisto i racionalno. Očekivani izbor bi bio povezati iste oblike zajedno, ali ponekad ljepota iznenađujuće dolazi čineći suprotno.

Zanimljiv prostor treba oboje, strukturu i mekoću. Osnovni oblik svjetiljke Karo unosi osjećaj reda u cjelokupan prostor.





Karo

Technical Overview



RV
Recessed visible trim



C
Ceiling



S
Suspended



	300	400	1200
Optics	SOP, DPR	SOP, DPR	SOP
Luminaire luminous flux	1100 - 1800 lm	1650 - 2800 lm	12500 - 18400 lm
LED colour	827, 830, 840, 930, 940	827, 830, 840, 930, 940	827, 830, 840, 930, 940
Dynamic colour	-	Tunable white 2700 - 6500K	Tunable white 2700 - 6500K
Driver	Casambi, DALI, FO	Casambi, DALI, FO	Casambi, DALI, FO
Emergency kit	EM 1h	EM 1h, EM 3h	EM 1h, EM 3h
IP protection	IP43 / IP40 (W)	IP43 / IP40 (W)	IP20
Colour	1 2	1 2	1 2

SH (mm): 1500, 3000, 5000

Dimensions

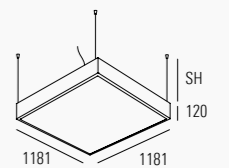
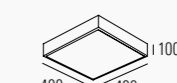
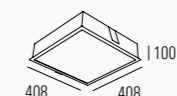
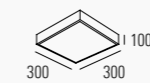
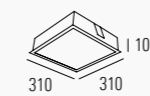

≥ 90 %



TW

GRO

CASAMBI



WARRANTY

CE



Light source: High-flux PCB LED modules, mid-power SMD LED, CRI>80/90, MacAdam≤2, 50.000h L90 B10 at 35°C. **Optic:** Satin opal PMMA diffuser (SOP) / Soft-light prismatic PMMA diffuser (DPR). **Body:** Aluminium, powder coated. / Steel-sheet, powder coated. **Control gear:** Integrated highly-efficient driver with fixed output (FO) or dimmable (DALI-TD, Casambi). Option of on/off microwave sensor. **Emergency:** Emergency kit version with autonomy 1h or 3h. **Power supply:** 230V 50Hz.

Svetlobni vir: PCB LED moduli visoke svetilnosti, z SMD LED, CRI>80/90, barvno odstopanje MacAdam≤2, 50.000 h L90 B10 na 35 °C. **Optika:** Satinirani opalni PMMA difuzor (SOP) / Mikro-prizmatična difuzna PMMA optika (DPR). **Ohišje:** Aluminij, prašno barvan. / Pločevina, prašno barvana. **Napajalnik:** Integriran visoko učinkoviti LED konverter s konstantnim tokom (FO) ali regulacijskim izhodom (DALI-TD, Casambi). Microwave senzor za FO konverter. **Varnostni modul:** Varnostni modul z 1 ali 3 urami avtonomije. **Napajanje:** 230 V 50 Hz.

Izvor svetla: PCB LED moduli velikog svetlosnog toka, SMD LED srednje snage, CRI>80/90, MacAdam≤2, 50.000 h L90 B10 na 35 °C. **Optika:** Satinirani opalni PMMA difuzor (SOP) / Mikroprizmatična difuzna PMMA optika (DPR). **Kućište:** Aluminijско, elektrostatski plastificirano. / Dekapirani čelik, elektrostatski plastificiran. **Predspojne naprave:** Integrirana visoko efikasna predspojna naprava konstantnog izlaza (FO) ili dimabilna (DALI-TD, Casambi). Mikrovalni senzor za FO konverter. **Režim nužne rasvjete:** Modul nužne rasvjete autonomije 1 ili 3 h. **Napajanje:** 230 V 50 Hz.



Etea

Advanced Basic

Details make the difference

The classic ceiling lamp has become so familiar, that hardly anyone would stop to consider how it can be improved. We said why not?

There was an empty space between looking too cheap and over designed. By taking away all the unnecessary, we've reached the most basic shape, great uniformity and improved modularity. Etea is well designed and affordable.

Detalji naredijo razliko

Klasična stropna svetilka je postala že tako vsakdanja, da je malokdo razmišljal o tem, kako jo izboljšati. Mi smo si rekli, zakaj pa ne?

Med svetili, ki izgledajo ceneno, in visoko dizajnerskimi, je zavezal prazen prostor. Odvzeli smo vse nepotrebno in dobili najbolj osnovno obliko, odlično enakomernost osvetlitve in izboljšano modularnost. Etea je dobro oblikovana in cenovno dostopna.

Pojednosti čine razliko

Klasična plafonjera postala je toliko uobičajena, da se rijetko promišlja o njenom razvoju. Mi smo rekli zašto ne?

Postojao je prazan prostor između prejeftinog izgleda i predizajnriranosti. Uklanjajući sve što nije neophodno, dosegli smo najosnovniji oblik, veliku ujednačenost i poboljšanu modularnost. Etea je dobro dizajnirana i pristupačna.





Etea

Technical Overview



	D Direct	DI Direct / Indirect	DF Diffused
Luminaire luminous flux	1100 - 1900 lm	1200 - 2050 lm	1150 - 1950 lm
LED colour	830, 840, 927, 930, 940	830, 840, 927, 930, 940	830, 840, 927, 930, 940
Driver	DALI, FO, Sensor	DALI, FO, Sensor	DALI, FO, Sensor
IP protection	IP43	IP43, IP65	IP43, IP65
Colour	1	1 2	1

Dimensions

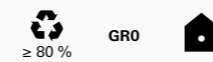
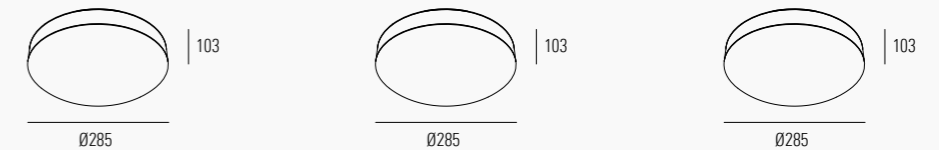

Light source: High-flux PCB LED modules, mid-power SMD LED, CRI>80/90, MacAdam≤2, 50.000h L90 B10 at 35°C. **Optic:** Opal polycarbonate diffuser (OP). **Body:** Polycarbonate. **Control gear:** Supplied with highly-efficient driver with fixed output (FO) or dimmable (DALI). Option of on/off microwave sensor. **Power supply:** 230V 50Hz.

Svetlobni vir: PCB LED moduli visoke svetilnosti, z SMD LED, CRI>80/90, barvno odstopanje MacAdam≤2, 50.000 h L90 B10 na 35 °C. **Optika:** Opalni polikarbonatni difuzor (OP). **Ohišje:** Polikarbonat. **Napajalnik:** Priložen visoko učinkoviti LED konverter s konstantnim tokom (FO) ali regulacijskim izhodom (DALI). Mikrovvalni senzor za FO konverter. **Napajanje:** 230 V 50 Hz.

Izvor svetla: PCB LED moduli velikog svetlosnog toka, SMD LED srednje snage, CRI>80/90, MacAdam≤2, 50.000 h L90 B10 na 35 °C. **Optika:** Opalni polikarbonatni difuzor (OP). **Kućište:** Polikarbonatno. **Predspojne naprave:** U kompletu s visoko učinkovitim LED konverterom s konstantnim tokom (FO) ili regulacijskim izlazom (DALI). Mikrovalni senzor za FO konverter. **Napajanje:** 230 V 50 Hz.



Vyko

Ec(h)o friendly

No noise. No glare. No pollution.

You can finally forget about those unaesthetic acoustic ceilings. Here is Vyko, an advanced all-in-one product, able to create various scenarios and personalized micro ambiances. Therefore, it is a perfect pick for offices and large open spaces.

3D ecofriendly acoustic panels are made from 100 % recyclable fibre, in order to guarantee an echo friendly acoustic performance. And above all things, it provides efficient homogeneous light distribution.

Brez hrupa. Brez bleščanja. Brez onesnaževanja.

Končno lahko pozabite na neestetske akustične stropove. Tukaj je Vyko, napreden izdelek, ki združuje vse v enem in lahko ustvari različne scenarije in osebno prilagojene mikroambiente. Zato je odlična izbira za pisarne ter velike odprte prostore.

3D okolju prijazne akustične plošče so izdelane iz 100 % recikliranih vlaken, da bi zagotovile prijazno akustiko brez odmevanja. Predvsem pa Vyko zagotavlja učinkovito homogeno porazdelitev svetlobe.

Bez buke. Bez odsjaja. Bez zagađenja.

Konačno možete zaboraviti na sve one neestet-ske akustične stropove. Ovdje je Vyko, napredni „sve-u-jednom“ proizvod, sposoban za kreiranje raznih scenarija i personaliziranih mikro-ambije-nata. Stoga je savršen izbor za urede i velike otvo-rene prostore.

3D akustični paneli su izrađeni od 100% recikliranih vlakana, kako bi osigurali dobru akustiku prostora. Iznad svega, Vyko jamči efikasnu i homogenu raspodjelu svjetlosti.









Made from **60%** recycled material (GR)

End of life: **100 % recyclable fibre**

The 4 central modules are illuminated

UGR <19

Glare control, high efficiency and visual comfort

Watch video

LFO VERSION

It's a luminaire. It's a ceiling. It improves the acoustics.

Acoustic ceiling with light or vice-versa? No matter how you define it, it solves three problems at once: improves the acoustics, offers high quality illumination with absolutely no glare and replaces the ceiling.



No, it's not off.

Are you wondering where the light comes from? With the Bartenbach LFO optic, Vyko illuminates the space pleasantly with low glare and without seeing the light source. It looks like it is off, but the light will be there.

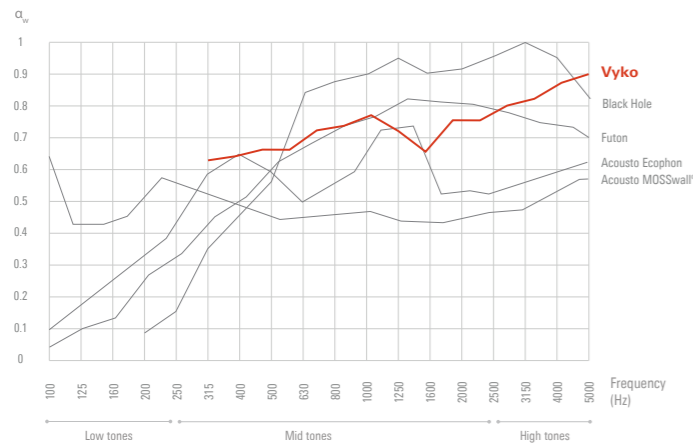

Maximum acoustic comfort

Vyko enables effective soundproofing and sound absorbing in all areas with higher frequencies.

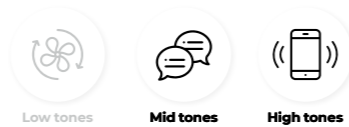

Three shades of grey

It's just a matter of taste and the feeling you want to create. Choose brighter tones for a more fresh, open appearance and optically higher ceilings.



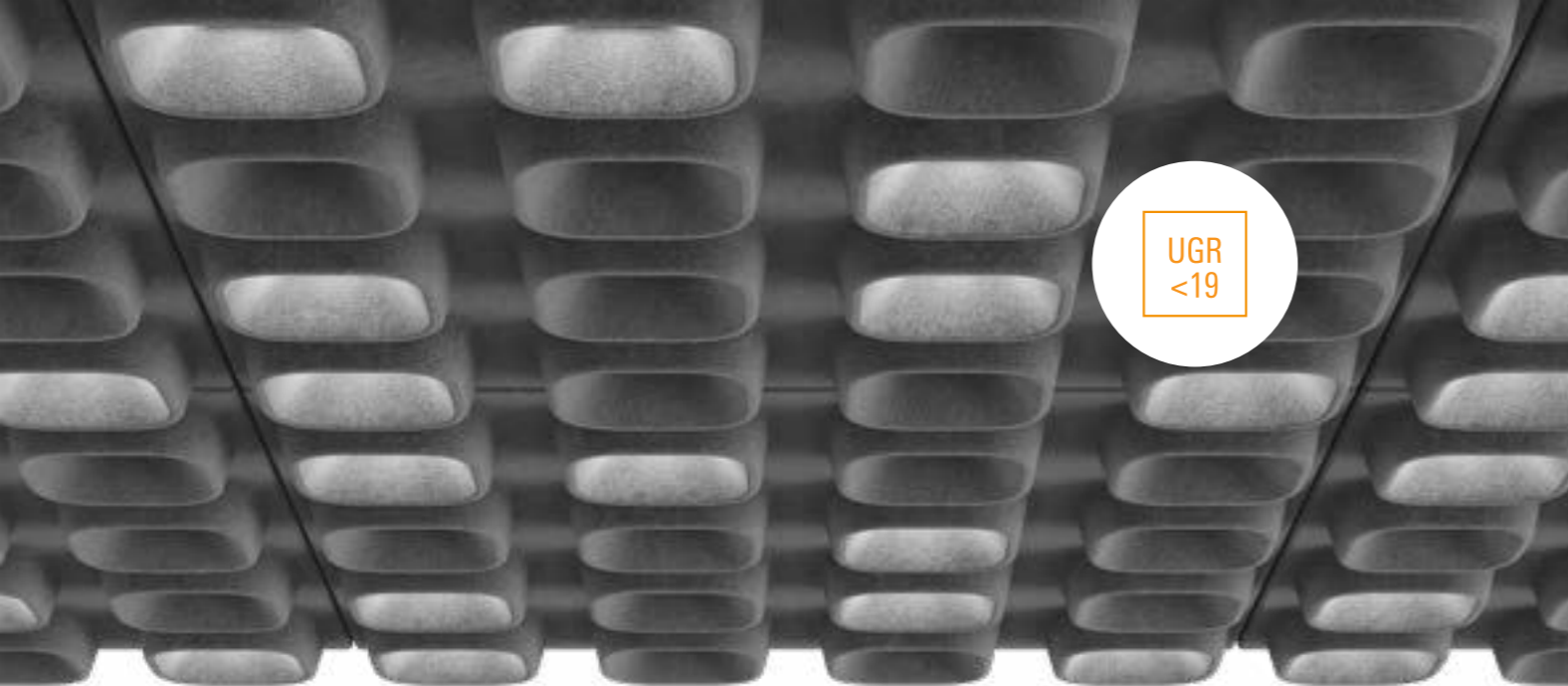

UGR
<19

Random patterns of light

No two layouts are the same, so each ceiling will be different, unique. Choose from different Deco versions or combine them with Vyko Dark.

DECO VERSION

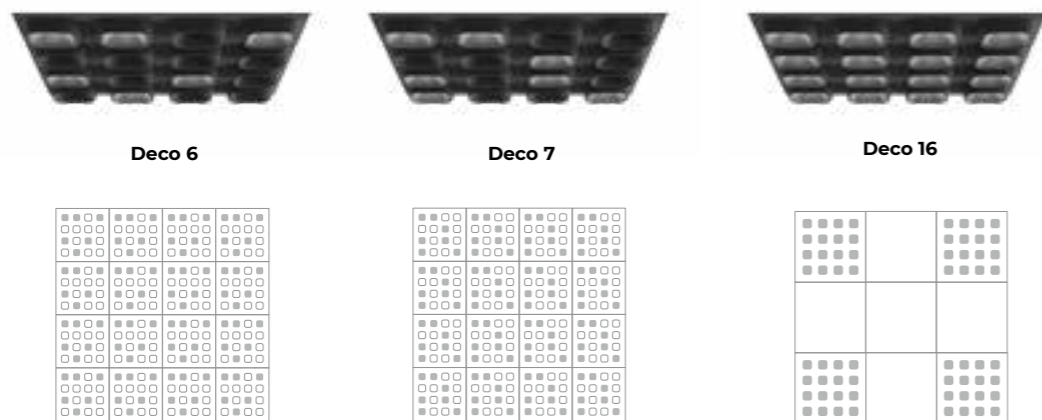

INSTALLATION TYPE

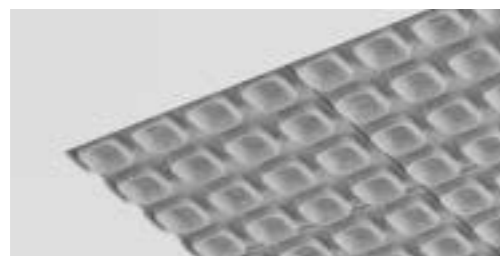

Click-in system with minimal distance between the panels and the ceiling.



Suspended installation with side profile.

Vyko

Technical Overview

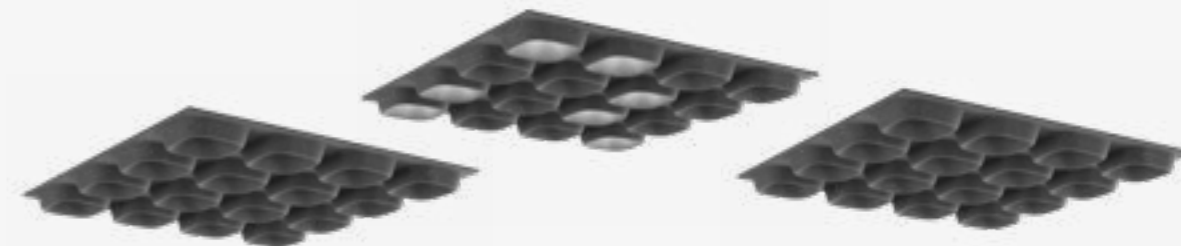

	LFO	DECO	DARK
Glare control	UGR<19	UGR<19	-
Optics	LFO 32°	Diffused	-
Luminaire luminous flux	660 lm	600 - 800 lm	-
N° of spots / panel	4	6, 8	-
LED colour	927, 930, 935, 940	927, 930, 935, 940	-
Driver	Casambi, DALI, FO	Casambi, DALI, FO	-
Driver position	Remote	Remote	-
Material	Thermoformed acoustic felt	Thermoformed acoustic felt	Thermoformed acoustic felt
Sound absorbing surface	0,6 m ²	0,6 m ²	0,6 m ²

Dimensions

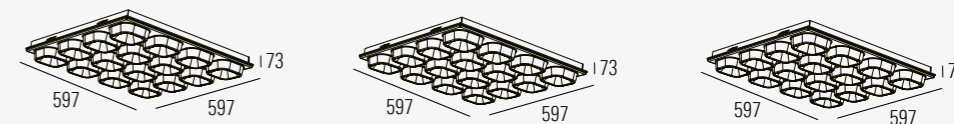

Colours: ▲ ▲ ▲



Light source: High-power COB LED, CRI>90, MacAdam≤2, 50.000h L90 B10 at 35°C. **Optic:** Acrylic glare-free LFO lens / Satined prismatic lens dome for uniform light distribution. **Body:** Thermoformed acoustic felt. **Control gear:** Integrated highly-efficient driver with fixed output (FO) or dimmable (DALI-TD, Casambi).

Svetlobni vir: Visoko učinkovit COB LED modul, CRI>90, barvno odstopanje MacAdam≤2, 50.000 h L90 B10 na 35 °C. **Optika:** Akrilna LFO leča brez bleščanja / Satinirana prizmatična kupola za enakomerno osvetlitev. **Ohišje:** Termoformirani akustični flis. **Napajalnik:** Integriran visoko učinkoviti LED konverter s konstantnim tokom (FO) ali regulacijskim izhodom (DALI-TD, Casambi).

Izvor svjetla: LED COB velike snage, CRI>90, MacAdam≤2, 50.000 h L90 B10 na 35 °C. **Optika:** LFO akrilna leča bez bliještanja / Satinirana prizmatična kupola za ravnomjernu osvijetljenost. **Kućište:** Termoformirani akustični flis. **Predspojne naprave:** Integrirana visoko efikasna predspojna naprava konstantnog izlaza (FO) ili dimabilna (DALI-TD, Casambi).



Skyler

The sky is the limit

Great design is transparent

Forget about boring office lights that reveal everything within one look! Here's Skyler and it's here to surprise! The first thing to wow is its see-through diffuser; invisible when the light is OFF, creating high visual comfort when the light is ON. And that's not the only thing that's beautiful. With its black and white frame colour combination and thinness, it's a true designer's piece, light years away from common office lighting solutions.

Skyler boasts the perfect combination of indirect and direct lighting, not only creating a feeling of spaciousness but also providing high-quality task illumination without any glare. Its additional options are an RGB or tunable white ambient illumination.

Dober dizajn je transparenten

Pozabite na dolgočasne pisarniške luči, ki v enem pogledu razkrijejo vse! Zdaj je tu Skyler, da vas preseneti. Najprej vas bo navdušil njegov transparentni difuzor; povsem neviden, ko je svetilka izključena, ko pa je prižgana, zagotavlja visoko vizualno udobje. Zaradi prefinjenosti okvirja v črno-beli kombinaciji lahko Skyler mirno umestimo med dizajnerska svetila, ki so svetlobna leta oddaljena od običajnih pisarniških luči.

Skyler se lahko pohvali s popolno kombinacijo direktne in indirektno osvetlitve, ki prostora ne le optično poveča, temveč zagotavlja tudi visokokakovostno osvetlitev brez bleščanja. Njegove dodatne možnosti so RGB ali osvetlitev z dinamično belo svetlobo.

Odličan dizajn je transparentan

Zaboravite na dosadna uredska svetla koja otkrivaju sve u jednom pogledu! Tu je Skyler, koji je došao iznenaditi! Prva stvar koja oduševljava je njegov prozirni difuzor; nevidljiv kada je svjetlo ugašeno, a stvarajući visoku vizualnu udobnost kada je svjetlo uključeno. I to nije ni jedina odlična stvar. Sa svojom crno-bijelom kombinacijom boja okvira i malom širinom, pravi je dizajnerski proizvod, svjetlosne godine udaljen od uobičajenih rješenja za uredsko osvjetljenje.

Skyler se može pohvaliti savršenom kombinacijom indirektno i direktne rasvjete, ne samo stvarajući osjećaj prostranosti, već i pružajući visokokvalitetno radno osvjetljenje bez ikakvog bliještanja. Njegove dodatne opcije su RGB ili dinamično bijelo ambijentalno osvjetljenje.





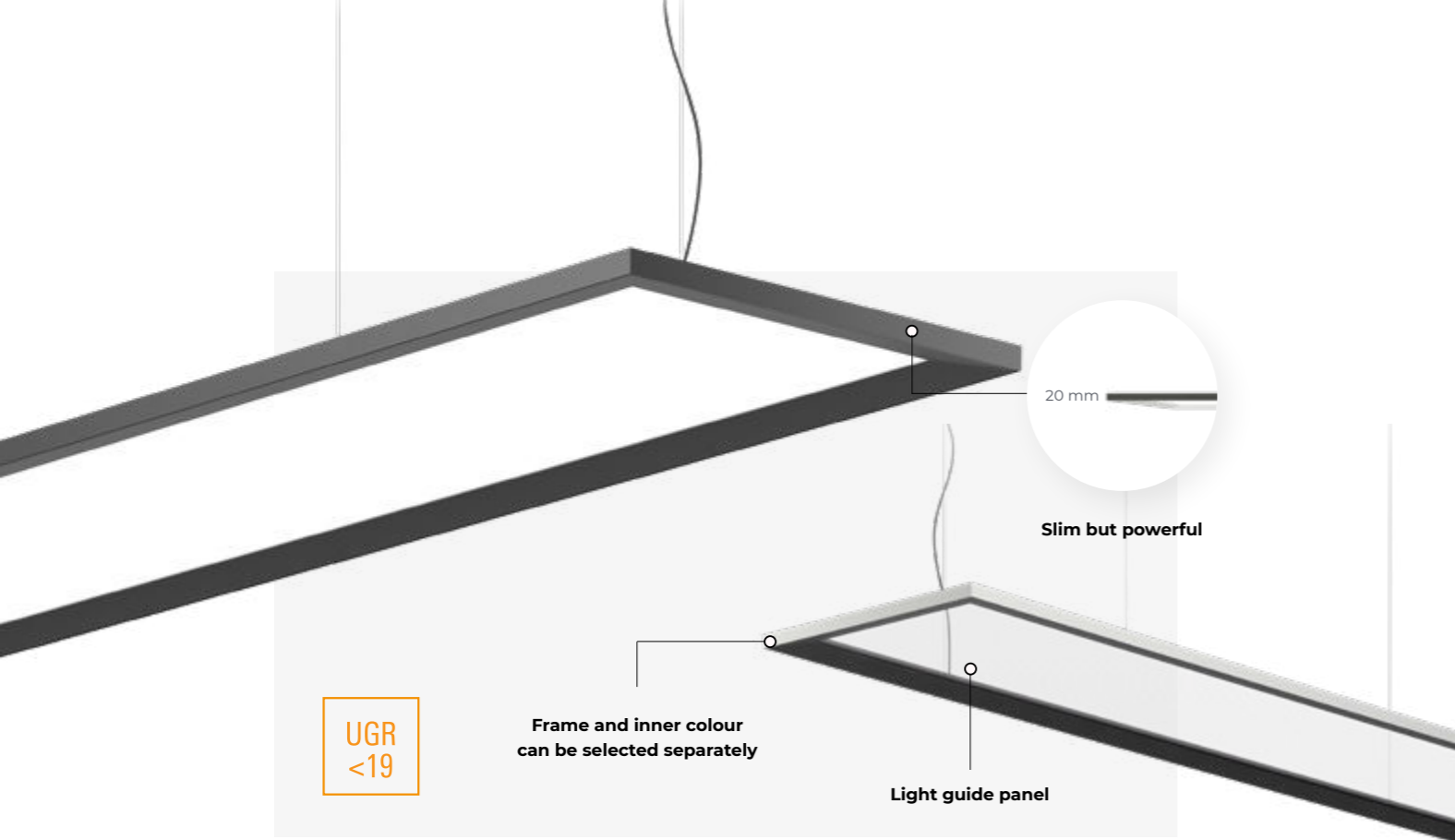

MAIN FEATURES

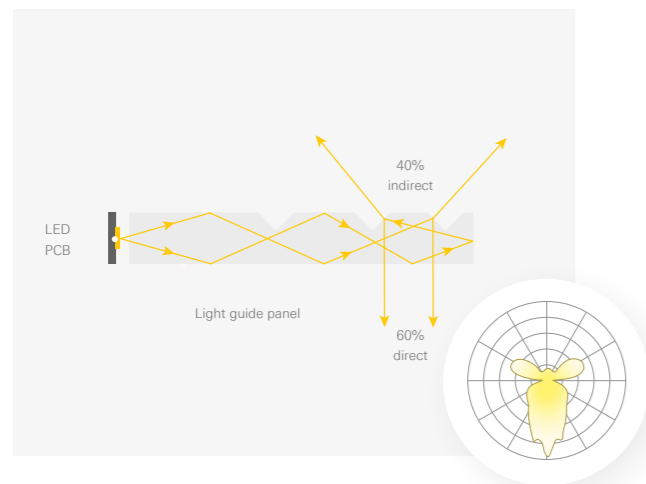

Light guide panel

Light guide panel provides uniform and homogeneous light output. A see-through plate is invisible when the light is off, or creates a high visual comfort when the light is on.



Extra indirect for extra effect

With the office changing needs, adapting the light to different activities and tasks is essential. Create dynamic lighting scenarios combining the basic direct / indirect illumination with additional, extra indirect RGB or tunable white illumination.

Skyler

Technical Overview



	SDI	SDI-A
	Suspended Direct / Indirect	Suspended Direct / Indirect with additional indirect TW or RGB
Glare control (UGR class)	UGR < 19	UGR < 19
Luminaire luminous flux	6400 - 6700 lm	6400 - 6700 lm
Additional indirect luminaire luminous flux	-	3100 lm (TW)
Light distribution	Direct / Indirect	Direct / Indirect
DLOR/ULOR	57% / 43%	57% / 43%
Optics	Light guide panel (LGP)	Light guide panel (LGP)
LED colour	930, 940	930, 940
Dynamic illumination (indirect only)	-	Tunable white 2700 - 6500K, RGB
Driver	Casambi, DALI, TD	Casambi, DALI, TD
Inner colour	B D	B D
Frame colour	B D H F Y	B D H F Y
Dimensions	SH (mm): 1500, 3000, 5000	SH (mm): 1500, 3000, 5000

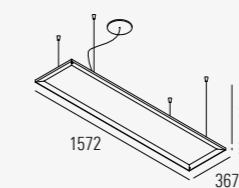

Straight suspension

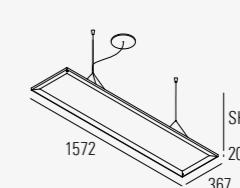

Y suspension

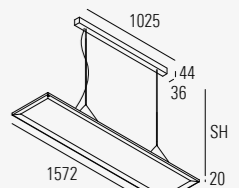

Y suspension



Light source: High-flux PCB LED modules, mid-power SMD LED, CRI>90, MacAdam≤2, 50.000h L90 B10 at 35°C. RGB or tunable white LED strip for ambient light. **Optic:** Acrylic (PMMA) light guide plate (LGP). **Body:** Extruded aluminium body and frame, powder or PVD coated. **Control gear:** LD ceiling cup versions are supplied with highly-efficient DALI dimmable drivers. For flat ceiling cup (RF) drivers must be ordered separately. **Power supply:** 230V 50Hz / 24V DC.

Svetlobni vir: High-flux PCB LED moduli, z SMD LED, CRI>90, MacAdam≤2, 50.000 h L90 B10 na 35 °C. RGB ali tunable white LED trak za ambientalno osvetlitev. **Optika:** Akrilna (PMMA) svetlobna vodilna plošča (LGP). **Ohišje:** Okvir in ohišje iz ekstrudiranega aluminija, prašno ali PVD barvano. **Napajalnik:** V rozeti integriran visoko učinkoviti LED konverter z regulacijskim izhodom (DALI). LED konverter s konstantnim tokom za ploščato rozeto - ločeno naročanje. **Napajanje:** 230 V 50 Hz / 24 V DC.

Izvor svetla: PCB LED moduli velikog svjetlosnog toka, SMD LED srednje snage, CRI>90, MacAdam≤2, 50.000 h L90 B10 na 35 °C. RGB ali tunable white LED trak za ambientalnu rasvjetu. **Optika:** Akrilna (PMMA) svjetlosno vodljiva ploča (LGP). **Kućište:** Okvir i kućište od ekstrudiranog aluminija, elektrostatski plastificiranog. **Predspojne naprave:** U rozeti integriran visoko učinkoviti LED konverter z regulacijskim izlazom (DALI). LED konverter s konstantnim tokom za pločastu rozetu - naručiti zasebno. **Napajanje:** 230 V 50 Hz / 24 V DC.



Tol

Mobile and personal

A standalone, installation-free luminaire

It brings light and electrical plugs directly to the table. It is robust yet still flexible enough to quickly fit in with the existing table arrangement, ready to start right away.

It is suitable for a single or double table setting, where the direct and indirect illumination is regulated separately. It brings uniformity, efficiency and a high visual comfort to the working environment. The presence sensor automatically switches it on or off.

Samostoječe svetilo brez montaže

Svetlobo in električne priključke pripelje direktno k pisalni mizi. To je robustno svetilo, a vseeno dovolj fleksibilno, da se hitro prilagodi obstoječi razporeditvi pohištva in lahko z delom lahko pričnete takoj.

Primerno je za eno ali dve delovni mesti, ob tem pa je možno direktno in indirektno osvetlitev regulirati ločeno. V delovnem prostoru svetilo zagotavlja enakomerno osvetlitev, učinkovitost in visoko vizualno udobje. Senzor prisotnosti ga avtomatsko prižiga ali ugaša.

Samostojeća rasvjeta, bez potrebe za ugradnjom

Donosi svjetlo i električne priključke izravno na stol. Robusno, a ipak dovoljno fleksibilno da se uklopi u postojeći aranžman stola, spremno početi odmah.

Prikladno je za pojedinačne ili dvostruke postavke stolova, gdje se izravna i neizravna rasvjeta zasebno reguliraju. Donosi ujednačenost, učinkovitost i visoki vizualni komfor radnom okružju. Senzor prisutnosti automatski uključuje i isključuje svjetiljku.



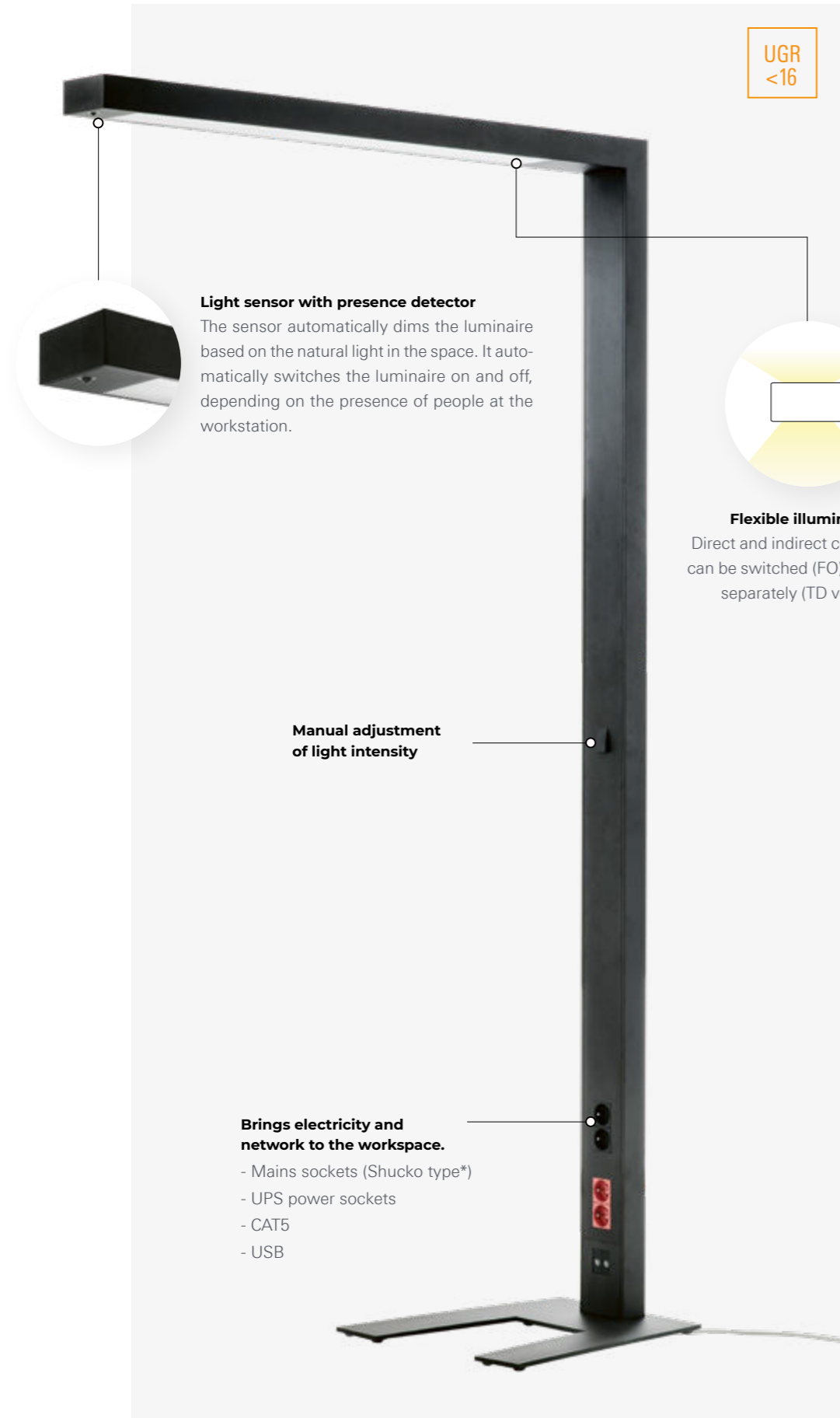

UGR
<16

Light sensor with presence detector

The sensor automatically dims the luminaire based on the natural light in the space. It automatically switches the luminaire on and off, depending on the presence of people at the workstation.

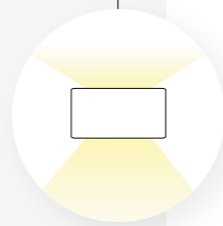

Flexible illumination

Direct and indirect components can be switched (FO) or dimmed separately (TD version).

Manual adjustment of light intensity

Brings electricity and network to the workspace.

- Mains sockets (Shucko type*)
- UPS power sockets
- CAT5
- USB

Tol

Technical Overview

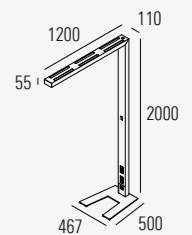

FAMILY MEMBER

TECH. SPECS

COLOURS

LUMINAIRE LUMINOUS FLUX	OPTICS	GLARE CONTROL	LED COLOUR	DRIVER
3200 - 5800 lm	DPR	UGR<16	827, 830, 840, 930, 940	DALI sensor, FO, TD

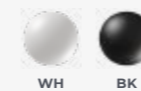

GR0



WARRANTY



Light source: High-flux PCB LED modules, mid-power SMD LED, CRI>80/90, MacAdam≤2, 50.000h L90 B10 at 35°C. **Optic:** Soft-light prismatic polycarbonate optics (DPR) for direct light and satin opal polycarbonate diffuser (SOP) for indirect light. **Body:** Extruded aluminium profile, powder coated. **Control gear:** Integrated highly-efficient driver with fixed output (FO) or dimmable (DALI sensor, TD). **Power supply:** 230V 50Hz.

Svetlobni vir: PCB LED moduli visoke svetilnosti, z SMD LED, CRI>80/90, barvno odstopanje MacAdam≤2, 50.000 h L90 B10 na 35 °C. **Optika:** Mikroprizmatična difuzna PMMA optika (DPR) za direktno osvetlitev in opalni polikarbonatni difuzor (SOP) za indirektno osvetlitev. **Ohišje:** Ekstrudiran profil iz aluminija, prašno barvan. **Napajalnik:** Integriran visoko učinkoviti LED konverter s konstantnim tokom (FO) ali regulacijskim izhodom (DALI senzor, TD). **Napajanje:** 230 V 50 Hz.

Izvor svetla: PCB LED moduli velikog svetlosnog toka, SMD LED srednje snage, CRI>80/90, MacAdam≤2, 50.000 h L90 B10 na 35 °C. **Optika:** Mikroprizmatična polikarbonatna optika za direktnu rasvjetu (DPR) i opalni polikarbonatni difuzor za indirektnu rasvjetu. **Kućište:** Ekstrudirani aluminijски profil, elektrostatski plastificiran. **Predspojne naprave:** Integrirana visoko efikasna predspojna naprava konstantnog izlaza (FO) ili dimabilna (DALI- senzor, TD). **Napajanje:** 230 V 50 Hz.



reddot design award
winner



Ergetic

All-in-one

Flexible illumination for changing needs

We are using the same space in many different ways. But what actually changes, when we switch between different activities? Normally nothing.

Ergetic was designed to challenge this fact. It is able to transform a space by changing the illumination and can adapt easily to your needs. By joining together different functions inside one single luminaire, it is a perfect solution for projects, where dynamic and flexible illumination is needed.

Prilagodljiva osvetlitev za spreminjajoče se potrebe

Isti prostor lahko uporabljamo za različne namene. Toda kaj se v resnici spremeni, ko preklapljam med različnimi aktivnostmi? Običajno nič.

V tem smo našli izziv za razvoj svetila Ergetic. S spremembo osvetlitve lahko namreč preobrazijo prostor in se zlahka prilagodi vašim potrebam. V enem samem svetilu so združene različne funkcije, zato je Ergetic najboljša rešitev za projekte, ki potrebujejo dinamično in prilagodljivo osvetlitev.

Fleksibilno osvetljenje za promjenjive potrebe

Isti prostor koristimo na puno različitih načina. Što se zapravo mijenja kad se prebacujemo među različitim aktivnostima? Obično ništa.

Ergetic je oblikovan da izazove ovu činjenicu. U stanju je transformirati prostor mijenjanjem osvjetljenja i može se lako prilagoditi vašim potrebama. Udružujući različite funkcije unutar jednog rasvjetnog tijela, kreirali smo savršeno rješenje za projekte u kojima je potrebna dinamička i fleksibilna rasvjeta.





Spot beam angle: 20°, 30°, 40°

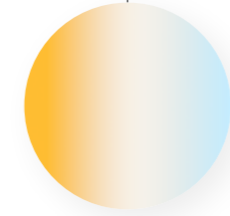

Tunable white



Dynamic back-light with RGB

MAIN FEATURES

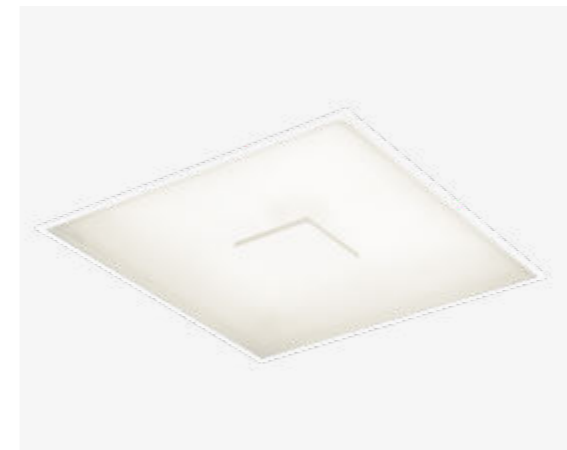

Dynamic illumination

Matching colour temperature and quantity of artificial light with daylight positively influences people's well-being.

3 in 1

With Ergetic you can provide many lighting scenarios with only one luminaire. Combining direct lighting, RGB and spotlight in different combinations you can adjust it to different needs and create different moods.



ONE PRODUCT FOR DIFFERENT SITUATIONS



Concentrated work

Direct light + spotlight
Finely tuned combination for situations when you need to focus and concentrate.



Collaboration and learning

RGB + spotlight
A vibrant lighting scenario with optimised brightness acts to energise.



Events and socializing

For socializing the light should be delivered at lower brightness and warmer white tones. By adding colour to light, entire space transforms and changes the way we feel.

Ergetic

Technical Overview

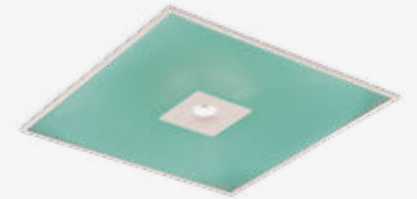
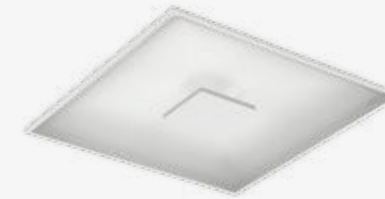

DIRECT + RGB

DIRECT + SPOT + RGB

	DIRECT + RGB	DIRECT + SPOT + RGB	Spot
Optics	SOP	SOP	20°, 30°, 40°
Luminaire luminous flux	4200- 6200 lm	4200- 6200 lm	1700 - 2350 lm
LED colour	830, 840, 930, 940	830, 840, 930, 940	830, 840, 930, 940
Dynamic colour	Tunable white 2700 - 6500K	Tunable white 2700 - 6500K	-
Driver	Casambi, DALI, FO	Casambi, DALI, FO	Casambi, DALI, FO
Dimensions	L (mm): 597, 622	L (mm): 597, 622	

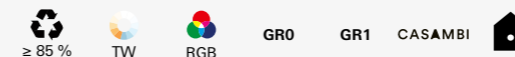
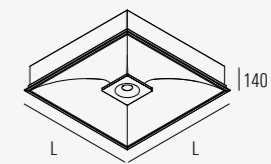
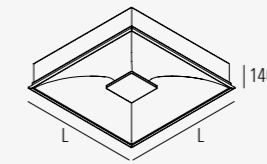

Light source: High-flux PCB LED modules, mid-power SMD LED, CRI>80/90, MacAdam≤2, 50.000h L90 B10 at 35°C. / High-power COB LED module, CRI>80/90, MacAdam≤2, 50.000h L80 B10 at 35°C for spot light. / RGB LED for ambient light. **Optic:** Opal acrylic diffuser for direct light; highly efficient uniform distribution, metalized polycarbonate with lacquer finish optic for spot light. **Body:** Steel-sheet housing with aluminium frame. **Control gear:** Integrated highly-efficient driver with fixed output (FO-DS) or dimmable (DALI-DS, Casambi) - separate switching. RGB component require external driver and controller - order separately. **Power supply:** 230V 50Hz.

Svetlobni vir: PCB LED moduli visoke svetilnosti, z SMD LED, CRI>80/90, barvno odstopanje MacAdam≤2, 50.000 h L90 B10 na 35 °C. / Visoko učinkovit COB LED modul, CRI>80/90, barvno odstopanje MacAdam≤2, 50.000 h L80 B10 na 35 °C za akcentno osvetlitev. / RGB LED za ambientalno osvetlitev. **Optika:** Opalni akrilni difuzor za direktno osvetlitev; visoko učinkovit metaliziran in lakiran polikarbonat z enakomerno porazdelitvijo svetlobnega snopa za akcentno osvetlitev. **Ohišje:** Pločevinasto ohišje z aluminijastim okvirjem. **Napajalnik:** Integriran visoko učinkoviti LED konverter s konstantnim tokom (FO-DS) ali regulacijskim izhodom (DALI-DS, Casambi) - ločeno prižiganje. RGB komponenta zahteva zunanji konverter in kontroler - ločeno naročanje. **Napajanje:** 230 V 50 Hz.

Izvor svetla: PCB LED moduli velikog svetlosnog toka, SMD LED srednje snage, CRI>80/90, MacAdam≤2, 50.000 h L90 B10 na 35 °C. / LED COB velike snage, CRI>80/90, MacAdam≤2, 50.000 h L80 B10 na 35 °C za akcentnu rasvjetu. / RGB LED ZA ambijentalnu rasvjetu. **Optika:** Pokrov direktne komponente opalni akrilni difuzor; visoko učinkovita jednolikost distribucije. **Kućište:** Kućište iz dekapiranog čelika s okvirom od ekstrudiranog aluminija, elektrostatski plastificirano. **Predspojne naprave:** Integrirana visoko efikasna predspojna naprava konstantnog izlaza (FO-DS) ili dimabilna (DALI-DS, Casambi). Odvojeno paljenje. RGB komponenta treba vanjski konverter i kontroler - naručiti zasebno. **Napajanje:** 230 V 50 Hz.



Canvas

Out of the box

Only Canvas succeeded in de-boxing a light box

This is a solution for those who want colour, form and function combined in a distinctive and elegant luminaire with a high visual comfort.

By placing the aesthetic accent on the frame, the contrast between lit and non-lit surfaces is softened and the perception of depth is changed. For fixture personalization, colour is introduced, while different sizes allow you to play with a variety of combinations.

Samo svetilu Canvas je uspelo stopiti iz okvirjev

To je rešitev za vse, ki želite kombinacijo barve, oblike in funkcionalnosti v posebnem elegantnem svetilu z visokim vizualnim udobjem.

Estetski poudarek je na okvirju, tako da je prehod med osvetljenimi in neosvetljenimi površinami mehkejši, občutek globine pa je povsem drugačen. Za personalizirane rešitve so na voljo barve, različne dimenzije pa omogočajo, da se lahko poigrate s številnimi kombinacijami.

Samo je Canvas uspio izbaciti svetlosne kutije izvan okvira

Rješenje za one koji žele boju, formu i funkciju uključenje u jedinstvenoj, elegantnoj svjetiljci visokog vizualnog komfora.

Postavljajući estetski naglasak na okvir, kontrast između osvijetljenih i neosvijetljenih površina se ublažava, a doživljaj dubine se mijenja. Varijacije boja dopuštaju prilagođavanje svjetiljke vlastitim potrebama, dok različite dimenzije omogućuju kreiranje raznih kombinacija.



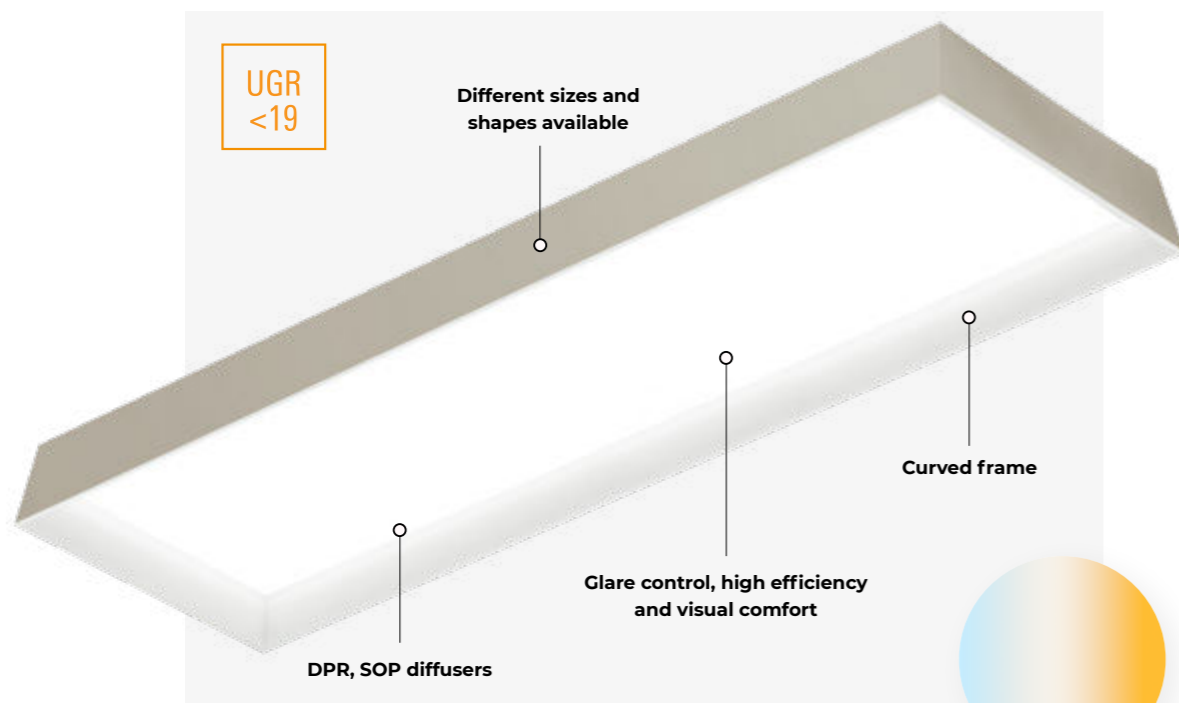

MAIN FEATURES



Soft light transition

The curved frame softens the contrast between lit and non-lit surfaces.

Dual colour, excellent light quality

Combine colour, form and function in a distinctive and elegant look. Glare control, maximum efficiency and high uniformity result in outstanding visual comfort.



Canvas

Technical Overview



CANVAS R Recessed

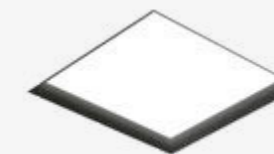

M600 / M625

CANVAS C/S Ceiling / Suspended



C only

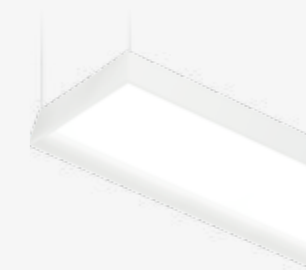

	350x350	600x600	350x1100
Optics	SOP, DPR	SOP, DPR	SOP, DPR
Glare control	UGR<19 (DPR)	UGR<19 (DPR)	UGR<19 (DPR)
Luminaire luminous flux	830 - 1500 lm	3200 - 5800 lm	3200 - 5800 lm
LED colour	830, 840, 930, 940	830, 840, 930, 940	830, 840, 930, 940
Dynamic colour	-	Tunable white 2700 - 6500K	Tunable white 2700 - 6500K
Driver	Casambi, DALI, FO	Casambi, DALI, FO	Casambi, DALI, FO
Emergency kit	-	EM 1h, EM 3h	EM 1h, EM 3h
Colour	1 2 3	1 2 3	1 2 3

Dimensions

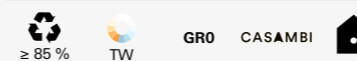
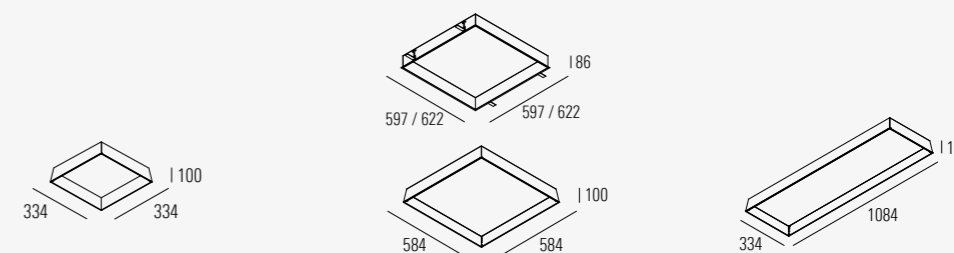

Light source: High-flux PCB LED modules, mid-power SMD LED, CRI>80/90, MacAdam≤2, 50.000h L90 B10 at 35°C. **Optic:** Satin opal PMMA diffuser (SOP) / Soft-light prismatic PMMA diffuser (DPR). **Body:** Steel-sheet housing with aluminium frame. / Extruded aluminium profile, powder coated. **Ceiling cup:** For suspended versions, the ceiling cup and suspension set must be ordered separately. Find out more on the technical pages or online product configurator. **Control gear:** Integrated highly-efficient driver with fixed output (FO) or dimmable (DALI-TD, Casambi). **Emergency:** Emergency kit version with autonomy 1h or 3h. **Power supply:** 230V 50Hz.

Svetlobni vir: PCB LED moduli visoke svetilnosti, z SMD LED, CRI>80/90, barvno odstopanje MacAdam≤2, 50.000 h L90 B10 na 35 °C. **Optika:** Satinirani opalni PMMA difuzor (SOP) / Mikro-prizmatična difuzna PMMA optika (DPR). **Ohišje:** Pločevinasto ohišje z aluminijastim okvirjem. / Ekstrudiran profil iz aluminija, prašno barvan. **Stropna rozeta:** Za viseče verzije se rozete in vešala naročajo posebej. Več na straneh s tehnično vsebino ali v spletnem konfiguratorju. **Napajalnik:** Integriran visoko učinkoviti LED konverter s konstantnim tokom (FO) ali regulacijskim izhodom (DALI-TD, Casambi). **Varnostni modul:** Varnostni modul z 1 ali 3 urami avtonomije. **Napajanje:** 230 V 50 Hz.

Izvor svetla: PCB LED moduli velikog svetlosnog toka, SMD LED srednje snage, CRI>80/90, MacAdam≤2, 50.000 h L90 B10 na 35 °C. **Optika:** Satinirani opalni PMMA difuzor (SOP) / Mikroprizmatična difuzna PMMA optika (DPR). **Kućište:** Kućište iz dekapiranog čelika s okvirom od ekstrudiranog aluminija, elektrostatski plastificirano. / Ekstrudirani aluminij-ski profil, elektrostatski plastificiran. **Stropna rozeta:** Za ovesne inačice, stropna rozeta i ovesni pribor moraju biti naručeni zasebno. Otkrij više na tehničkim stranicama ili online konfiguratoru proizvođača. **Predspojne naprave:** Integrirana visoko efikasna predspojna naprava konstantnog izlaza (FO) ili dimabilna (DALI-TD, Casambi). **Režim nužne rasvjete:** Modul nužne rasvjete autonomije 1 ili 3 h. **Napajanje:** 230 V 50 Hz.



Demi

Office reviver

Full flexibility of space arrangement

Demi represents a high quality lighting solution for office buildings. It provides maximum efficiency and a uniform illumination everywhere.

It's perfect for areas, where you need maximum flexibility of space arrangement or when the final layout is not yet known. The universal luminaire body can be installed in plasterboard or modular ceilings, ensuring the best match with the interior space design.

Popolna prilagodljivost pri urejanju prostora

Demi je namenjen visokokakovostni razsvetljavi poslovnih stavb. Zagotavlja maksimalno učinkovitost in enakomerno osvetlitev.

Je odlična izbira za površine, kjer potrebujete veliko prilagodljivosti pri urejanju prostora, ali takrat ko končni izgled še ni znan. Univerzalno ohišje svetila je lahko vgrajeno v mavčne ali modularne stropove, pri čemer zagotavlja popolno ujemanje z notranjo ureditvijo prostora.

Potpuna fleksibilnost uređenja prostora

Demi predstavlja visoko kvalitetno rješenje rasvjete za poslovne objekte. Pruža maksimalnu učinkovitost i ravnomjernu rasvijetlnost.

Savršena je za područja u kojima trebate maksimalnu fleksibilnost uređenja prostora ili kad konačni izgled još nije poznat. Univerzalno rasvjetno tijelo može biti ugrađeno u gipsane ploče ili modularne stropove, osiguravajući najbolju usklađenost s dizajnom prostora interijera.







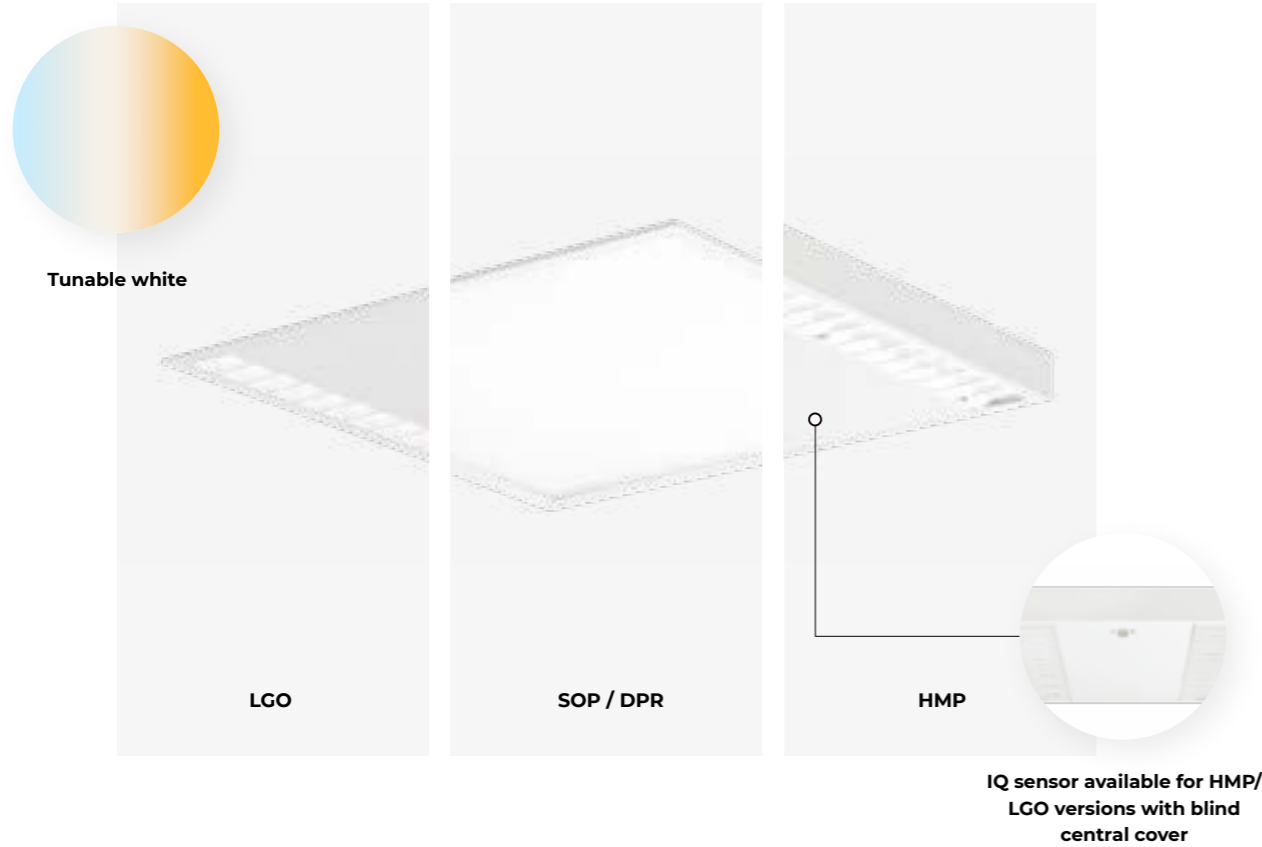

DYNAMIC OFFICE LIGHTING



High visual comfort in your office

Demi offers optimized optics, glare control and excellent light quality. The optic provides soft light that allows glare-free use of any kind of displays. Satin opal (SOP) is for general illumination and soft-light prismatic optics (DPR) is for controlled LED luminance.

UGR <16



Activating and motivating

Office lighting can be adjusted in a way to activate and stimulate workers or help keep them focused when there is need for concentrated work.

Designed for bandrastrer and climate ceilings

Demi R AIR is designed for bandrastrer rail profile ceilings, with air caps allowing air to flow between the housing and reflector.

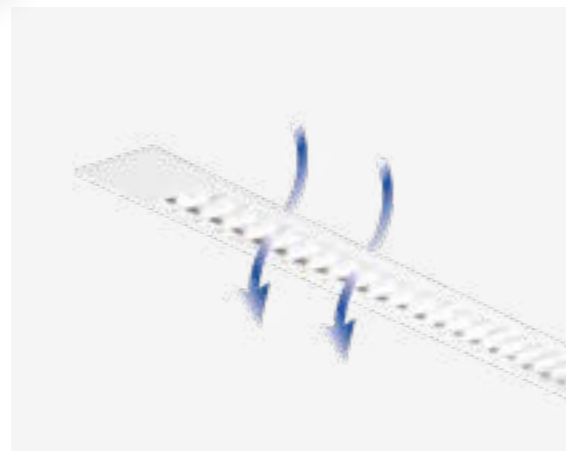

Relaxing lighting scenario

Light can also ease stressful situations enabling workers to perform better. People's well-being can be additionally enhanced by matching the colour temperature and quantity of artificial light with daylight.



Demi

Technical Overview



RV



C, SDI



	LGO Low glare optic	SOP / DPR Satin opal diffuser / Soft-light prismatic diffuser	C, RV ALUMINIUM LOUVRE Satin silver coated aluminium louvre	HMP AIR Satin silver coated aluminium louvre with air slots	SDI HMP Satin silver coated aluminium louvre
Optics	LGO	SOP, DPR	HMP	HMP	HMP
Glare control	UGR<16 (LGO B60 597x597) UGR<19 (other versions 597x597)	UGR<16 (DPR 2000 lm 597x597) UGR<19 (DPR 3600 lm 597x597)	UGR<16 (HMP 2050 lm 597x597) UGR<19 (HMP 3400 lm 597x597)	UGR<16 (HMP AIR 2550 lm 150x1699) UGR<19 (HMP AIR 4200 lm 150x1699)	UGR<16
Luminance (at 65°)	L<200 cd/m ² (LGO B60 2200 lm)	L < 1000 cd/m ² * / 2000 cd/m ² **	L < 200 cd/m ²	L < 200 cd/m ²	L < 200 cd/m ²
Luminaire luminous flux	2115 - 3451 lm	1900 - 5300 lm	1900 - 6500 lm	2400 - 4200 lm	4900 - 8500 lm
LED colour	930, 940	830, 840, 930, 940	830, 840, 930, 940	830, 840, 930, 940	830, 840, 930, 940
Dynamic colour	Tunable white 2700 - 6500K	Tunable white 2700 - 6500K	Tunable white 2700 - 6500K	Tunable white 2700 - 6500K	-
Driver	DALI, FO	Casambi, DALI, FO	Casambi, DALI, FO	Casambi, DALI, FO	Casambi, DALI, FO
Emergency kit	EM 1h, EM 3h	EM 1h, EM 3h	EM 1h, EM 3h	EM 1h, EM 3h	-
IP protection	IP20	IP43, IP44, IP55	IP20	IP20	IP20

Dimensions	L (mm): 297, 597 (RV), 306, 586 (C)	L (mm): 597, 622 WxL1 (mm): 197/297x1197, 297x1497, 309x1247	L (mm): 597, 622 WxL1 (mm): 115/198/297x1197, 309x1247, 100/150x1699, 100/150x1720	WxL (mm): 100x1699 /1720, 150x1699/1720	
-------------------	-------------------------------------	---	--	---	--

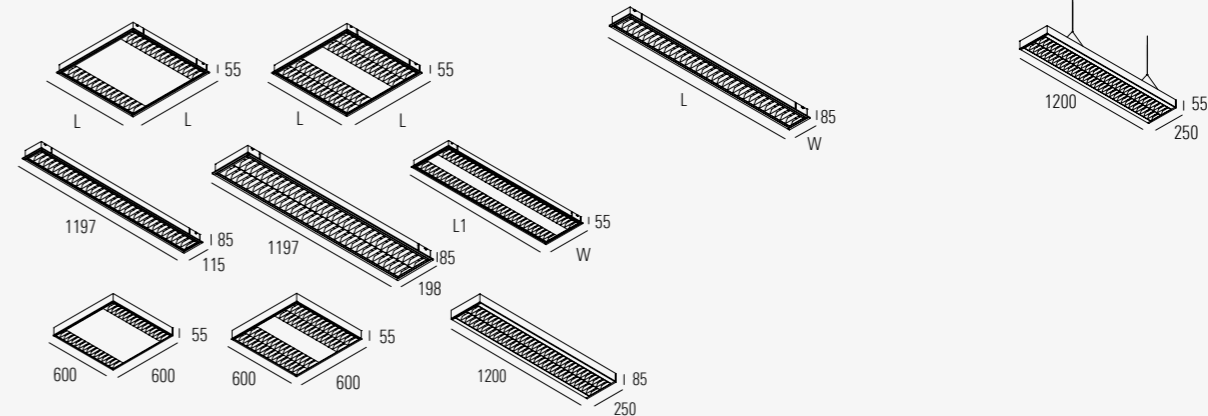
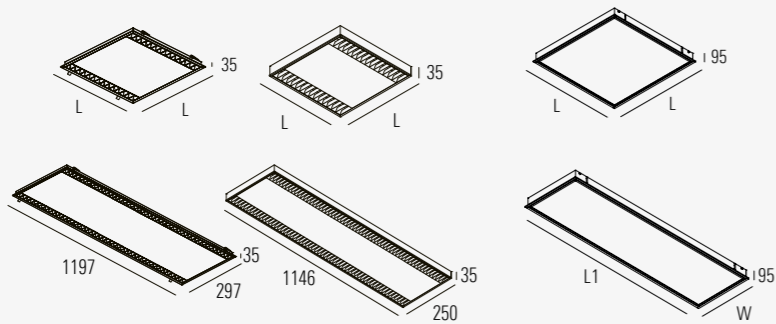

* DPR 2000 lm 597x597 ** DPR 3600 lm 597x597

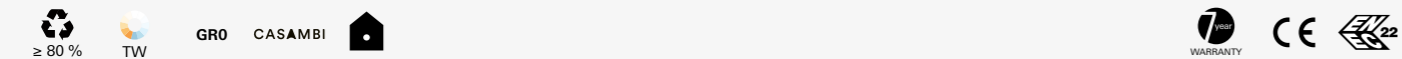

Light source: High-flux PCB LED modules, mid-power SMD LED, CRI>80/90, MacAdam≤2, 50.000h L90 B10 at 35°C. **Optic:** Satin opal PMMA diffuser (SOP), Soft-light prismatic PMMA diffuser (DPR), Satin silver-coated aluminium double parabolic louvre (HMP). **Body:** Steel-sheet, powder coated. **Ceiling cup:** For suspended versions, the ceiling cup and suspension set must be ordered separately. Find out more on the technical pages or online product configurator. **Control gear:** Integrated highly-efficient driver with fixed output (FO) or dimmable (DALI-TD, Casambi). **Emergency:** Emergency kit version with autonomy 1h or 3h. **Power supply:** 230V 50Hz.

Svetlobni vir: PCB LED moduli visoke svetilnosti, z SMD LED, CRI>80/90, barvno odstopanje MacAdam≤2, 50.000 h L90 B10 na 35 °C. **Optika:** Satinirani opalni PMMA difuzor (SOP), Mikro-prizmatična difuzna PMMA optika (DPR), Dvojna parabolična optika iz visoko odsevnega satiniranega posrebrnega aluminija (HMP). **Ohišje:** Pločevina, prašno barvana. **Stropna rozeta:** Za viseče verzije se rozete in vešala naročajo posebej. Več na straneh s tehnično vsebino ali v spletnem konfiguratorju. **Napajalnik:** Integriran visoko učinkoviti LED konverter s konstantnim tokom (FO) ali regulacijskim izhodom (DALI-TD, Casambi). **Varnostni modul:** Varnostni modul z 1 ali 3 urami avtonomije. **Napajanje:** 230 V 50 Hz.

Izvor svetla: PCB LED moduli velikog svetlosnog toka, SMD LED srednje snage, CRI>80/90, MacAdam≤2, 50.000 h L90 B10 na 35 °C. **Optika:** Satinirani opalni PMMA difuzor (SOP), Mikroprizmatična difuzna PMMA optika (DPR), Dvostruko parabolični raster od satiniranog aluminija parenog srebrrom (HMP). **Kućište:** Dekapirani čelik, elektrostatski plastificiran. **Stropna rozeta:** Za ovjesne inačice, stropna rozeta i ovjesni pribor moraju biti naručeni zasebno. Otkrij više na tehničkim stranicama ili online konfiguratoru proizvođača. **Predspojne naprave:** Integrirana visoko efikasna predspojna naprava konstantnog izlaza (FO) ili dimabilna (DALI-TD, Casambi). **Režim nužne rasvjete:** Modul nužne rasvjete autonomije 1 ili 3h. **Napajanje:** 230 V 50 Hz.



106 & 216

Basic light box

A simple decision when the budget is tight

The 106/216 product range is a functional and accessible range, which is suitable when you are looking for something basic with an optimal ratio of price, uniformity and light output.

It's an affordable alternative to the classic light box. It can be installed in a few minutes and is available in many shapes and mounting options.

Preprosta odločitev ob nizkem proračunu

Niz svetil 106/216 je funkcionalna in zelo dostopna kolekcija, posebej primerna takrat, ko iščete nekaj osnovnega z dobrim razmerjem med ceno, enakomernostjo osvetlitve in svetlobnim učinkom.

Je dostopna alternativa klasičnim vgradnim svetilom za modularne strope. Instalacija traja le nekaj minut. Na voljo je veliko različnih oblik in načinov vgradnje.

Jednostavno rješenje za ograničen budžet

Raspon proizvoda 106/216 je funkcionalan i pristupačan, nudeći optimalan omjer cijene, ujednačene distribucije svjetla i efikasnosti rasvjete.

To je prihvatljiva alternativa klasičnom svjetlosnom rasteru. Može se ugraditi za nekoliko minuta i dostupna je u mnogo oblika i načina ugradnje.



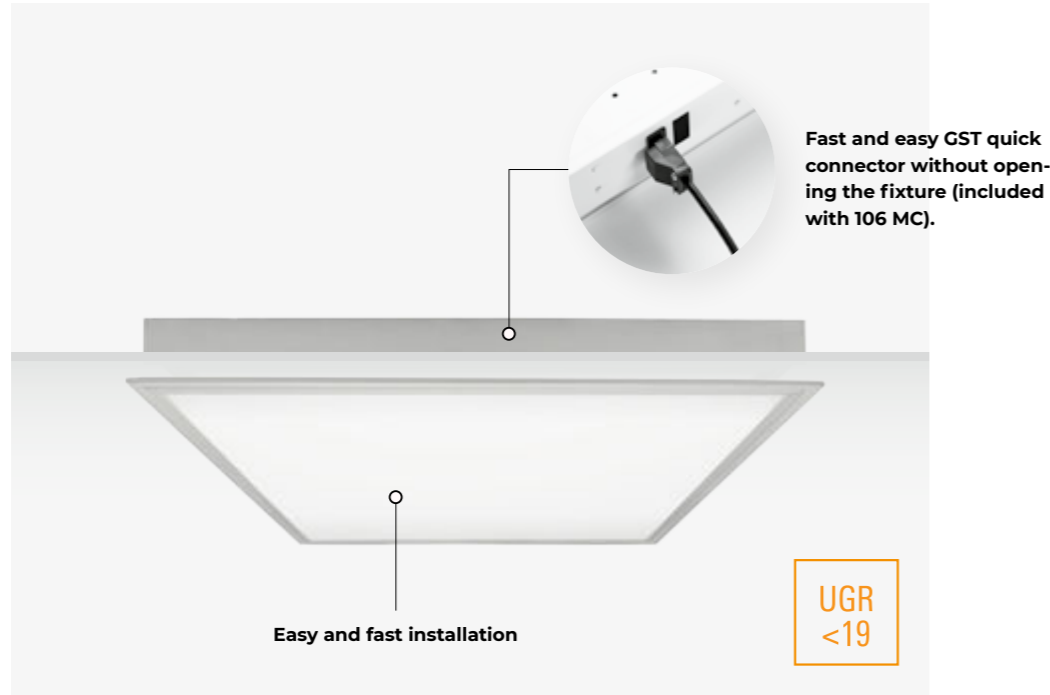

MAIN FEATURES



106 MC for modular ceilings

It is available in two standard shapes for modular ceilings. It's easy to install with no need to open the fixture. GST quick connector is included.

Different optic types

Diffused prismatic diffuser (DPR)* with UGR<19. Prismatic diffuser (PR) with UGR<19. Opal diffuser (OP).

*Only for MC version.

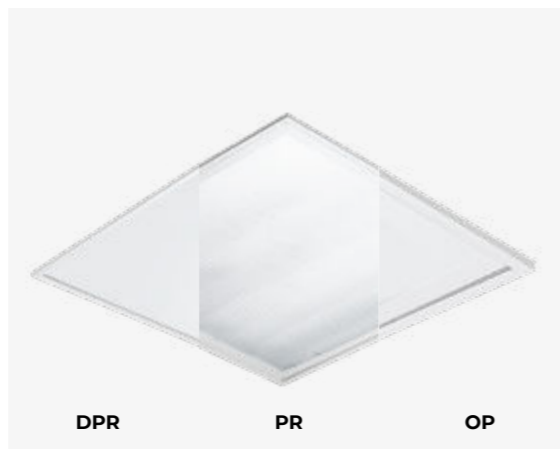

106 & 216

Technical Overview



	106 MC	106	216
Optics	DPR, OP, PR	OP, PR	OP, PR
Glare control	UGR<19 (DPR, PR)	UGR<19 (PR)	UGR<19 (PR)
Luminaire luminous flux	2050 - 5300 lm	1650 - 4900 lm	1550 - 4800 lm
LED colour	830, 840, 930, 940	830, 840, 930, 940	830, 840, 930, 940
Driver	Casambi, DALI,FO	Casambi, DALI,FO	Casambi, DALI,FO
Emergency kit	EM 1h, EM 3h	EM 1h, EM 3h	EM 1h, EM 3h
IP protection	IP43	IP43, IP44, IP55	IP43
Dimensions		L (mm): 597, 622 WxL (mm): 197/297x1197 / 309x1247	

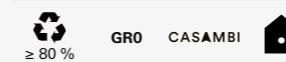
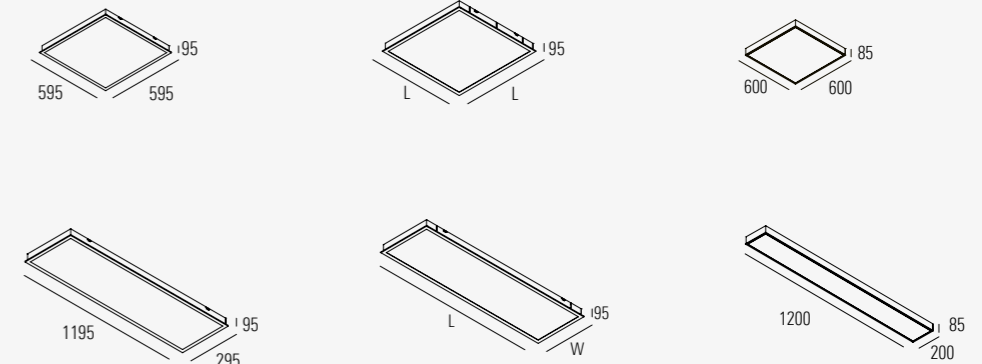

Light source: High-flux PCB LED modules, mid-power SMD LED, CRI>80/90, MacAdam≤2, 50.000h L90 B10 at 35°C. **Optic:** Opal PMMA diffuser (OP), Prismatic PMMA difuzor (PR), Soft-light prismatic PMMA diffuser (DPR). **Body:** Steel-sheet, powder coated. **Control gear:** Integrated highly-efficient driver with fixed output (FO) or dimmable (DALI-TD, Casambi). **Emergency:** Emergency kit version with autonomy 1h or 3h. **Power supply:** 230V 50Hz.

Svetlobni vir: PCB LED moduli visoke svetilnosti, z SMD LED, CRI>80/90, barvno odstopanje MacAdam≤2, 50.000 h L90 B10 na 35 °C. **Optika:** Opalni PMMA difuzor (OP), Prizmatični PMMA difuzor (PR), Mikro-prizmatična difuzna PMMA optika (DPR). **Ohišje:** Pločevina, prašno barvana. **Napajalnik:** Integriran visoko učinkoviti LED konverter s konstantnim tokom (FO) ali regulacijskim izhodom (DALI-TD, Casambi). **Varnostni modul:** Varnostni modul z 1 ali 3 urami avtonomije. **Napajanje:** 230 V 50 Hz.

Izvor svetla: PCB LED moduli velikog svetlosnog toka, SMD LED srednje snage, CRI>80/90, MacAdam≤2, 50.000 h L90 B10 na 35 °C. **Optika:** Opalni PMMA difuzor (OP), Prizmatični PMMA difuzor (PR), Mikroprizmatična difuzna PMMA optika (DPR). **Kućište:** Dekapirani čelik, elektrostatski plastificiran. **Predspojne naprave:** Integrirana visoko efikasna predspojna naprava konstantnog izlaza (FO) ili dimabilna (DALI-TD, Casambi). **Režim nužne rasvjete:** Modul nužne rasvjete autonomije 1 ili 3h. **Napajanje:** 230 V 50 Hz.



Alkon

Clean room choice

The right performance in medical care and industrial settings

Alkon efficiently integrates the clean room design, functionality and the quality of illumination. It brings a uniform light distribution to a room, always perfectly suited to various activities and visual tasks.

The product is available in different shapes and mounting possibilities. With a surface design that minimizes the accumulation of dirt and IP65 protection class, it offers an efficient solution in areas with extra protection requirements.

Prava rešitev za zdravstveno nego in industrijske obrate

Alkon učinkovito združuje dizajn za čiste prostore, funkcionalnost in kakovost osvetlitve. V prostor prinaša enakomerno porazdelitev svetlobe, ki povsem ustreza različnim aktivnostim in vizualnim zahtevam.

Svetilo je na voljo v različnih oblikah in z različnimi možnostmi vgradnje. Z obliko površine, ki preprečuje nabiranje umazanije, in zaščito razreda IP65, je Alkon smiselna rešitev za prostore z zelo visokimi potrebami po zaščiti.

Prave performanse u zdravstvenoj skrbi i industrijskim prostorima

Alkon učinkovito integrira dizajn za potrebe čiste sobe, funkcionalnost i kvalitetno osvetljenje. Donosi ujednačenu distribuciju svetla u prostor, uvijek savršeno prilagođenu raznim djelatnostima i vizualnim zadacima.

Proizvod je dostupan u različitim oblicima i mogućnostima ugradnje. S formom koja minimizira nakupljanje nečistoća, te mehaničkom zaštitom IP65, svjetiljka je učinkovito rješenje za područja sa zahtjevima za posebnom zaštitom.



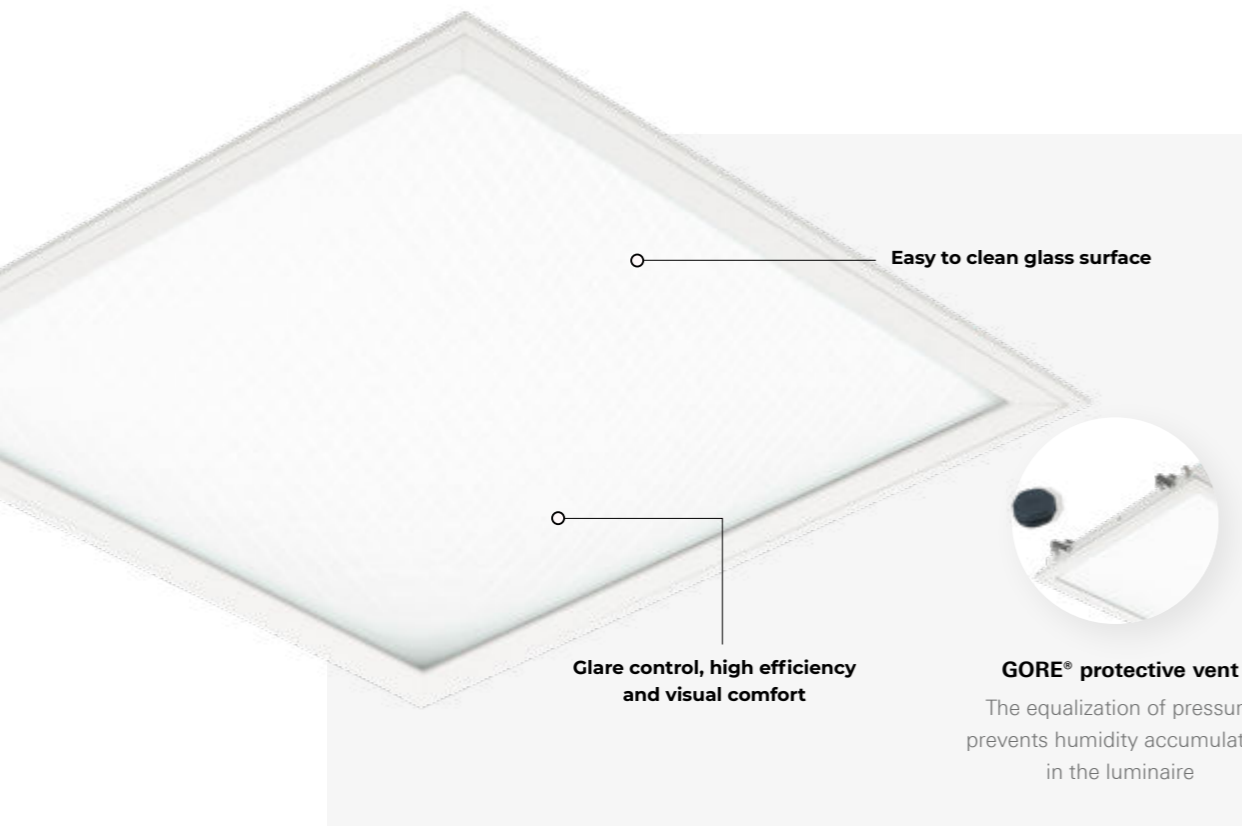

MAIN FEATURES

Excellent light quality

Glare control, maximum efficiency and high uniformity, resulting in outstanding comfort in medical areas. Available in different shapes and sizes.



Suitable for clean rooms

The smooth glass surface with magnet fastening allows easy installation and service, minimizes the accumulation of dirt and it's easy to clean. Appropriate for laboratories, medical and pharmaceutical areas.

Alkon

Technical Overview



UGR <19



	DPR Soft-light prismatic optics	PR Microprismatic optics	HMP Satin silver coated aluminium louvre
Luminaire luminous flux			
300 R	3300 - 5400 lm	3600 - 5800 lm	3500 - 5600 lm
600	3400 - 5400 lm	3800 - 5900 lm	3500 - 5600 lm
LED colour	830, 840, 930, 940	830, 840, 930, 940	830, 840, 930, 940
Driver	Casambi, DALI, FO	Casambi, DALI, FO	Casambi, DALI, FO
Emergency kit	EM 1h, EM 3h	EM 1h, EM 3h	EM 1h, EM 3h
IP protection	IP65	IP65	IP65

Dimensions

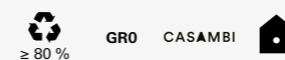
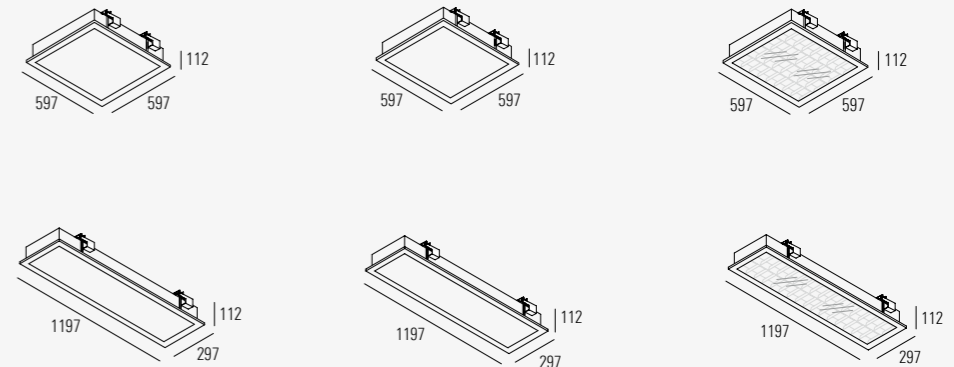

Light source: High-flux PCB LED modules, mid-power SMD LED, CRI>80/90, MacAdam≤2, 50.000h L90 B10 at 35°C. **Optic:** Double parabolic silver-coated satin aluminium louvre with transparent tempered glass protection (HMP), Soft-light prismatic tempered glass diffuser (DPR), Prismatic tempered glass (PR). **Body:** Steel-sheet, powder coated. **Control gear:** Integrated highly-efficient driver with fixed output (FO) or dimmable (DALI-TD, Casambi). **Emergency:** Emergency kit version with autonomy 1h or 3h. **Power supply:** 230V 50Hz.

Svetlobni vir: PCB LED moduli visoke svetilnosti, z SMD LED, CRI>80/90, barvno odstopanje MacAdam≤2, 50.000 h L90 B10 na 35 °C. **Optika:** Parabolna optika iz visoko odsevnega satiniranega aluminija zaščitena s transparentnim kaljenim steklom (HMP), Prizmatično kaljeno steklo z notranjim opalnim difuzorjem (DPR), Prizmatično kaljeno steklo (PR). **Ohišje:** Pločevina, prašno barvana. **Napajalnik:** Integriran visoko učinkoviti LED konverter s konstantnim tokom (FO) ali regulacijskim izhodom (DALI-TD, Casambi). **Varnostni modul:** Varnostni modul z 1 ali 3 urami avtonomije. **Napajanje:** 230 V 50 Hz.

Izvor svetla: PCB LED moduli velikog svetlosnog toka, SMD LED srednje snage, CRI>80/90, MacAdam≤2, 50.000 h L90 B10 na 35 °C. **Optika:** Dvostruko parabolni raster od aluminija parenog srebrom sa zaštitnim kaljenim staklom (HMP), Mikroprizmatična difuzna optika od kaljenog stakla (DPR), Prizmatično kaljeno staklo (PR). **Kućište:** Dekapirani čelik, elektrostatski plastificiran. **Predspojne naprave:** Integrirana visoko efikasna predspojna naprava konstantnog izlaza (FO) ili dimabilna (DALI-TD, Casambi). **Režim nužne rasvjete:** Modul nužne rasvjete autonomije 1 ili 3h. **Napajanje:** 230 V 50 Hz.

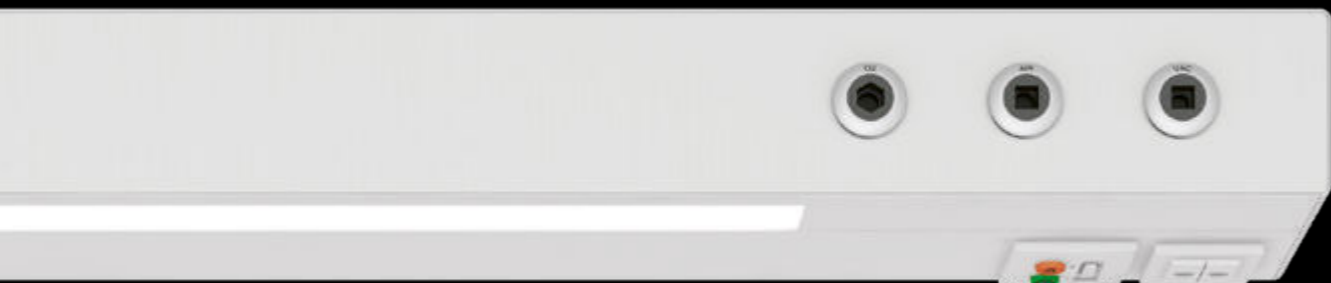

Medis

Care 24 / 7

Comfortable illumination for a faster recovery

Medis can adapt easily to a multitude of needs, considering what the patients, nursing staff and visitors need. This flexible illumination enhances the well-being while providing for a better living comfort in an unfamiliar environment.

Different lighting settings are possible: for examination rounds, visiting times, reading, night or daytime illumination. Besides optimal illumination, Medis offers an integration system with power inlets, communication outlets and medical gases.

Udobna osvetlitev za hitrejše okrevanje

Medis se zlahka prilagodi raznolikim potrebam bolnikov, zdravstvenega osebja in obiskovalcev. Ta fleksibilnost osvetlitve nudi večje bivalno udobje v sicer nedomačnem okolju in tako prispeva k dobremu počutju.

Na voljo so različne svetlobne nastavitve: za zdravniške vizite, čas obiskov, branje, nočna ali dnevna osvetlitev. Poleg optimalne osvetlitve nudi Medis tudi integriran sistem z vtičnicami, komunikacijskimi izhodi in medicinskimi plini.

Komforna rasvjeta za brži oporak

Medis se tako može prilagoditi raznovrsnim potrebama, imajući u vidu potrebe pacijenata, zdravstvenog osoblja i posjetitelja. Ova fleksibilna rasvjeta poboljšava dobrobit pružajući bolji životni komfor u nepogodnom okružju.

Moguće su različite postavke rasvjete: za ispitne vizite, vrijeme posjeta, čitanje, noćne ili dnevne rasvjete. Pored optimalne rasvjete, Medis nudi integracijski sustav s naponskim priključcima, komunikacijskim izlazima i medicinskim plinovima.



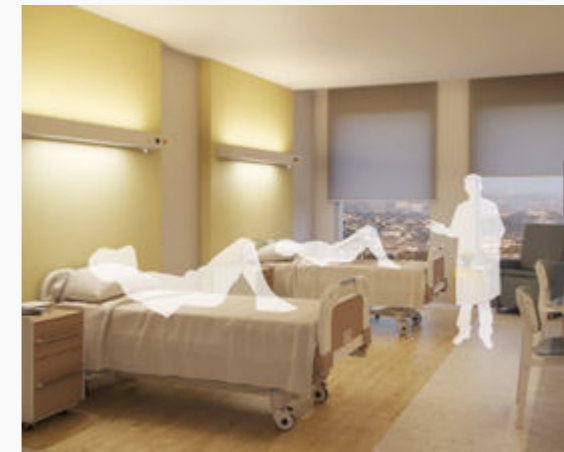

When the doctor visits

Medis provides a uniform, glare-free lighting environment that is required for nursing tasks and simple examinations. It offers maximum luminance of 1,000 lux in the examination mode.

Afternoon activities

Soft, pleasant and glare-free light, that could be customized. Patients should also be given a flexible light with a dimmable controller. Medis is hygienic as it is made from materials that reduce dust exposure and are easy to clean.

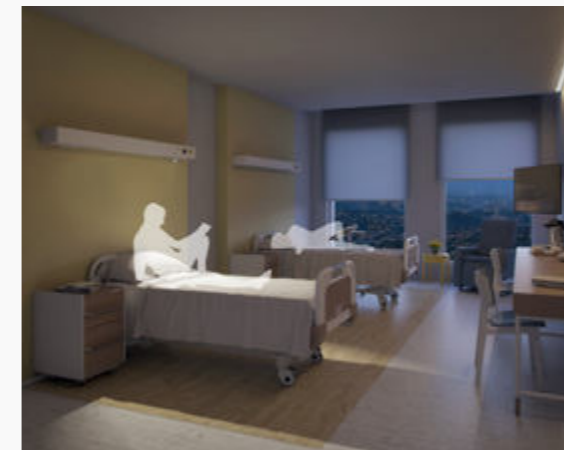

Individual activities

And even when the night kicks in, patients could still do their own thing without disturbing others. One could read, second one sleep, the third one browses on the phone ... A discrete light that gives your patients a freedom of setting their own routine.

It's night time

The best light at night is no light. But in hospitals you need light for orientation. This is light that you see only when you need it.

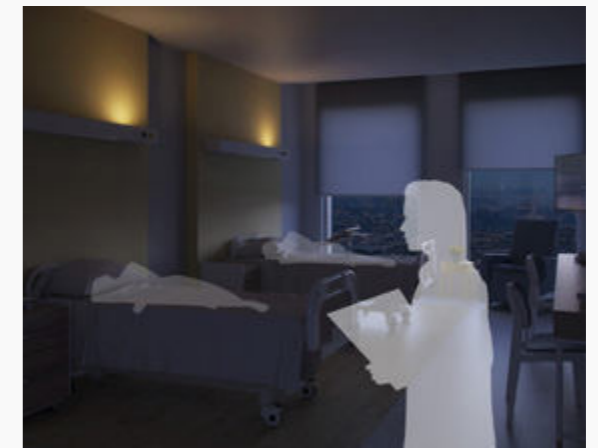

Medis

Technical Overview

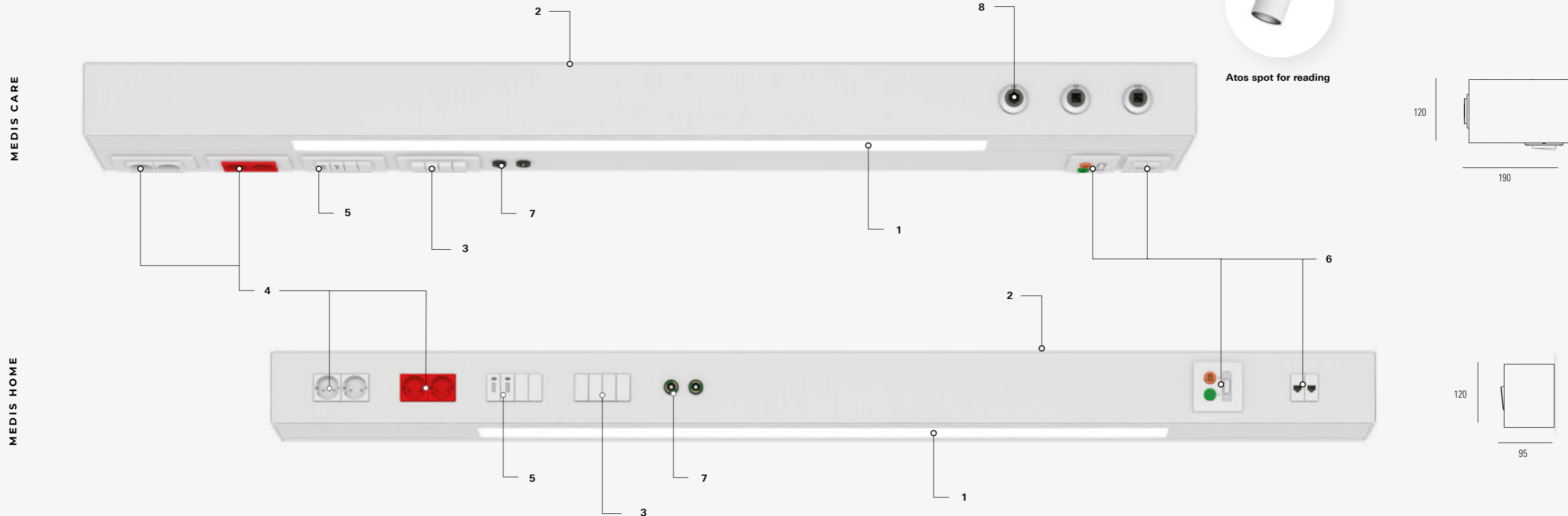

1 Direct linear module

LED colour: 830, 840, 930, 940, Tunable white (2700K - 6500K).
Light line lengths: 560 - 1120 mm.
Luminous flux: 1550 - 3900 lm.

2 Uplight linear module

LED colour: 830, 840, 930, 940, Tunable white (2700K - 6500K).
Light line lengths: 840-1400 mm.
Luminous flux: 2350 - 4900 lm.

3 Light control

Required flexible illumination scenarios can be prepared for different tasks and activities during day and night time (examination, visit, reading). They can be controlled by switches, push buttons, or in connection with a nurse call remote handset.

4 Power supply

Medical unit can be equipped with up to 6 power supply sockets. They may be used individually or for life-dependent equipment connected to an uninterrupted power supply (UPS).

5 USB charger

Single or double 230V USB charger socket can be integrated for convenient charging of electronic devices.

6 Communication / network

Integrated communication panels offer individual usage of a data network via requested UTP sockets, as well as a connection to medical devices and instruments. Furthermore, requested emergency call panel with additional handset can be integrated for nurse call and light control.

7 Equipotential bonding bolts

In accordance with standards, equipotential earth bonding bolts can be installed to ensure required protection for equipment and personal.

8 Medical gases

Each medical bed head unit can be equipped with up to three medical gas sockets. According to request, bed head unit can be customized for different medical gas socket types and supplied with or without the sockets (medical gas ready).



Light source: High-flux PCB LED modules, mid-power SMD LED, CRI>80/90, MacAdam≤2, 50.000h L90 B10 at 35°C. **Optic:** Satin opal polycarbonate diffuser (SOP), Soft-light prismatic PMMA diffuser (DPR). **Body:** Extruded aluminium profile, powder coated. **Control gear:** Integrated highly-efficient driver with fixed output (FO) or dimmable (DALI-TD). **Power supply:** 230V 50Hz.

Svetlobni vir: PCB LED moduli visoke svetilnosti, z SMD LED, CRI>80/90, barvno odstopanje MacAdam≤2, 50.000 h L90 B10 na 35 °C. **Optika:** Satinirani opalni polikarbonatni difuzor (SOP), Mikro-prizmatična difuzna PMMA optika (DPR). **Ohišje:** Ekstrudiran profil iz aluminija, prašno barvan. **Napajalnik:** Integriran visoko učinkoviti LED konverter s konstantnim tokom (FO) ali regulacijskim izhodom (DALI-TD). **Napajanje:** 230 V 50 Hz.

Izvor svetla: PCB LED moduli velikog svjetlosnog toka, SMD LED srednje snage, CRI>80/90, MacAdam≤2, 50.000 h L90 B10 na 35 °C. **Optika:** Satinirani opalni polikarbonatni difuzor (SOP), Mikroprizmatična difuzna PMMA optika (DPR). **Kućište:** Ekstrudirani aluminijski profil, elektrostatski plastificiran. **Predspojne naprave:** Integrirana visoko efikasna predspojna naprava konstantnog izlaza (FO) ili dimabilna (DALI-TD). **Napajanje:** 230 V 50 Hz.



Sequal

Specialised in optics

Efficiency and quality can go a long way

Sequal is a true superstar in the field of industrial lighting. It offers uniform professional lighting and is easy to install.

It is powerful enough to be installed on different heights. Unlike other luminaires Sequal is much more efficient in focusing the light, without making compromises with its looks. It's clean, it's minimal, it's super slim.

Z učinkovitostjo in kakovostjo se daleč pride

Sequal je prava zvezda na področju industrijske razsvetljave. Zagotavlja enotno profesionalno osvetlitev in je enostavna za namestitev.

Svetilka je dovolj močna, da jo lahko namestite na različne višine. Za razliko od drugih svetilk je Sequal veliko bolj učinkovita pri usmerjanju svetlobe, pri tem pa ji ni treba sklepati kompromisov glede videza. Svetilka je čista, minimalistična in izjemno tanka.

Učinkovitost i kvaliteta na duge staze

Sequal je istinska superzvezda u području industrijske rasvjete. Nudi ujednačeno profesionalno osvjetljenje i jednostavan je za ugradnju.

Dovoljno je snažan za ugradnju na različite visine. Za razliku od ostalih svjetiljki, Sequal je mnogo učinkovitiji u fokusiranju svjetla, bez kompromisa u izgledu. Čist je, minimalističan i super tanak.





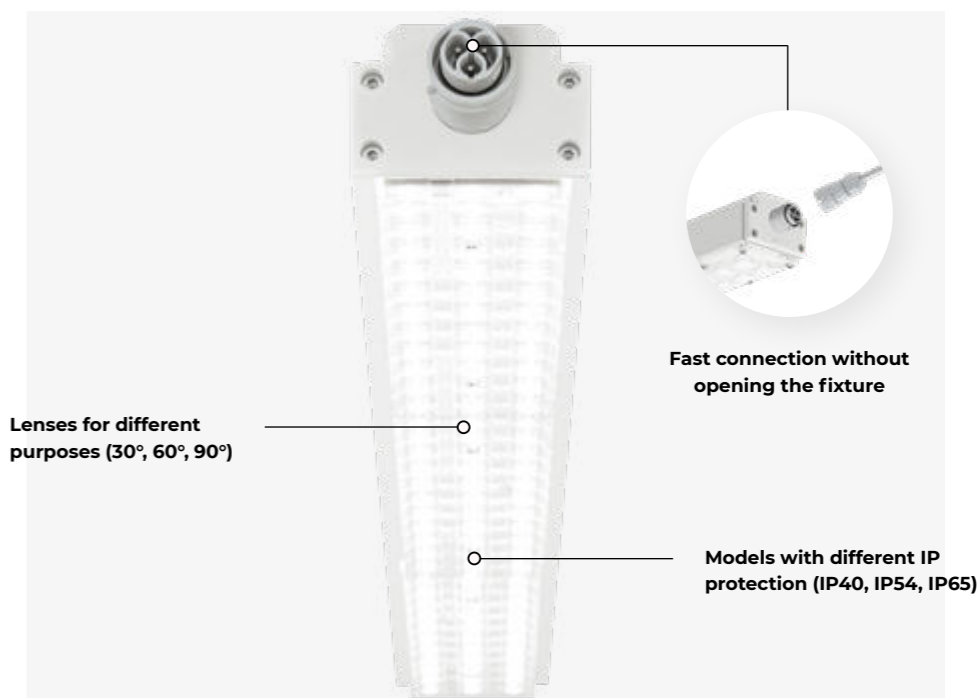

MAIN FEATURES



Choose your optimal line configuration

With different combination of blind and luminous modules you can select optimal configuration for project needs. Single system connection and plug-in connectors between various line modules ensure fast and cost-effective installation.

IP protection for different needs

Choose among IP40, IP54 or IP65 to match your ambiance needs, from clean warehouses to hars production plants, where dust protection fixtures are required.

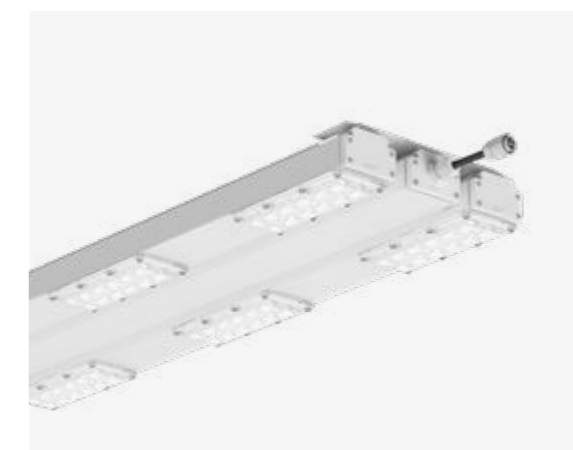

Sequal

Technical Overview



	IP40 LL*	IP54	IP65 2 modules	IP65 4 modules	IP65 2+2 modules	IP65 3+3 modules
Installation	Suspended	Ceiling / Suspended	Ceiling / Suspended	Ceiling / Suspended	Ceiling / Suspended	Ceiling / Suspended
Luminaire luminous flux	1700 - 4800 lm/m	6500 - 8900 lm/m	7800 - 8300 lm	15000 - 15800 lm	15700 - 16600 lm	23500 - 24800 lm
Optics	30°, 60°, 90°	30°, 60°, 90°	30°, 60°, 90°	30°, 60°, 90°	30°, 60°, 90°	30°, 60°, 90°
LED colour	830, 840	830, 840	830, 840	830, 840	830, 840	830, 840
Driver	DALI, FO	DALI, FO	DALI, FO	DALI, FO	DALI, FO	DALI, FO
Emergency kit	EM spot 1h/3h with corridor/ symmetric optic	-	-	-	-	-
IP protection	IP40	IP54	IP65	IP65	IP65	IP65
IK protection	IK 05	IK 05	IK 07, Ballproof	IK 07, Ballproof	IK 07, Ballproof	IK 07, Ballproof
Ambient temperature	from -25° to +45°	from -25° to +45°	from -25° to +45°	from -25° to +45°	from -25° to +45°	from -25° to +45°
Colour	1 2	1 2	1 2	1 2	1 2	1 2

Dimensions	L (mm): 2000, 3000	L (mm): 1215 - 3009				
	LL 2 LL 3 LL 4 LL 5*					
	*available only for 3000 mm					

* Use Intra Constructor PRO to design Sequal IP40 LL / Available also as a ball-proof version in accordance with DIN 18032-3 and DIN EN 13964



Light source: High-flux PCB LED modules, mid-power SMD LED, CRI>80, MacAdam≤2, 50.000h L80 B10 at 35°C. / High-power LED, CRI>80, MacAdam≤2, 50.000h L80 B10 at 35°C. **Optic:** Highly efficient acrylic optical lenses. **Body:** Extruded aluminium profile, powder coated. **Ceiling cup:** For suspended versions, the ceiling cup and suspension set must be ordered separately. Find out more on the technical pages or online product configurator. **Control gear:** Integrated highly-efficient driver with fixed output (FO) or dimmable (DALI). **Emergency:** Emergency kit version with autonomy 1h or 3h. **Power supply:** 230V 50Hz.

Svetlobni vir: PCB LED moduli visoke svetilnosti, z SMD LED, CRI>80, barvno odstopanje MacAdam≤2, 50.000 h L80 B10 na 35 °C. / Visoko učinkovit LED modul, CRI>80, barvno odstopanje MacAdam≤2, 50.000h L80 B10 na 35°C. **Optika:** Visoko učinkovite optične leče iz akrila. **Ohišje:** Ekstrudiran profil iz aluminija, prašno barvan. **Stropna rozeta:** Za viseče verzije se rozete in vešala naročajo posebej. Več na straneh s tehnično vsebino ali v spletnem konfiguratorju. **Napajalnik:** Integriran visoko učinkoviti LED konverter s konstantnim tokom (FO) ali regulacijskim izhodom (DALI). **Varnostni modul:** Varnostni modul z 1 ali 3 urami avtonomije. **Napajanje:** 230 V 50 Hz.

Izvor svetla: PCB LED moduli velikog svetlosnog toka, SMD LED srednje snage, CRI>80, MacAdam≤2, 50.000 h L80 B10 na 35 °C. / LED velike snage, CRI>80, MacAdam≤2, 50.000 h L80 B10 na 35 °C. **Optika:** Visokoeffikasne akrilne leče. **Kućište:** Ekstrudirani aluminijski profil, elektrostatski plastificiran. **Stropna rozeta:** Za ovesne inačice, stropna rozeta i ovesni pribor moraju biti naručeni zasebno. Otkrij više na tehničkim stranicama ili online konfiguratoru proizvoda. **Predspojne naprave:** Integrirana visoko efikasna predspojna naprava konstantnog izlaza (FO) ili dimabilna (DALI). **Režim nužne rasvjete:** Modul nužne rasvjete autonomije 1 ili 3h. **Napajanje:** 230 V 50 Hz.



Arago

Born to be efficient

The star of »before and after« stories, unbeatable in bringing energy consumption down

Industrial illumination used to be a big consumer of energy. Arago not only overcame this problem, it was designed to reach higher industry demands; long-term quality, resistant to high ambient temperatures, improved performance for better visual comfort and faster installation.

With the lighting fixture refurbishment, you will be able to save on energy and achieve a faster payback time. From that point on, the new lighting will generate a profit.

Zvezda »prej in potem« zgodb, nepremagljiv v zniževanju porabe energije

Industrijska razsvetljava je bila od nekdaj velik porabnik energije. Arago ni le odpravil tega problema, ustvarjen je bil, da bi zadostil višjim potrebam v industriji, kot so dolgoročna kakovost, odpornost na visoke temperature, vizualno udobje in hitra montaža.

Prenova razsvetljave omogoča prihranke pri energiji in skrajšuje čas povrnitve investicije. Od tu dalje pa nova razsvetljava ustvarja profit.

Zvijezda priča o »prije i poslije«, nepobjediv u smanjenju potrošnje energije

Industrijska rasvjeta je nekada bila veliki potrošač energije. Arago ne samo da je riješio ovaj problem, već je osmišljen kako bi zadovoljio veće zahtjeve industrije; dugotrajna kvaliteta, otpornost na visoke temperature, bolji vizualni komfor i brža ugradnja.

Obnovom rasvjetnog tijela moći ćete uštedjeti na energiji i postići brže vrijeme povrata. Od tog trenutka nova će rasvjeta donositi profit.



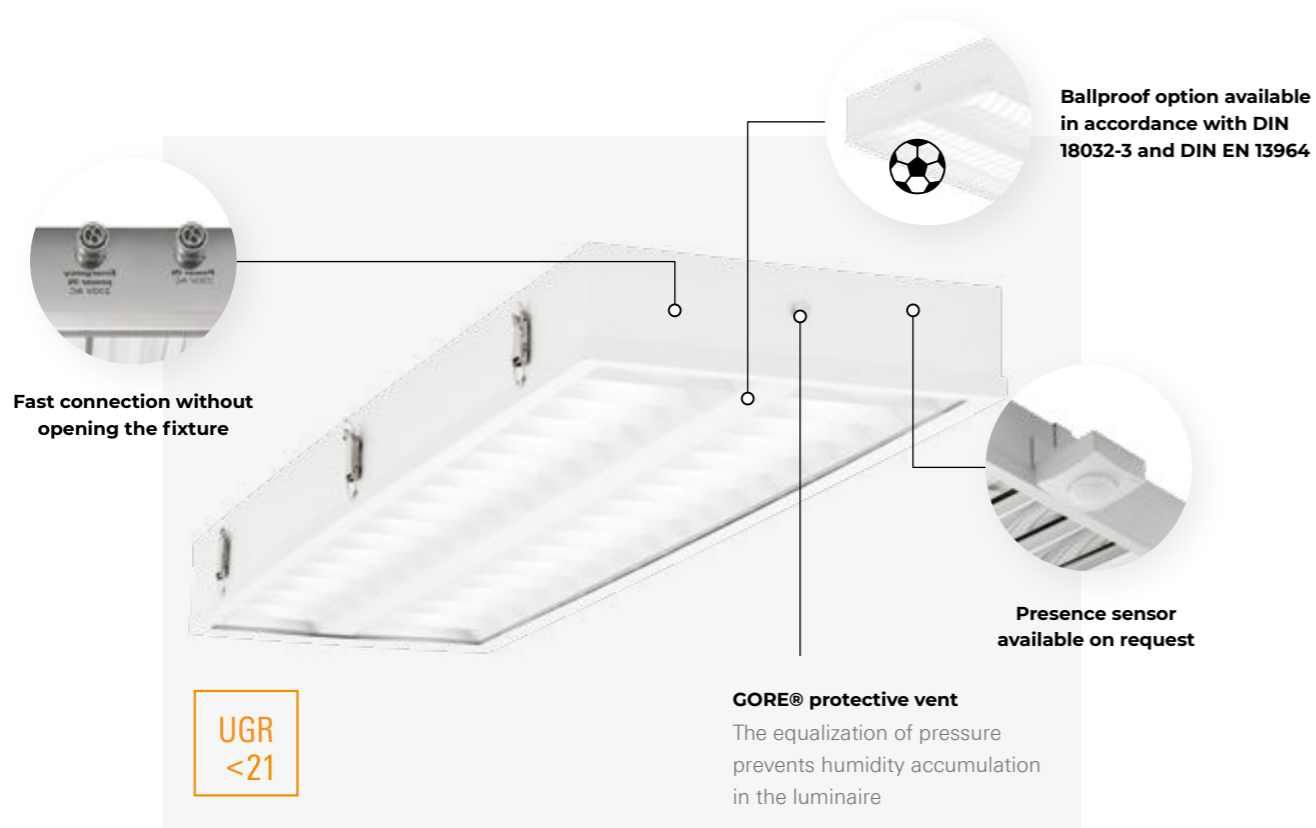

* UGR <21 optic is not available for Steel sheet IP65 with grid version

MAIN FEATURES



Easy installation

Slide-in installation of the luminaire in one click. With pre-installation of the ceiling mounting plate the luminaire can be installed within minutes. For suspended installation a suspension chain (4 m) is available.

Ultra-resistant stainless steel AISI 316 L

Arago is made for harsh conditions. Its housing from stainless steel makes it ultra-resistant to moisture and dust. The light sources are covered with transparent glass or PMMA screen, making it suitable for use in the food industry as well.



Arago

Technical Overview



	IP65 Protection and efficiency	IP65 GRID High impact protection IK10	IP65 STAINLESS STEEL For harsh environments
Luminaire luminous flux	7500 - 27500 lm	7400 - 23600 lm	7500 - 27500 lm
Optic type	Transparent glass / PMMA screen	Satin PMMA diffuser	Transparent glass / PMMA screen
Optic	Narrow, Wide, Wide UGR < 21	Wide	Narrow, Wide, Wide UGR < 21
LED colour	830, 840	830, 840	830, 840
Driver	FO, DALI	FO, DALI	FO, DALI
Emergency kit	EM 1h, EM 3h	EM 1h, EM 3h	EM 1h, EM 3h
Material	Steel-sheet, powder coated	Steel-sheet, powder coated	Stainless steel AISI 316L
IP protection	IP65	IP65	IP65
IK protection	IK 08 (glass) / IK 07 (PMMA)	IK 10*	IK 08 (glass) / IK 07 (PMMA)
Ambient temperature	-20°C - + 45°C	-20°C - + 45°C	-20°C - + 45°C
Colour	1	1	Stainless steel
Dimensions	W (mm): 240, 435	W (mm): 240, 435	W (mm): 240, 435

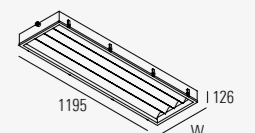
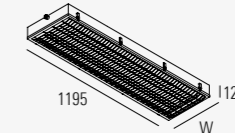
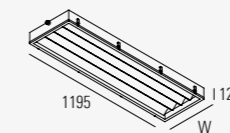

* Available also as a ball-proof version in accordance with DIN 18032-3 and DIN EN 13964

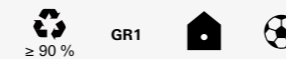

Light source: High-flux PCB LED modules, mid-power SMD LED, CRI>80, MacAdam≤2, 50.000h L80 B10 at 35°C. **Optic:** Satin silver coated aluminium high efficiency optic; narrow or wide light distribution. Transparent tempered glass or transparent PMMA diffuser for IP65 protection. **Body:** Steel-sheet, powder coated; stainless steel AISI 316L (inox version). **Ceiling cup:** For suspended versions, the ceiling cup and suspension set must be ordered separately. Find out more on the technical pages or online product configurator. **Control gear:** Integrated highly-efficient driver with fixed output (FO) or dimmable (DALI-TD). **Emergency:** Emergency kit version with autonomy 1h or 3h. **Power supply:** 230V 50Hz.

Svetlobni vir: PCB LED moduli visoke svetilnosti, z SMD LED, CRI>80, barvno odstopanje MacAdam≤2, 50.000 h L80 B10 na 35 °C. **Optika:** Satinirana optika s posrebrenim aluminijem; ozek ali širok svetlobni snop. Prozorno kaljeno steklo ali prozoren PMMA difuzor za IP65 zaščito. **Ohišje:** Pločevina, prašno barvana; nerjaveče jeklo (AISI 316L) za INOX verzijo. **Stropna rozeta:** Za viseče verzije se rozete in vešala naročajo posebej. Več na straneh s tehnično vsebino ali v spletnem konfiguratorju. **Napajalnik:** Integriran visoko učinkoviti LED konverter s konstantnim tokom (FO) ali regulacijskim izhodom (DALI-TD). **Varnostni modul:** Varnostni modul z 1 ali 3 urami avtonomije. **Napajanje:** 230 V 50 Hz.

Izvor svetla: PCB LED moduli velikog svetlosnog toka, SMD LED srednje snage, CRI>80, MacAdam≤2, 50.000 h L80 B10 na 35 °C. **Optika:** Visoko učinkovita optika od satiniranog aluminija parenog srebrom; uski ili široki snop distribucije svetla. Prozirno kaljeno staklo ili prozirni PMMA difuzor za IP65 stupanj zaštite. **Kučičšte:** Dekapirani čelik, elektrostatski plastificiran; nehrđajući čelik (AISI 316L). **Stropna rozeta:** Za ovesjne inačice, stropna rozeta i ovesjni pribor moraju biti naručeni zasebno. Otkrij više na tehničkim stranicama ili online konfiguratoru proizvođača. **Predspojne naprave:** Integrirana visoko efikasna predspojna naprava konstantnog izlaza (FO) ili dimabilna (DALI-TD). **Režim nužne rasvjete:** Modul nužne rasvjete autonomije 1 ili 3 h. **Napajanje:** 230 V 50 Hz.



5700

The old-school solution

A traditional parking garage resident

It's popular for the mix of functions, fast installation and affordability. With the presence sensors, it has the potential to decrease energy costs, making it appropriate for parking spaces, lit only if someone is present.

With quick connectors and click and lock system, the luminaire can be installed within minutes.

Tradicionalni prebivalec parkirnih hiš

To svetilo je priljubljeno zaradi številnih funkcij, hitre montaže in dostopnosti. Z integriranim senzorjem prisotnosti lahko zmanjša porabo in stroške energije. Osvetlitev samo v času, ko je nekdo prisoten, je za parkirne hiše nadvse prikladna.

S pomočjo sponk za hitri električni priklop napajanja in t. i. click-lock sistema ga lahko namestimo v nekaj minutah.

Stanar tradicionalne parkirne garaže

Prikladan za različite funkcije, brzo ugradnjo i pristupačan. Sa senzorima prisutnosti, ima potencijal smanjenja troškova energije, čineći ga prikladnim za parkirna mjesta, osvijetljena samo u nečijoj prisutnosti.

S brzim spojnicama i »click-lock« sustavom, rasvjetno tijelo može biti ugrađeno unutar nekoliko minuta.



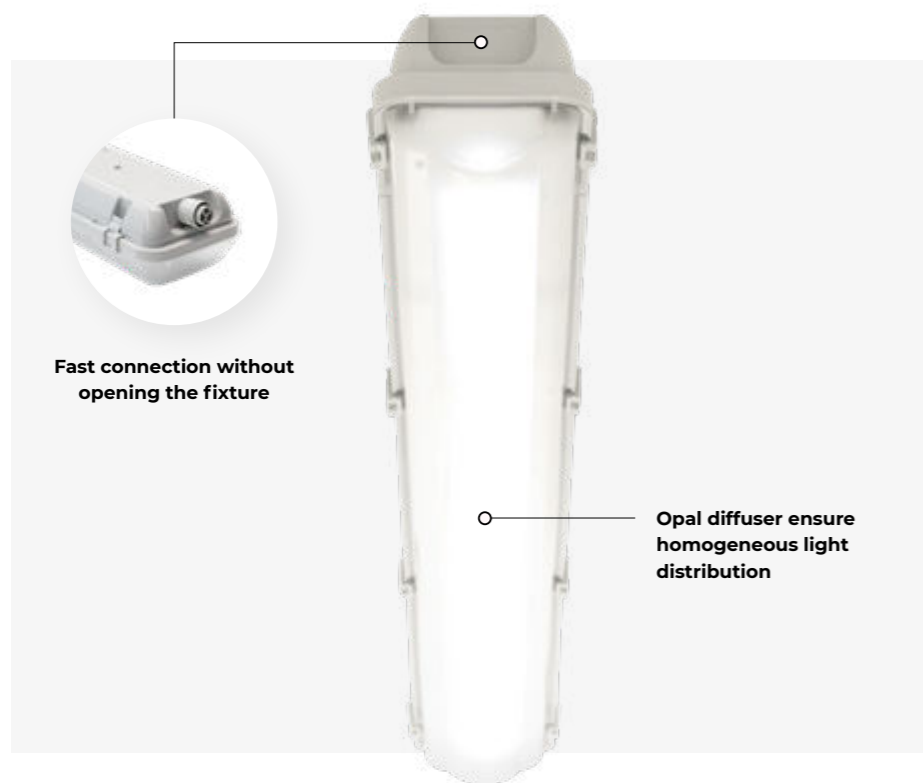

MAIN FEATURES

Two sizes, many power options

Chose the right option depending on your needs or space heights.



It feels at home in refrigerators and freezers

5700 is resistant to extremely low temperatures, down to - 40°C.

5700

Technical Overview



	LED	LED POLAR
Luminaire luminous flux		
W100	3800 - 7000 lm	-
W150	6600 - 8300 lm	4800 - 6600
LED colour	830, 840, 930, 940	830, 840, 930, 940
Driver	FO, DALI	FO, DALI
Emergency kit	EM 1h, EM 3h	/
IP protection	IP66	IP66
IK protection	IK07	IK07
Ambient temperature	-20°C - + 45°C	-20°C / -40°C
Dimensions	L (mm): 1277, 1573	L (mm): 1277

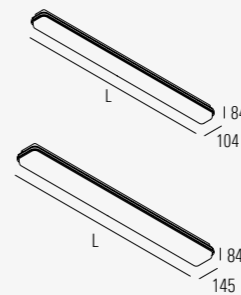

*EM module max ambient temperature is 35°C.



GRO



Light source: High-flux PCB LED modules, mid-power SMD LED, CRI>80/90, MacAdam≤2, 50.000h L90 B10 at 35°C. **Optic:** Satin opal polycarbonate diffuser (SOP) **Body:** Polycarbonate. **Control gear:** Integrated highly-efficient driver with fixed output (FO) or dimmable (DALI-TD). **Emergency:** Emergency kit version with autonomy 1h or 3h. **Power supply:** 230V 50Hz.

Svetlobni vir: PCB LED moduli visoke svetilnosti, z SMD LED, CRI>80/90, barvno odstopanje MacAdam≤2, 50.000 h L90 B10 na 35 °C. **Optika:** Satiniran opalni polikarbonatni difuzor (SOP) **Ohišje:** Polikarbonat. **Napajalnik:** Integriran visoko učinkoviti LED konverter s konstantnim tokom (FO) ali regulacijskim izhodom (DALI-TD). **Varnostni modul:** Varnostni modul z 1 ali 3 urami avtonomije. **Napajanje:** 230 V 50 Hz.

Izvor svetla: PCB LED moduli velikog svetlosnog toka, SMD LED srednje snage, CRI>80/90, MacAdam≤2, 50.000 h L90 B10 na 35 °C. **Optika:** Satinirani opalni polikarbonatni difuzor (SOP) **Kućište:** Polikarbonatno. **Predspojne naprave:** Integrirana visoko efikasna predspojna naprava konstantnog izlaza (FO) ili dimabilna (DALI-TD). **Režim nužne rasvjete:** Modul nužne rasvjete autonomije 1 ili 3h. **Napajanje:** 230 V 50 Hz.



Haron

Imagine. Create. Repeat.

The best angle is tri-angle

Haron can be sophisticated or eclectic, crazily colourful or monotone and classy. It can be your secondary ceiling in a hallway or a building facade. And it's not only about the razzLEDazzle, it can also be assembled as a classical rectangle to use on railway, bus or petrol stations...

Haron is a luminaire that makes the world a brighter place as it enables special effects created with light drawing, making this product so great you simply cannot ignore it.

Najboljši kotnik je trikotnik

Haron je lahko prefinjen in modernističen obenem. Lahko je noro barvit ali umirjeno eleganten. Lahko je vaš nadomestni strop v hodniku ali pa fasada stavbe. Kljub temu da je njegov glavni adut prav raznolikost videza, ga v sestavljeni obliki pravokotnika z lahkoto umestite tudi v nekoliko bolj umirjenih okoljih, kot so železniške ali avtobusne postaje in tudi bencinske črpalke.

Haron torej ne nudi le kakovostne osvetlitve, pač pa tudi možnost, da z njim ustvarjate posebne učinke, zaradi katerih ne more ostati neopažen.

Najbolji kut je trokut

Haron može biti profinjen ili nesustavan, ludo šaren ili monoton i elegantan, može biti vaš sekundarni strop u hodniku ili fasada zgrade. Ne radi se samo o privlačenju pažnje, već se može sastaviti i kao klasični pravokutnik koji se koristi na željezničkim, autobusnim ili benzinskim postajama...

Haron je rasvjetno tijelo koje svijet čini svjetlijim mjestom, omogućujući specijalne efekte stvorene svjetlosnim crtežom, čineći ovaj proizvod tako dobrim da ga jednostavno ne možete zanemariti.



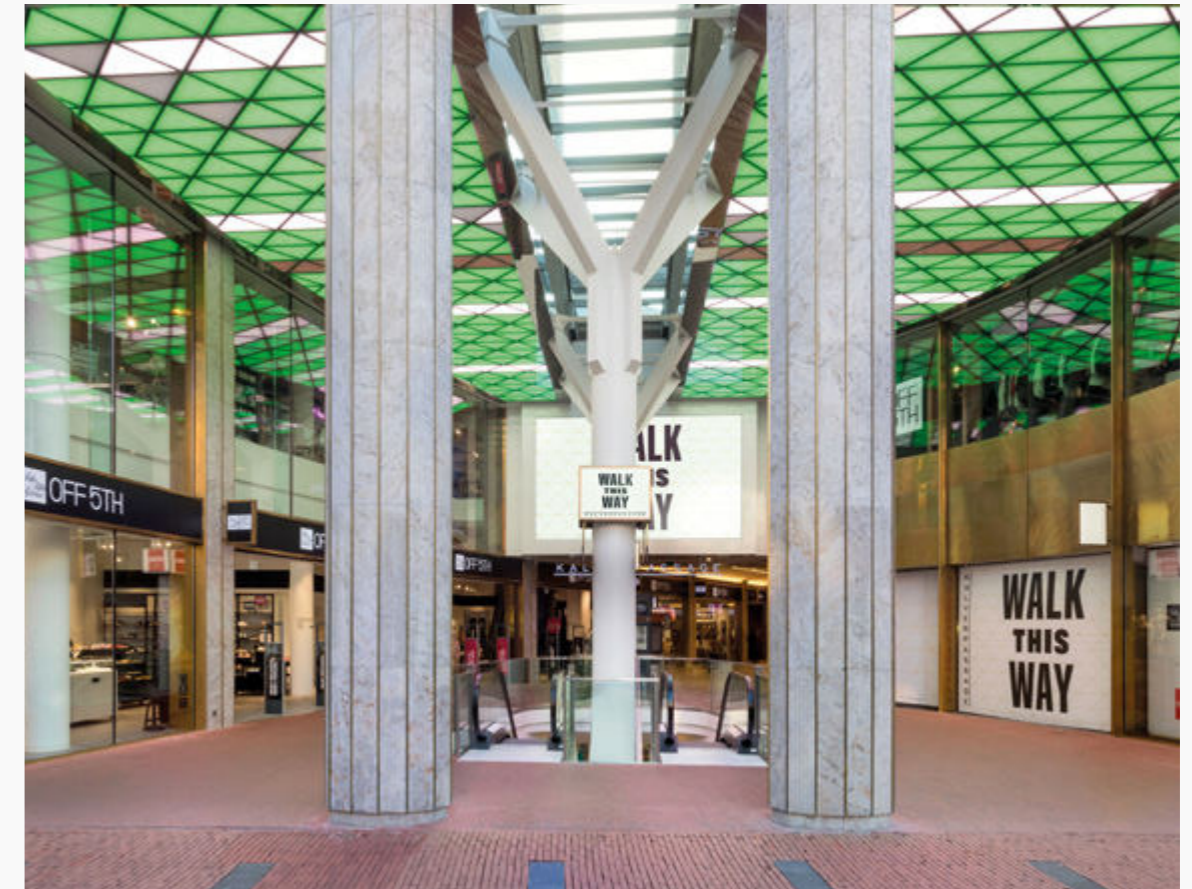

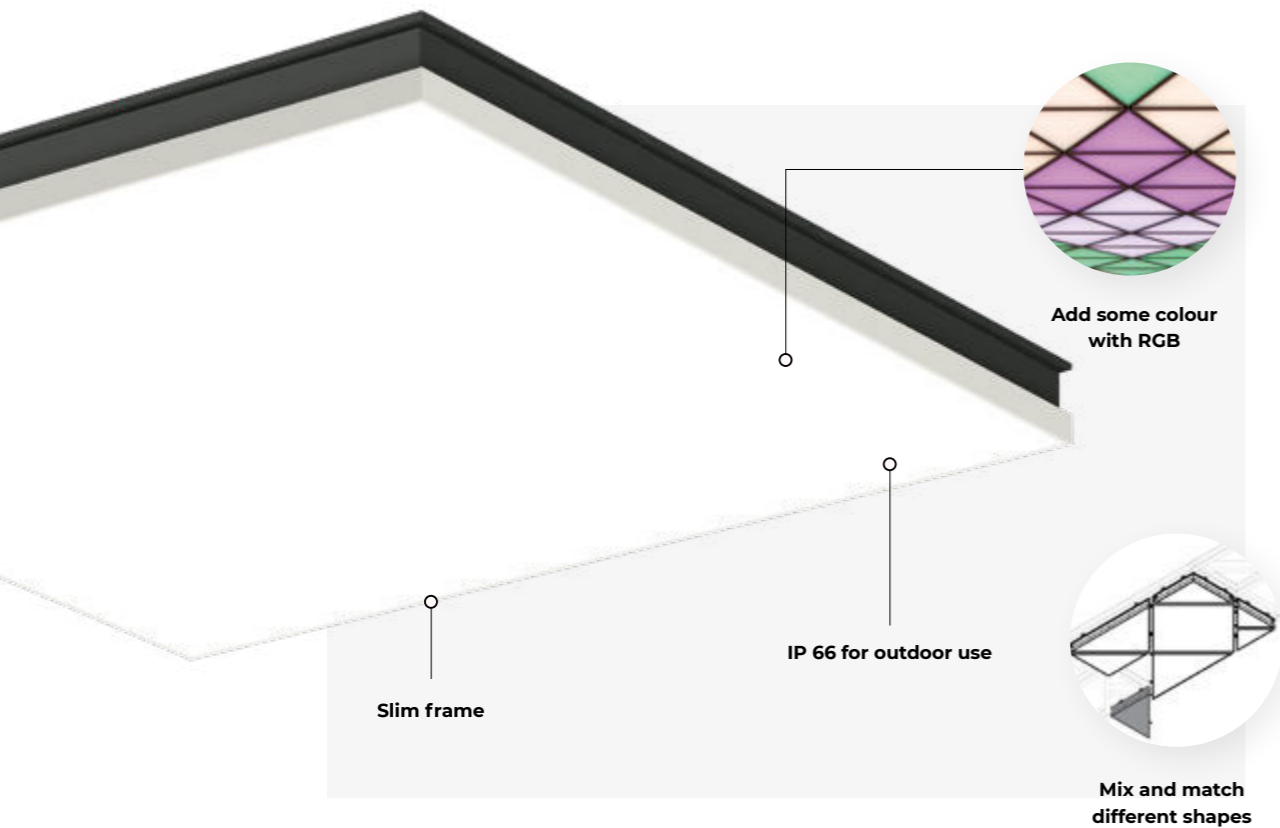

MAIN FEATURES



Outdoor use

IP66 protection makes this luminaire suitable for outdoor applications where light is exposed to rain, dust and high temperatures.

Combine different shapes, sizes and colours

There are many application possibilities. You can mount it on different inclinations, create a pattern or choose an RGB option to create a colourful image. The frame is slim, so the space between the products is minimal.



Haron

Technical Overview



	T Triangle	SQ Square	L Linear
Luminaire luminous flux	1150 - 6900 lm	11300- 14200 lm	4800 -9600m
Optics	SOP	SOP	SOP
LED colour	830, 840, 930, 940, RGBW	830, 840, 930, 940, RGBW	830, 840, 930, 940
Driver	DALI	DALI	DALI
Driver position	Integrated, Remote (RGBW)	Integrated, Remote (RGBW)	Integrated, Remote (RGBW)
IP protection	IP66	IP66	IP66
Colour	9	9	9
Dimensions	LxW (mm): 472x334, 695x491, 1002x709		

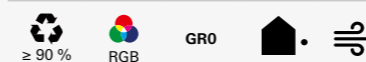
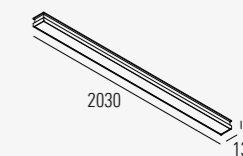
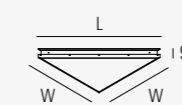

Light source: High-flux PCB LED modules, mid-power SMD LED, CRI>80/90, MacAdam≤2, 50.000h L90 B10 at 35°C. **Optic:** Satin opal glass diffuser (SOP) **Body:** Aluminium frame and steel sheet backplate. **Control gear:** Integrated highly-efficient driver dimmable (DALI). Some versions require externally mounted driver - order separately. **Power supply:** 230V 50Hz / 24V DC / POE ready.

Svetlobni vir: PCB LED moduli visoke svetilnosti, z SMD LED, CRI>80/90, barvno odstopanje MacAdam≤2, 50.000 h L90 B10 na 35 °C. **Optika:** Satinirani opalno steklo (SOP) **Ohišje:** Aluminijast okvir in pločevinasta zadnja plošča. **Napajalnik:** Integriran visoko učinkoviti LED z regulacijskim izhodom (DALI). Nekatere verzije zahtevajo zunanji LED konverter - naročiti ločeno. **Napajanje:** 230 V 50 Hz / 24 V DC / POE ready.

Izvor svetla: PCB LED moduli velikog svetlosnog toka, SMD LED srednje snage, CRI>80/90, MacAdam≤2, 50.000 h L90 B10 na 35 °C. **Optika:** Satinirani opalni stakleni difuzor (SOP) **Kućište:** Aluminijски okvir, stražnja ploča iz dekapiranog čelika. **Predspojne naprave:** Integrirana visoko efikasna dimabilna predspojna naprava (DALI). Neke inačice zahtijevaju izdvojenu predspojnu napravo - naručiti zasebno **Napajanje:** 230 V 50 Hz / 24 V DC / POE ready.

230V 3-phase track

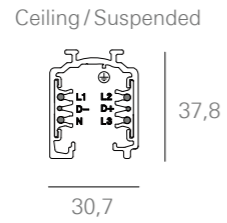
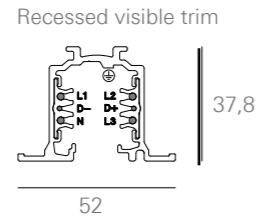

Track RV

3 phase track with control line
Lengths (mm): 1000, 2000, 3000
Colour: Black, white

Track C/S

3 phase track with control line
Lengths (mm): 1000, 2000, 3000
Colour: Black, white

Module types

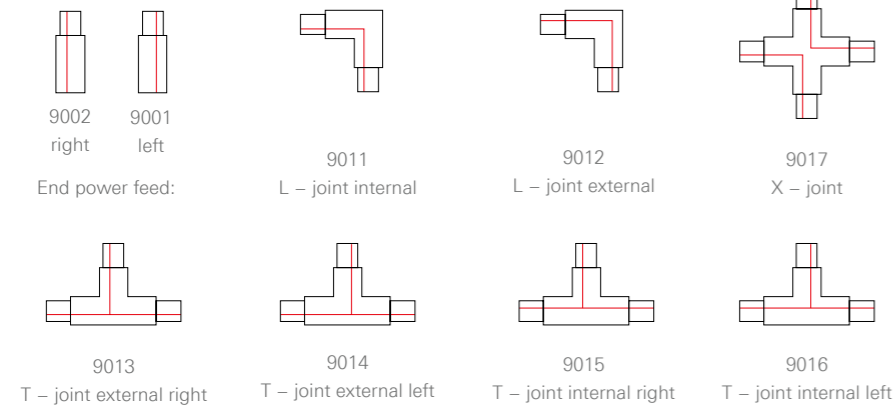

Suspended installation

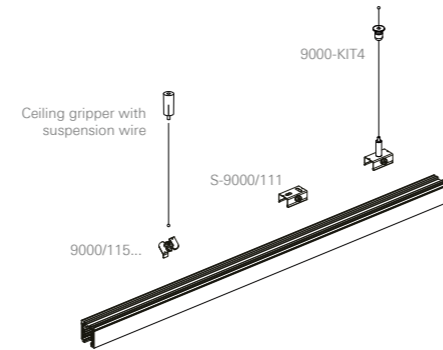

Module configuration

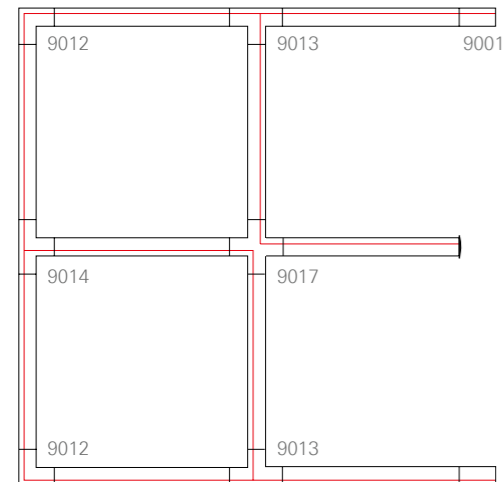

Floor view – red line indicates external ridge of the track

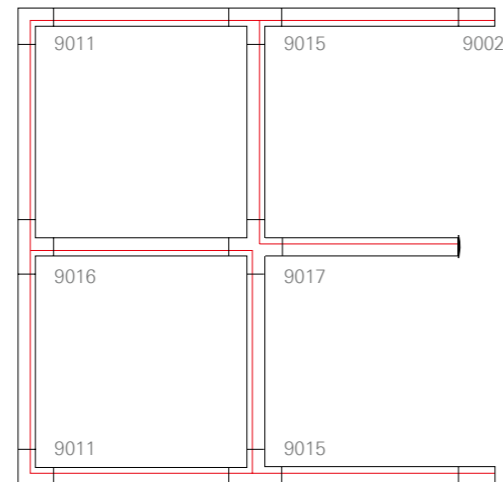

Red line indicates internal ridge of the track

48V track



Recessed visible trim-less

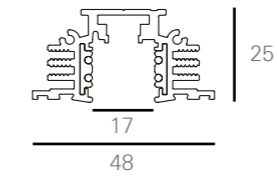

Ceiling / Suspended

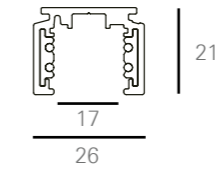

Suspended round

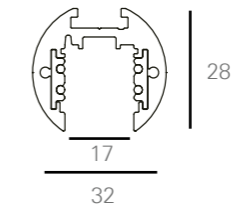

Track RI

48V track with control line
Lengths (mm): 1000, 2000, 3000
Colour: Black

Track C/S

48V track with control line
Lengths (mm): 1000, 2000, 3000
Colour: Black

Track SR

48V track with control line
Lengths (mm): 1000, 2000, 3000
Colour: Black

Compatible with:

Compatible with spots and pendant insets from Lynar (p. 226).



Joints and corners

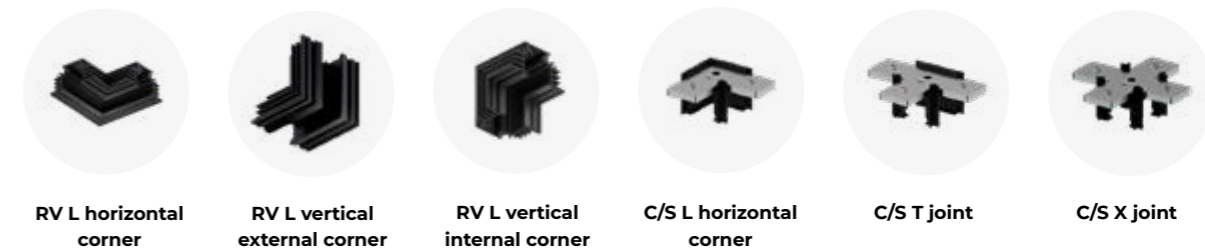

Accessories

End caps



Connections



Suspensions



Ceiling cups

With integrated driver

RD 134



Driver position: Integrated
 Driver: DALI, FO
 Driver type: CC constant current, 24V constant voltage
 Current set: 125-1050 mA (FO) 125-500 mA (DALI)

RD 250



Driver position: Integrated
 Driver: Casambi, DALI, FO
 Driver type: CC constant current, 24V constant voltage
 Current set: 150/250/350 mA
 Cable position: Cluster side / central

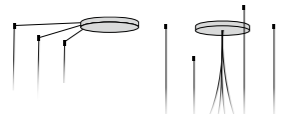

RD 170



Driver position: Integrated
 Driver: DALI, FO
 Driver type: CC constant current
 Current set: 125-1050 mA (FO), 125-500 mA (DALI)

LD 36

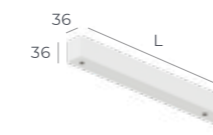

Driver position: Integrated
 Driver: Casambi, DALI, FO
 Driver type: CC constant current, 24V constant voltage
 Current set: 150/250/350 mA
 Dimensions (L): 1200 - 1800 mm / 3x or 5x cable exit

For remote driver position without power cable

RF (Round Flat)* **RH (Round High)*** *Available with 4 mm or 10 mm cable hole



With power cable

RF (Round Flat)

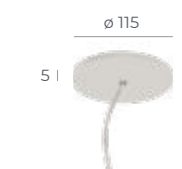

Driver position: In the product
 Power cable suspension height (SH): 1500, 3000, 5000 mm
 Power cable type: 2x0,2 mm²; 7x0,25mm²; 3/5x0,75 mm²; 3/5x1,5 mm²
 Power cable colour: Transparent / Black / White
 Suspension set: Order separately

RH (Round High)



Driver position: In the product
 Power cable suspension height (SH): 1500, 3000, 5000 mm
 Power cable type: 2x0,2 mm²; 7x0,25mm²; 3/5x0,75 mm²; 3/5x1,5 mm²
 Power cable colour: Transparent / Black / White
 Suspension set: Order separately

RH 250 C (Round height)



Driver position: In the product
 Power cable suspension height (SH): 1500, 3000, 5000 mm
 Power cable type: 3/5x0,75 mm²; 3/5x1,5 mm²
 Power cable colour: Transparent
 Suspension set: Included

SH (Square height)



Driver position: In the product
 Power cable suspension height (SH): 1500, 3000, 5000 mm
 Power cable type: 3/5x0,75 mm²; 3/5x1,5 mm²
 Power cable colour: Transparent
 Suspension set: Order separately

LS (Linear square)

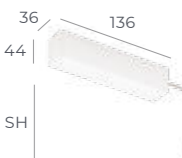

Driver position: In the product
 Power cable suspension height (SH): 1500, 3000, 5000 mm
 Power cable type: 3/5x0,75 mm²; 3/5x1,5 mm²
 Power cable colour: Transparent
 Suspension set: Order separately

Ceiling cups by products

Order the ceiling cup separately

	With integrated driver				With remote driver position		With power cable				
	RD 134	RD 170	RD 250	LD 36	RF	RH	RF	RH	RH 250 C	LS	SH
Biba	*	*	*	*	*	*					
Pixy S	*	*	*		*	*					
Zoe	*	*	*	*	*	*					
Dawn			*		*	*					
Black Hole							*	*	*		
Futon	600 mm		*		*	*					
Lysabel			*		*	*					
Issa			*		*	*					
Gramm			*		*	*					
Glazer										*	
Minus							*			*	
Kalis							*			*	
Random							*			*	
Hexagon							*			*	
Rylo Pro							*			*	
Lynar							*	*		*	
Trix							*			*	
Gyon							*			*	
Wave							*	*			
Wave Round							*	*	up to 1520 mm		
Acousto							*	*			
Sword							*			*	
Rylo C/S											
Pipes S 45	*	*	*		*	*					
Hunter S	*	*	*		*	*					
Nola S	*	*	*		*	*					
Lona							*	*	600/900		
Canvas C/S							*			*	
Demi SDI							*				*
Sequal											*

Ceiling cup / Track adapter included

	With integrated driver			With power cable				Track adapter
	RD 134	RD 170	LD	RF	RH	RH 250	LS	TR
Pipes Tube S					*			
Pipes Tube S Cluster						*		
Vitka S			*					
Skyler			*	*				
Night&Day							*	
Mocca							*	
Camay							*	
Minus S Square							*	
Pipes S 100/133					*			*
Hunter S								*
Karo S					*			

Suspension set

Wire suspension

S10F

Height adjustability: On the luminaire
 Suspension length (SH): 1500, 3000, 5000 mm
 Cap colour: White / Black

S10C

Gripper position: On the ceiling
 Suspension length (SH): 1500, 3000, 5000 mm
 Cap colour: White / Black / Nickel

S12FH

Height adjustability: On the luminaire
 Suspension length (SH): 1500, 3000, 5000 mm
 Cap colour: White / Black

Cap

White cap **Black cap**

Y wire suspension

S10Y2

Suspension length (SH): 1500, 3000, 5000 mm
 Cap colour: White / Black

S12Y3

Suspension length (SH): 1500, 3000, 5000 mm
 Cap colour: White / Black

201/Demi

Suspension length (SH): 1500 mm
 Cap colour: White

Suspension rod

Fiber carbon rod

Suspension length (SH): 500 - 2000 mm
 Carbon rod colour: Black

Suspension rod

Suspension length (SH): 500, 750, 1500, 2000 mm
 Cable: With / Without
 Ceiling cup and rod colour: White / Black

Ceiling cup with wire suspension

RH250C

Power cable suspension height (SH): 1500, 3000, 5000 mm
 Power cable colour: Transparent
 Ceiling cup colour: White / Black

Chain suspension set

Chain suspension set

Suspension length (SH): 2000 mm

Y chain suspension set

Suspension length (SH): 4000 mm

Brackets

Bracket with pigtail

Available for: Sequal



















Suspension sets by products

	Wire suspension			With remote driver position			Ceiling cup with wire susp.	Suspension rod		Chain suspension set		
	S10C	S10F	S12FH	S10Y2	S12Y3	Demi/216	RH 250 C	Fiber carbon rod	Suspension rod	Suspension rod with cable	Suspension set 2m	Suspension set 4m
Pixy								*				
Dawn	✓											
Black Hole			*				*					
Futon	✓											
Lysabel	*											
Issa		*										
Pipes Tube		✓										
Eyen		✓										
Vitka	✓											
Gramm								*				
Glazer	*											
Minus	*											
Night & Day	✓											
Mocca	✓											
Camay	✓											
Kalis	Kalis 55 S	Kalis 65 CS/SDI							*	*		
Random		*							*	*		
Hexagon		*							*	*		
Rylo Pro		*							*	*		
Lynar		*							*	*		
Trix		*							*	*		
Gyon		*							*	*		
Wave		*							*	*		
Wave Round		*					up to 1520 mm		*	*		
Acousto		*					Acousto Round		*	*		
Sword		*										
Rylo		*										
Pipes	✓											
Nola		*										
Lona		*			d.400/600 H100		d.900/1200 H120					
Karo	✓											
Skyler	✓			✓								
Canvas	*											
Demi				SDI		*						
106&216						*						
Sequal		*		2+2 / 3+3 IP65					*		*	2+2 / 3+3 IP65
Arago												*
5700											*	

Suspended on the power cable	
Biba	✓
Zoe	✓
Hunter	✓

✓ included * order separately

Symbol explanation

	Simple and fast construction with Intra Constructor PRO		Casambi module integrated for wireless light control with smart devices
	The product is 90% or more recyclable		Intended for indoor use
	An integral part of the lamp is a sound absorber that improves acoustics		Intended for outdoor use
	Tunable white: from cool white to warm white (2700 - 6500 K)		Resistant to different weather conditions
	Dim to warm: dimming down the intensity changes the CCT from 2900K down to 2200K		Intended for medical use (Hospital equipment)
	Vivid COB: For more brilliant & attractive display		Ballproof option in accordance with DIN 18032-3 and DIN EN 13964
	RGB dynamic colour illumination		CE Certificate
	Risk group 0: no risk whatever the observation time of the source		ENEC Certificate
	Risk group 1 (low risk): maximum exposure time of 10,000 s (3 h)		7-year Warranty

Legal notes

We have carefully checked all technical data. Please consider that errors may occur. We also reserve the right to modify anything anytime in the interest of constant progress and technology improvements. Therefore, for the latest product information, please browse our website. We will carry out all orders following the relevant versions of our General Terms and Conditions, also available on the website.

Imprint

Design: Intra lighting
Text: Intra lighting, I&S Aladin
Product photos: Andraž Jenkole, AV Studio, Dragan Arrigler, Ikon
Product Visualisation: Studio Spacer, Grafik Fanatik, Tronog
Print: Florjančič tisk

Made in Slovenia, June / 2022
 Copyright © Intra lighting d.o.o.
 All rights reserved

Product developed within EUREKA program, co-founded by MGRT, Spirit

Project name	Product group
LED DWL	Nitor, Narro, Pipes RV, Pipes RIO/RVO
OPTI-LED	Sequal, Demi HMP, Miva HMP, Gyon HMP (lens development)
Medis	Medis
Linear light system	Tracker



Intra Constructors PRO

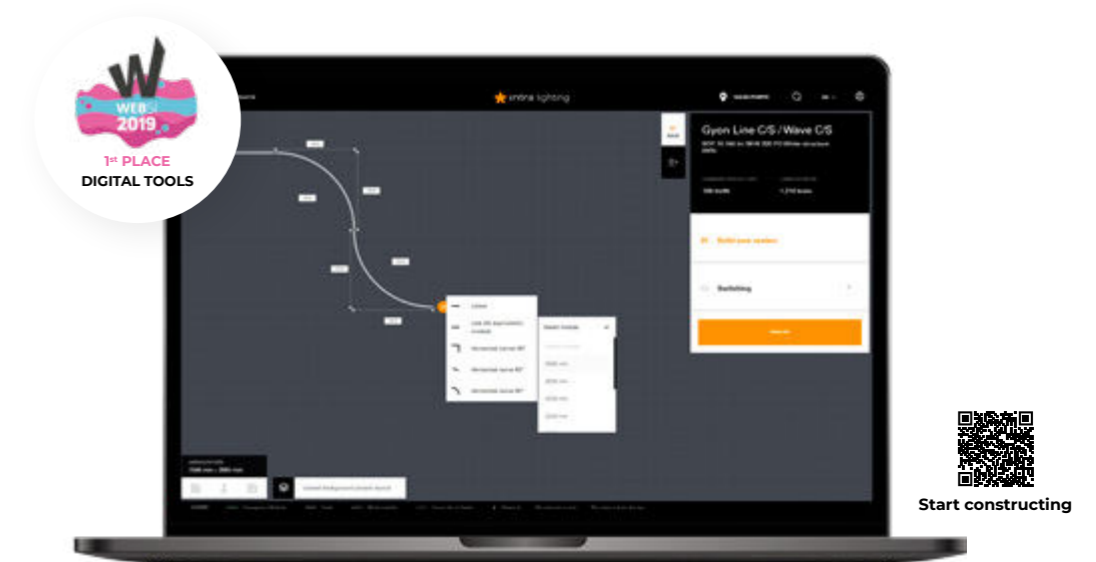

Construct lighting systems with a speed of light

It's simple, precise and finalised in less than a minute. You can design basic or custom system shapes entirely on your own. The user-friendly tool offers a wide selection of product families and modules. Forgetting the product parts will be history.

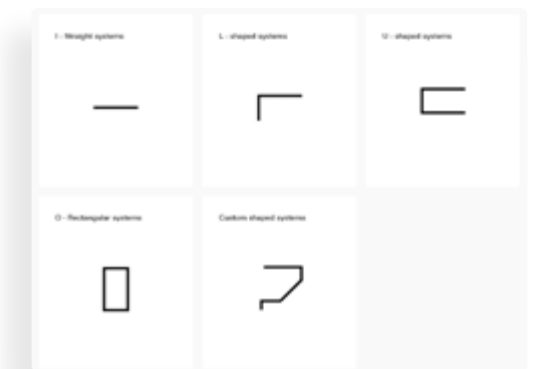

Technical documentation

You can download, print out or save all the technical documentation; that is much more than a list of codes and modules. You'll get only one code for the whole system, containing all the essential information together with the price (for registered partners only).



Just a click away

EASY TO FIND

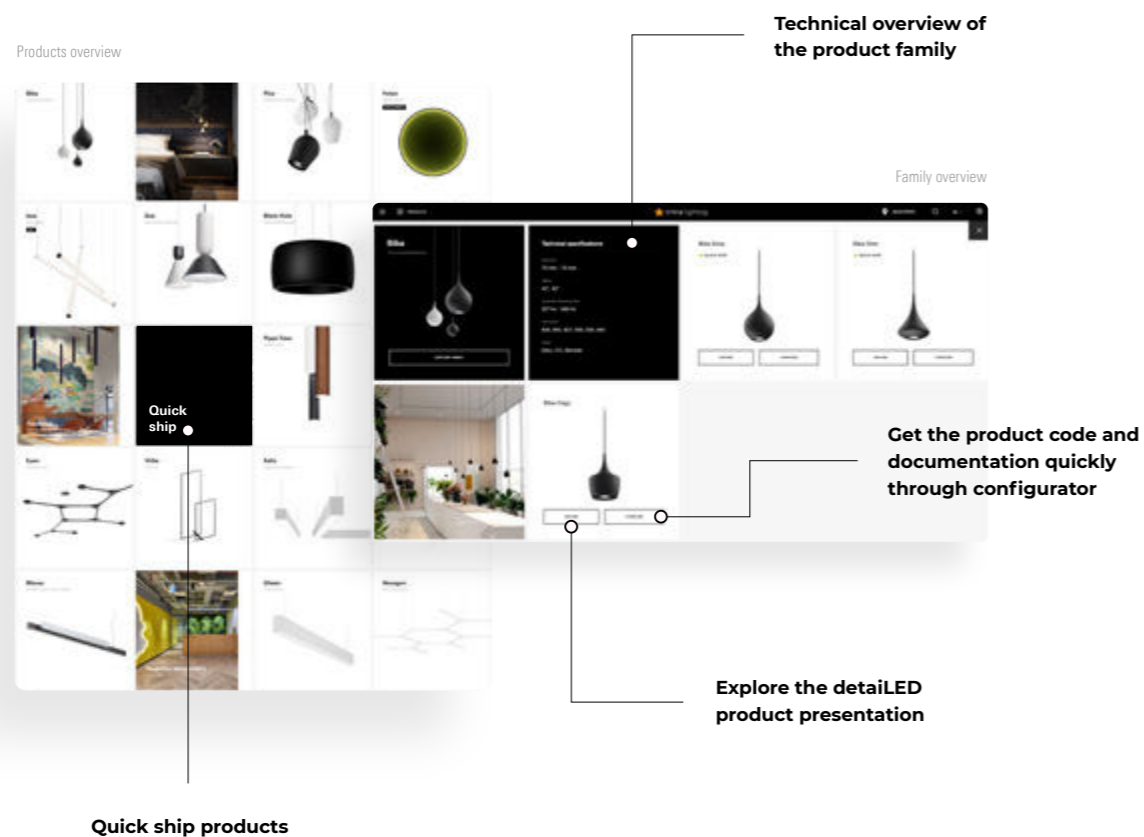

Browse also offline

You can get all the product presentations in only one download and then browse through them quickly and easily also offline.

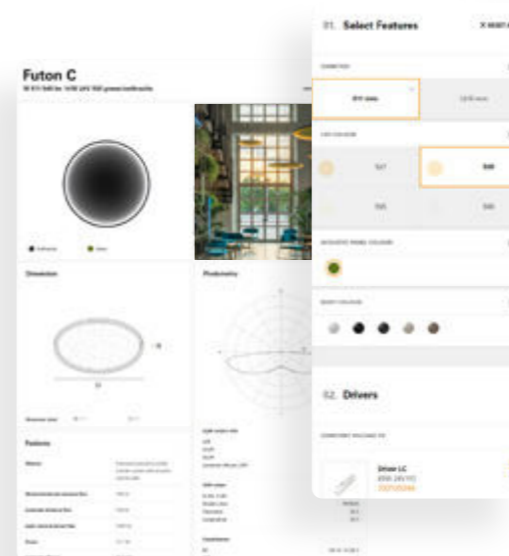
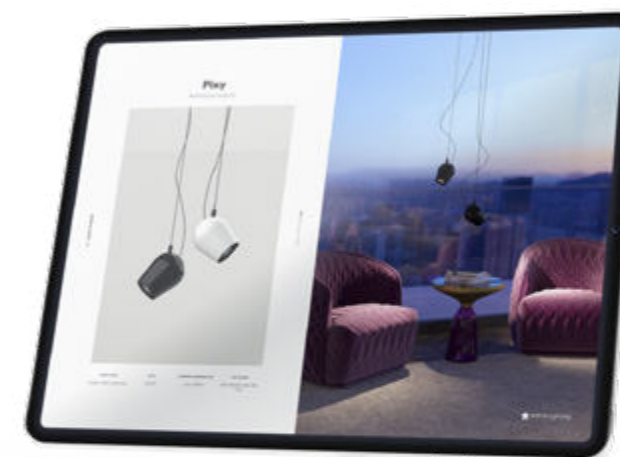

Intra Configurator

Intra Configurator is an easy, fast and accurate tool, with simple feature selection. Its role is to prevent all the mistakes that could be done while planning. Every product also gets its own technical card and all the necessary documentation downloads.



The best online lighting experience

Visit our website to comprehend the portfolio quickly, discover the novelties, and find the product you are looking for. There are different ways to find inspiration for your projects. The user experience is simple, fast and intuitive. Make a click!

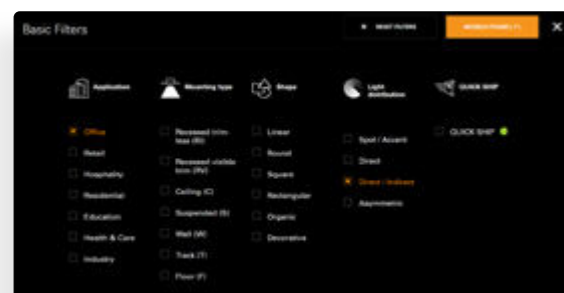

Find the product in less than a minute!

There are many ways to find a product. Search visually by family or models. Or technically by filters, defining a specific feature or installation type. There is also a Quick ship filter available.

EASY TO LOVE

Happy to be part of your projects

We're proud to collaborate with architects, designers, companies and individuals to create innovative projects and solutions that showcase light in all its functionality and aesthetics.



We love light



Sunlight is our inspiration

Light brings life

Spaces where everything feels right, have their reason behind. Every single day we search for new and better, future-proof and sustainable lighting solutions for living spaces, to create light that enhances well-being and makes people feel good.

Come with us. Bring your ideas to life.



Headquarters in Slovenia



In 2019 more than 350 employees from nine countries came to Slovenia to celebrate the 30th anniversary.

Human is always at the forefront

At Intra lighting, focus on the human, is not only an innovative approach, dictated by the market needs. Putting people to the forefront means appreciating employees, partners and clients at everyday work and intertwining of different interests. Considering their well-being and time.

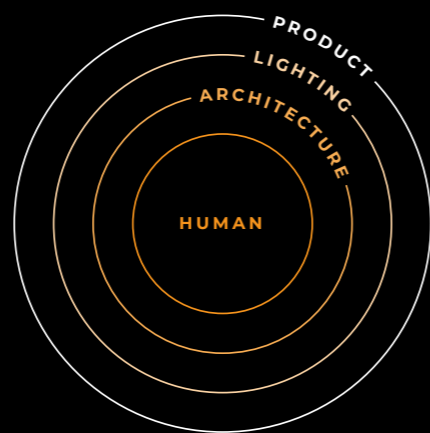

We are all Intra

All of us, every day, each in its area, contribute to growing together. We value diversity and encourage inclusion. Our employees differ across nationalities, ages, and gender.



We speak 13 languages.



Employee care is one of the highest priorities.



Corporate video



Marino, Marjeta, Nika and Anej Furlan. The company is family owned. The love for life is being passed from one generation to another.



Intra lighting family



Customer training is well accepted.

The team behind the brand

Our highly qualified and experienced team and associated partners can follow different project typologies, support you through every phase of the project realization and help you with all the information you may need. We speak 13 languages and the universal one: passion.

33+ years 60+ countries 350+ employees

Made in Europe

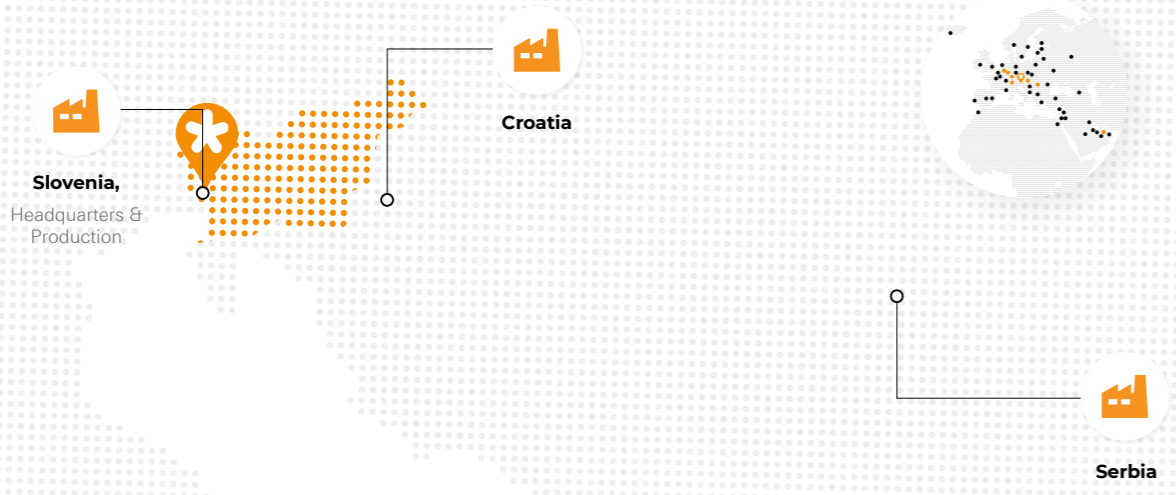

Quality in every detail

Our products are thoughtfully designed, manufactured and tested in order to ensure reliable operation throughout their life span, strongly limit the environmental impact and co-create pleasant living conditions. Quality is one of our highest priorities and a way of life.



State of the art production

With a new production process, we have reduced energy consumption, raw materials, natural resources and waste. We introduced an automated vertical storage system, a modern powder coating system and an automated guided vehicle for flexible internal logistics.



Solar panels generate enough energy to run the factory and HQ autonomously.



Safe and comfortable working environment



Modern powder coating system with low water and energy consumption, pre-treatment tunnel with passivation (corrosion protection), and automated powder application with a recovery system.



Automated guided vehicle for flexible internal logistics



Automated vertical storage system



Turn-mill center with collaborative robot

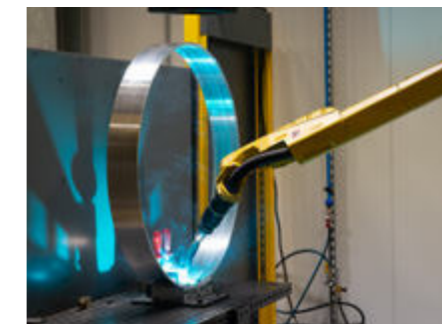

Robotic Welding Systems



All the products are 100% tested in our own lab, one of the biggest in Europe.

7 year warranty **24** thousand m² **ISO** certified productions

We care for the environment

We have always been ahead of time.

We lived and acted sustainably before the word sustainability became synonymous with responsible behaviour towards the environment and people. A concern for what kind of world we will leave to our children has always been present in everything we do. We were not guided by regulations; we were guided by conscience and consciousness.

We are present globally but always closely connected to the local environment.

100% 93% 10+

sustainable energy*

product recyclability

years of product life

*HQ and factory in Slovenia.

Light where it is needed, when it is needed and as much as needed.

Since 2014

With light, we improve people's lives and their well-being.

The light, in all its forms, can make a difference. We have the vision to create light that enhances well-being and makes people feel good. Stimulate their power and creativity and make them enjoy all the benefits of a well-planned illumination with light where it is needed when it is needed and as much as needed.

Products that last in time

Their main sustainable characteristics are high quality, long lifespan, long-lasting design, and low energy consumption. Our products are already highly recyclable, easy to assemble and disassemble. They are flexible, so they can adapt to changing demands and needs.

We are constantly implementing many sustainable phases of product life-cycle management, planning to extend our activities.

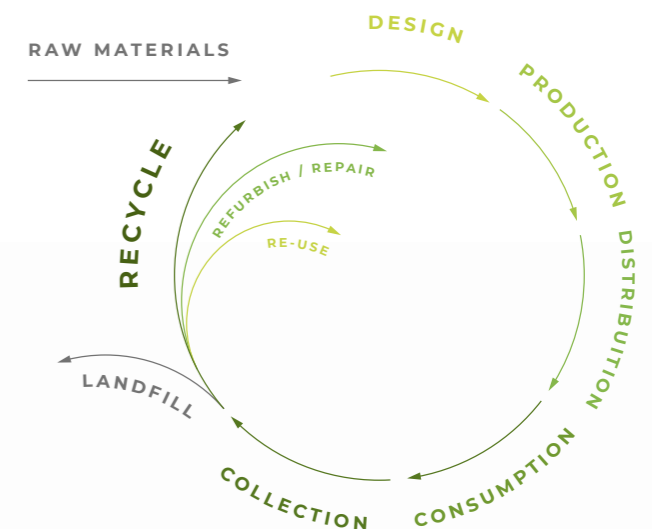

OUR SUSTAINABLE STEPS TOWARDS A BETTER FUTURE

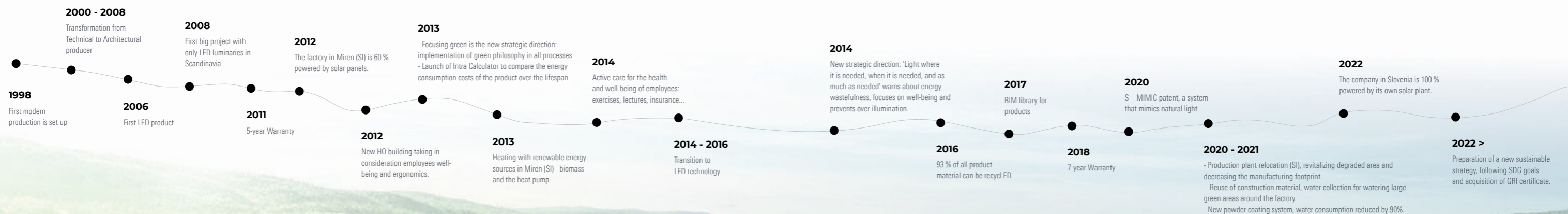

Passion for local worldwide

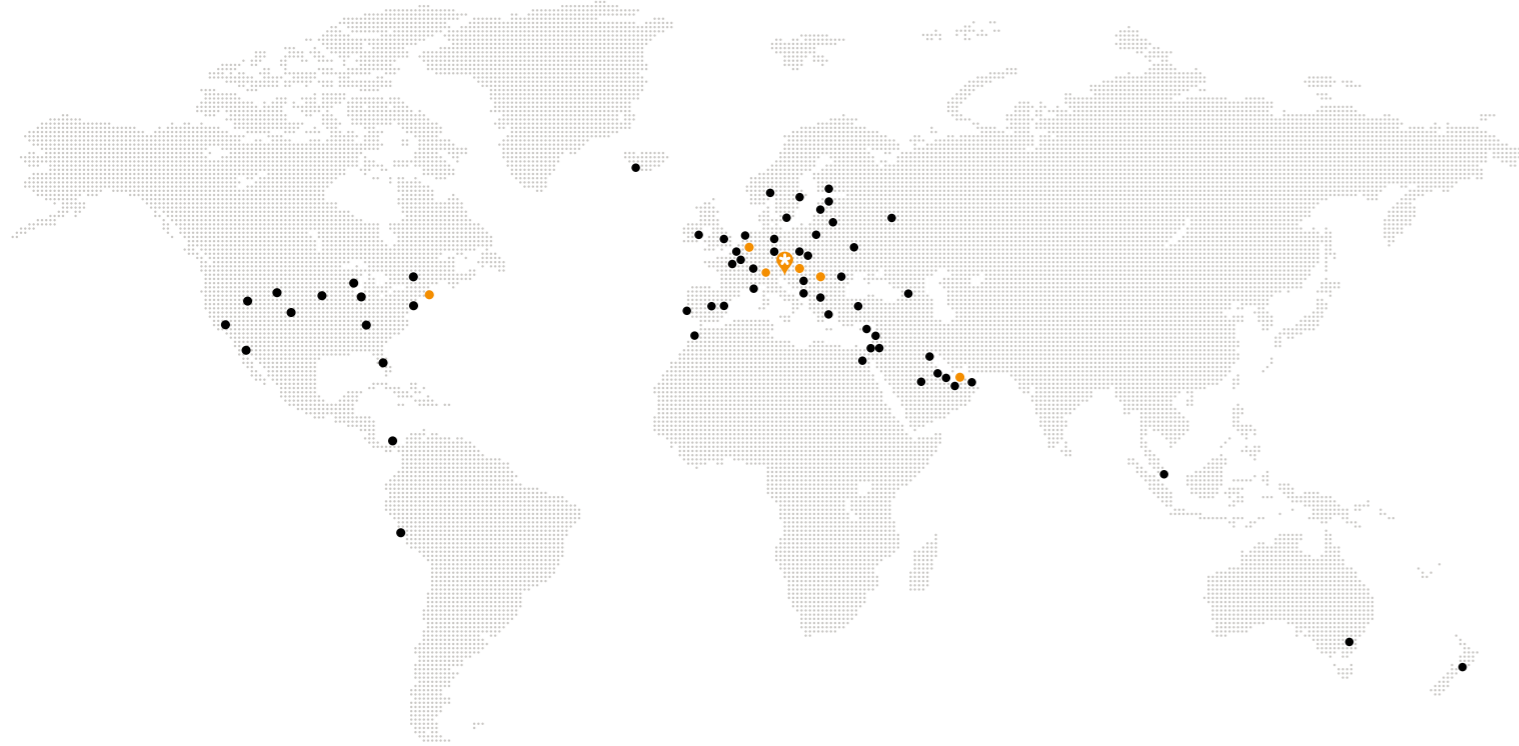

Let's work together

Headquarters

Intra lighting d.o.o.
 Vrtojbenska cesta 50
 5290 Šempeter pri Gorici,
 Slovenija
 T: +386 5 398 44 00
 E: info@intra-lighting.com
 www.intra-lighting.com

Follow us on

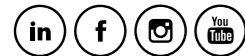

Find us on



Offices

**Benelux
 Intra lighting Benelux B.V.**
 Gildenstraat 26
 4143 HS Leerdam
 T: +31 345 623 678
 E: sales@intra-lighting.nl

**Bosna and Herzegovina
 Intra lighting d.o.o.**
 Hasana Brkića 30
 71000 Sarajevo
 T: +387 33 642 841
 E: info@intra-lighting.com

**Croatia
 Intra lighting d.o.o.**
 Ulica grada Vukovara 269d
 10000 Zagreb
 T: +385 1 6389 141
 E: info@intra-lighting.com

**Italy
 Intra lighting S.r.l.**
 Via Adelaide Bono Cairoli 30
 20127 Milano
 T: +39 02 9176 1234 / 42
 E: info@intra-lighting.com

**North America
 Intra lighting US, LLC**
 227 W 29th Street, 12th Floor
 New York, NY 10001
 T: 215-918-4199
 M: 215-388-1800
 E: info.us@intra-lighting.com

**Serbia
 Intra lighting d.o.o. Beograd**
 Omladinskih brigada 90B
 Airport City
 11070 Novi Beograd
 T: +381 11 269 8 476
 E: info@intra-lighting.com

**Slovenia
 Intra lighting d.o.o.**
 BTC, PTC Diamant
 Letališka 5
 1000 Ljubljana
 T: +386 1 547 65 30
 E: info@intra-lighting.com

**United Arab Emirates
 Intra lighting Middle East**
 Office 5WB 241, Building 5WB
 Dubai Airport Freezone, Dubai
 T: +971 502426911
 E: info@intra-lighting.com



Sales point

Pick your colour



Select from colours to match your style.

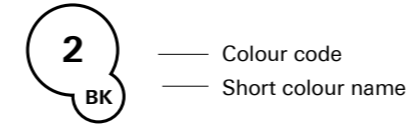

COATED



Gold coated



Bronze coated



Onyx coated



White



Black



Anthracite



Silver Aluminium



Driftwood

STRUCTURAL

MATTE

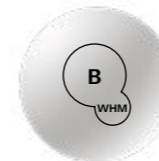

Matte White



Matte Black



Matte Concrete Grey



Matte Gold

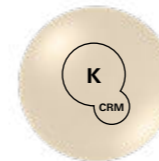

Matte Cream*



Matte Camel*



Matte Terracotta*



Matte Green Pine*



Matte Twilight Blue*

GLOSS



Gloss White



Gloss Black



Gloss Concrete Grey

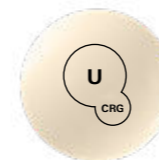

Gloss Cream*



Gloss Camel*



Gloss Terracotta*



Gloss Green Pine*



Gloss Twilight Blue*

For colour option range on specific family check the online Product Configurator.
 The colour representation is indicative. For the correct colour representation refer to the Intra lighting colour demo set. Custom RAL colours available upon request.
 *Colours marked with X are part of a special collection.



“You have to do something unexpected,
something that everybody thought was impossible.”

Marino Furlan, Co-founder and President