

FLOS

WORKING CATALOGUE 2022

DEUTSCH / ENGLISH



Dieser Marker erscheint in den Produktneigkeiten / This marker appears alongside Product News

INDEX

LIGHT STRUCTURES

12 – Belt



● 16 – Infra-Structure



30 – Infra-Structure
Episode 2



40 – Diversion



54 – Zero Track

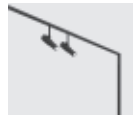

68 – The Micro Running
Magnet



● 84 – The Running Magnet



● 108 – The Tracking Magnet



130 – The Tracking Power



● 144 – The Fast Track



154 – In-Finity



164 – LED Squad /
LED Squad Mini



170 – Light Cut Mini



HIGH COMFORT

● 178 – Oblique Floor



180 – Oblique



● 182 – Light Shadow



● 268 – Light Shadow Pro /
Light Shadow Dots



282 – Circle of Light



286 – LED Curtain



INDEX

DOWNLIGHTS

292 – Kap



402 – Bon Jour



306 – Light Shooter



414 – Light Sniper



420 – UT Downlight



428 – Light Supply



440 – Pure Downlight



446 – Compass



DOWNLIGHTS

452 – Anthony Downlight



454 – Wan Downlight



456 – Johnny



468 – Compass Box Recessed



472 – Battery

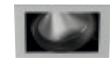

480 – Micro Battery



INDEX

SPOTLIGHTS

486 – Camera



494 – Find Me



500 – UT Spot&Pro



518 – Solid Pure



528 – Pure Spot



540 – Wan Spot



542 – Fort Knox



CEILING / WALL

• 548 – C1



556 – UT Pro Surface



560 – Kap Surface /
Kap Suspension



570 – Compass Box



• 576 – Super Line /
Super Line Pro



582 – Super Flat



588 – Light Bell



• 592 – Fort Knox Wall /
Fort Knox Wall Mini



594 – Thin LED



596 – Wall System



602 – G-O



604 – TheBlockofLight



INDEX

SOFT - LINEAR

631 - Wall Rupture



632 - Softprofile



634 - Kapprofile



SOFT - 3D

639 - Juncos



641 - Wall Piercing



645 - Soft Spun



646 - Abajourd'Hui



SOFT - OUT

649 - USO Boob



651 - USL Out



SOFT - IN

655 - APPS



657 - G-O IN



657 - Teardrop



658 - USO



662 - USO Cove Lighting



665 - Round Light



666 - Square Light



667 - Vertical Light



667 - USB Round



668 - USB Square



INDEX

606 - TRACKS

612 - DRIVERS

618 - LIGHT SOURCES

620 - TECHNICAL INFORMATION











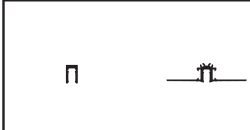

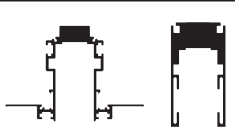



































674 - QUICK SEARCH OF PRODUCT

702 - DISTRIBUTION

LIGHT STRUCTURES

Belt, Infra-Structure, Infra-Structure
Episode 2, Diversion, Zero Track, The Micro
Running Magnet, The Running Magnet,
The Tracking Magnet, The Tracking Power,
The Fast Track, In-Finity, LED Squad,
Light Cut Mini.

LIGHT STRUCTURES OVERVIEW

		MICRO RUNNING MAGNET		RUNNING MAGNET			FAST TRACK		
									
PHYSICAL CHARACTERISTICS	MOUNTING	SURFACE	RECESSED	RECESSED	SURFACE	SUSPENSION Down / Up & Down	RECESSED	SURFACE	
	COLORS								
	VOLTAGE / TRACK ADAPTER	24 Vdc In-Track		24 Vdc In-Track			48 Vdc In-Track		
	INNER GAP (mm)	5		35			35		
	OUTER GAP (mm)	-	9	-	41		-	49	
	RECESSED DEPTH (mm)	-	17	73,5	-	-	73,5	-	
	HEIGHT (mm)	14	-	86 / 73	100	100	86 / 73	92	
	LENGTH (mm)	1000 / 2000 / 3000		1000 / 1500 / 2000 / 2500 / 3000			1000 / 1500 / 2000 / 3000		
	PROFILE EMISSION	 (Direct emission & Wall-Washer by means of dedicated light modules)		 (Upper emission integrated / direct emission by means of dedicated light modules)					
CONTROL CHARACTERISTICS	NON DIMMABLE								
	DALI								
	CASAMBI	 (Individual control integrated)		 (Individual control integrated)			 (Individual control integrated)		
	1 - 10V								
	PUSH								
	MAIN DIMMING								
	UP&DOWN (Indep)	—					—		
COMPATIBLE LIGHT MODULES	ACCENT LIGHTING	Nano Spot  Micro Spot 	Light Shadow Spot  Spot 	Spot Module  Multi Spot 4 	Spot 120  Light Shadow / Wall-Washer 	Anthony Spot Track  Find Me Suspension 	Spot 100  Spot 175 	Spot 120 	
	DIFFUSED LIGHTING	Light Stripe Diffused  Light Stripe Wall-Washer 		Light Stripe  String Light Ball 	Mini Glo-Ball  String Light Cone 	Mini Glo-Ball Suspension 			

LIGHT STRUCTURES OVERVIEW

TRACKING MAGNET			INFRA-STRUCTURE	INFRA-STRUCTURE EPISODE 2	DIVERSION		ZERO TRACK	TRACKING POWER	
RECESSED	SUSP / SURF Down	SUSPENSION Up & Down	SUSPENSION	SURFACE	SURFACE	SUSPENSION	SURFACE	RECESSED	SURFACE
48 Vdc In-Track			48 Vdc In-Track	48 Vdc	24 Vdc In-Track		24 Vdc In-Track	240 / 220 Vac In-Track	
15			15	-	12		8	15	
-	25		30	-	16		17	15	
31,5	-	-	-	-	-		-	24,5	-
45 / 31	46	52	100 / 300 400 / 700	100 / 200 / 400 600 / 800 / 1000	7		7	37 / 24	32
1000 / 1500 / 2000 / 2500 / 3000			1100 / 1600	900 / 1200 / 1500	1000 / 1500 / 2000 / 2500		1000 / 2000 / 3000	1000 / 2000 / 3000 / 4000	1000 / 2000 / 3000
✓ (Upper emission integrated / direct emission by means of dedicated light modules)			✗ (Requires dedicated light modules)	✗ (Requires dedicated light modules)	✓ (Down / Up - Down emission)		-	✗	
✓			✓	✓	✓		✓	✗	
✓			✓	✓	✓		✓	✓ (Only Wall-Washer)	
✓ (Individual control integrated)			✓ (Individual control integrated)	✓ (Broadcast control)	✓ (Individual control integrated)		✓ (Individual control integrated)	✗	
✓			✓	✓	✓		✓	✗	
✗			✗	✓	✗		✗	✗	
✗			✗	✗	✗		✗	✗	
✓			✓	✓	Up 50%		-	-	
Spot 50	Spot 90	Spot 120	Spot 150	Atom 90		Atom 120	Find Me 0	UT Pro 150	UT Pro 175
Anthony Spot Track				Find Me 1		Find Me 2	Find Me Suspension	UT Pro 175 Lens	
				Camera 60		Camera 90			
Light Stripe	Wallee	Suspension Glass Downlight 110		Light Tube Covered		Atom 200		UT Pro Wall-Washer	
		Suspension Panel 600		Suspension Cone 300 / 400					
		Light Tube Direct / Indirect / Blind		Suspension Panel 600					
				Light Tube Direct / Indirect					

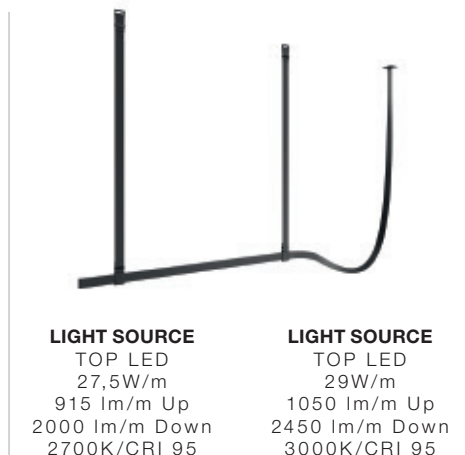

LIGHT SOURCE
TOP LED
27,5W/m
915 lm/m Up
2000 lm/m Down
2700K/CRI 95

LIGHT SOURCE
TOP LED
29W/m
1050 lm/m Up
2450 lm/m Down
3000K/CRI 95

■ GN Grün
GN Green

■ 18 Natürliches Leder
18 Natural Leather

■ 14 Schwarz
14 Black



Produktbeschreibung

Dieses ikonische Profil für die hängende Installation zeichnet sich durch eine exklusive Lederausstattung aus, die speziell für Flos Architectural entwickelt wurde, um die Sicherheits- und Reinlichkeitsanforderungen öffentlicher und privater Umgebungen zu erfüllen.

Der Gürtel ist pure Flexibilität, eine geschwungene Linie, deren Art im Gleichgewicht zwischen der Weichheit des Leders und der Steifigkeit des Aluminiums steht. Das weiche Element wird durch die Verbindung zum elektrischen Netz dargestellt, während die starren Teile den Lichtquellen der langen Lichtleitungen entsprechen. Jedes Profil verfügt über eine integrierte Beleuchtung mit direktem und indirektem Licht und jede Emission kann einzeln per Fernsteuerung gesteuert werden.

Das Produkt wird mithilfe von Lederbändern installiert, mit denen das Beleuchtungsprofil aufgehängt wird, indem sie durch spezielle Metallschnallen geschoben werden, die als Deckenhalterungen dienen. Jedes Band kann angepasst werden, um die Beschaffenheit der Umgebung zu berücksichtigen.

Mit dem speziellen Mikroanschluss, der in die Klemme des Beleuchtungsprofils integriert ist, kann die elektrische Verbindung durch einfaches Klicken hergestellt werden. Das Verbindungselement ist in der Lederschleife versteckt, die als Aufhängung zur Unterstützung der Einheit dient.

Profile mit Längen von 2 und 3 m mit Oberflächen in schwarzer bzw. grüner Farbe oder mit natürlichem Leder erhältlich.

Optisches System

Lineares Up&Down-Profil - direkte/indirekte Emission: Allgemeine Beleuchtung.

Einspeisung

Das System kann nur mit einer externen Stromquelle betrieben werden, die nicht in den Profilen enthalten ist. Empfohlene Treiber sind separat zu bestellen.

Regulierungssystem

Dimmbares System mit 1–10V-, DALI- oder CASAMBI-Controller, das in der Leuchte integriert ist. Individuelle direkte und indirekte Emissionen können durch ein Casambi- oder DALI-Steuersystem reguliert werden.

Zusatzinformationen

Elektrische Anlage wird mit 48 V.
Schutzgrad IP20.
Auf normal entflammaren Oberflächen einsetzbar.

Qualitätszeichen

Das Gerät entspricht der europäischen technischen Norm EN60598-1 und den entsprechenden Zusatzregelungen.

Description

This iconic profile for suspended installation features a refined leather surface developed specifically for Flos Architectural to respond to the needs of safety and cleanliness in public and private environments.

Belt is pure flexibility, a sinuous line that creates a balance between the softness of leather and the rigidity of aluminium. The soft part is represented by the connection to the electrical network, while the rigid parts correspond to the light source, the long lines of light.

Each profile is equipped with integrated direct and indirect lighting and each light source can be controlled individually via remote control.

The product is installed with the use of leather straps to hang the lighting profile, sliding the straps through dedicated metal clasps that act as hooks on the ceiling. Each strap may be regulated to match the shape of the environment.

A special microconnector integrated into the terminal of the lighting profile allows for electrical connection through a simple snap. The electrical connection is hidden within the leather strap, which supports the composition. Profiles available with 2- and 3-m lengths in black, natural leather, and green finishes.

Optic system

Linear Up&Down profile – direct/indirect emission: General Lighting.

Power Supply

The system may be powered only with remote power sources not included with the profiles. Recommended drivers sold separately.

Regulation System

Dimmable system with 1–10 V, DALI, or CASAMBI controller integrated inside the fixture. Individual direct and indirect emission may be regulated through a Casambi or DALI control system.

Additional Information

Electrical system powered at 48V.
IP20 protection grade.
Suitable for installation on normally inflammable surfaces.

Standard Compliance and Quality Marks

EN60598-1 European Technical Standards and any subsequent additions.

BELT – LIGHT MODULE STRUCTURE

Belt

Light Source: Top LED 27,5W/m - 915 lm/m UP - 2000 lm/m DOWN - 2700K/CRI 95 / 27,5W/m - 1050 lm/m UP - 2450 lm/m DOWN - 3000K/CRI 95

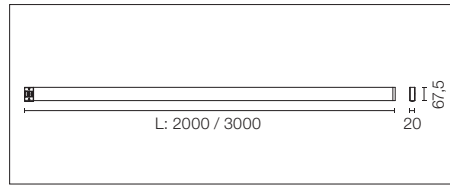

Elektromechanisches Profil für Innenräume mit integrierter linearer Beleuchtung für hängende Installationen mit einer Länge von 2 bis 3 m erhältlich. Installation über Deckenaufhängungsbänder und externes Netzteil, das separat zu bestellen ist. Up&Down-System über DALI gesteuert oder CASAMBI einzeln und über 1-10V zusammen (Broadcast).

Electromechanical profile for interior use with integrated linear lighting for suspended installation available with 2 or 3 m lengths. Installation via suspension straps on the ceiling and remote power kit, to be ordered separately. Up&Down system controlled via DALI or CASAMBI individually and via 1-10V all together (Broadcast).

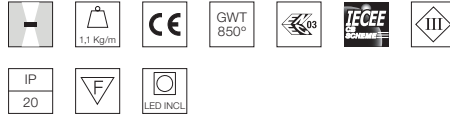

2700K

L: 2000 mm

Dali Version

- 03.8500.GN.DA
- 03.8500.18.DA
- 03.8500.14.DA

1-10V (Broadcast)

- 03.8500.GN.1V
- 03.8500.18.1V
- 03.8500.14.1V
- Casambi integrated
- 03.8500.GN.CB
- 03.8500.18.CB
- 03.8500.14.CB

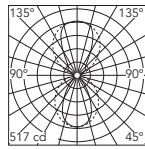

Beam Angle: 60°

h(m)	E(lx)	D(m)
1	517	1.16
2	129	2.31
3	57	3.47
4	32	4.63
5	21	5.79

Luminous flux luminaire
1694 lm

3000K

L: 2000 mm

Dali Version

- 03.8505.GN.DA
- 03.8505.18.DA
- 03.8505.14.DA

1-10V (Broadcast)

- 03.8505.GN.1V
- 03.8505.18.1V
- 03.8505.14.1V
- Casambi integrated
- 03.8505.GN.CB
- 03.8505.18.CB
- 03.8505.14.CB

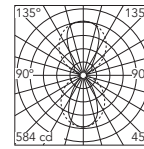

Beam Angle: 60°

h(m)	E(lx)	D(m)
1	584	1.16
2	146	2.31
3	65	3.47
4	37	4.63
5	23	5.79

Luminous flux luminaire
1915 lm

2700K

L: 3000 mm

Dali Version

- 03.8501.GN.DA
- 03.8501.18.DA
- 03.8501.14.DA

1-10V (Broadcast)

- 03.8501.GN.1V
- 03.8501.18.1V
- 03.8501.14.1V
- Casambi integrated
- 03.8501.GN.CB
- 03.8501.18.CB
- 03.8501.14.CB

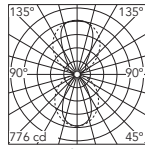

Beam Angle: 60°

h(m)	E(lx)	D(m)
1	776	1.16
2	194	2.31
3	86	3.47
4	48	4.63
5	31	5.79

Luminous flux luminaire
2542 lm

3000K

L: 3000 mm

Dali Version

- 03.8506.GN.DA
- 03.8506.18.DA
- 03.8506.14.DA

1-10V (Broadcast)

- 03.8506.GN.1V
- 03.8506.18.1V
- 03.8506.14.1V
- Casambi integrated
- 03.8506.GN.CB
- 03.8506.18.CB
- 03.8506.14.CB

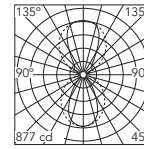

Beam Angle: 60°

h(m)	E(lx)	D(m)
1	877	1.16
2	219	2.31
3	97	3.47
4	55	4.63
5	35	5.79

Luminous flux luminaire
2872 lm

BELT – INSTALLATION

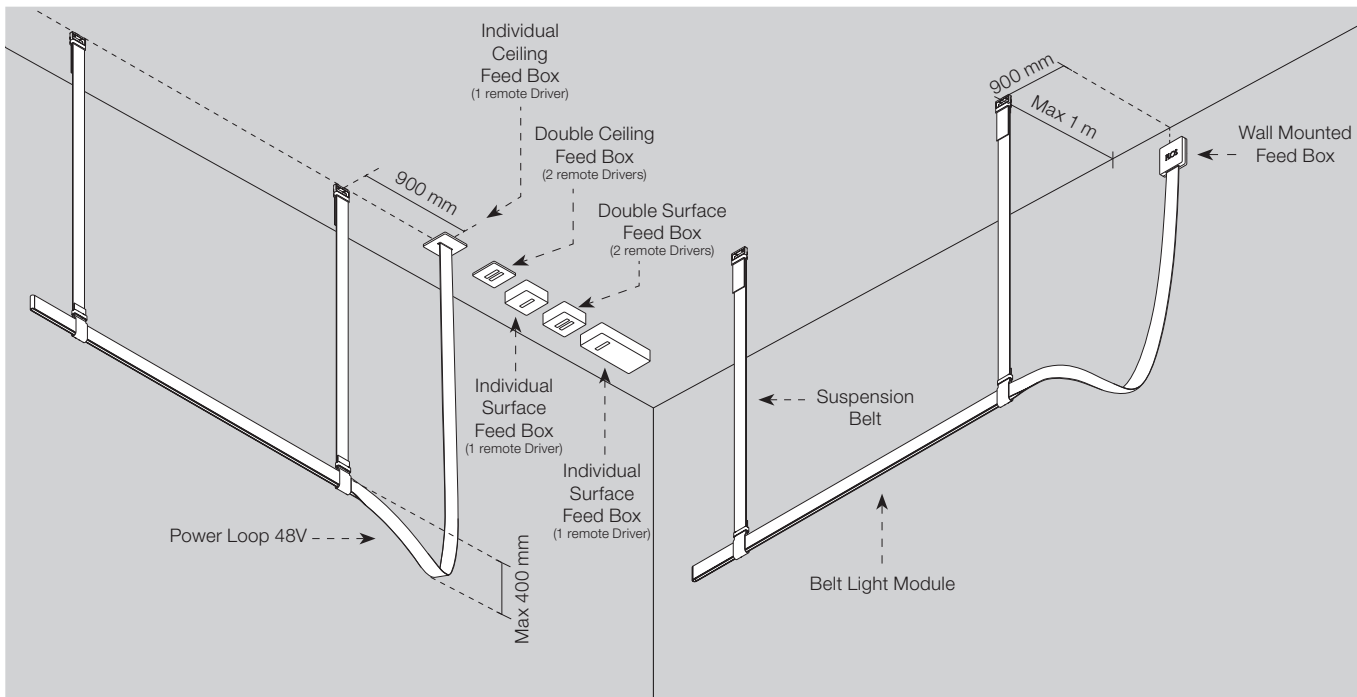

Zubehör / Accessories

Aufhängungsgurt. 2 Stück.

Accessori / Accessories

Suspension strap. 2 units.

Suspension Strap (mm)	Power Loop (mm)
1000	1500
1500	2500
2000	
2500	3500
3000	



- L: 1000 mm
- 03.8510.GN
- 03.8510.18
- 03.8510.14
- L: 1500 mm
- 03.8513.GN
- 03.8513.18
- 03.8513.14
- L: 2000 mm
- 03.8511.GN
- 03.8511.18
- 03.8511.14
- L: 2500 mm
- 03.8514.GN
- 03.8514.18
- 03.8514.14
- L: 3000 mm
- 03.8512.GN
- 03.8512.18
- 03.8512.14

Stromschleife, 48 V.

48-V power loop.

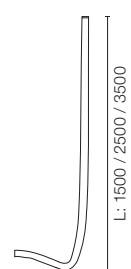





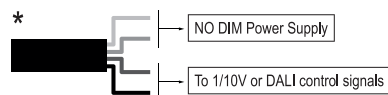
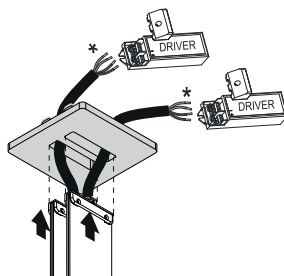
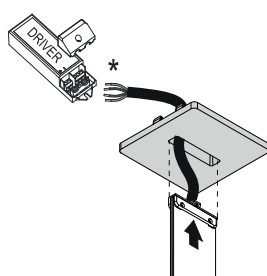



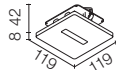

- L: 1500 mm
- 03.8520.GN
- 03.8520.18
- 03.8520.14
- L: 2500 mm
- 03.8521.GN
- 03.8521.18
- 03.8521.14
- L: 3500 mm
- 03.8522.GN
- 03.8522.18
- 03.8522.14

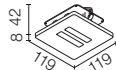
Remote Driver Installations



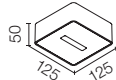

BELT

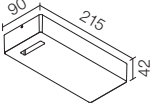
Zubehör / Accessories

Individuelles Deckennetzteil. Treiber nicht enthalten.	Individual ceiling feed box. Driver not included.			08.0180.00
Doppeltes Deckennetzteil. Treiber nicht enthalten.	Double ceiling feed box. Driver not included.			08.0181.00
Individuelles Wandnetzteil. Parallel zum Profil zu installieren. Treiber nicht enthalten.	Wall mounted feed box. To be install in parallel to the Belt profile. Driver not included.			08.0182.00
Individueller Oberflächeneinspeisekasten. Treiber nicht enthalten.	Individual surface feed box. Driver not included.			08.0194.00
Doppelter Oberflächeneinlaufkasten. Treiber nicht enthalten.	Double surface feed box. Driver not included.			08.0195.00
Oberflächen-Treiberbox 96W - 48V, 110-240V.	Surface driver box 96W - 48V, 110-240V.			06.0173.14

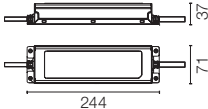
Treiber / Drivers

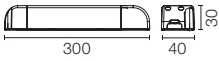
LED-Netzteil für Ferninstallation 110Vac-135W / 220Vac-200W.	LED power supply source for remote installation, 110Vac-135W / 220Vac-200W.			*60.9607
LED-Netzteil für Ferninstallation 48V/120W. 220/240 Vac.	LED power supply source for remote installation, 48V/120W. 220/240 Vac.			*60.9170

* Bei der Dimensionierung der Anlage ist eine Sicherheitsspanne von 15 % der maximalen Leistung der LED-Stromversorgung einzuhalten / For the sizing of the installation keep a safety margin of 15% of the maximum power of the LED power source.

INFRA-STRUCTURE

DESIGNED BY VINCENT VAN DUYSSEN

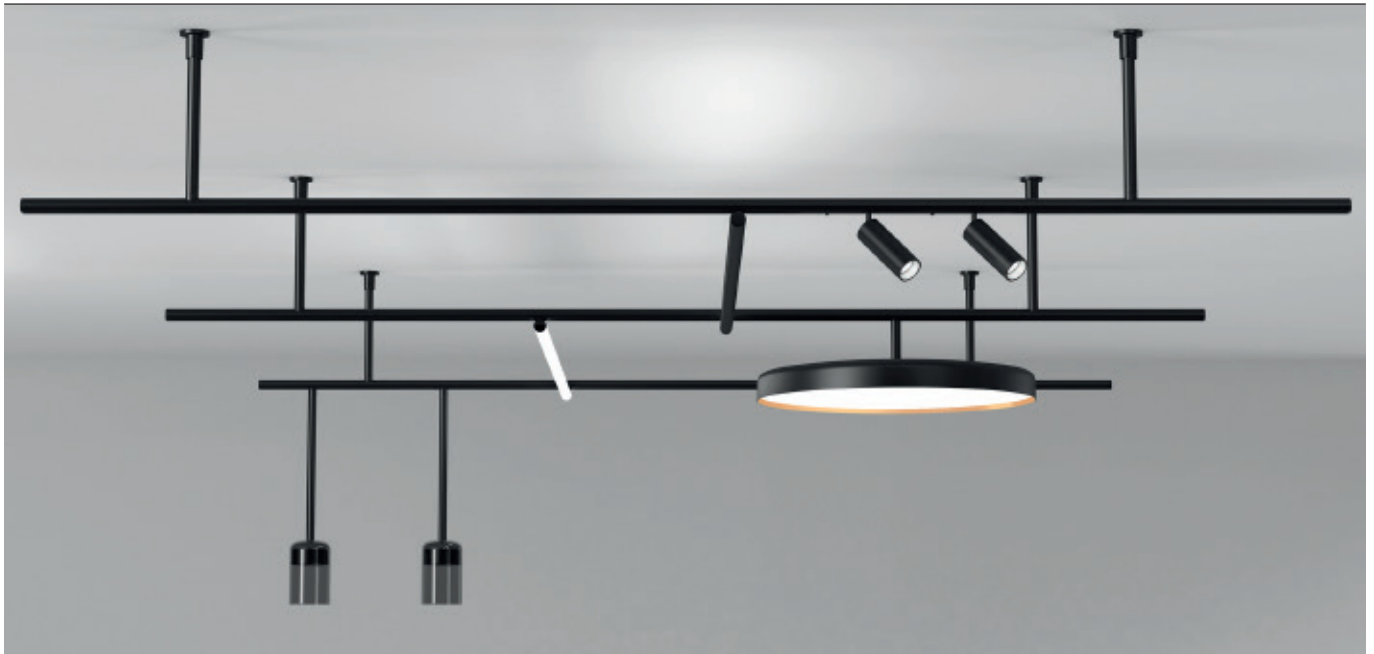

Profiles 40 Weiss
40 White 14 Schwarz
14 Black

LIGHT MODULES

LIGHT TUBE DIRECT-INDIRECT



LIGHT SOURCE
TOP LED
25W/m
1978 lm/m
2700K/CRI 90
2227 lm/m
3000K/CRI 90

SPOT 50



LIGHT SOURCE
POWER LED
3,5W
286 lm
2700K/CRI 90
307 lm
3000K/CRI 90

SPOT 90



LIGHT SOURCE
POWER LED
8,5W
610 lm
2700K/CRI 90
656 lm
3000K/CRI 90

SPOT 120



LIGHT SOURCE
POWER LED
12W
724 lm
2700K/CRI 90
779 lm
3000K/CRI 90

SPOT 120



LIGHT SOURCE
LED ARRAY
12,5W
1075 lm
2700K/CRI 90
1138 lm
3000K/CRI 90

SPOT 150



LIGHT SOURCE
LED ARRAY
22,5W
2000 lm
2700K/CRI 90
2115 lm
3000K/CRI 90

SUSPENSION PANEL 600



LIGHT SOURCE
TOP LED
40W
3195 lm
2700K/CRI 90
3381 lm
3000K/CRI 90

SUSPENSION GLASS DOWNLIGHT 110



LIGHT SOURCE
LED ARRAY
13,5W
1296 lm
2700K/CRI 90
1371 lm
3000K/CRI 90

MULTIFUNCTION SMART DEVICE



FLOS CONTROL®
by Casambi

Produktbeschreibung

Innovatives Beleuchtungssystem, das von Vincent Van Duysen zur oberflächlichen Installation an der Decke mittels starren und verstellbaren Stangen entworfen wurde.

Bei dieser überarbeiteten Version geht FLOS neben der bekannten Version "On Board Dimmer" einen Schritt weiter und präsentiert sowohl Profile als auch Leuchten, die mit verschiedenen Fernsteuerungssystemen gesteuert werden können: DALI, 1-10V und Casambi.

Beide Konstruktionsprofile werden rohrförmig aus extrudiertem Aluminium in schwarzer oder weißer Farbe hergestellt. Diese sind mit elektrischen Schienen ausgestattet, die mit 48 V versorgt werden. Die systemgesteuerten Versionen (DALI, 1-10V) sind mit einem Datenbus aus Graphit zur Regulierung ausgestattet. Casambi-Versionen sind mit allen Profilen kompatibel.

Die Leuchten werden mit einem magnetischen Befestigungs- und einem mechanischen Sicherheitssystem montiert.

Die Produktgruppe der Leuchten besteht aus Akzentbeleuchtungseinheiten in unterschiedlicher Optik, Umgebungsbeleuchtungsanlagen mit direktem und indirektem Licht und dekorativen Leuchten mit unverwechselbarem Design von Flos. Sämtliche Leuchten sind mit eingebautem Potentiometer erhältlich, dimmbar mit DALI oder 1-10V zur Regulierung der Lichtstärke, und bei der Casambi-Version für eine kabellose Regulierung.

Steuerung

- Für Leuchtenmontagen mit Dimmer "On Board Dimmer" und FLOS-Steuerung ist das Profil in der Version "On Board Dimmer" zu verwenden.

DALI- und 1-10V-Leuchten sind nur mit den Profilversionen DALI und 1-10V kompatibel.

Casambi-Leuchten sind mit allen Profilen kompatibel.

- Für die Steuerung mittels DALI-Protokoll muss der Steuerdatenbus direkt mit dem Profil verbunden werden.

- Für die Steuerung mittels 1-10V muss das Steuerungssystem aktiviert sein und der Steuerdatenbus muss direkt mit dem Profil verbunden werden.

In diesem Fall erfolgt das Dimmen bei allen verbundenen Leuchten einheitlich.

- Für die Steuerung mittels Casambi (max. 200 Leuchten) müssen Casambi-Leuchten bestellt werden, diese sind mit allen für das System verfügbaren Profilen kompatibel.

Für Mobilgeräte ist die App FLOS Control® powered by Casambi erforderlich (erhältlich im Apple Store und auf Google Play).

Maximale Anzahl der Schienenverbindungen, um die Signalübermittlung von DALI oder 1-10V zu gewährleisten: 20 Verbindungen.

Optisches System

- Light Tube Direct / Light Tube Indirect / Suspension Glass Downlight 110 / Suspension Panel 600: diffuses indirektes Raumlicht.

- Spot 50: Medium.

- Spot 90: Spot, Medium.

- Spot 120 Power LED (Gleiche Lichtquelle der Spot 50 und Spot 90): Spot, Medium.

- Spot 120 LED Array (Gleiche Lichtquelle des Spot 150): Medium, Flood.

- Spot 150: Spot, Medium, Flood.

Einspeisung

Fern-Netzteil 48V nicht enthalten. Max 6A - 320W.

Zubehör

Das Abschirmzubehör (Honeycomb und Querabschirmung) der Spot Beleuchtungsmodule ist im Produkt eingebaut.

Zusatzinformationen

Schutzgrad IP20.

Auf normal entflammaren Oberflächen einsetzbar.

Qualitätszeichen

Das Gerät entspricht der europäischen technischen Norm EN60598-1 und den entsprechenden Zusatzregelungen.

Description

Groundbreaking lighting system designed by Vincent Van Duysen for surface installation on ceiling with rigid and adjustable rods.

In the new proposal, beside the successful "On Board Dimmer" version, FLOS goes one step beyond, launching both track and luminaires designed for system management in a variety of options: DALI, 1-10V and Casambi.

Both profile version are manufactured with aluminium profiling extruded in white or black, provided with electric tracks powered at 48V.

The system controlled versions (DALI, 1-10V) are also equipped with graphite data bus for regulation.

The LED light fixtures are installed by means of a magnetic fixture system with mechanical safety fastening.

The light fixtures product group is composed of accent lighting modules with different optics, direct and indirect light ambient lighting systems and decorative light fixtures with the distinctive Flos design.

All light fixtures are available with potentiometer incorporated, dimmable DALI, 1-10V and Casambi to adjust the light intensity.

Control

- For installation of "On Board Dimmer" fixtures use "On Board Dimmer" track version.

Luminaires DALI and 1-10V are only compatible with track DALI and 1-10V.

Casambi luminaires can be installed on all profiles available in the system.

- To manage using DALI protocol, it is necessary to connect the control data bus directly to the profile.

- For 1-10V management, the control system must be active and the data bus must be connected directly to the profile. In this case, regulation will be uniform in all the connected luminaires.

- For Casambi management (Max. 200 luminaires) it is mandatory to use fixtures in the Casambi version, these are compatible with all profiles available in the system.

For managing and controlling the Casambi system, the FLOS Control® app powered by Casambi for mobile devices is necessary (available in the Apple Store and Google Play).

Maximum number of track interconnections to guarantee the communication of the DALI or 1-10V signal: 20 interconnections.

Optic system

- Light Tube Direct / Light Tube Indirect / Suspension Glass Downlight 110 / Suspension Panel 600: diffuse ambient light.

- Spot 50: Medium.

- Spot 90: Spot, Medium.

- Spot 120 Power LED (same light source as the Spot 50 and Spot 90): Spot, Medium.

- Spot 120 LED Array (same light source as the Spot 150): Medium, Flood.

- Spot 150: Spot, Medium, Flood.

Power Supply

Remote 48V power supply not included. Max 6A - 320W.

Accessories

For the Spot illumination modules, the cross-screening accessories (honeycomb and crosspieces) are incorporated into the product.

Additional Information

IP20 protection grade.

Suitable for installation on normally inflammable surfaces.

Compliance of Standards and Quality Marks

EN60598-1 European Technical Standards and any subsequent additions.

FLOS
CONTROL BY CASAMBI



INFRA-STRUCTURE – PROFILES

Profile

Rohr förmiges elektromagnetisches Profil für den Deckenaufbau mit starren und regulierbaren Stangen (25 mm). Starre, nicht regulierbare Stangen auf Anfrage erhältlich.

Profile und Endelemente sind in Versionen erhältlich, die mit den "On Board Dimmer" Leuchten und mit den systemgesteuerten (DALI, 1-10V, FLOS Control® by Casambi) Leuchten kompatibel sind.

Rohrprofile sind in zwei Längen verfügbar: 1055 mm (ergibt einen 1100 mm Abstand zwischen den Stangen) und 1555 mm (ergibt 1600 mm Abstand zwischen den Stangen).

Die Endelemente werden ebenfalls eingespeist und müssen separat bestellt werden.

Alle mechanischen und elektrischen Stangen sind für beide Versionen gleich und in verschiedenen Höhen erhältlich (100, 300, 400, 700 mm).

Verschiedene Ausführungen der Befestigungsstangen:

- Mechanische Stange mit Ø50 oder Ø140 Rosette : dient zur Befestigung von Profilen.
- Stromeinspeisungsstange mit Ø50 Rosette: Einspeisungsstange für den Einbau einer externen Versorgung an einer zugänglichen Stelle.
- Stromeinspeisungsstange mit Ø140 Rosette: Einspeisungsstange für den Einbau einer externen Versorgung an einer zugänglichen Stelle.
- Dateneinspeisungsstange mit Ø50 oder Ø140 Rosette: für den Anschluss an einen DALI oder 1-10V Bus.
- Aluminiumschablone zur Markierung der Befestigungspunkte für die Installation der Stangen separat erhältlich.

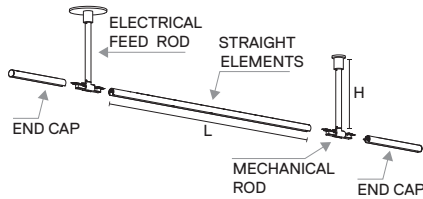

L: 1055 mm / 1555 mm

Profiles

Tubular electromagnetic profile for surface installation in ceilings through rigid and adjustable rods (25 mm). Not adjustable rigid rods available on request. Profiles and closure terminals are available in version compatible with luminaires "on board dimmer" and versions compatible with system controlled luminaires (DALI, 1-10V, FLOS Control® by Casambi).

Tubular profiles available in two lengths: 1055 mm (1100 mm separation between rods) and 1555 mm (1600 mm separation between rods).

The closure terminals will also be electrified and must be ordered separately. Mechanical and electrical rods are the same for the two profile versions and they are all available in multiple lengths (100, 300, 400, 700mm).

Different versions of fastening rods:

- Mechanic rod with a Ø50 or Ø140 connection rose: to fasten profiles.
- Electrical rod with a Ø50 connection rose: a supply rod for remote installation of the power supply in an accessible place.
- Electrical rod with a Ø140 connection rose: a supply rod for remote installation of the power supply through the connection rose.
- Data connection rod with a Ø50 or Ø140 connection rose: for connection to DALI or 1-10V bus signal.
- Aluminium stencil to mark the points for installing the rods available as separate item.

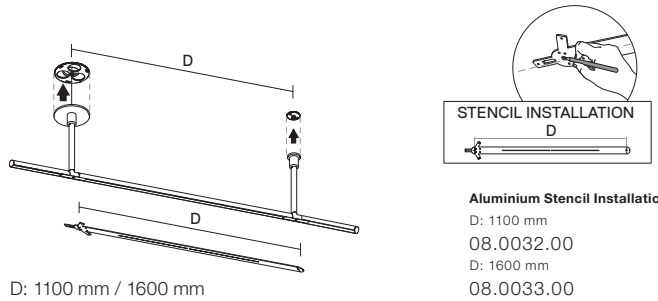

Gerade elemente.

Straight elements.

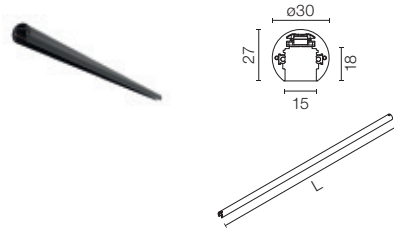

L: 1055 mm (D: 1100 mm)
L: 1555 mm (D: 1600 mm)

On board dimmer/
FLOS Control® by Casambi
compatible

L: 1055 mm
 06.5140.40
 06.5140.14

L: 1555 mm
 06.5141.40
 06.5141.14

DALI/1-10V/FLOS Control® by Casambi
compatible

L: 1055 mm
 06.5100.40
 06.5100.14

L: 1555 mm
 06.5101.40
 06.5101.14

Endkappe.

End cap.



On board dimmer/
FLOS Control® by Casambi
compatible

06.5142.40A
 06.5142.14A

DALI/1-10V/FLOS Control® by Casambi
compatible

06.5135.40A
 06.5135.14A

Stange mit mechanik rosette ø50 mm.
Einstellbar auf 25 mm, geeignet für unebene Dächer.

Mechanical rod rose ø50 mm.
Adjustable 25 mm, to adapt it to irregular ceilings.

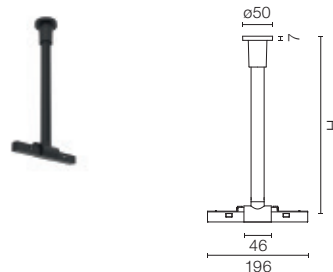

H: 100 mm
 06.5110.40
 06.5110.14

H: 300 mm
 06.5111.40
 06.5111.14

H: 400 mm
 06.5112.40
 06.5112.14

H: 700 mm
 06.5113.40
 06.5113.14

* Für bestehende Installationen / For existing installations.

INFRA-STRUCTURE – PROFILES

Stange mit stromeinspeisung rosette ø50 mm.
Einstellbar auf 25 mm, geeignet für unebene Dächer.

Electrical feed rod rose ø50 mm.
Adjustable 25 mm, to adapt it to irregular ceilings.

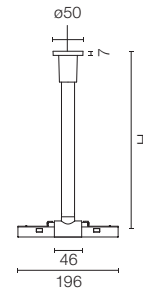

- H: 100 mm
- 06.5120.40
- 06.5120.14
- H: 300 mm
- 06.5121.40
- 06.5121.14
- H: 400 mm
- 06.5122.40
- 06.5122.14
- H: 700 mm
- 06.5123.40
- 06.5123.14

Dateneinspeisungsstange mit ø50 mm Rosette.
Es braucht eine pro Installationslinie, für den Anschluss an einen DALI oder 1-10V Bus.
Einstellbar auf 25 mm, geeignet für unebene Dächer.

Data connection rod rose ø50mm.
Use one for each line of the installation, for connection to DALI or 1-10V signal source.
Adjustable 25 mm, to adapt it to irregular ceilings.

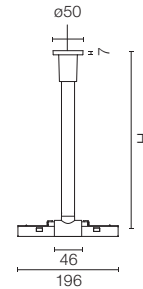

- H: 100 mm
- 06.5150.40
- 06.5150.14
- H: 300 mm
- 06.5151.40
- 06.5151.14
- H: 400 mm
- 06.5152.40
- 06.5152.14
- H: 700 mm
- 06.5153.40
- 06.5153.14

Stange mit mechanik rosette ø140 mm.
Einstellbar auf 25 mm, geeignet für unebene Dächer.

Mechanical rod rose ø140 mm.
Adjustable 25 mm, to adapt it to irregular ceilings.

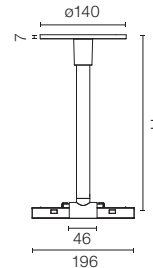

- H: 100 mm
- 06.5115.40
- 06.5115.14
- H: 300 mm
- 06.5116.40
- 06.5116.14
- H: 400 mm
- 06.5117.40
- 06.5117.14
- H: 700 mm
- 06.5118.40
- 06.5118.14

Stange mit stromeinspeisung rosette ø140 mm.
Einstellbar auf 25 mm, geeignet für unebene Dächer.

Electrical feed rod rose ø140 mm.
Adjustable 25 mm, to adapt it to irregular ceilings.

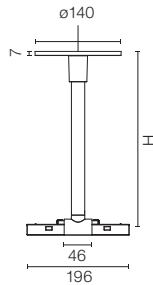

- H: 100 mm
- 06.5125.40
- 06.5125.14
- H: 300 mm
- 06.5126.40
- 06.5126.14
- H: 400 mm
- 06.5127.40
- 06.5127.14
- H: 700 mm
- 06.5128.40
- 06.5128.14

Dateneinspeisungsstange mit ø140 mm Rosette.
Es braucht eine pro Installationslinie, für den Anschluss an einen DALI oder 1-10V Bus.
Einstellbar auf 25 mm, geeignet für unebene Dächer.

Data connection rod rose ø140mm.
Use one for each line of the installation, for connection to DALI or 1-10V signal source.
Adjustable 25 mm, to adapt it to irregular ceilings.

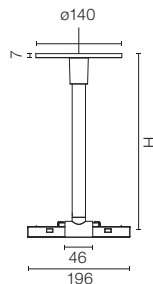

- H: 100 mm
- 06.5155.40
- 06.5155.14
- H: 300 mm
- 06.5156.40
- 06.5156.14
- H: 400 mm
- 06.5157.40
- 06.5157.14
- H: 700 mm
- 06.5158.40
- 06.5158.14

Blindrohr.

Blind tube.

Mechanisches Modul (ohne Beleuchtung) zum installieren in dem System Infra-Struktur. Drehbare Befestigungselemente 0°-90°, mit Magnetanschluß und mechanischer Sicherheitsblockierung, zum installieren quer zwischen zwei Profilleitungen.

A mechanical module (without lighting) to be installed in the system infrastructure. Fixing components that rotate 0°-90°, with a magnetic connection and a mechanical safety lock. To be installed transversely between two profile lines.

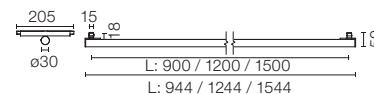

- L: 900 mm
- 03.8120.40
- 03.8120.14
- L: 1200 mm
- 03.8121.40
- 03.8121.14
- L: 1500 mm
- 03.8122.40
- 03.8122.14

INFRA-STRUCTURE – LIGHT MODULES

Light Tube ø30 Direct

Light Source: Top LED 25W/m - 1978 lm/m - 2700K/CRI 90 / 25W/m - 2227 lm/m - 3000K/CRI 90

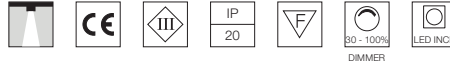
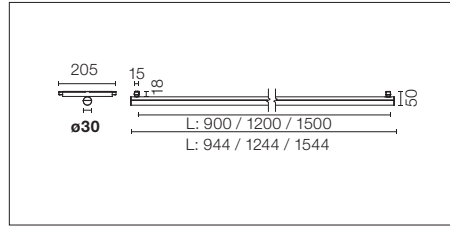

LED-Modul für diffuses Licht zur Installation in das System Infra-Structure.
 Befestigungselemente 0 bis 90 Grad drehbar, mit magnetischer Verbindung und mechanischem Sicherheitsbolzen für die Querverbindung zweier Streben.
 Die Light Tubes werden nur über ein Ende versorgt und geben über die andere Seite keinen Strom ab.
 Für die kabellose Steuerung der Leuchten sind die integrierten Casambi-Versionen auszuwählen.

Diffused LED light module to be installed in The Infra-Structure.
 System turning fastening elements 0°-90° with a magnetic connection and mechanic security bolt for a transversally installation between two lines of the profile.
 The Light Tube are only fed by one of the ends and do not communicate current through the other end.
 For wireless lighting control, choose integrated Casambi versions.

- 2700K**
 L: 900 mm - 23W - 1820 lm
 On board dimmer
 03.8100.40
 03.8100.14
 *Dali Version
 03.8100.40.DA
 03.8100.14.DA
 *1-10V
 03.8100.40.1V
 03.8100.14.1V
 **Casambi integrated
 03.8100.40.CB
 03.8100.14.CB

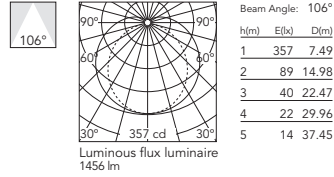

- 3000K**
 L: 900 mm - 23W - 2048 lm
 On board dimmer
 03.8105.40
 03.8105.14
 *Dali Version
 03.8105.40.DA
 03.8105.14.DA
 *1-10V
 03.8105.40.1V
 03.8105.14.1V
 **Casambi integrated
 03.8105.40.CB
 03.8105.14.CB

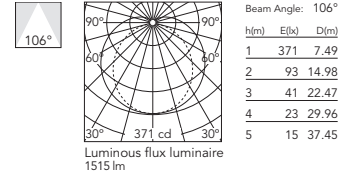

- 2700K**
 L: 1200 mm - 30W - 2366 lm
 On board dimmer
 03.8101.40
 03.8101.14
 *Dali Version
 03.8101.40.DA
 03.8101.14.DA
 *1-10V
 03.8101.40.1V
 03.8101.14.1V
 **Casambi integrated
 03.8101.40.CB
 03.8101.14.CB

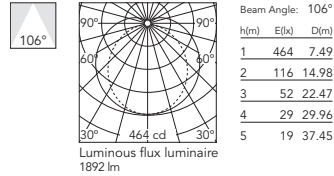

- 3000K**
 L: 1200 mm - 30W - 2663 lm
 On board dimmer
 03.8106.40
 03.8106.14
 *Dali Version
 03.8106.40.DA
 03.8106.14.DA
 *1-10V
 03.8106.40.1V
 03.8106.14.1V
 **Casambi integrated
 03.8106.40.CB
 03.8106.14.CB

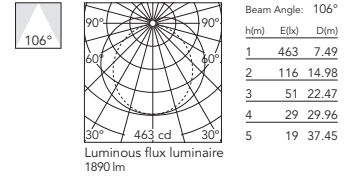

- 2700K**
 L: 1500 mm - 38W - 2912 lm
 On board dimmer
 03.8102.40
 03.8102.14
 *Dali Version
 03.8102.40.DA
 03.8102.14.DA
 *1-10V
 03.8102.40.1V
 03.8102.14.1V
 **Casambi integrated
 03.8102.40.CB
 03.8102.14.CB

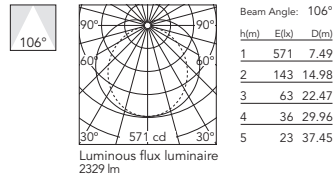

- 3000K**
 L: 1500 mm - 38W - 3278 lm
 On board dimmer
 03.8107.40
 03.8107.14
 *Dali Version
 03.8107.40.DA
 03.8107.14.DA
 *1-10V
 03.8107.40.1V
 03.8107.14.1V
 **Casambi integrated
 03.8107.40.CB
 03.8107.14.CB

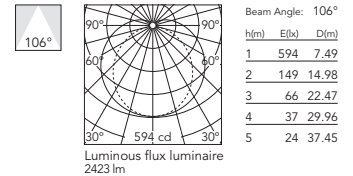

* Nur mit der Profiversion DALI, 1-10V kompatibel / Only compatible with DALI, 1-10V profile version .

** Die Steuerung bei den Casambi-Leuchten erfolgt direkt und individuell kabellos mittels der App FLOS Control® powered by Casambi / The control system with the Casambi version of light fixtures is directly and individually regulated wirelessly using the application FLOS Control® by Casambi.

INFRA-STRUCTURE – LIGHT MODULES

Light Tube ø30 Indirect

Light Source: Top LED 25W/m - 1978 lm/m - 2700K/CRI 90 / 25W/m - 2227 lm/m - 3000K/CRI 90

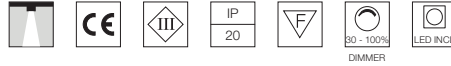
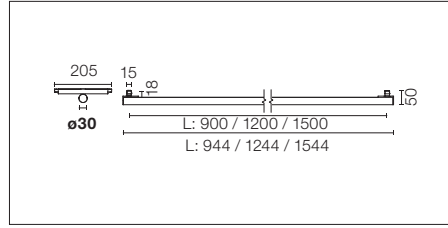

LED-Modul für diffuses Licht zur Installation in das System Infra-Structure.
 Befestigungselemente 0 bis 90 Grad drehbar, mit magnetischer Verbindung und mechanischem Sicherheitsbolzen für die Querverbindung zweier Streben.
 Die Light Tubes werden nur über ein Ende versorgt und geben über die andere Seite keinen Strom ab.
 Für die kabellose Steuerung der Leuchten sind die integrierten Casambi-Versionen auszuwählen.

Diffused LED light module to be installed in The Infra-Structure.
 System turning fastening elements 0°-90° with a magnetic connection and mechanic security bolt for a transversally installation between two lines of the profile.
 The Light Tube are only fed by one of the ends and do not communicate current through the other end.
 For wireless lighting control, choose integrated Casambi versions.

2700K

L: 900 mm - 23W - 1820 lm

On board dimmer

- ☐ 03.8110.40
- 03.8110.14
- *Dali Version
- ☐ 03.8110.40.DA
- 03.8110.14.DA
- *1-10V
- ☐ 03.8110.40.1V
- 03.8110.14.1V
- **Casambi integrated
- ☐ 03.8110.40.CB
- 03.8110.14.CB

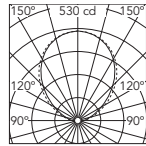

Beam Angle: 99°

h(m)	E(lx)	D(m)
1	530	2.12
2	133	4.25
3	59	6.37
4	33	8.50
5	21	10.62

Luminous flux luminaire 1239 lm

3000K

L: 900 mm - 23W - 2048 lm

On board dimmer

- ☐ 03.8115.40
- 03.8115.14
- *Dali Version
- ☐ 03.8115.40.DA
- 03.8115.14.DA
- *1-10V
- ☐ 03.8115.40.1V
- 03.8115.14.1V
- **Casambi integrated
- ☐ 03.8115.40.CB
- 03.8115.14.CB

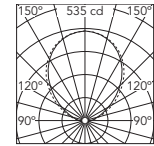

Beam Angle: 99°

h(m)	E(lx)	D(m)
1	535	2.12
2	134	4.25
3	59	6.37
4	33	8.50
5	21	10.62

Luminous flux luminaire 1249 lm

2700K

L: 1200 mm - 30W - 2366 lm

On board dimmer

- ☐ 03.8111.40
- 03.8111.14
- *Dali Version
- ☐ 03.8111.40.DA
- 03.8111.14.DA
- *1-10V
- ☐ 03.8111.40.1V
- 03.8111.14.1V
- **Casambi integrated
- ☐ 03.8111.40.CB
- 03.8111.14.CB

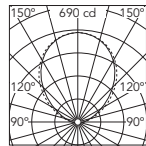

Beam Angle: 99°

h(m)	E(lx)	D(m)
1	690	2.12
2	173	4.25
3	77	6.37
4	43	8.50
5	28	10.62

Luminous flux luminaire 1612 lm

3000K

L: 1200 mm - 30W - 2663 lm

On board dimmer

- ☐ 03.8116.40
- 03.8116.14
- *Dali Version
- ☐ 03.8116.40.DA
- 03.8116.14.DA
- *1-10V
- ☐ 03.8116.40.1V
- 03.8116.14.1V
- **Casambi integrated
- ☐ 03.8116.40.CB
- 03.8116.14.CB

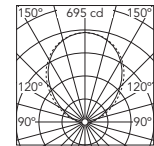

Beam Angle: 99°

h(m)	E(lx)	D(m)
1	695	2.12
2	174	4.25
3	77	6.37
4	43	8.50
5	28	10.62

Luminous flux luminaire 1624 lm

2700K

L: 1500 mm - 38W - 2912 lm

On board dimmer

- ☐ 03.8112.40
- 03.8112.14
- *Dali Version
- ☐ 03.8112.40.DA
- 03.8112.14.DA
- *1-10V
- ☐ 03.8112.40.1V
- 03.8112.14.1V
- **Casambi integrated
- ☐ 03.8112.40.CB
- 03.8112.14.CB

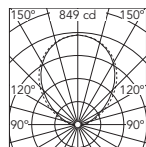

Beam Angle: 99°

h(m)	E(lx)	D(m)
1	849	2.12
2	212	4.25
3	94	6.37
4	53	8.50
5	34	10.62

Luminous flux luminaire 1984 lm

3000K

L: 1500 mm - 38W - 3278 lm

On board dimmer

- ☐ 03.8117.40
- 03.8117.14
- *Dali Version
- ☐ 03.8117.40.DA
- 03.8117.14.DA
- *1-10V
- ☐ 03.8117.40.1V
- 03.8117.14.1V
- **Casambi integrated
- ☐ 03.8117.40.CB
- 03.8117.14.CB

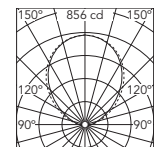

Beam Angle: 99°

h(m)	E(lx)	D(m)
1	856	2.12
2	214	4.25
3	95	6.37
4	53	8.50
5	34	10.62

Luminous flux luminaire 1999 lm

* Nur mit der Profiversion DALI, 1-10V kompatibel / Only compatible with DALI, 1-10V profile version .

** Die Steuerung bei den Casambi-Leuchten erfolgt direkt und individuell kabellos mittels der App FLOS Control® powered by Casambi / The control system with the Casambi version of light fixtures is directly and individually regulated wirelessly using the application FLOS Control® by Casambi.

INFRA-STRUCTURE – LIGHT MODULES

Spot 50

Light Source: Power LED 3,5W - 286 lm - 2700K/CRI 90 / 3,5W - 307 lm - 3000K/CRI 90

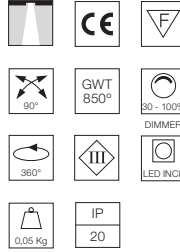
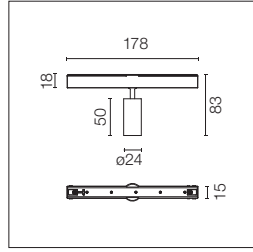

LED-Modul für Akzentbeleuchtung zur Installation in das System Infra-Structure.
Für die kabellose Steuerung der Leuchten sind die integrierten Casambi-Versionen auszuwählen.

Accent lighting LED module to be installed in The Infra-Structure System.
For wireless lighting control, choose integrated Casambi versions.

Inkludiertes Zubehör (Honeycomb und Blendschutzgitter).

Accessories included (honeycomb and screening crosspiece).

2700K

On board dimmer

- 03.8032.40A
- 03.8032.05A
- 03.8032.14A
- *Dali Version
- 03.8032.40ADA
- 03.8032.05ADA
- 03.8032.14ADA
- **1-10V
- 03.8032.40A1V
- 03.8032.05A1V
- 03.8032.14A1V
- **Casambi integrated
- 03.8032.40ACB
- 03.8032.05ACB
- 03.8032.14ACB

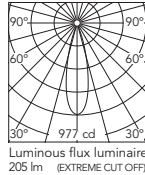

Beam Angle: 26°

h(m)	E(lx)	D(m)
1	977	0.47
2	244	0.94
3	109	1.41
4	61	1.88
5	39	2.35

Luminous flux luminaire
205 lm (EXTREME CUT OFF)

3000K

On board dimmer

- 03.8033.40A
- 03.8033.05A
- 03.8033.14A
- *Dali Version
- 03.8033.40ADA
- 03.8033.05ADA
- 03.8033.14ADA
- **1-10V
- 03.8033.40A1V
- 03.8033.05A1V
- 03.8033.14A1V
- **Casambi integrated
- 03.8033.40ACB
- 03.8033.05ACB
- 03.8033.14ACB

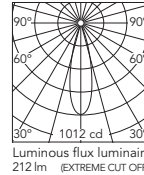

Beam Angle: 26°

h(m)	E(lx)	D(m)
1	1012	0.47
2	253	0.94
3	112	1.41
4	63	1.88
5	40	2.35

Luminous flux luminaire
212 lm (EXTREME CUT OFF)

* Nur mit der Profiversion DALI, 1-10V kompatibel / Only compatible with DALI, 1-10V profile version .

** Die Steuerung bei den Casambi-Leuchten erfolgt direkt und individuell kabellos mittels der App FLOS Control® powered by Casambi / The control system with the Casambi version of light fixtures is directly and individually regulated wirelessly using the application FLOS Control® by Casambi.

INFRA-STRUCTURE – LIGHT MODULES

Spot 90

Light Source: Power LED 8,5W - 610 lm - 2700K/CRI 90 / 8,5W - 656 lm - 3000K/CRI 90

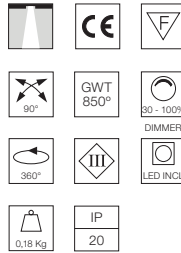
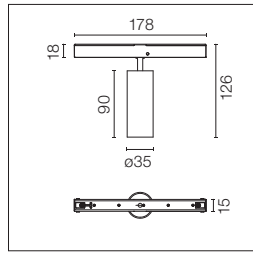

LED-Modul für Akzentbeleuchtung zur Installation in das System Infra-Structure.
Für die kabellose Steuerung der Leuchten sind die integrierten Casambi-Versionen auszuwählen.

Accent lighting LED module to be installed in The Infra-Structure System.
For wireless lighting control, choose integrated Casambi versions.

Inkludiertes Zubehör (Honeycomb und Blendschutzgitter).

Accessories included (honeycomb and screening crosspiece).

2700K

On board dimmer

- 03.8042.40A
- 03.8042.05A
- 03.8042.14A
- *Dali Version
- 03.8042.40ADA
- 03.8042.05ADA
- 03.8042.14ADA

*1-10V

- 03.8042.40A1V
- 03.8042.05A1V
- 03.8042.14A1V

**Casambi integrated

- 03.8042.40ACB
- 03.8042.05ACB
- 03.8042.14ACB

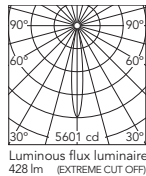

Beam Angle: 14°

h(m)	E(lx)	D(m)
1	5601	0.25
2	1400	0.49
3	622	0.74
4	350	0.98
5	224	1.23

3000K

On board dimmer

- 03.8043.40A
- 03.8043.05A
- 03.8043.14A
- *Dali Version
- 03.8043.40ADA
- 03.8043.05ADA
- 03.8043.14ADA

*1-10V

- 03.8043.40A1V
- 03.8043.05A1V
- 03.8043.14A1V

**Casambi integrated

- 03.8043.40ACB
- 03.8043.05ACB
- 03.8043.14ACB

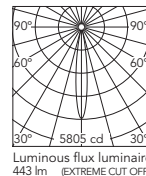

Beam Angle: 14°

h(m)	E(lx)	D(m)
1	5805	0.25
2	1451	0.49
3	645	0.74
4	363	0.98
5	232	1.23

2700K

On board dimmer

- 03.8044.40A
- 03.8044.05A
- 03.8044.14A
- *Dali Version
- 03.8044.40ADA
- 03.8044.05ADA
- 03.8044.14ADA

*1-10V

- 03.8044.40A1V
- 03.8044.05A1V
- 03.8044.14A1V

**Casambi integrated

- 03.8044.40ACB
- 03.8044.05ACB
- 03.8044.14ACB

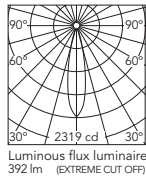

Beam Angle: 22°

h(m)	E(lx)	D(m)
1	2319	0.38
2	580	0.77
3	258	1.15
4	145	1.54
5	93	1.92

3000K

On board dimmer

- 03.8045.40A
- 03.8045.05A
- 03.8045.14A
- *Dali Version
- 03.8045.40ADA
- 03.8045.05ADA
- 03.8045.14ADA

*1-10V

- 03.8045.40A1V
- 03.8045.05A1V
- 03.8045.14A1V

**Casambi integrated

- 03.8045.40ACB
- 03.8045.05ACB
- 03.8045.14ACB

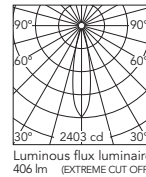

Beam Angle: 22°

h(m)	E(lx)	D(m)
1	2403	0.38
2	601	0.77
3	267	1.15
4	150	1.54
5	96	1.92

* Nur mit der Profilverision DALI, 1-10V kompatibel / Only compatible with DALI, 1-10V profile version .

** Die Steuerung bei den Casambi-Leuchten erfolgt direkt und individuell kabellos mittels der App FLOS Control® powered by Casambi / The control system with the Casambi version of light fixtures is directly and individually regulated wirelessly using the application FLOS Control® by Casambi.

INFRA-STRUCTURE – LIGHT MODULES

Spot 120

Light Source: Power LED 12W - 724 lm - 2700K/CRI 90 / 12W - 779 lm - 3000K/CRI 90

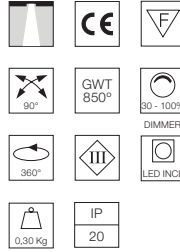
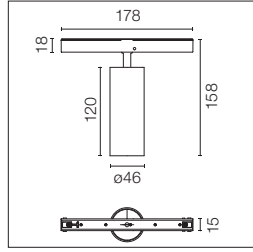

LED-Modul für Akzentbeleuchtung zur Installation in das System Infra-Structure.
Für die kabellose Steuerung der Leuchten sind die integrierten Casambi-Versionen auszuwählen.

Accent lighting LED module to be installed in The Infra-Structure System.
For wireless lighting control, choose integrated Casambi versions.

Inkludiertes Zubehör (Honeycomb und Blendschutzgitter).

Accessories included (honeycomb and screening crosspiece).

2700K

On board dimmer

- 03.8052.40A
- 03.8052.05A
- 03.8052.14A
- *Dali Version
- 03.8052.40ADA
- 03.8052.05ADA
- 03.8052.14ADA

*1-10V

- 03.8052.40A1V
- 03.8052.05A1V
- 03.8052.14A1V

**Casambi integrated

- 03.8052.40ACB
- 03.8052.05ACB
- 03.8052.14ACB

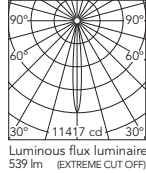

Beam Angle: 11°

h(m)	E(lx)	D(m)
1	11417	0.19
2	2854	0.37
3	1269	0.56
4	714	0.75
5	457	0.93

3000K

On board dimmer

- 03.8053.40A
- 03.8053.05A
- 03.8053.14A
- *Dali Version
- 03.8053.40ADA
- 03.8053.05ADA
- 03.8053.14ADA

*1-10V

- 03.8053.40A1V
- 03.8053.05A1V
- 03.8053.14A1V

**Casambi integrated

- 03.8053.40ACB
- 03.8053.05ACB
- 03.8053.14ACB

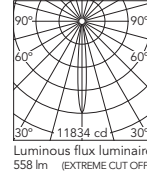

Beam Angle: 11°

h(m)	E(lx)	D(m)
1	11834	0.19
2	2958	0.37
3	1315	0.56
4	740	0.75
5	473	0.93

2700K

On board dimmer

- 03.8054.40A
- 03.8054.05A
- 03.8054.14A
- *Dali Version
- 03.8054.40ADA
- 03.8054.05ADA
- 03.8054.14ADA

*1-10V

- 03.8054.40A1V
- 03.8054.05A1V
- 03.8054.14A1V

**Casambi integrated

- 03.8054.40ACB
- 03.8054.05ACB
- 03.8054.14ACB

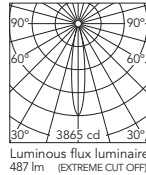

Beam Angle: 17°

h(m)	E(lx)	D(m)
1	3865	0.29
2	966	0.59
3	429	0.88
4	242	1.18
5	155	1.47

3000K

On board dimmer

- 03.8055.40A
- 03.8055.05A
- 03.8055.14A
- *Dali Version
- 03.8055.40ADA
- 03.8055.05ADA
- 03.8055.14ADA

*1-10V

- 03.8055.40A1V
- 03.8055.05A1V
- 03.8055.14A1V

**Casambi integrated

- 03.8055.40ACB
- 03.8055.05ACB
- 03.8055.14ACB

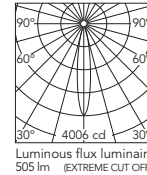

Beam Angle: 17°

h(m)	E(lx)	D(m)
1	4006	0.29
2	1001	0.59
3	445	0.88
4	250	1.18
5	160	1.47

* Nur mit der Profiversion DALI, 1-10V kompatibel / Only compatible with DALI, 1-10V profile version .

** Die Steuerung bei den Casambi-Leuchten erfolgt direkt und individuell kabellos mittels der App FLOS Control® powered by Casambi / The control system with the Casambi version of light fixtures is directly and individually regulated wirelessly using the application FLOS Control® by Casambi.

INFRA-STRUCTURE – LIGHT MODULES

Spot 120

Light Source: LED Array 12,5W - 1075 lm - 2700K/CRI 90 / 12,5W - 1138 lm - 3000K/CRI 90

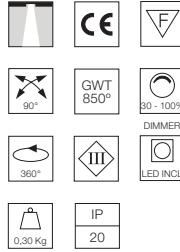
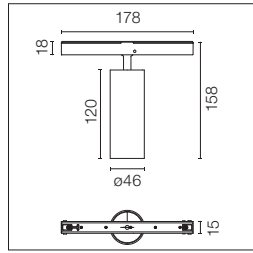

LED-Modul für Akzentbeleuchtung zur Installation in das System Infra-Structure.
Für die kabellose Steuerung der Leuchten sind die integrierten Casambi-Versionen auszuwählen.

Accent lighting LED module to be installed in The Infra-Structure System.
For wireless lighting control, choose integrated Casambi versions.

Inkludiertes Zubehör (Honeycomb und Blendschutzgitter).

Accessories included (honeycomb and screening crosspiece).

2700K

On board dimmer

- 03.8154.40
- 03.8154.05
- 03.8154.14
- *Dali Version
- 03.8154.40.DA
- 03.8154.05.DA
- 03.8154.14.DA

*1-10V

- 03.8154.40.1V
- 03.8154.05.1V
- 03.8154.14.1V

**Casambi integrated

- 03.8154.40.CB
- 03.8154.05.CB
- 03.8154.14.CB

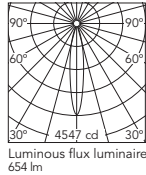

Beam Angle: 17°

h(m)	E(lx)	D(m)
1	4547	0.31
2	1137	0.61
3	505	0.92
4	284	1.23
5	182	1.53

3000K

On board dimmer

- 03.8155.40
- 03.8155.05
- 03.8155.14
- *Dali Version
- 03.8155.40.DA
- 03.8155.05.DA
- 03.8155.14.DA

*1-10V

- 03.8155.40.1V
- 03.8155.05.1V
- 03.8155.14.1V

**Casambi integrated

- 03.8155.40.CB
- 03.8155.05.CB
- 03.8155.14.CB

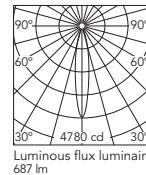

Beam Angle: 17°

h(m)	E(lx)	D(m)
1	4780	0.31
2	1195	0.61
3	531	0.92
4	299	1.23
5	191	1.53

2700K

On board dimmer

- 03.8156.40
- 03.8156.05
- 03.8156.14
- *Dali Version
- 03.8156.40.DA
- 03.8156.05.DA
- 03.8156.14.DA

*1-10V

- 03.8156.40.1V
- 03.8156.05.1V
- 03.8156.14.1V

**Casambi integrated

- 03.8156.40.CB
- 03.8156.05.CB
- 03.8156.14.CB

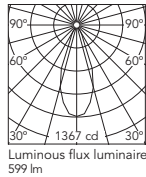

Beam Angle: 40°

h(m)	E(lx)	D(m)
1	1367	0.73
2	342	1.45
3	152	2.18
4	85	2.91
5	55	3.64

3000K

On board dimmer

- 03.8157.40
- 03.8157.05
- 03.8157.14
- *Dali Version
- 03.8157.40.DA
- 03.8157.05.DA
- 03.8157.14.DA

*1-10V

- 03.8157.40.1V
- 03.8157.05.1V
- 03.8157.14.1V

**Casambi integrated

- 03.8157.40.CB
- 03.8157.05.CB
- 03.8157.14.CB

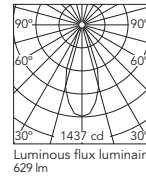

Beam Angle: 40°

h(m)	E(lx)	D(m)
1	1437	0.73
2	359	1.45
3	160	2.18
4	90	2.91
5	57	3.64

* Nur mit der Profilverision DALI, 1-10V kompatibel / Only compatible with DALI, 1-10V profile version .

** Die Steuerung bei den Casambi-Leuchten erfolgt direkt und individuell kabellos mittels der App FLOS Control® powered by Casambi / The control system with the Casambi version of light fixtures is directly and individually regulated wirelessly using the application FLOS Control® by Casambi.

INFRA-STRUCTURE – LIGHT MODULES

Spot 150

Light Source: LED Array 22,5W - 2000 lm - 2700K/CRI 90 / 22,5W - 2115 lm - 3000K/CRI 90

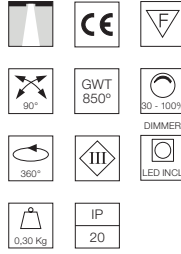
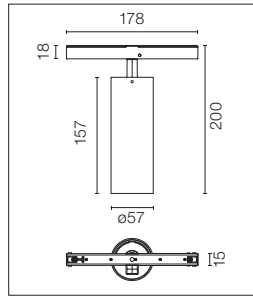

LED-Modul für Akzentbeleuchtung zur Installation in das System Infra-Structure.
Für die kabellose Steuerung der Leuchten sind die integrierten Casambi-Versionen auszuwählen.

Accent lighting LED module to be installed in The Infra-Structure System.
For wireless lighting control, choose integrated Casambi versions.

2700K

On board dimmer

- 03.8072.40
- 03.8072.05
- 03.8072.14
- *Dali Version
- 03.8072.40.DA
- 03.8072.05.DA
- 03.8072.14.DA
- *1-10V
- 03.8072.40.1V
- 03.8072.05.1V
- 03.8072.14.1V
- **Casambi integrated
- 03.8072.40.CB
- 03.8072.05.CB
- 03.8072.14.CB

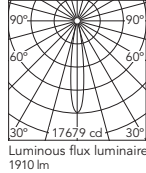

Beam Angle: 16°

h(m)	E(lx)	D(m)
1	17679	0.28
2	4420	0.56
3	1964	0.84
4	1105	1.12
5	707	1.40

Luminous flux luminaire 1910 lm

3000K

On board dimmer

- 03.8073.40
- 03.8073.05
- 03.8073.14
- *Dali Version
- 03.8073.40.DA
- 03.8073.05.DA
- 03.8073.14.DA
- *1-10V
- 03.8073.40.1V
- 03.8073.05.1V
- 03.8073.14.1V
- **Casambi integrated
- 03.8073.40.CB
- 03.8073.05.CB
- 03.8073.14.CB

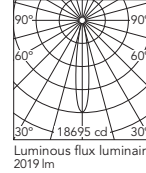

Beam Angle: 16°

h(m)	E(lx)	D(m)
1	18695	0.28
2	4674	0.56
3	2077	0.84
4	1168	1.12
5	748	1.40

Luminous flux luminaire 2019 lm

2700K

On board dimmer

- 03.8074.40
- 03.8074.05
- 03.8074.14
- *Dali Version
- 03.8074.40.DA
- 03.8074.05.DA
- 03.8074.14.DA
- *1-10V
- 03.8074.40.1V
- 03.8074.05.1V
- 03.8074.14.1V
- **Casambi integrated
- 03.8074.40.CB
- 03.8074.05.CB
- 03.8074.14.CB

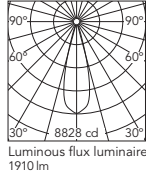

Beam Angle: 28°

h(m)	E(lx)	D(m)
1	8828	0.50
2	2207	1.00
3	981	1.50
4	552	2.00
5	353	2.50

Luminous flux luminaire 1910 lm

3000K

On board dimmer

- 03.8075.40
- 03.8075.05
- 03.8075.14
- *Dali Version
- 03.8075.40.DA
- 03.8075.05.DA
- 03.8075.14.DA
- *1-10V
- 03.8075.40.1V
- 03.8075.05.1V
- 03.8075.14.1V
- **Casambi integrated
- 03.8075.40.CB
- 03.8075.05.CB
- 03.8075.14.CB

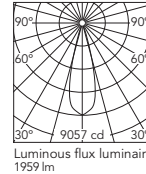

Beam Angle: 28°

h(m)	E(lx)	D(m)
1	9057	0.50
2	2264	1.00
3	1006	1.50
4	566	2.00
5	362	2.50

Luminous flux luminaire 1959 lm

2700K

On board dimmer

- 03.8076.40
- 03.8076.05
- 03.8076.14
- *Dali Version
- 03.8076.40.DA
- 03.8076.05.DA
- 03.8076.14.DA
- *1-10V
- 03.8076.40.1V
- 03.8076.05.1V
- 03.8076.14.1V
- **Casambi integrated
- 03.8076.40.CB
- 03.8076.05.CB
- 03.8076.14.CB

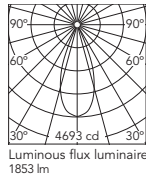

Beam Angle: 40°

h(m)	E(lx)	D(m)
1	4693	0.73
2	1173	1.46
3	521	2.18
4	293	2.91
5	188	3.64

Luminous flux luminaire 1853 lm

3000K

On board dimmer

- 03.8077.40
- 03.8077.05
- 03.8077.14
- *Dali Version
- 03.8077.40.DA
- 03.8077.05.DA
- 03.8077.14.DA
- *1-10V
- 03.8077.40.1V
- 03.8077.05.1V
- 03.8077.14.1V
- **Casambi integrated
- 03.8077.40.CB
- 03.8077.05.CB
- 03.8077.14.CB

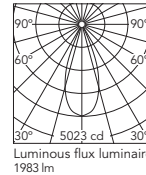

Beam Angle: 40°

h(m)	E(lx)	D(m)
1	5023	0.73
2	1256	1.46
3	558	2.18
4	314	2.91
5	201	3.64

Luminous flux luminaire 1983 lm

* Nur mit der Profiversion DALI, 1-10V kompatibel / Only compatible with DALI, 1-10V profile version.

** Die Steuerung bei den Casambi-Leuchten erfolgt direkt und individuell kabellos mittels der App FLOS Control® powered by Casambi / The control system with the Casambi version of light fixtures is directly and individually regulated wirelessly using the application FLOS Control® by Casambi.

INFRA-STRUCTURE – LIGHT MODULES

Suspension Panel 600

Light Source: Top LED 40W - 3195 lm - 2700K/CRI 90 / 40W - 3381 lm - 3000K/ CRI 90

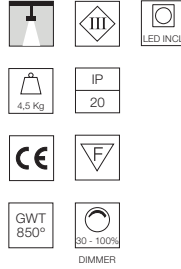
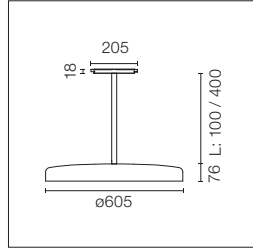

Hängeleuchte an fester Strebe zum Einbau in das Infra-Structure System.
Für die kabellose Steuerung der Leuchten sind die integrierten Casambi-Versionen auszuwählen.

Suspended luminaire with rigid rod, to be installed in the Infra-Structure system.
For wireless lighting control, choose integrated Casambi versions.

E= Außenfarbe
I= Innenfarbe

E= External Finish
I= Internal Finish

2700K

L: 100 mm

- E I On board dimmer
- 03.8140.40
- E I *Dali Version
- 03.8140.40.DA
- E I *1-10V
- 03.8140.40.1V
- E I **Casambi integrated
- 03.8140.40.CB

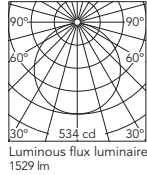

Beam Angle: 113°

h(m)	E(lx)	D(m)
1	534	3.02
2	134	6.04
3	59	9.06
4	33	12.08
5	21	15.10

Luminous flux luminaire 1529 lm

3000K

L: 100 mm

- E I On board dimmer
- 03.8142.40
- E I *Dali Version
- 03.8142.40.DA
- E I *1-10V
- 03.8142.40.1V
- E I **Casambi integrated
- 03.8142.40.CB

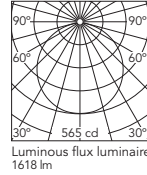

Beam Angle: 113°

h(m)	E(lx)	D(m)
1	565	3.02
2	141	6.04
3	63	9.06
4	35	12.08
5	23	15.10

Luminous flux luminaire 1618 lm

L: 400 mm

- E I On board dimmer
- 03.8141.40
- E I *Dali Version
- 03.8141.40.DA
- E I *1-10V
- 03.8141.40.1V
- E I **Casambi integrated
- 03.8141.40.CB

L: 400 mm

- E I On board dimmer
- 03.8143.40
- E I *Dali Version
- 03.8143.40.DA
- E I *1-10V
- 03.8143.40.1V
- E I **Casambi integrated
- 03.8143.40.CB

2700K

L: 100 mm

- E I On board dimmer
- 03.8140.14
- E I *Dali Version
- 03.8140.14.DA
- E I *1-10V
- 03.8140.14.1V
- E I **Casambi integrated
- 03.8140.14.CB

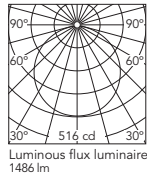

Beam Angle: 114°

h(m)	E(lx)	D(m)
1	516	3.06
2	129	6.11
3	57	9.17
4	32	12.22
5	21	15.28

Luminous flux luminaire 1486 lm

3000K

L: 100 mm

- E I On board dimmer
- 03.8142.14
- E I *Dali Version
- 03.8142.14.DA
- E I *1-10V
- 03.8142.14.1V
- E I **Casambi integrated
- 03.8142.14.CB

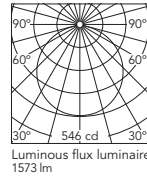

Beam Angle: 114°

h(m)	E(lx)	D(m)
1	546	3.06
2	137	6.11
3	61	9.17
4	34	12.22
5	22	15.28

Luminous flux luminaire 1573 lm

L: 400 mm

- E I On board dimmer
- 03.8141.14
- E I *Dali Version
- 03.8141.14.DA
- E I *1-10V
- 03.8141.14.1V
- E I **Casambi integrated
- 03.8141.14.CB

L: 400 mm

- E I On board dimmer
- 03.8143.14
- E I *Dali Version
- 03.8143.14.DA
- E I *1-10V
- 03.8143.14.1V
- E I **Casambi integrated
- 03.8143.14.CB

* Nur mit der Profiversion DALI, 1-10V kompatibel / Only compatible with DALI, 1-10V profile version.

** Die Steuerung bei den Casambi-Leuchten erfolgt direkt und individuell kabellos mittels der App FLOS Control® powered by Casambi / The control system with the Casambi version of light fixtures is directly and individually regulated wirelessly using the application FLOS Control® by Casambi.

INFRA-STRUCTURE – LIGHT MODULES

Suspension Glass Downlight 110

Light Source: LED Array 13,5W - 1296 lm - 2700K/CRI 90 / 13,5W - 1371 lm - 3000K/CRI 90

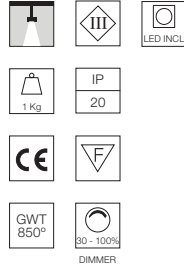
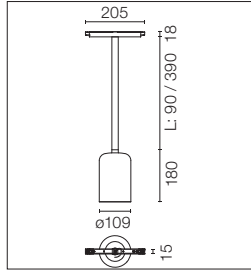

Hängeleuchte an fester Strebe aus geblasenem Glas in verschiedenen Farben zum Einbau in das Infra-Structure System.
Für die kabellose Steuerung der Leuchten sind die integrierten Casambi-Versionen auszuwählen.

Suspended luminaire with rigid rod and blown glass in several finishes to be installed in the Infra-Structure system.
For wireless lighting control, choose integrated Casambi versions.

2700K

Black Rod
L: 100 mm

On board dimmer

- 03.8130.00
- 03.8130.FU
- 03.8130.RC

*Dali Version

- 03.8130.00.DA
- 03.8130.FU.DA
- 03.8130.RC.DA

*1-10V

- 03.8130.00.1V
- 03.8130.FU.1V
- 03.8130.RC.1V

**Casambi integrated

- 03.8130.00.CB
- 03.8130.FU.CB
- 03.8130.RC.CB

Black Rod
L: 400 mm

On board dimmer

- 03.8131.00
- 03.8131.FU
- 03.8131.RC

*Dali Version

- 03.8131.00.DA
- 03.8131.FU.DA
- 03.8131.RC.DA

*1-10V

- 03.8131.00.1V
- 03.8131.FU.1V
- 03.8131.RC.1V

**Casambi integrated

- 03.8131.00.CB
- 03.8131.FU.CB
- 03.8131.RC.CB

White Rod
L: 100 mm

On board dimmer

- 03.8135.00
- 03.8135.FU
- 03.8135.RC

*Dali Version

- 03.8135.00.DA
- 03.8135.FU.DA
- 03.8135.RC.DA

*1-10V

- 03.8135.00.1V
- 03.8135.FU.1V
- 03.8135.RC.1V

**Casambi integrated

- 03.8135.00.CB
- 03.8135.FU.CB
- 03.8135.RC.CB

3000K

Black Rod
L: 100 mm

On board dimmer

- 03.8132.00
- 03.8132.FU
- 03.8132.RC

*Dali Version

- 03.8132.00.DA
- 03.8132.FU.DA
- 03.8132.RC.DA

*1-10V

- 03.8132.00.1V
- 03.8132.FU.1V
- 03.8132.RC.1V

**Casambi integrated

- 03.8132.00.CB
- 03.8132.FU.CB
- 03.8132.RC.CB

Black Rod
L: 400 mm

On board dimmer

- 03.8133.00
- 03.8133.FU
- 03.8133.RC

*Dali Version

- 03.8133.00.DA
- 03.8133.FU.DA
- 03.8133.RC.DA

*1-10V

- 03.8133.00.1V
- 03.8133.FU.1V
- 03.8133.RC.1V

**Casambi integrated

- 03.8133.00.CB
- 03.8133.FU.CB
- 03.8133.RC.CB

White Rod
L: 100 mm

On board dimmer

- 03.8137.00
- 03.8137.FU
- 03.8137.RC

*Dali Version

- 03.8137.00.DA
- 03.8137.FU.DA
- 03.8137.RC.DA

*1-10V

- 03.8137.00.1V
- 03.8137.FU.1V
- 03.8137.RC.1V

**Casambi integrated

- 03.8137.00.CB
- 03.8137.FU.CB
- 03.8137.RC.CB

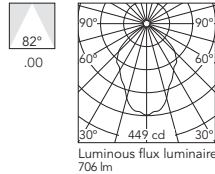

Beam Angle: 82°

h(m)	E lx	D(m)
1	449	1.74
2	112	3.48
3	50	5.22
4	28	6.96
5	18	8.71

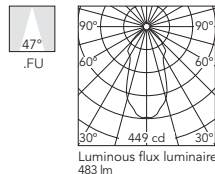

Beam Angle: 47°

h(m)	E lx	D(m)
1	449	0.86
2	112	1.72
3	50	2.58
4	28	3.45
5	18	4.31

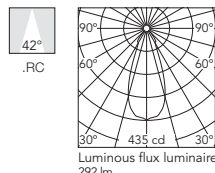

Beam Angle: 42°

h(m)	E lx	D(m)
1	435	0.76
2	109	1.52
3	48	2.28
4	27	3.04
5	17	3.80

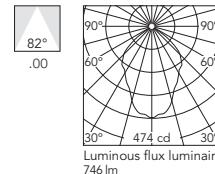

Beam Angle: 82°

h(m)	E lx	D(m)
1	474	1.74
2	119	3.48
3	53	5.22
4	30	6.96
5	19	8.71

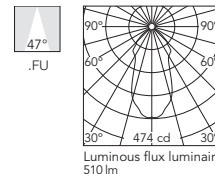

Beam Angle: 47°

h(m)	E lx	D(m)
1	474	0.86
2	119	1.72
3	53	2.58
4	30	3.45
5	19	4.31

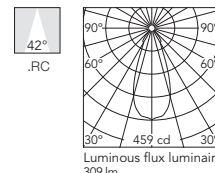

Beam Angle: 42°

h(m)	E lx	D(m)
1	459	0.76
2	115	1.52
3	51	2.28
4	29	3.04
5	18	3.80

00 Transparentes Glas
00 Transparent Glass

FU Rauchglas
FU Smoked Glass

RC Rotes Glas
RC Red Glass

* Nur mit der Profilverision DALI, 1-10V kompatibel / Only compatible with DALI, 1-10V profile version.

** Die Steuerung bei den Casambi-Leuchten erfolgt direkt und individuell kabellos mittels der App FLOS Control® powered by Casambi / The control system with the Casambi version of light fixtures is directly and individually regulated wirelessly using the application FLOS Control® by Casambi.

- White Rod
L: 400 mm
On board dimmer
- 03.8136.00
 - 03.8136.FU
 - 03.8136.RC
 - *Dali Version
 - 03.8136.00.DA
 - 03.8136.FU.DA
 - 03.8136.RC.DA
 - *1-10V
 - 03.8136.00.1V
 - 03.8136.FU.1V
 - 03.8136.RC.1V
 - **Casambi integrated
 - 03.8136.00.CB
 - 03.8136.FU.CB
 - 03.8136.RC.CB







- White Rod
L: 400 mm
On board dimmer
- 03.8138.00
 - 03.8138.FU
 - 03.8138.RC
 - *Dali Version
 - 03.8138.00.DA
 - 03.8138.FU.DA
 - 03.8138.RC.DA
 - *1-10V
 - 03.8138.00.1V
 - 03.8138.FU.1V
 - 03.8138.RC.1V
 - **Casambi integrated
 - 03.8138.00.CB
 - 03.8138.FU.CB
 - 03.8138.RC.CB

Zubehör / Accessories







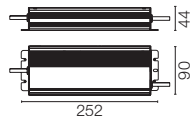

Spot 150

Querabschirmung, Linsen und Honeycomb können ohne Befestigungszubehör direkt in den Leuchtenkopf eingesetzt werden. Honeycomb + Linse können gleichzeitig verwendet werden.

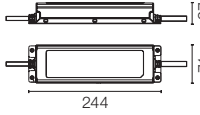
Screening crosspiece, lenses and honeycomb directly installable on the head of the luminaire without needing any fastening accessory. Installation compatible with honeycomb + lense at the same time.

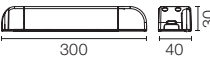
Querabschirmung.	Screening crosspiece.		08.8429.00
Elliptische linse.	Elliptical lens.		08.8431.00
Floodlinse.	Flood lens.		08.8432.00
Honeycomb.	Honeycomb.		08.8428.00
Konische abschirmung.	Snoot shielding cone.		 08.0526.00 08.0526.40 08.0526.BW

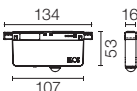
Treiber / Drivers

LED-Netzteil für Ferninstallation 48V/320W. 100/240 Vac.	LED power supply source for remote installation, 48V/320W. 100/240 Vac.			***60.8919
LED-Netzteil für Ferninstallation 110Vac-135W / 220Vac-200W.	LED power supply source for remote installation, 110Vac-135W / 220Vac-200W.			***60.9607
LED-Netzteil für Ferninstallation 48V/120W. 220/240 Vac.	LED power supply source for remote installation, 48V/120W. 220/240 Vac.			***60.9170
Dimmbarer Steuerkasten 1-10V, 48V. Für Ferninstallation. Notwendig, um passive 1-10V Steuerungssysteme in aktive zu verwandeln.	Dimmable control box 1-10V, 48V. For remote installation. Necessary to transform passive 1-10V control systems into active ones.			08.0613.14A
Multifunktionales Smart Device. Dreifachfunktionalität 3x1: Casambi Signalverstärker, Lichtsensor und Präsenzmelder. FLOS Control® by Casambi.	Multifunction Smart Device. Triple functionality 3x1: Casambi signal repeater, light sensor and presence detector. FLOS Control® by Casambi.			 06.1988.40 06.1988.14

*** Bei der Dimensionierung der Anlage ist eine Sicherheitsspanne von 15% der maximalen Leistung der LED-Stromversorgung einzuhalten / For the sizing of the installation keep a safety margin of 15% of the maximum power of the LED power source.

INFRA-STRUCTURE Episode 2

DESIGNED BY VINCENT VAN DUYSSEN

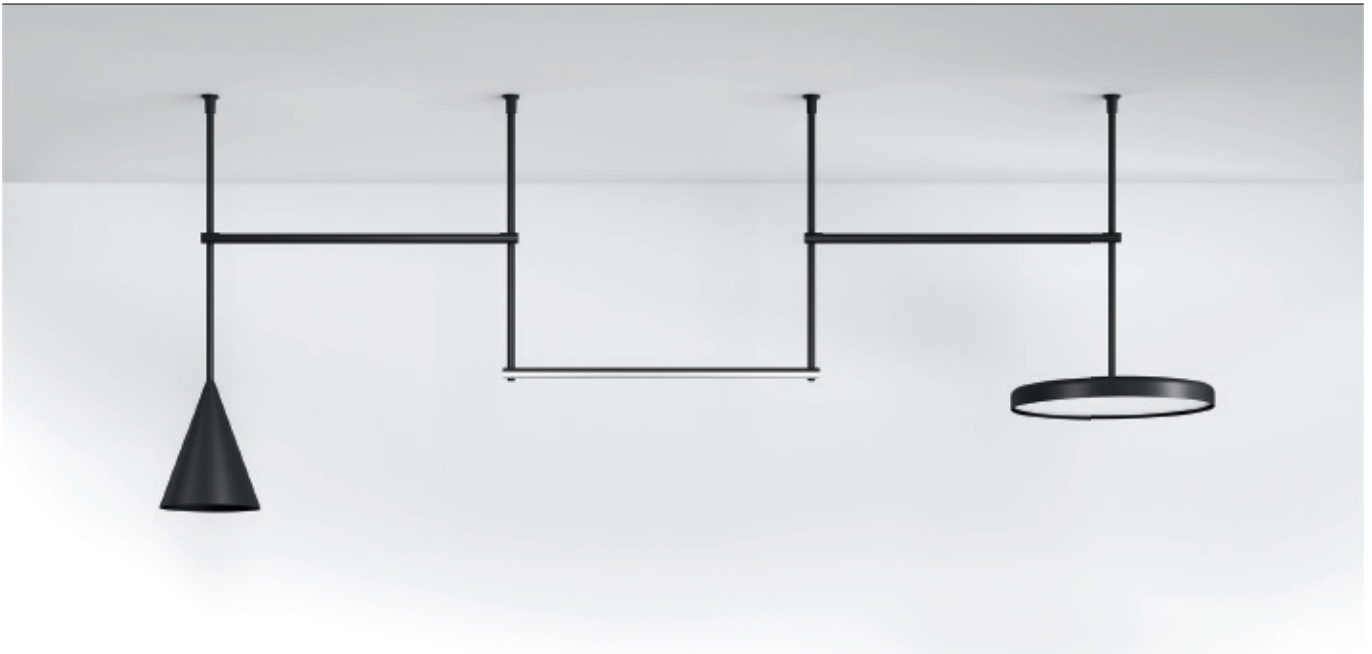

Profiles 40 Weiss
40 White 14 Schwarz
14 Black

LIGHT MODULES

LIGHT TUBE DIRECT-INDIRECT



LIGHT SOURCE
TOP LED
24W/m
1978 lm/m
2700K/CRI 90
2227 lm/m
3000K/CRI 90

SUSPENSION CONE 300



LIGHT SOURCE
TOP LED
30W
2800 lm
2700K/CRI 90
3000 lm
3000K/CRI 90

SUSPENSION CONE 400



LIGHT SOURCE
TOP LED
41W
3750 lm
2700K/CRI 90
4000 lm
3000K/CRI 90

SUSPENSION PANEL 600



LIGHT SOURCE
TOP LED
35,5W
3195 lm
2700K/CRI 90
3381 lm
3000K/CRI 90

LIGHT TUBE COVERED



LIGHT SOURCE
TOP LED
24W/m
1978 lm/m
2700K/CRI 90
2227 lm/m
3000K/CRI 90

Produktbeschreibung

Die Neuinterpretation einer Ikone: Das einzigartige Design von Infra-Structure entwickelt sich dank einer neuen, extrem vereinfachten modularen Bauweise weiter. Die minimalistischen, jedoch visuell beeindruckenden Elemente können kombiniert werden, um jeden architektonischen Raum mit einer starken Bühnenpräsenz zu kennzeichnen.

Einfache, unglaublich vielseitige Rohrstruktur. Dank eines besonderen Anschlussystems ist es möglich, vertikale und horizontale Elemente zu kombinieren, um dreidimensionale Kombinationen mit unbegrenzten Variationen mit linearen und geometrischen Modulen zu schaffen.

Die mechanische Verbindung zwischen den einzelnen Modulen, aus denen die Struktur besteht, erfolgt mittels Schrauben, die eine schnelle und sichere Installation gewährleisten. Jedes Modul wird mithilfe zwei kleinen, nahezu unsichtbaren Gewindestiftes eingerastet, sobald die Installation abgeschlossen ist.

Die elektrischen Verbindungen der Beleuchtungsmodule sind extrem einfach vorzunehmen. Jedes Leuchtelement wird mit einem 4 meter langen Stromkabel mit einer Mikro-Ausgangsbuchse vervollständigt. Das Kabel verläuft durch all die verschiedenen Abschnitte der vertikalen Struktur und wird dort an das zentrale Netz in der Decke angeschlossen.

Die Strukturelemente werden rohrförmig aus extrudiertem Aluminium in schwarzer oder weißer Farbe hergestellt und mit 48 V versorgt.

Systemgesteuert (DALI, 1-10V, FLOS Control®) durch Fernspeisung mit Broadcast-Steuerung (alle zusammen) oder separater Steuerung mit einem Treiber für jedes Lichtmodul.

Die Produktgruppe der Leuchten besteht aus allgemeinen Beleuchtungseinheiten in unterschiedlicher Optik und Umgebungsbeleuchtungsanlagen mit direktem und indirektem Licht.

Konfiguration

Die extreme Schlichtheit der Elemente und die Geschwindigkeit, mit der diese kombiniert werden können, erlauben es, der Kreativität des Projekts freien Lauf zu lassen und unzählige Kombinationen zu erzielen. Wie in einem dreidimensionalen Netz ist es ausreichend, die vertikalen Achsen der Struktur zu definieren und diese dann visuell (und elektrisch) mit Lichtmodulen, die frei im 360°-Winkel rotieren können, zu verbinden, um eine unglaubliche Flexibilität der Installation zu gewährleisten.

Steuerung

- Die Leuchten sind mit den Systemen DALI, 1-10V und Casambi kompatibel.
- Für die 1-10V Regelung muss das Steuerungssystem aktiv und der Datenbus direkt an die Steuerung angeschlossen sein. Falls eine individuelle Steuerung gewünscht ist, ist ein dimmbarer Treiber für jede Beleuchtungseinheit oder Gruppe erforderlich.
- Für die Steuerung des Casambi-Systems muss eine Casambi-Schnittstelle bestellt werden und mit einem DALI- oder 1-10V-Treiber verbunden werden. Für Mobilgeräte ist die App FLOS Control® powered by Casambi erforderlich (erhältlich im Apple Store und auf Google Play).

Optisches System

- Light Tube Direct / Light Tube Indirect / Light Tube Covered / Suspension Panel 600: Direkte Allgemeinbeleuchtung.
- Light Tube Indirect: Indirekte Allgemeinbeleuchtung.
- Suspension Cone 300 / Suspension Cone 400: Direkte Allgemeinbeleuchtung Flood.

Einspeisung

Fern-Netzteil 48V nicht enthalten.

Zusatzinformationen

Schutzgrad IP20.

Auf normal entflammaren Oberflächen einsetzbar.

Qualitätszeichen

Das Gerät entspricht der europäischen technischen Norm EN60598-1 und den entsprechenden Zusatzregelungen.

Description

The reinterpretation of an icon: the unique design of Infra-Structure evolves thanks to a new, extremely simplified modular concept.

The subtle but visually stunning elements can be combined to characterize any architectural space with a strong stage presence. Subtle, incredibly versatile tubular structure. Thanks to a special connection system, it is possible to combine vertical and horizontal elements to create three-dimensional combinations in infinite variations using linear and geometric modules.

The mechanical connection between the individual modules that make up the structure is made through a screw system that guarantees a fast and safe installation. Each module is locked in place by integrating two small, almost invisible grub screws once the installation is complete.

The electrical connections of the lighting modules are extremely simple to make. Each lighting element is completed by a long 4 m electrical cable equipped with an output micro connector. The cable runs through all the different sections of the vertical structure and is then connected to the grid in the ceiling.

All structural components are made of extruded aluminium tubular profiles painted black or white with 48V feeding.

The system can be controlled as a group (DALI, 1-10V, FLOS Control®) through remote power supply units with broadcast control or individual control by means of one single driver for each lighting module.

The family is made of lighting modules for general lighting featuring different optics and linear lighting modules providing diffused direct or indirect emission.

Configuration

The extreme simplicity of the elements and the speed with which they can be combined allows to free up the creativity of the project and to achieve innumerable combinations. As in a three-dimensional network, simply define the vertical axes of the structure and then connect them visually (and electrically) with lighting modules that can freely rotate 360°. An incredible installation flexibility is guaranteed.

Control

- Lighting modules are compatible with DALI, 1-10V and Casambi.
- For 1-10V management, the control system must be active, and the data bus must be connected directly to the controller. In case of individual control one dimmable driver for each lighting unit or group is required.
- To manage the Casambi system a Casambi interface module must be ordered and connected to a DALI or 1-10V driver. To manage the system it is necessary to download the FLOS Control® powered by Casambi app (available on Apple Store and Google Play).

Optic system

- Light Tube Direct / Light Tube Indirect / Light Tube Covered / Suspension Panel 600: diffused lighting direct.
- Light Tube Indirect: diffused lighting indirect.
- Suspension Cone 300 / Suspension Cone 400: direct Flood lighting.

Power Supply

Remote 48V power supply not included.

Additional Information

IP20 protection grade.

Suitable for installation on normally inflammable surfaces.

Compliance of Standards and Quality Marks

EN60598-1 European Technical Standards and any subsequent additions.

FLOS
CONTROL BY CASAMBI



INFRA-STRUCTURE Episode 2 – PROFILES

SURFACE INSTALLATION

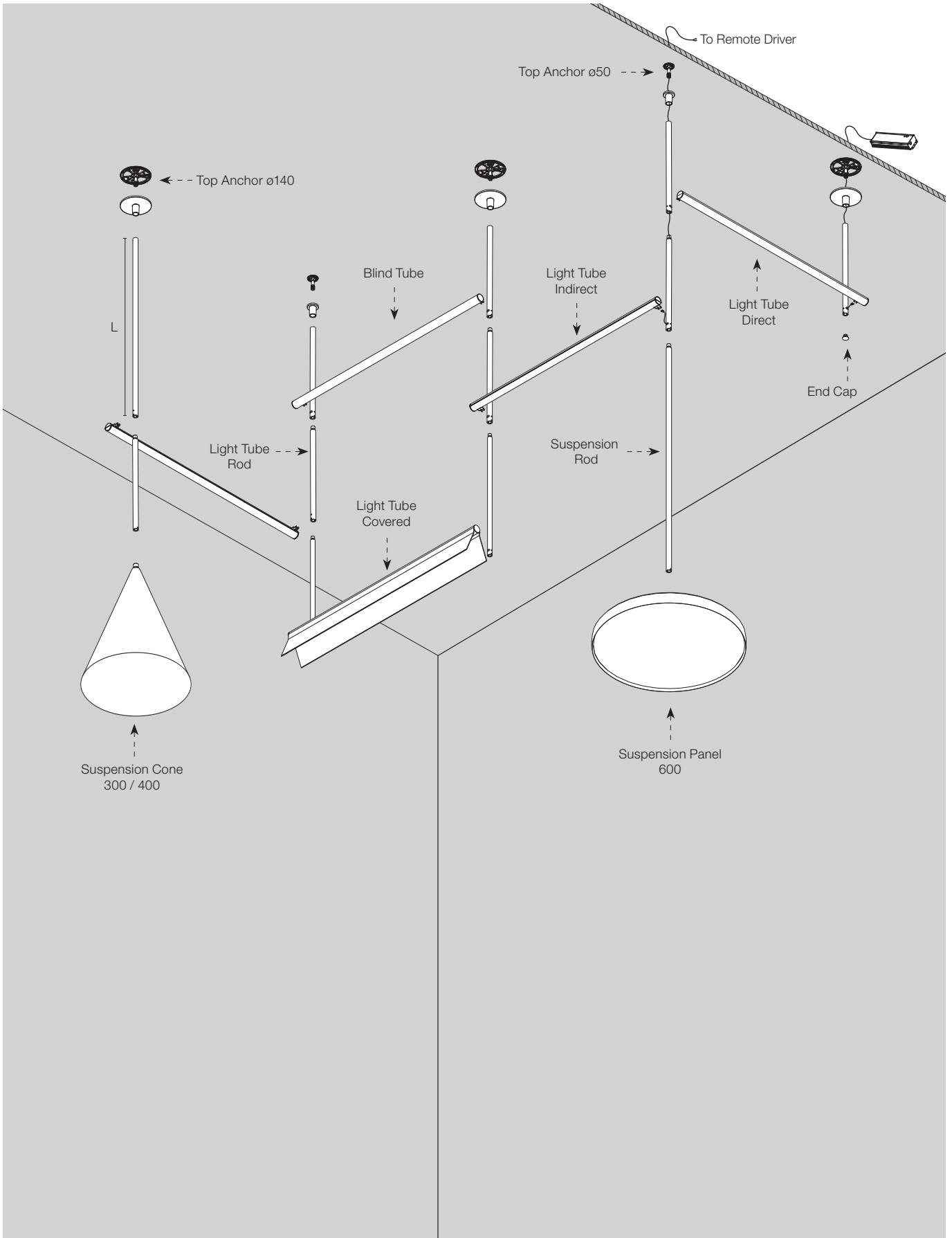

INFRA-STRUCTURE Episode 2 – PROFILES

Top-Anker ø140.

Für Installationen, bei denen die Stromversorgungseinheit hinter der Zwischendecke versteckt werden muss und kein Zugriff von einer anderen Stelle möglich ist. Die 140 mm große Blende verdeckt das notwendige Loch für die Einheit.

Top Anchor ø140.

For installation where the power supply is to be hidden within a drop ceiling and there is no other access. The 140-mm cover conceals the hole needed to install the device.

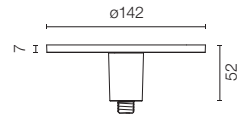

06.5421.40
06.5421.14

Top-Anker ø50.

Für Installationen, bei denen die Stromversorgungseinheit entfernt in der Installationsbox installiert werden muss oder ein Zugriff von einer anderen Stelle möglich ist. Die 50 mm große Blende verdeckt das Kabel und verhindert den Zugriff auf die Stromversorgungseinheit.

Top Anchor ø50.

For installations where the power supply equipment must be installed remotely in an installation box or there is access to it from another point. The 50-mm cover conceals the cable and prevents access to the power supply.

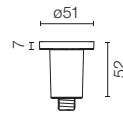

06.5420.40
06.5420.14

Endkappe.

End cap.



06.5430.40
06.5430.14

Stange.

Stangen in verschiedenen Größen für den Anschluss von direkten und indirekten linearen Lichtmodulen. Es ist möglich, mehrere Elemente gleichzeitig mittels Befestigungselementen und integrierter mechanischer Sicherheitsverriegelung zu verbinden. Stromkabel für drei Leuchten können durch jede vertikale Stange geführt werden.

Rod.

Rod available in different lengths for connection of direct and indirect linear light tubes. Various elements may be connected simultaneously by means of attachment elements along with a mechanically integrated safety device. Power cables for three luminaires may be fed through each vertical rod.

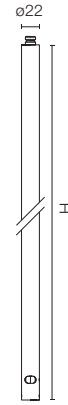

H: 100 mm
06.5400.40
06.5400.14
H: 200 mm
06.5401.40
06.5401.14
H: 400 mm
06.5402.40
06.5402.14
H: 600 mm
06.5403.40
06.5403.14
H: 800 mm
06.5404.40
06.5404.14
H: 1000 mm
06.5405.40
06.5405.14

Aufhängung Stange.

Stangen in verschiedenen Größen für den Anschluss der Module "Suspension Panel" und "Suspension Cone" und für Erweiterungen ohne Verbindung zur Leuchte. Stromkabel für drei Leuchten können durch jede vertikale Stange geführt werden.

Suspension Rod.

Rod available in different lengths for connection of "Suspension Panel" and "Suspension Cone" modules and for extensions without connection to a light fixture. Power cables for three luminaires may be fed through each vertical rod.

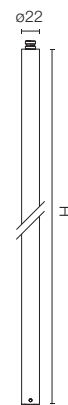

H: 100 mm
06.5410.40
06.5410.14
H: 200 mm
06.5411.40
06.5411.14
H: 400 mm
06.5412.40
06.5412.14
H: 600 mm
06.5413.40
06.5413.14
H: 800 mm
06.5414.40
06.5414.14
H: 1000 mm
06.5415.40
06.5415.14

Blindrohr.

Mechanisches Modul (ohne Beleuchtung) zum installieren in dem System Infra-Struktur Episode 2.

Blind tube.

A mechanical module (without lighting) to be installed in the system infrastructure Episode 2.

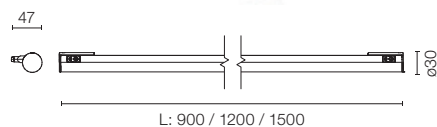

L: 900 mm
03.8430.40
03.8430.14
L: 1200 mm
03.8431.40
03.8431.14
L: 1500 mm
03.8432.40
03.8432.14

INFRA-STRUCTURE Episode 2 – FAQ

- **Ist Infra-Structure Episode 2 ein System auf Schienen wie Infra-Structure?**

Nein. Infra-Structure Episode 2 ist ein modulares System, hat jedoch keine Schienen.

- **Wie werden die vertikalen Stangen miteinander verbunden?**

Die einzelnen Module der vertikalen Struktur werden mit einem Schraubensystem verbunden, das eine schnelle und sichere Installation gewährleistet. Jedes Modul wird mit Hilfe einer kleinen Stellschrauben arretiert, die nach Abschluss der Installation praktisch unsichtbar ist.

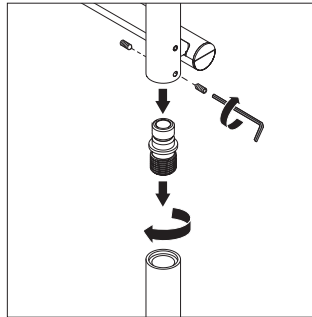

- **Is Infra-Structure Episode 2 a system on tracks like Infra-Structure?**

No. Infra-Structure Episode 2 is a modular system, but it doesn't have tracks.

- **How are the vertical rods connected together?**

The individual modules composing the vertical structure are connected using a system of screws that guarantee quick, safe installation. Each module is fixed in place with the help of small set screws that is practically invisible once installation is complete.

- **Sind nichtlineare Zusammensetzungen möglich?**

Ja. Maximale Flexibilität wird durch die mechanische Verbindung zwischen den vertikalen Stangen gewährleistet, die auf den gewünschten Winkel eingestellt werden können.

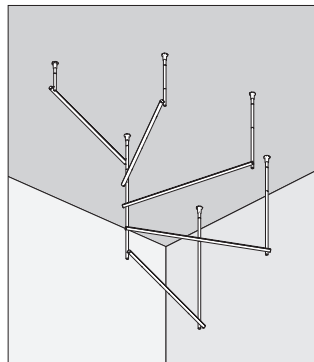

- **Is it possible to obtain non-linear compositions?**

Yes. Maximum flexibility is provided for with the mechanical connection between the vertical rods, which can be adjusted to the desired angle.

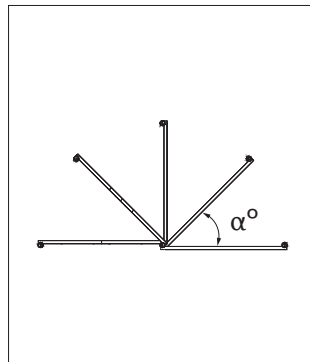

- **Wie viele Leuchten kann ich mit derselben vertikalen Stange versorgen?**

Stromkabel für drei Leuchten können durch jede vertikale Stange geführt werden.

- **How many luminaires can I power using the same vertical rod?**

Power cables for three luminaires may be fed through each vertical rod.

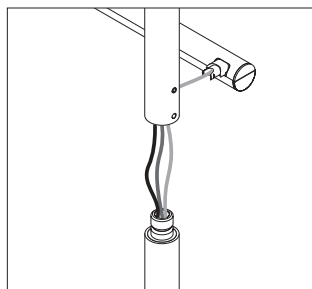

- **Kann das Licht der Leuchten gedämpft werden?**

Ja. Mit dem im Geräteabschnitt aufgeführten Steuermodul kann die Lichtmenge über DALI, 1-10 V und Casambi geregelt werden.

- **Can the light from the luminaires be dimmed?**

Yes. With the control module listed in the equipment section, the amount of light can be regulated via DALI, 1-10V and Casambi.

- **Was ist die maximale Aufhängungslänge?**

Die mit der Lampe gelieferten Kabel haben eine maximale Länge von 4 Metern.

- **What is the maximum suspension length?**

The cables supplied with the lamp have a maximum length of 4 metres.

- **Kann das Produkt mit dem in der abgehängten Decke versteckten Netzteil installiert werden?**

Das System kann nur mit einem versteckten Netzteil installiert werden. Es ist mit einer 140-mm-Rosette ausgestattet, damit der Strom durchfließen kann und das Loch verdeckt wird.

- **Can it be installed with the power supply hidden in the drop ceiling?**

The system can only be installed with a hidden power supply. It is equipped with a 140-mm rose for the power to pass through and to hide the hole.

INFRA-STRUCTURE Episode 2 – LIGHT MODULES

Light Tube Direct

Light Source: Top LED 24W/m - 1978 lm/m - 2700K/CRI 90 / 24W/m - 2227 lm/m - 3000K/CRI 90

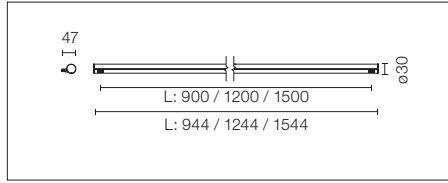

LED-Beleuchtungsmodul mit diffusem Licht für die Installation in Infra-Structure Episode 2. Befestigungselemente und mechanische Sicherheitsverriegelung für die transversale Installation zwischen zwei Stangen. Die Light Tubes werden nur an einem der Enden mit Strom versorgt und leiten keinen Strom über das andere Ende. Jedes Leuchtelement wird mit einem 4 meter langen Stromkabel mit einer Mikro-Ausgangsbuchse vervollständigt.

Diffused LED light module to be installed in the Infra-Structure Episode 2. Safety fixing and locking mechanical elements integrated for a transversal installation between two rods of the profile. The Light Tubes are only fed by one of the ends and do not communicate current through the other end. Each lighting element is completed by a long 4m electrical cable equipped with an output microconnector.

2700K
L: 900 mm - 22W - 1820 lm
03.8400.40
03.8400.14

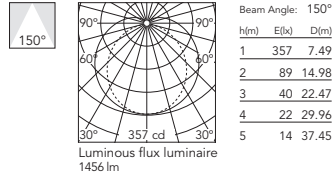

3000K
L: 900 mm - 22W - 2048 lm
03.8403.40
03.8403.14

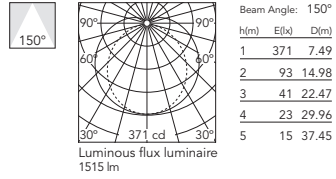

2700K
L: 1200 mm - 29W - 2366 lm
03.8401.40
03.8401.14

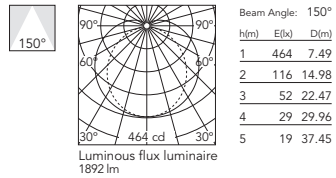

3000K
L: 1200 mm - 29W - 2663 lm
03.8404.40
03.8404.14

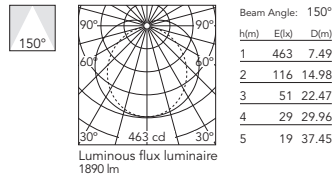

2700K
L: 1500 mm - 35,5W - 2912 lm
03.8402.40
03.8402.14

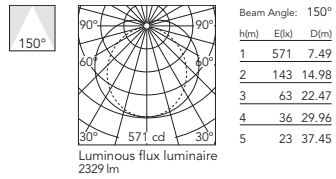

3000K
L: 1500 mm - 35,5W - 3278 lm
03.8405.40
03.8405.14

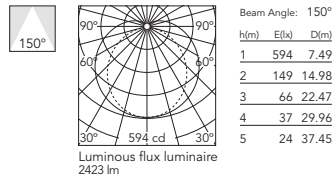

INFRA-STRUCTURE Episode 2 – LIGHT MODULES

Light Tube Indirect

Light Source: Top LED 24W/m - 1978 lm/m - 2700K/CRI 90 / 24W/m - 2227 lm/m - 3000K/CRI 90

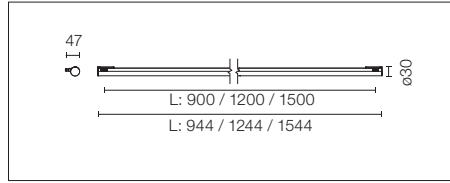

LED-Beleuchtungsmodul mit indirektem diffusem Licht für die Installation in Infra-Structure Episode 2. Befestigungselemente und mechanische Sicherheitsverriegelung für die transversale Installation zwischen zwei Stangen. Die Light Tubes werden nur an einem der Enden mit Strom versorgt und leiten keinen Strom über das andere Ende. Jedes Leuchtelement wird mit einem 4 meter langen Stromkabel mit einer Mikro-Ausgangsbuchse vervollständigt.

Diffused indirect LED light module to be installed in the Infra-Structure Episode 2. Safety fixing and locking mechanical elements integrated for a transversal installation between two rods of the profile. The Light Tubes are only fed by one of the ends and do not communicate current through the other end. Each lighting element is completed by a long 4m electrical cable equipped with an output microconnector.

2700K
L: 900 mm - 20W - 1820 lm
03.8410.40
03.8410.14

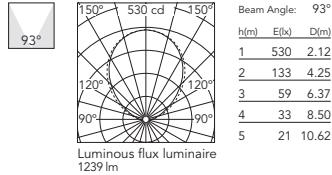

3000K
L: 900 mm - 20W - 2048 lm
03.8413.40
03.8413.14

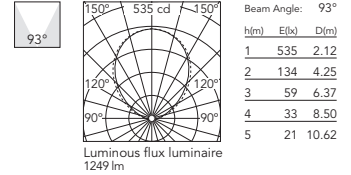

2700K
L: 1200 mm - 25,5W - 2366 lm
03.8411.40
03.8411.14

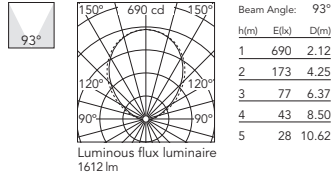

3000K
L: 1200 mm - 25,5W - 2663 lm
03.8414.40
03.8414.14

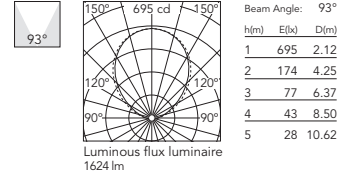

2700K
L: 1500 mm - 32,5W - 2912 lm
03.8412.40
03.8412.14

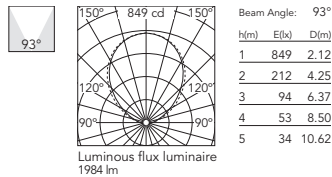

3000K
L: 1500 mm - 32,5W - 3278 lm
03.8415.40
03.8415.14

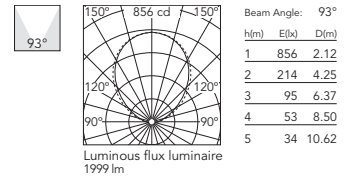

Suspension Cone 300

Light Source: Top LED 30W - 2800 lm - 2700K/CRI 90 / 30W - 3000 lm - 3000K/CRI 90

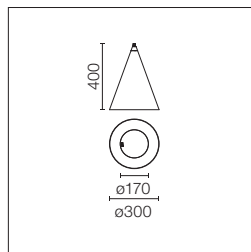

Pendelleuchte mit integriertem Befestigungssystem für die Installation in Infra-Structure Episode 2. Jedes Leuchtelement wird mit einem 4 meter langen Stromkabel mit einer Mikro-Ausgangsbuchse vervollständigt.

Suspended luminaire with locking system integrated, to be installed in the Infra-Structure Episode 2 system. Each lighting element is completed by a long 4m electrical cable equipped with an output microconnector.

2700K
03.8440.40
03.8440.14

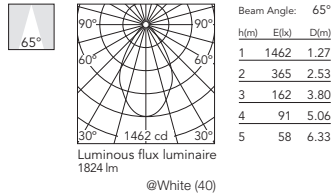

3000K
03.8442.40
03.8442.14

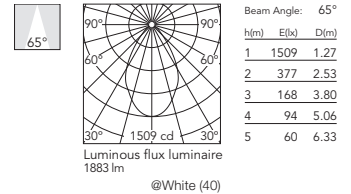

INFRA-STRUCTURE Episode 2 – LIGHT MODULES

Suspension Cone 400

Light Source: Top LED 41W - 3750 lm - 2700K/CRI 90 / 41W - 4000 lm - 3000K/CRI 90

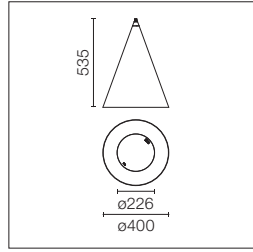

Pendelleuchte mit integriertem Befestigungssystem für die Installation in Infra-Structure Episode 2. Jedes Leuchtelement wird mit einem 4 meter langen Stromkabel mit einer Mikro-Ausgangsbuchse vervollständigt.

Suspended luminaire with locking system integrated, to be installed in the Infra-Structure Episode 2 system. Each lighting element is completed by a long 4m electrical cable equipped with an output microconnector.

2700K
 03.8441.40
 03.8441.14

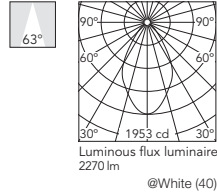

3000K
 03.8443.40
 03.8443.14

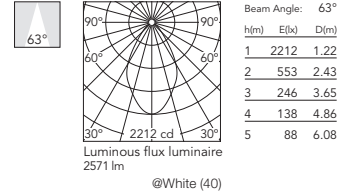

Suspension Panel 600

Light Source: Power LED 35,5W - 3195 lm - 2700K/CRI 90 / 35,5W - 3381 lm - 3000K/CRI 90

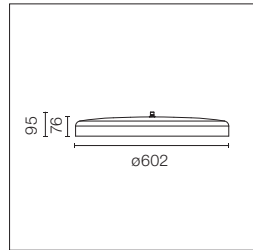

Pendelleuchte mit integriertem Befestigungssystem für die Installation in Infra-Structure Episode 2. Jedes Leuchtelement wird mit einem 4 meter langen Stromkabel mit einer Mikro-Ausgangsbuchse vervollständigt.

Suspended luminaire with locking system integrated, to be installed in the Infra-Structure Episode 2 system. Each lighting element is completed by a long 4m electrical cable equipped with an output microconnector.

2700K
 03.8450.40
 03.8450.14

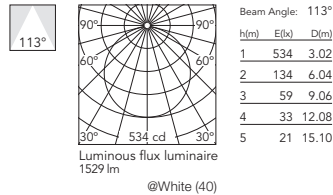

3000K
 03.8451.40
 03.8451.14

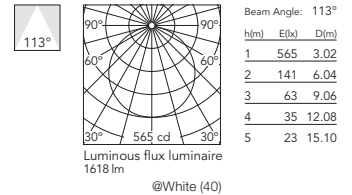

INFRA-STRUCTURE Episode 2 – LIGHT MODULES

Light Tube Covered

Light Source: Top LED 24W/m - 1978 lm/m - 2700K/CRI 90 / 24W/m - 2227 lm/m - 3000K/CRI 90

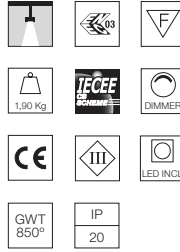
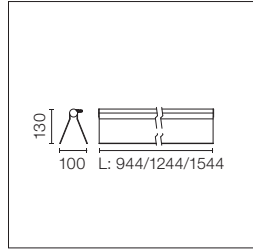

LED-Beleuchtungsmodul mit direktem und abgeschirmtm diffusum Licht für die Installation in Infra-Structure Episode 2. Befestigungselemente und mechanische Sicherheitsverriegelung für die transversale Installation zwischen zwei Stangen. Die Light Tubes werden nur an einem der Enden mit Strom versorgt und leiten keinen Strom über das andere Ende. Jedes Leuchtelement wird mit einem 4 meter langen Stromkabel mit einer Mikro-Ausgangsbuchse vervollständigt.

Diffused direct shielded LED light module to be installed in the Infra-Structure Episode 2. Safety fixing and locking mechanical elements integrated for a transversal installation between two rods of the profile. The Light Tubes are only fed by one of the ends and do not communicate current through the other end. Each lighting element is completed by a long 4m electrical cable equipped with an output microconnector.

2700K
L: 900 mm - 22W - 1820 lm
03.8420.40
03.8420.14

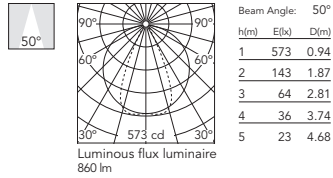

3000K
L: 900 mm - 22W - 2048 lm
03.8423.40
03.8423.14

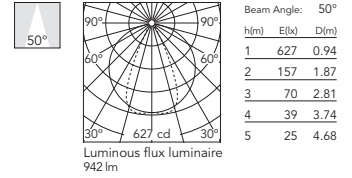

2700K
L: 1200 mm - 29W - 2366 lm
03.8421.40
03.8421.14

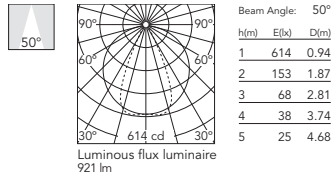

3000K
L: 1200 mm - 29W - 2663 lm
03.8424.40
03.8424.14

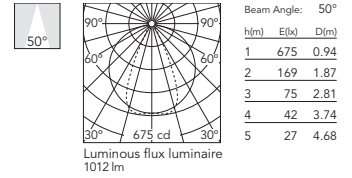

2700K
L: 1500 mm - 35,5W - 2912 lm
03.8422.40
03.8422.14

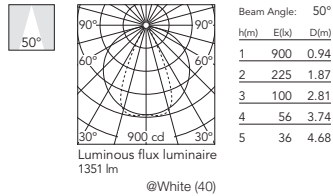

3000K
L: 1500 mm - 35,5W - 3278 lm
03.8425.40
03.8425.14

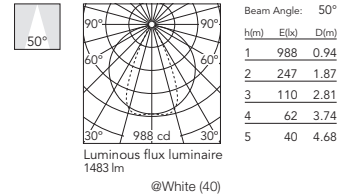

INFRA-STRUCTURE Episode 2

Treiber / Drivers

LED-Netzteil für Ferninstallation
48V/320W. 100/240 Vac.

LED power supply source for
remote installation, 48V/320W.
100/240 Vac.

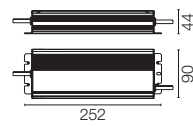

*60.8919

LED-Netzteil für Ferninstallation
110Vac-135W / 220Vac-200W.

LED power supply source for
remote installation,
110Vac-135W / 220Vac-200W.

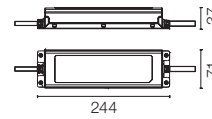

*60.9607

LED-Netzteil für Ferninstallation
48V/120W. 220/240 Vac.

LED power supply source for
remote installation, 48V/120W.
220/240 Vac.

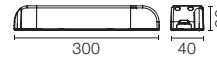

*60.9170

Casambi Broadcast

Kontroller Casambi 220-240V.
Benötigt Einspeisung und
Regler, separat bestellen.
Dimmbereich 20-100 %.

Casambi controller 220-240V.
Driver and external interface
required have to be ordered
separately.
Dimming range 20-100%.

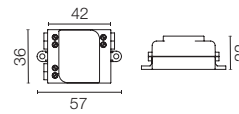

60.9392

DALI Push 48V PWM-Treiber für
indirekte Lichtsteuerung (UP).

DALI Push 48V PWM Uplight
dimmer for controlling indirect
lighting (UP).

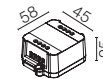

60.9678

Triebler 1-10V Push 48V PWM für
indirekte Lichtsteuerung (UP).

1-10V Push 48V PWM Uplight
dimmer for controlling indirect
lighting (UP).

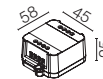

60.9395

Regulation Systems

0/1-10V / DALI Installation

0/1-10V / DALI
CONTROL SIGNAL

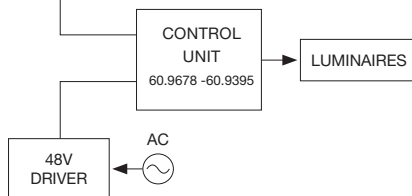

CASAMBI Installation

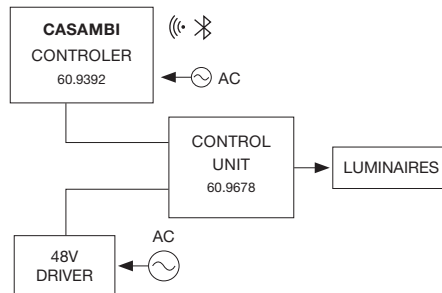

PUSH Installation

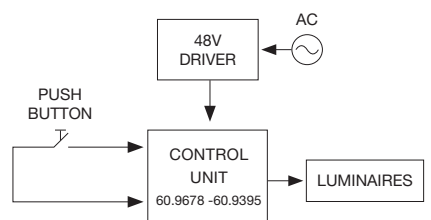

* Bei der Dimensionierung der Anlage ist eine Sicherheitsspanne von 15 % der maximalen Leistung der LED-Stromversorgung einzuhalten / For the sizing of the installation keep a safety margin of 15% of the maximum power of the LED power source.

** Es benötigt eine Installationsbox. Kompatible DALI-Schnittstelle (IEC 62386-101/102) zur Steuerung der indirekten Beleuchtung. Da es sich um eine kompatible DALI-Komponente handelt, beachten Sie bitte, dass diese nicht auf erweiterte Funktionen des DALI-Protokolls reagieren kann. Weitere Informationen erhalten Sie im Abschnitt der technischen Spezifikationen auf der Website von Flos / It needs an installation box. Compatible DALI interface (IEC 62386-101/102) for controlling indirect lighting. Please note that since it is a DALI compatible component, it may not respond to advanced DALI protocol functions. For more information, see the technical specifications section on the Flos website.

DIVERSION

DESIGNED BY PIERO LISSONI

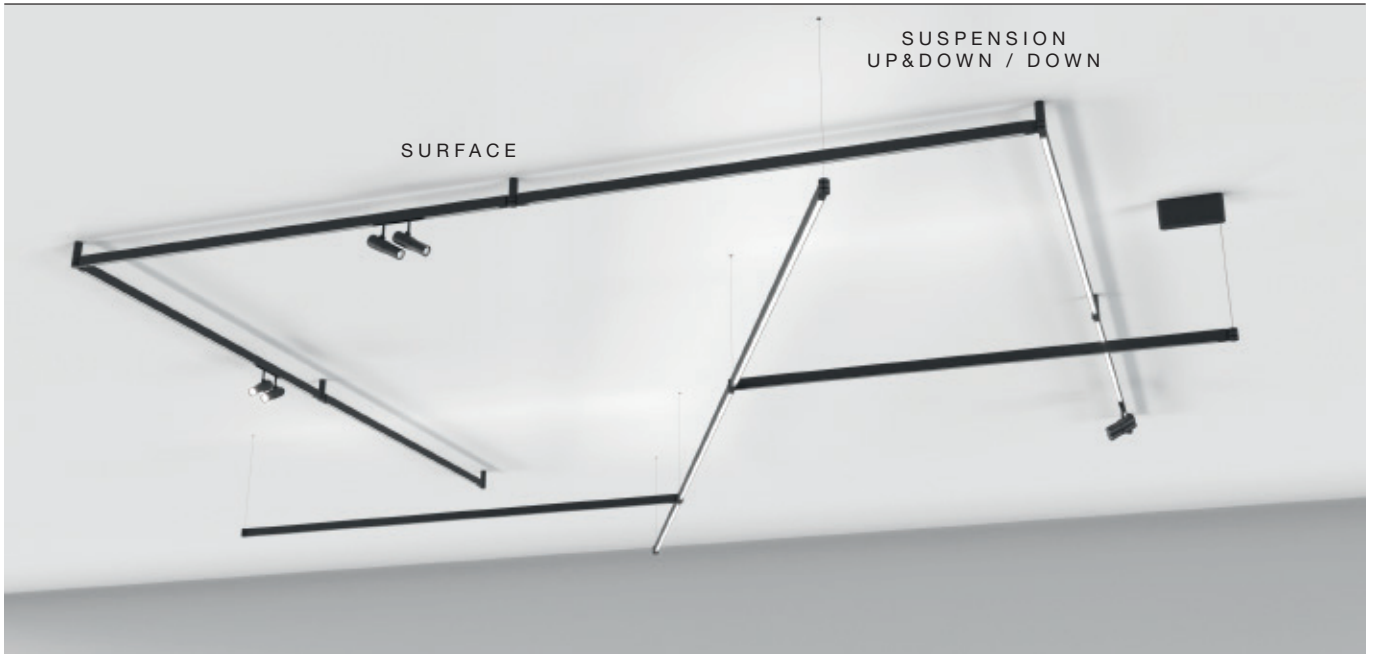

Surface/Suspension Profiles 40 Weiss
40 White 1A Anodic Ice
1A Anodic Ice 14 Schwarz
14 Black CZ Bronze
CZ Bronze

LIGHT MODULES STRUCTURES

DOWN	UP&DOWN	DOWN + SPOTS	UP&DOWN + SPOTS
LIGHT SOURCE TOP LED 13,5W/m 1540 lm/m 2700K/CRI 90 3000K/CRI 90	LIGHT SOURCE TOP LED 20,5W/m 2284 lm/m 2700K/CRI 90 3000K/CRI 90	LIGHT SOURCE TOP LED 11W/m 1255 lm/m 2700K/CRI 90 3000K/CRI 90	LIGHT SOURCE TOP LED 18W/m 1999 lm/m 2700K/CRI 90 3000K/CRI 90

LIGHT MODULES

ATOM 90	ATOM 120
LIGHT SOURCE POWER LED 5,5W 450 lm 2700K/CRI 90 485 lm 3000K/CRI 90	LIGHT SOURCE POWER LED 8W 635 lm 2700K/CRI 90 680 lm 3000K/CRI 90

Produktbeschreibung

Dieses innovative Profilsystem für die Aufputz- und Pendelmontage zeichnet sich durch seine hohe Flexibilität aus. Die Profile sind mit einer integrierten Beleuchtung ausgestattet, die direkt und indirekt ausgestrahlt werden kann. Es können zwei Spots hinzugefügt werden, um die Akzentbeleuchtung zu kombinieren. Die für dieses System erhältlichen Strahler sind Teil der von Piero Lissoni entworfenen Atom-Familie.

Das wichtigste Element des Systems ist das Gelenk zum Antreiben und Verbinden von Profilen, mit dem Konfigurationen in einem Winkel von 360 ° erstellt und kann problemlos mit bis zu 8 Profile an das selbe Gelenkstück angeschlossen werden. Hiermit bietet das System eine endlose Anzahl von Kombinationen. Es kann zu jeder erdenklichen Struktur zusammengesetzt und an unterschiedliche architektonische Räume angepasst werden.

Optisches System

- Lineares Profil down - direkte Lichtleistung: Allgemeinbeleuchtung.
- Lineares Profil Up&down - direkte / indirekte Lichtleistung: Allgemeinbeleuchtung.
- Lineares Profil Down + 2 Spots - direkte Lichtleistung und Akzentbeleuchtung: Allgemeinbeleuchtung, Spot, Medium.
- Lineares Profil Up&down + 2 Spots - direkte / indirekte Lichtleistung und Akzentbeleuchtung: Allgemeinbeleuchtung, Spot, Medium.

Einspeisung

Das System kann über eine nicht mitgelieferte Fernbedienung mit Strom versorgt werden. Die empfohlenen Treiber müssen separat bestellt werden.

Regulierungssystem

System gesteuert durch Treiber 1-10V, DALI oder Casambi. Broadcast-Steuerungssystem. Die Regelung für die Up & Down-Version erfolgt gleichzeitig, es ist nicht möglich, dass die obere und untere Emission unabhängig voneinander gesteuert werden. Für das individuelle Dimmen mittels Casambi sind Casambi-Spots zu verwenden, mit nicht dimmbarer Stromversorgung.

Zusatzinformationen

Zusätzliche Informationen Elektrische Anlage wird mit 24 V Gleichstrom betrieben und ist auf einen maximalen Strom von 5 A und 120 W begrenzt. Schutzgrad IP20. Auf normal entflammbaren Oberflächen einsetzbar.

Qualitätszeichen

Das Gerät entspricht der europäischen technischen Norm EN60598-1 und den entsprechenden Zusatzregelungen.

Description

This innovative profile system for surface and suspended installation is characterized by its high flexibility. Profiles are equipped with integrated lighting available in direct and indirect emission with the possibility of adding two spots in order to combine accent and detail lighting. The spotlights available for this system are part of the Atom family designed by Piero Lissoni.

The key part of the system is the joint for powering and joining profiles together, which allows to create configurations in 360 °, every 45°, as well as to easily connect up to 8 profiles to the same joint piece. Herewith, the system offers an endless number of combinations. It can be composed to create any imaginable structure and can be adapted to different architectural spaces. System of extruded aluminum profiles from 1m up to 2.5m in white, black, anodic ice and bronze finish.

Optic system

- Down linear profile - direct light output: General lighting.
- Up&down linear profile - direct/indirect light output: General lighting.
- Down linear profile + 2 spots - direct light output and accent lighting: General lighting, Spot, Medium.
- Up&down linear profile + 2 spots - direct/indirect light output and accent lighting: General lighting, Spot, Medium.

Power Supply

The system can be powered by a remote power supply which is not included. Recommended drivers must be ordered separately.

Regulation System

System controlled by 1-10V, DALI or Casambi. Broadcast control system. The light dimming for the up&down version can only happen simultaneously. The upper and lower emission cannot be controlled individually. For individual regulation via Casambi, use the Casambi version of spots, with non-dimmable power supply.

Additional Information

Electrical system powered at 24Vdc and limited to a maximum current of 5A and a maximum power of 120W. IP20 protection grade. Suitable for installation on normally inflammable surfaces.

Standard Compliance and Quality Marks

EN60598-1 European Technical Standards and any subsequent additions.

FLOS
CONTROL BY CASAMBI



HOW TO ORDER

1 CHOOSE YOUR PROFILE AND LENGTH

DOWN PROFILE

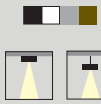

L: 1 / 1,5 / 2 / 2,5 m

UP&DOWN PROFILE

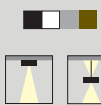

L: 1 / 1,5 / 2 / 2,5 m

DOWN + SPOTS PROFILE

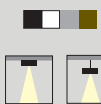

L: 1 / 1,5 / 2 / 2,5 m

UP&DOWN + SPOTS PROFILE

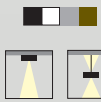

L: 1 / 1,5 / 2 / 2,5 m

2 COMPLETE WITH MOUNTING ACCESSORIES



Accessories

Surface joint



Mechanical

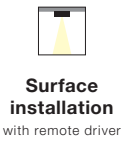

Accessories

Recessed power joint



Electrical and mechanical

or

Recessed power joint with rose



Electrical and mechanical

Surface joint



Mechanical



or



1-10V / Non Dimmable

(select the driver with the appropriate power according to the needs of your project)

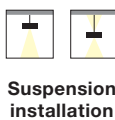

Accessories

Recessed joint



Mechanical

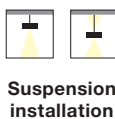

Power suspension joint



Electrical and mechanical

or

Recessed power joint with rose



Electrical and mechanical

Suspension joint



Mechanical



or



1-10V

(select the driver with the appropriate power according to the needs of your project)

DIVERSION

3 SELECT POWER SUPPLY AND CONTROL OPTION

Surface installation

Surface power supply



1-10 / Dali broadcast / Casambi broadcast

Recessed installation



120W - 110 - 240 V

**Dali
broadcast**



57W - 220 - 240 V



**Casambi
broadcast**

(select the driver with
the appropriate power
according to the needs
of your project)

Surface installation

Surface power supply



1-10V / Dali broadcast / Casambi broadcast

Suspension installation



120W - 110 - 240 V

**Dali
broadcast**



57W - 220 - 240 V



120W - 110 - 240 V

**Casambi
broadcast**

(select the driver with
the appropriate power
according to the needs
of your project)

4 SELECT A LIGHT MODULE AND CONTROL OPTION

Atom 90



S/M

Atom 120



S/M

Atom 90



S/M

Casambi

Atom 120



S/M

Casambi

DIVERSION – LIGHT MODULES STRUCTURES

Diversion Down

Light Source: Top LED 13,5 W/m - 1540 lm/m - 2700K/CRI 90 - 3000K/CRI 90

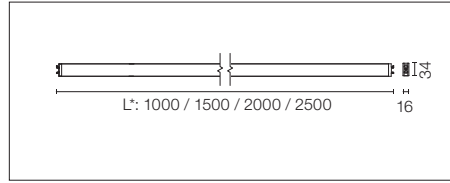

Elektromechanisches Innenprofil mit integrierter direkter linearer Beleuchtung für Oberflächen- oder Aufhängungsinstallation. Mit Längen von 1 bis 2,5 m* (Abstand zwischen den Kugelgelenkzentren). Fixierung mittels Aufhängeset mit Kugelgelenk. Es ist erforderlich, ein separates Aufhängeset und ein mechanisches Kugelgelenk zu bestellen. System wird durch 1-10V, DALI oder Casambi kontrolliert. Broadcast-Steuerungssystem. Dimmer nicht enthalten.

Electro-mechanical profile for indoor application with integrated direct linear light element for surface or suspended installation. With lengths varying from 1 to 2.5m* (distance between ball joint centers). Fixation by a joint with power kit. Power kit and mechanical joint must be ordered separately. System controlled by 1-10V driver, DALI or Casambi. Broadcast control system. Dimmer not included.

2700K

L: 1000 mm -13,5W - 1540 lm

- 09.8000.40
- 09.8000.1A
- 09.8000.14
- 09.8000.CZ

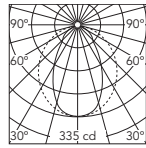

Beam Angle: 62°

h(m)	E(lx)	D(m)
1	335	1.21
2	84	2.41
3	37	3.62
4	21	4.82
5	13	6.03

3000K

L: 1000 mm -13,5W - 1540 lm

- 09.8001.40
- 09.8001.1A
- 09.8001.14
- 09.8001.CZ

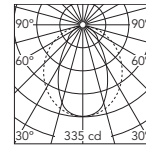

Beam Angle: 62°

h(m)	E(lx)	D(m)
1	335	1.21
2	84	2.41
3	37	3.62
4	21	4.82
5	13	6.03

L: 1500 mm - 20,5W - 2310 lm

- 09.8002.40
- 09.8002.1A
- 09.8002.14
- 09.8002.CZ

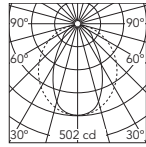

Beam Angle: 62°

h(m)	E(lx)	D(m)
1	502	1.21
2	125	2.41
3	56	3.62
4	31	4.82
5	20	6.03

L: 1500 mm - 20,5W - 2310 lm

- 09.8003.40
- 09.8003.1A
- 09.8003.14
- 09.8003.CZ

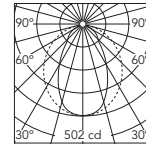

Beam Angle: 62°

h(m)	E(lx)	D(m)
1	502	1.21
2	125	2.41
3	56	3.62
4	31	4.82
5	20	6.03

L: 2000 mm - 27,5W - 3080 lm

- 09.8004.40
- 09.8004.1A
- 09.8004.14
- 09.8004.CZ

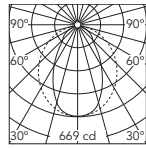

Beam Angle: 62°

h(m)	E(lx)	D(m)
1	669	1.21
2	167	2.41
3	74	3.62
4	42	4.82
5	27	6.03

L: 2000 mm - 27,5W - 3080 lm

- 09.8005.40
- 09.8005.1A
- 09.8005.14
- 09.8005.CZ

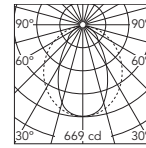

Beam Angle: 62°

h(m)	E(lx)	D(m)
1	669	1.21
2	167	2.41
3	74	3.62
4	42	4.82
5	27	6.03

L: 2500 mm - 34,5W - 3850 lm

- 09.8006.40
- 09.8006.1A
- 09.8006.14
- 09.8006.CZ

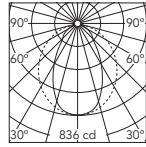

Beam Angle: 62°

h(m)	E(lx)	D(m)
1	836	1.21
2	209	2.41
3	93	3.62
4	52	4.82
5	33	6.03

L: 2500 mm - 34,5W - 3850 lm

- 09.8007.40
- 09.8007.1A
- 09.8007.14
- 09.8007.CZ

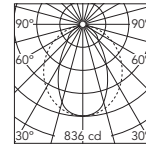

Beam Angle: 62°

h(m)	E(lx)	D(m)
1	836	1.21
2	209	2.41
3	93	3.62
4	52	4.82
5	33	6.03

@White (40)

@White (40)

DIVERSION – LIGHT MODULES STRUCTURES

Diversion Up&Down

Light Source: Top LED 20,5 W/m - 744 lm/m UP - 1540 lm/m DOWN - 2700K/CRI 90 - 3000K/CRI 90

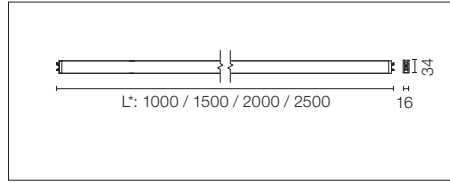

Elektromechanisches Innenprofil mit integrierter direkter und indirekter linearer Beleuchtung für die Oberflächen- oder Aufhängeinstallation. Mit Längen von 1 bis 2,5 m* (Abstand zwischen den Kugelgelenkzentren). Mit Befestigung durch Aufhängungset angetrieben und durch Kugelgelenk angetrieben und durch Kugelgelenk aufgehängt. Es ist erforderlich, ein separates Aufhängungset und ein mechanisches Kugelgelenk zu bestellen. System wird durch 1-10V, DALI oder Casambi kontrolliert. Broadcast-Steuerungssystem. Dimmer nicht enthalten.

Electro-mechanical profile for indoor application with integrated direct and indirect linear light element for surface or suspended installation. With lengths varying from 1 to 2.5m* (distance between ball joint centers). Fixation by fed suspension kit and suspended by a joint. Power kit and mechanical joint must be ordered separately. System controlled by 1-10V driver, DALI or Casambi. Broadcast control system. Dimmer not included.

2700K

L: 1000 mm - 20,5W
744 lm UP - 1540 lm DOWN

- 09.8010.40
- 09.8010.1A
- 09.8010.14
- 09.8010.CZ

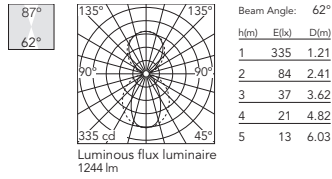

3000K

L: 1000 mm - 20,5W
744 lm UP - 1540 lm DOWN

- 09.8011.40
- 09.8011.1A
- 09.8011.14
- 09.8011.CZ

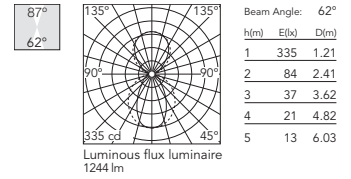

L: 1500 mm - 32W
1116 lm UP - 2310 lm DOWN

- 09.8012.40
- 09.8012.1A
- 09.8012.14
- 09.8012.CZ

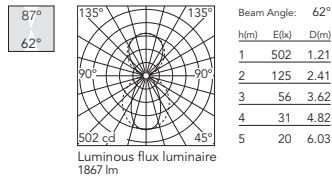

L: 1500 mm - 32W
1116 lm UP - 2310 lm DOWN

- 09.8013.40
- 09.8013.1A
- 09.8013.14
- 09.8013.CZ

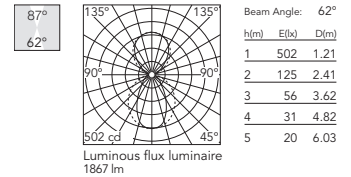

L: 2000 mm - 43W
1488 lm UP - 3080 lm DOWN

- 09.8014.40
- 09.8014.1A
- 09.8014.14
- 09.8014.CZ

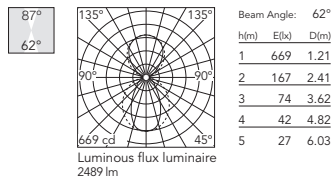

L: 2000 mm - 43W
1488 lm UP - 3080 lm DOWN

- 09.8015.40
- 09.8015.1A
- 09.8015.14
- 09.8015.CZ

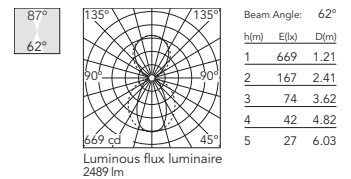

L: 2500 mm - 54,5W
1860 lm UP - 3850 lm DOWN

- 09.8016.40
- 09.8016.1A
- 09.8016.14
- 09.8016.CZ

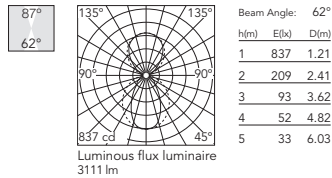

L: 2500 mm - 54,5W
1860 lm UP - 3850 lm DOWN

- 09.8017.40
- 09.8017.1A
- 09.8017.14
- 09.8017.CZ

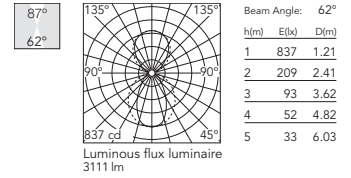

@White (40)

@White (40)

DIVERSION – LIGHT MODULES STRUCTURES

Diversion Down + Spots

Light Source: Top LED 11W/m* - 1255 lm/m - 2700K/CRI 90 - 3000K/CRI 90

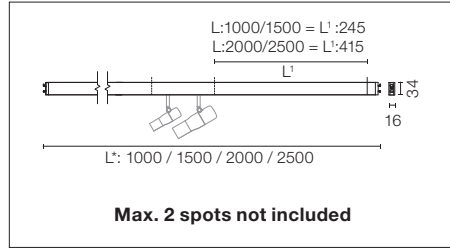

Elektromechanisches Innenprofil mit integrierter direkter linearer Beleuchtung und Platz für zwei Spots für Aufputz- oder Aufhängeinstallation. Mit Längen von 1 bis 2,5 m* (Abstand zwischen den Kugelgelenkzentren). Mit Befestigung durch Aufhängungssatz angetrieben und durch Kugelgelenk aufgehängt. Es ist erforderlich, ein separates Aufhängungsset und ein mechanisches Kugelgelenk zu bestellen.

System wird durch 1-10V, DALI oder Casambi kontrolliert. Broadcast-Steuerungssystem. Dimmer nicht enthalten.

Bei Einzelprofilkonstruktionen in abgehängter Ausführung den Punkt ausgleichen, um ein Kippen des Profils zu vermeiden.

Electro-mechanical profile for indoor application with integrated direct linear light element and space for two spots, for surface or suspended installation. With lengths varying from 1 to 2.5m* (distance between ball joint centers). Fixation by fed suspension kit and suspended by a joint. Power kit and mechanical joint must be ordered separately.

System controlled by 1-10V driver, DALI or Casambi. Broadcast control system. Dimmer not included.

For single profile structures, suspended version, balance the spot to avoid profile tilting.

2700K

L: 1000 mm - 11W - 1255 lm

- 09.8020.40
- 09.8020.1A
- 09.8020.14
- 09.8020.CZ

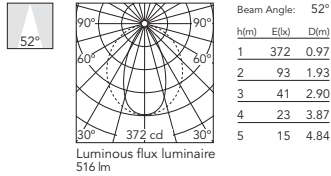

3000K

L: 1000 mm - 11W - 1255 lm

- 09.8021.40
- 09.8021.1A
- 09.8021.14
- 09.8021.CZ

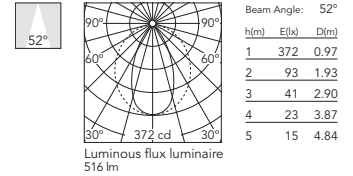

L: 1500 mm - 18W - 2097 lm

- 09.8022.40
- 09.8022.1A
- 09.8022.14
- 09.8022.CZ

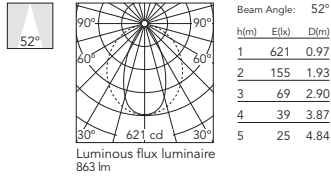

L: 1500 mm - 18W - 2097 lm

- 09.8023.40
- 09.8023.1A
- 09.8023.14
- 09.8023.CZ

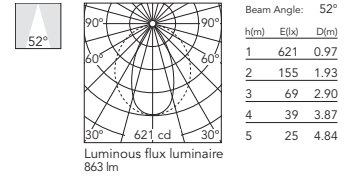

L: 2000 mm - 25W - 2939 lm

- 09.8024.40
- 09.8024.1A
- 09.8024.14
- 09.8024.CZ

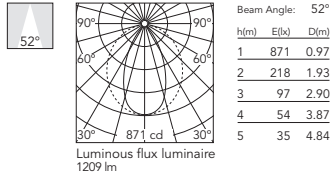

L: 2000 mm - 25W - 2939 lm

- 09.8025.40
- 09.8025.1A
- 09.8025.14
- 09.8025.CZ

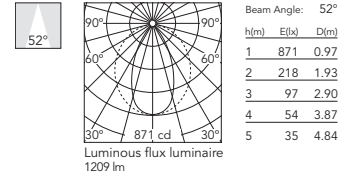

L: 2500 mm - 32W - 3781 lm

- 09.8026.40
- 09.8026.1A
- 09.8026.14
- 09.8026.CZ

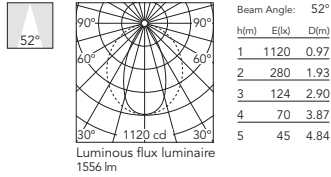

L: 2500 mm - 32W - 3781 lm

- 09.8027.40
- 09.8027.1A
- 09.8027.14
- 09.8027.CZ

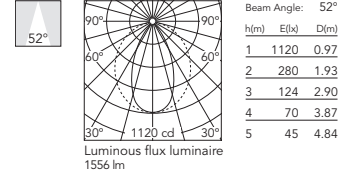

* Leistung ohne Spots / Power without spots.

DIVERSION – LIGHT MODULES STRUCTURES

Diversion Up&Down + Spots

Light Source: Top LED 18W/m* - 1999 lm/m - 2700K/CRI 90 - 3000K/CRI 90

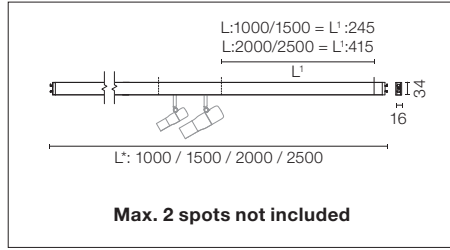

Elektromechanisches Innenprofil mit integrierter direkter linearer Beleuchtung und Platz für zwei Spots für Aufputz- oder Aufhängeinstallation. Mit Längen von 1 bis 2,5 m* (Abstand zwischen den Kugelgelenkzentren). Mit Befestigung durch Aufhängungsatz angetrieben und durch Kugelgelenk aufgehängt. Es ist erforderlich, ein separates Aufhängungsset und ein mechanisches Kugelgelenk zu bestellen.

System wird durch 1-10V, DALI oder Casambi kontrolliert. Broadcast-Steuerungssystem. Dimmer nicht enthalten.

Bei Einzelprofilkonstruktionen in abgehängter Ausführung den Punkt ausgleichen, um ein Kippen des Profils zu vermeiden.

Electro-mechanical profile for indoor application with integrated direct linear light element and space for two spots, for surface or suspended installation. With lengths varying from 1 to 2.5m* (distance between ball joint centers). Fixation by fed suspension kit and suspended by a joint. Power kit and mechanical joint must be ordered separately.

System controlled by 1-10V driver, DALI or Casambi. Broadcast control system. Dimmer not included.

For single profile structures, suspended version, balance the spot to avoid profile tilting.

2700K

L: 1000 mm - 18W
744 lm UP - 1255 lm DOWN

- 09.8030.40
- 09.8030.1A
- 09.8030.14
- 09.8030.CZ

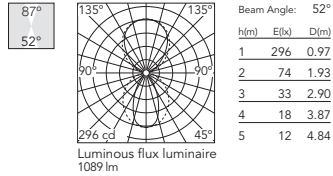

L: 1500 mm - 29,5W
1166 lm UP - 2097 lm DOWN

- 09.8032.40
- 09.8032.1A
- 09.8032.14
- 09.8032.CZ

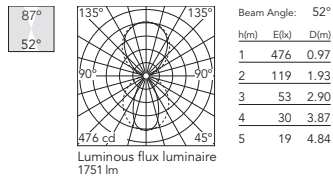

L: 2000 mm - 40,5W
1488 lm UP - 2939 lm DOWN

- 09.8034.40
- 09.8034.1A
- 09.8034.14
- 09.8034.CZ

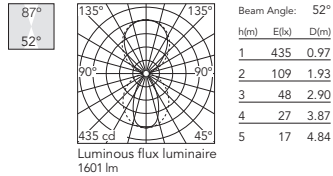

L: 2500 mm - 52W
1816 lm UP - 3781 lm DOWN

- 09.8036.40
- 09.8036.1A
- 09.8036.14
- 09.8036.CZ

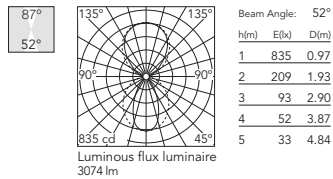

3000K

L: 1000 mm - 18W
744 lm UP - 1255 lm DOWN

- 09.8031.40
- 09.8031.1A
- 09.8031.14
- 09.8031.CZ

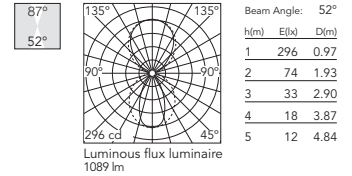

L: 1500 mm - 29,5W
1166 lm UP - 2097 lm DOWN

- 09.8033.40
- 09.8033.1A
- 09.8033.14
- 09.8033.CZ

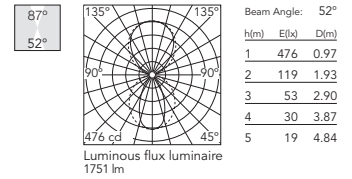

L: 2000 mm - 40,5W
1488 lm UP - 2939 lm DOWN

- 09.8035.40
- 09.8035.1A
- 09.8035.14
- 09.8035.CZ

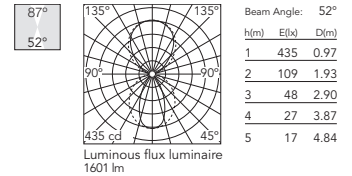

L: 2500 mm - 52W
1816 lm UP - 3781 lm DOWN

- 09.8037.40
- 09.8037.1A
- 09.8037.14
- 09.8037.CZ

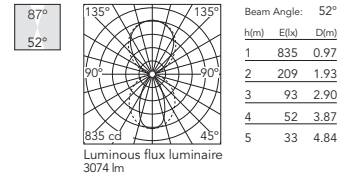

* Leistung ohne Spots / Power without spots.

DIVERSION – LIGHT MODULES

Atom 90 Designed By Piero Lissoni

Light Source: Power LED 5,5W - 450 lm - 2700K/CRI 90 / 5,5W - 485 lm - 3000K/CRI 90

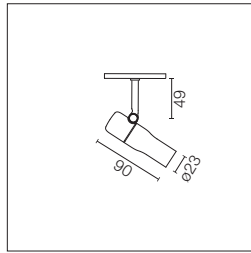

LED-Akzentbeleuchtungsmodul zum Einbau in das Diversion-System. Elektronischer DC / DC-Wandler eingebaut. System gesteuert durch Treiber 1-10V, DALI oder Casambi. Broadcast Steuerungssystem. Dimmer nicht enthalten. Für die individuelle Steuerung der Spots mittels Casambi sind Casambi-Spots auszuwählen. Inkludiertes Zubehör (Honeycomb und Blendschutzgitter).

LED accent lighting module to be installed in the Diversion system. Electronic DC/DC converter incorporated. System controlled by 1-10V, DALI or Casambi. Broadcast control system. Dimmer not included. To individually control the spots via Casambi, choose the Casambi version of spots. Accessories included (honeycomb and screening crosspiece).

- 2700K**
- 09.3831.40A
 - 09.3831.1AA
 - 09.3831.14A
 - 09.3831.CZA
 - Casambi
 - 09.3931.40A
 - 09.3931.14A
 - 09.3931.CZA

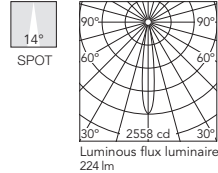

Beam Angle: 14°

h(m)	E(lx)	D(m)
1	2558	0.25
2	640	0.51
3	284	0.76
4	160	1.02
5	102	1.27

- 3000K**
- 09.3830.40A
 - 09.3830.1AA
 - 09.3830.14A
 - 09.3830.CZA
 - Casambi
 - 09.3930.40A
 - 09.3930.14A
 - 09.3930.CZA

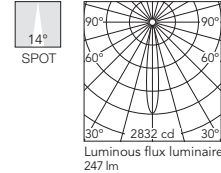

Beam Angle: 14°

h(m)	E(lx)	D(m)
1	2832	0.25
2	708	0.51
3	315	0.76
4	177	1.02
5	113	1.27

- 2700K**
- 09.3833.40A
 - 09.3833.1AA
 - 09.3833.14A
 - 09.3833.CZA
 - Casambi
 - 09.3933.40A
 - 09.3933.14A
 - 09.3933.CZA

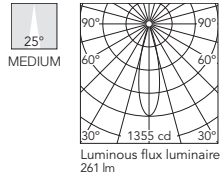

Beam Angle: 25°

h(m)	E(lx)	D(m)
1	1355	0.45
2	339	0.89
3	151	1.34
4	85	1.79
5	54	2.23

- 3000K**
- 09.3832.40A
 - 09.3832.1AA
 - 09.3832.14A
 - 09.3832.CZA
 - Casambi
 - 09.3932.40A
 - 09.3932.14A
 - 09.3932.CZA

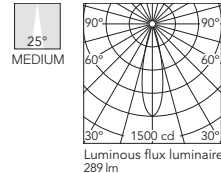

Beam Angle: 25°

h(m)	E(lx)	D(m)
1	1500	0.45
2	375	0.89
3	167	1.34
4	94	1.79
5	60	2.23

Atom 120 Designed By Piero Lissoni

Light Source: Power LED 8W - 635 lm - 2700K/CRI 90 / 8W - 680 lm - 3000K/CRI 90

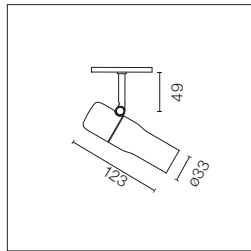

LED-Akzentbeleuchtungsmodul zum Einbau in das Diversion-System. Elektronischer DC / DC-Wandler eingebaut. System gesteuert durch Treiber 1-10V, DALI oder Casambi. Broadcast Steuerungssystem. Dimmer nicht enthalten. Für die individuelle Steuerung der Spots mittels Casambi sind Casambi-Spots auszuwählen. Inkludiertes Zubehör (Honeycomb und Blendschutzgitter).

LED accent lighting module to be installed in the Diversion system. Electronic DC/DC converter incorporated. System controlled by 1-10V, DALI or Casambi. Broadcast control system. Dimmer not included. To individually control the spots via Casambi, choose the Casambi version of spots. Accessories included (honeycomb and screening crosspiece).

- 2700K**
- 09.3841.40A
 - 09.3841.1AA
 - 09.3841.14A
 - 09.3841.CZA
 - Casambi
 - 09.3941.40A
 - 09.3941.14A
 - 09.3941.CZA

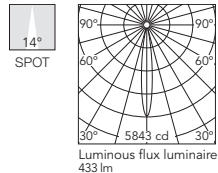

Beam Angle: 14°

h(m)	E(lx)	D(m)
1	5843	0.24
2	1461	0.48
3	649	0.72
4	365	0.95
5	234	1.19

- 3000K**
- 09.3840.40A
 - 09.3840.1AA
 - 09.3840.14A
 - 09.3840.CZA
 - Casambi
 - 09.3940.40A
 - 09.3940.14A
 - 09.3940.CZA

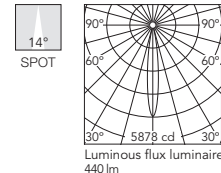

Beam Angle: 14°

h(m)	E(lx)	D(m)
1	5878	0.24
2	1469	0.49
3	653	0.73
4	367	0.97
5	235	1.21

- 2700K**
- 09.3843.40A
 - 09.3843.1AA
 - 09.3843.14A
 - 09.3843.CZA
 - Casambi
 - 09.3943.40A
 - 09.3943.14A
 - 09.3943.CZA

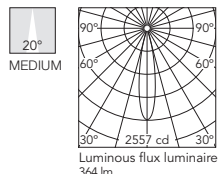

Beam Angle: 20°

h(m)	E(lx)	D(m)
1	2557	0.35
2	639	0.70
3	284	1.06
4	160	1.41
5	102	1.76

- 3000K**
- 09.3842.40A
 - 09.3842.1AA
 - 09.3842.14A
 - 09.3842.CZA
 - Casambi
 - 09.3942.40A
 - 09.3942.14A
 - 09.3942.CZA

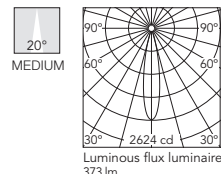

Beam Angle: 20°

h(m)	E(lx)	D(m)
1	2624	0.35
2	656	0.70
3	292	1.06
4	164	1.41
5	105	1.76

DIVERSION – DRIVERS

Treiber / Drivers

Remote Installation
Fernspeisung.
Dimmbar durch 1/10V Protokoll
oder No Dimable. 24V.
Dimmbereich 20-100%

Remote power supply.
Dimmable through 1/10V
protocol or Non Dimmable. 24V.
Dimming range 20-100%

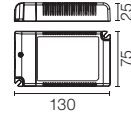

57W - 220/240V
60.9361

Fernspeisung.
Dimmbar durch
0-1/10V-Protokoll 24V.
Dimmbereich 10-100%.
Mindestlast 20W

Remote power supply.
Dimmable through 0-1/10V.
protocol. 24V. Dimming range
10-100%. Minimum load 20W

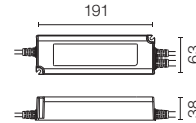

120W - 110*/240V
60.9681

*UL max 100W

Fernspeisung.
Dimmbar durch DALI-Protokoll.
24V. Dimmbereich 10-100%.
Mindestlast 20W

Remote power supply.
Dimmable through DALI
protocol. 24V. Dimming range
10-100%. Minimum load 20W

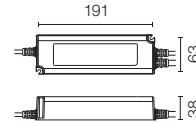

120W - 110*/240V
60.9682

*UL max 100W

Casambi

Remote Installation
Fernspeisung. Dimmbar durch
Casambi-Protokoll. 24V.
Dimmbereich 10-100 %. Mindestlast
20W

Remote power supply. Dimmable
through Casambi protocol. 24V.
Dimming range 10-100%.

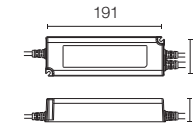

120W - 110*/240V
60.9683

*UL max 100W

Kontroller Casambi.
Nur mit 60.9361 verwenden.
Benötigt 1-10V oder Dali-Treiber,
separat bestellen. Dimmbereich
20-100%

Casambi controller. Use only
with 60.9361. Requires 1-10V or
Dali driver. It must be ordered
separately. Dimming range 20-
100%

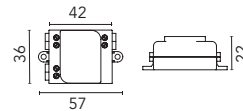

220-240Vac
60.9392

Remote Driver Installations - Broadcast

Driver Option 1
(DALI)

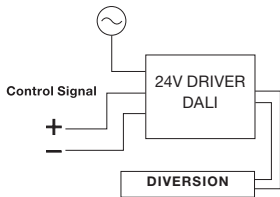

Driver Option 2
(1-10V)

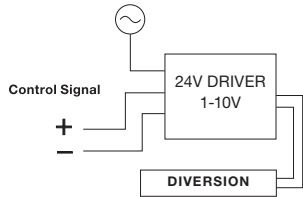

Driver Option 3
Casambi Interface

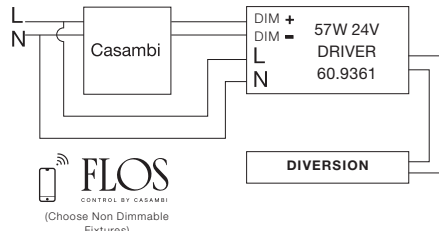

Driver Option 4
CASAMBI

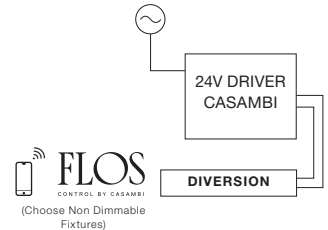

Spots CASAMBI Individual & NO DIM Linear Lights

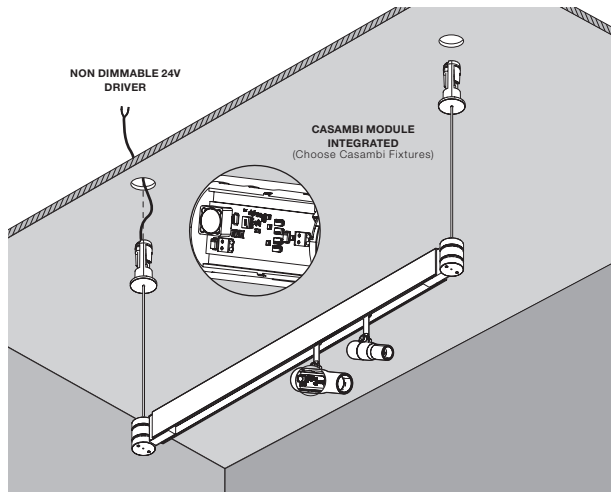

DIVERSION – INSTALLATION

SUSPENSION INSTALLATION

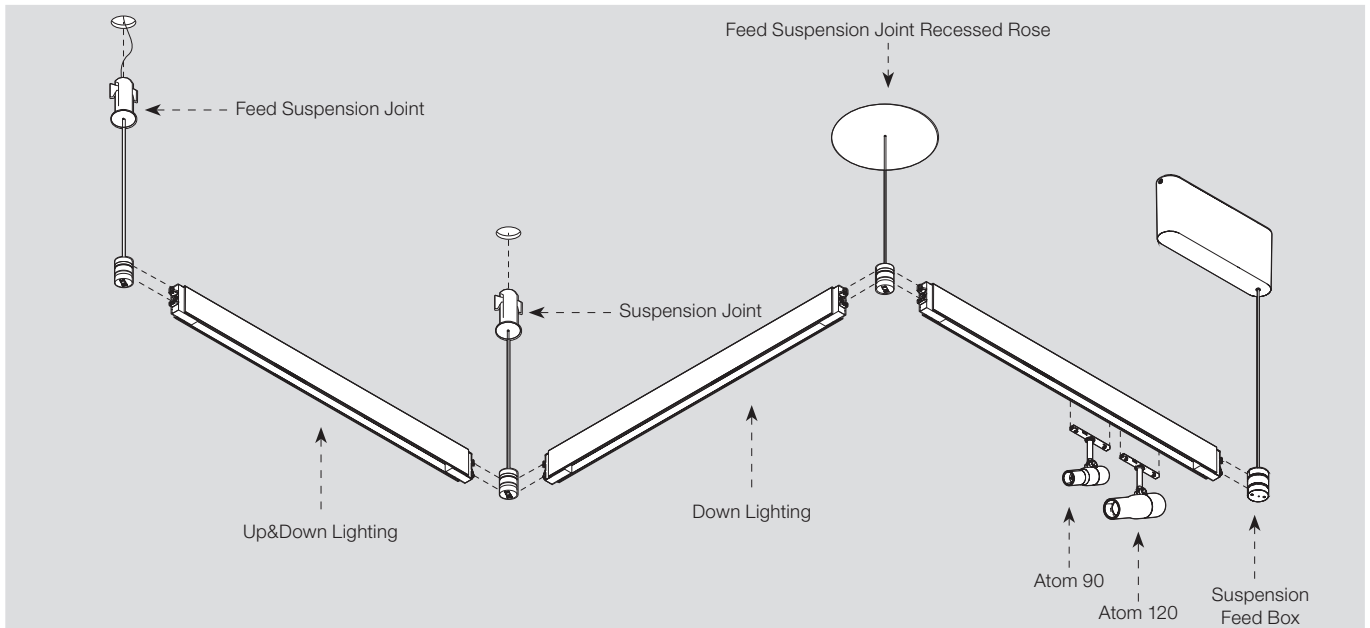

Zubehör / Accessories

Kugelgelenkaufhängung. 24V. Netzkabel: 3800 mm.	Feed suspension joint. 24V. Power cable: 3800 mm.			<ul style="list-style-type: none"> 06.5300.40 06.5300.1A 06.5300.14 06.5300.CZ
Kugelgelenk. Stahldraht 0,6 mm dick und 3800 mm lang.	Suspension joint. 0.6 mm thick, 3800 mm long steel wire.			<ul style="list-style-type: none"> 06.5301.40 06.5301.1A 06.5301.14 06.5301.CZ
Kugelgelenk für versenkte Aufhängung mit Rosette. 24V. Netzkabel: 3800 mm.	Feed suspension joint with rose, for recessing. 24V. Power cable: 3800 mm.			<ul style="list-style-type: none"> 06.5302.40 06.5302.1A 06.5302.14 06.5302.CZ
Hängebox für Aufputzmontage. 24V. Netzkabel: 3800 mm. Treiber enthalten (1-10V/DALI/Casambi).	Suspension feed box, for surface installation. 24V. Power cable: 3800 mm. Driver included (1-10V/DALI/Casambi).			<ul style="list-style-type: none"> 1-10V / 57W - 220-240Vac 06.5310.40 06.5310.1A 06.5310.14 06.5310.CZ *DALI / 57W - 220-240Vac 06.5314.40 06.5314.1A 06.5314.14 06.5314.CZ Casambi / 57W - 220-240Vac 06.5311.40 06.5311.1A 06.5311.14 06.5311.CZ
Deckenabhängung für Aufputzmontage. Stahldraht 0,6 mm dick und 3800 mm lang.	Suspension joint, for surface installation. 0.6 mm thick, 3800 mm long steel wire.			<ul style="list-style-type: none"> 06.5303.40 06.5303.1A 06.5303.14 06.5303.CZ

* Kompatible DALI-Schnittstelle (IEC 62386-101/102). Da es sich um eine kompatible DALI-Komponente handelt, beachten Sie bitte, dass diese nicht auf erweiterte Funktionen des DALI-Protokolls reagieren kann. Weitere Informationen erhalten Sie im Abschnitt der technischen Spezifikationen auf der Website von Flos / Compatible DALI interface (IEC 62386-101/102). Please note that since it is a DALI compatible component, it may not respond to advanced DALI protocol functions. For more information, see the technical specifications section on the Flos website.

DIVERSION – INSTALLATION

SURFACE INSTALLATION

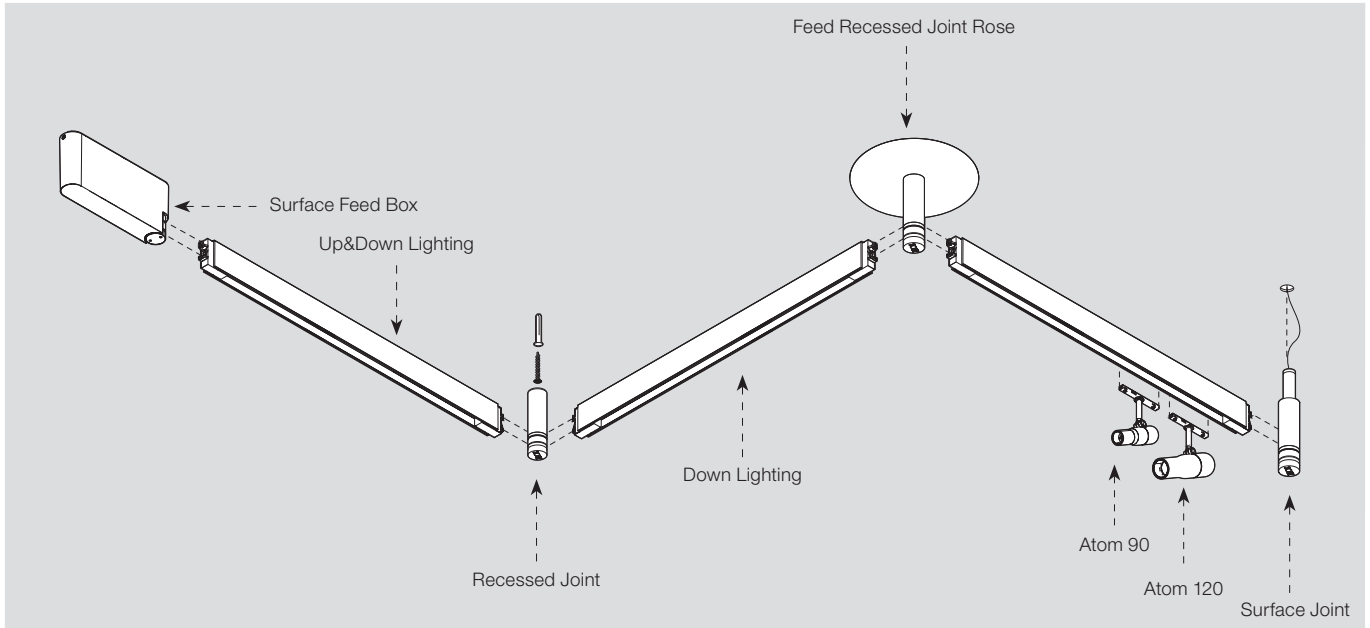

Zubehör / Accessories

Versenktes Kraftgelenk. 24V.

Feed recessed joint. 24V



06.5304.40
06.5304.1A
06.5304.14
06.5304.CZ

Versenkte / Oberflächenverbindung.

Recessed / surface joint.



06.5305.40
06.5305.1A
06.5305.14
06.5305.CZ

Eingelassenes Kraftgelenk mit Rose. 24V.

Feed recessed joint rose. 24V.

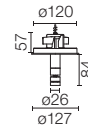

06.5306.40
06.5306.1A
06.5306.14
06.5306.CZ

Aufputzdose, zur Deckenmontage. 24V.
Treiber enthalten (1-10V/DALI/
Casambi).

Surface feed box, for ceiling
installation. 24V.
Driver included (1-10V/DALI/
Casambi).

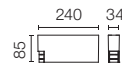

1-10V / 57W - 220-240Vac
06.5312.40
06.5312.1A
06.5312.14
06.5312.CZ
*DALI / 57W - 220-240Vac
06.5315.40
06.5315.1A
06.5315.14
06.5315.CZ
Casambi / 57W - 220-240Vac
06.5313.40
06.5313.1A
06.5313.14
06.5313.CZ

* Kompatible DALI-Schnittstelle (IEC 62386-101/102). Da es sich um eine kompatible DALI-Komponente handelt, beachten Sie bitte, dass diese nicht auf erweiterte Funktionen des DALI-Protokolls reagieren kann. Weitere Informationen erhalten Sie im Abschnitt der technischen Spezifikationen auf der Website von Flos / Compatible DALI interface (IEC 62386-101/102). Please note that since it is a DALI compatible component, it may not respond to advanced DALI protocol functions. For more information, see the technical specifications section on the Flos website.

DIVERSION – FAQ

• Wie viele Profile kann ich mit demselben Netzteil ausstatten?

Die Einschränkung liegt in der Leistung. Bei Verwendung des 120-W-Netzteils muss die Anzahl der Leuchten auf dieses Maximum eingestellt werden.

• Wie viele Profile kann ich mit einer einzelnen Verbindung verbinden?

Es ist möglich bis zu 8 Profile an dieselbe Verbindung anzuschließen.

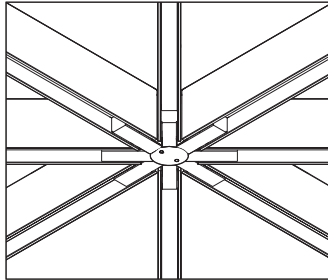

• How many profiles can I feed up with the same driver?

Power is the limit. When using the 120W driver model, the number of luminaires must be adjusted to that maximum consumption.

• How many profiles can I connect to one single joint?

It is possible to connect up to 8 profiles to the same joint.

• Wie viele Profile kann ich mit einem einzigen Vorschubgelenk ausstatten?

Die maximale Stückzahl beträgt 8 Stück à 45°. Die Grenze wird durch ihren Gesamtstromverbrauch dargestellt, der weniger als 120 W betragen muss.

- Beispiel 1; mit 1 m Profilen mit direkter Lichtemission (DOWN).
 Leistungsaufnahme des Beleuchtungsmoduls = 13,5W.
 $120\text{ W} / 13,5\text{ W} = 8,88$ Beleuchtungsmodule, dh maximal 8 Module.
 Die Fuge könnte daher bis zu 8 Lichtmodule punktfrei abstrahlen.

- Beispiel 2; Verwendung von 2,5 m Profilen mit direkter / indirekter Lichtemission (UP & DOWN) mit 2 Atom 120-Spots.
 Leistungsaufnahme des Beleuchtungsmoduls inklusive 2 Spots = $54,5\text{W} + 2 \times 8\text{W} = 70,5\text{W}$.
 $120\text{ W} / 70,5\text{ W} = 1,7$ Module, dh maximal 1 Modul.
 Es ist daher möglich, eine Verbindung herzustellen, bei der nur ein mit zwei Spots ausgestattetes Beleuchtungsmodul UP & DOWN angebracht wird. Um mehr Elemente auf derselben Fuge hinzuzufügen, müssen diese von einer anderen speziellen Fuge zugeführt werden, die sich auf der gegenüberliegenden Seite des Profils befindet.

Stellen Sie sicher, dass Sie die integrierten Switches am Ende jedes Profils konfigurieren. Dadurch wird vermieden, dass mehrere Netzteile geschaltet werden, was zu Fehlfunktionen des gesamten Systems führen würde.

• How many profiles can I feed up with one single feeding joint?

The maximum quantity is 8 pieces, one every 45°. The limit is represented by their total power consumption which has to be less than 120W.

- Example 1; when using 1m profiles with direct light emission (DOWN).
 Lighting module power consumption = 13,5W.
 $120\text{W}/13,5\text{W} = 8,88$ lighting modules, which means 8 modules maximum.
 The joint could therefore feature up to 8 light modules single emission without spots.

- Example 2; when using 2,5m profiles featuring direct/indirect light emission (UP&Down) with 2 Atom 120 spots.
 Lighting module power consumption including 2 spots = $54,5\text{W} + 2 \times 8\text{W} = 70,5\text{W}$.
 $120\text{W}/70,5\text{W} = 1,7$ modules, which means 1 module maximum.
 It is therefore possible to complete a joint attaching only one lighting module Up&Down equipped with two spots. In order to add more elements to the same joint, these will need to be fed by another dedicated joint located on the opposite side of the profile.

Please make sure to set the integrated switches located at the end of each profile. This will avoid switching multiple power supplies, which would cause the entire system to malfunction.

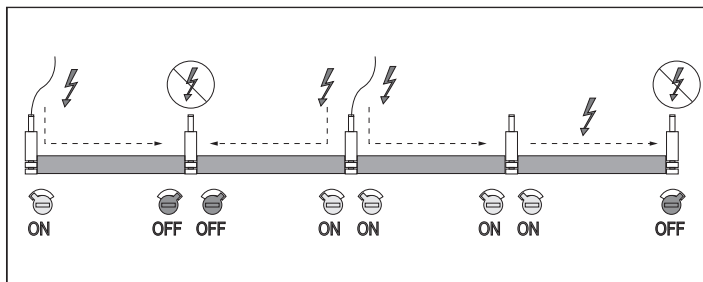
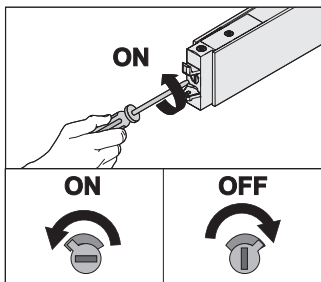

• Kann ich jede einzelne Leuchte einzeln steuern?

Nein, das gesamte System wird gleichzeitig gesteuert (Broadcast). Direkte und indirekte Beleuchtung kann ebenfalls nicht für eine unabhängige Steuerung getrennt werden.
 Die Module mit indirekter Beleuchtung sind mit einem Schalter ausgestattet, mit dem die maximale Leistung um 50% reduziert werden kann, ohne dass die Dimmoptionen DALI, 1-10V oder Casambi beeinträchtigt werden.

• Can I control each luminaire individually?

No, the entire system is controlled simultaneously (broadcast). Direct and indirect lighting cannot be separated for independent control either.
 Modules with indirect illumination are equipped with a switch to reduce the maximum power of 50%, establishing it as the maximum without affecting the DALI, 1-10V or Casambi dimming options.

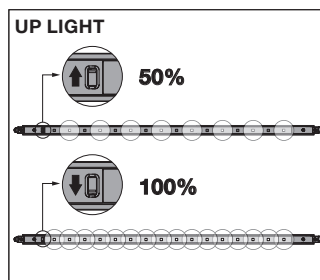

DIVERSION – FAQ

• Welches ist beim Oberflächenvorschub das größte Profil das ich installieren kann?

- Up&Down - 2500mm
- Up&Down + 2 Spots - 2000m
- Down - 2500mm
- Down + 2 Spots - 2500mm

• Welche Konfigurationen kann ich mit dem Umleitungssystem vornehmen?

Als Beispiel zeigen wir die folgenden Konfigurationen; Die Möglichkeiten sind nahezu unbegrenzt, wenn man bedenkt, dass der minimale Drehwinkel zwischen den Profilen 45 ° beträgt und die maximale Last vom ausgewählten Netzteil abhängt.

(Das Netzteil ist nicht im Lieferumfang enthalten. Je nach Installation kann der Treiber remote oder in speziellen Boxen auf der Oberfläche oder in Aufhängung installiert werden).

• Which is the biggest profile I can install with the surface power supply?

- Up&Down - 2500mm
- Up&Down + 2 Spots - 2000m
- Down - 2500mm
- Down + 2 Spots - 2500mm

• Which kind of layouts can be designed with Diversion?

As an example, we show the following compositions; the possibilities of configuration with this system are almost endless considering that the minimum angle between two profiles is 45° and the maximum load depends on the feeding equipment selected.

(Feeding equipment is not included, depending on the installation, the equipment can be remote or with suspension or surface boxes).

Example No.1

- 6 x Light Module Diversion Down + Spots - L 1000 mm
- 2 x Light Module Diversion Down - L 1000 mm
- 12 x Atom 120
- 5 x Joint
- 2 x Power Joint

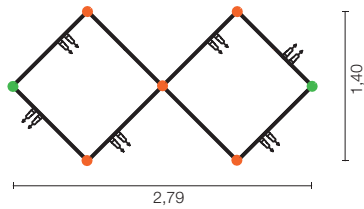

Example No.3

- 4 x Light Module Diversion Down + Spots - L 1000 mm
- 2 x Light Module Diversion Down - L 1000 mm
- 8 x Atom 120
- 4 x Joint
- 2 x Power Joint

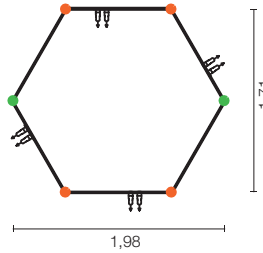

Example No.5

- 5 x Light Module Diversion Down + Spots - L 1000 mm
- 3 x Light Module Diversion Down - L 1000 mm
- 1 x Light Module Diversion Down + Spots - L 1500 mm
- 1 x Light Module Diversion Down - L 1500 mm
- 1 x Light Module Diversion Down + Spots - L 2000 mm
- 1 x Light Module Diversion Down - L 2000 mm
- 14 x Atom 90
- 6 x Joint
- 3 x Power Joint

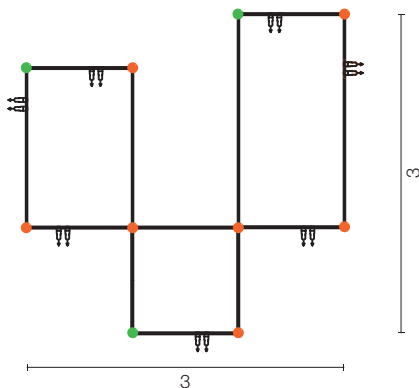

Example No.2

- 6 x Light Module Diversion Down + Spots - L 1000 mm
- 2 x Light Module Diversion Down - L 1000 mm
- 12 x Atom 90
- 1 x Power Joint Suspension
- 3 x Joint Suspension
- 1 x Power Joint Surface
- 3 x Joint Surface

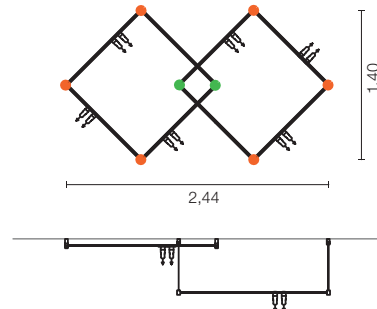

Example No.4

- 3 x Light Module Diversion Down + Spots - L 1000 mm
- 6 x Atom 90
- 3 x Joint
- 1 x Power Joint

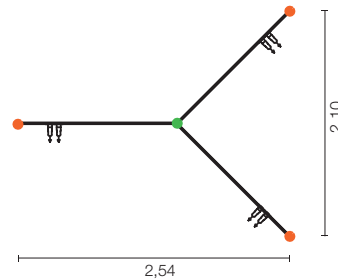

Example No.6

- 3 x Light Module Diversion Up&Down + Spots - L 1500 mm
- 6 x Atom 90
- 3 x Joint
- 1 x Power Joint

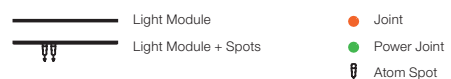
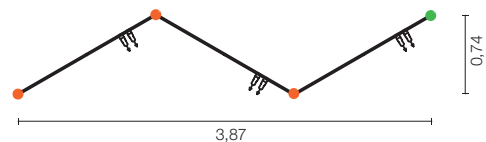

ZERO TRACK

DESIGNED BY FLOS ARCHITECTURAL



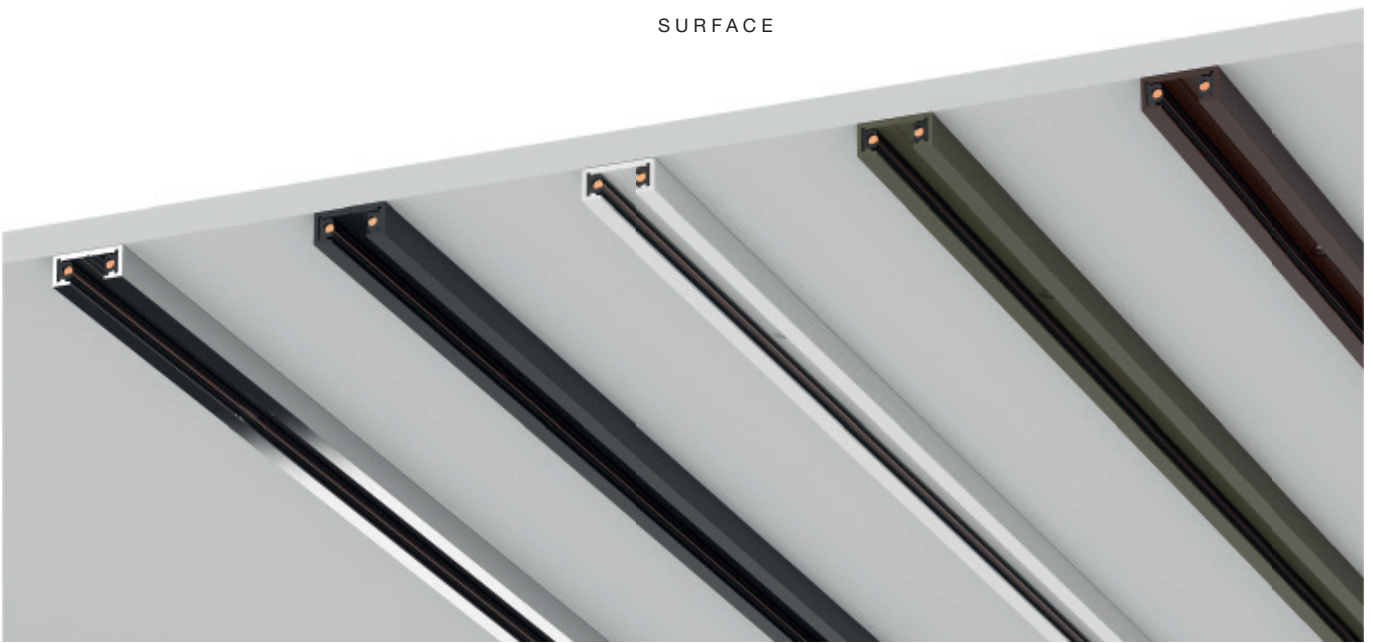





SURFACE



Surface Profiles

 40 Weiss	 06 Chrom	 14 Schwarz	 CZ Bronze	 18 Deep brown
 40 White	 06 Chrome	 14 Black	 CZ Bronze	 18 Deep brown

LIGHT MODULES

FIND ME 0	FIND ME 1	FIND ME 2	FIND ME 1 SUSPENSION
			
			
LIGHT SOURCE POWER LED 3,5W 300 lm 2700K/CRI 90 325 lm 3000K/CRI 90	LIGHT SOURCE POWER LED 5,5W 450 lm 2700K/CRI 90 485 lm 3000K/CRI 90	LIGHT SOURCE POWER LED 10,5W 650 lm 2700K/CRI 90 700 lm 3000K/CRI 90	LIGHT SOURCE POWER LED 5,5W 450 lm 2700K/CRI 90 485 lm 3000K/CRI 90

ATOM 90	ATOM 120	ATOM 200
		
		
LIGHT SOURCE POWER LED 5,5W 450 lm 2700K/CRI 90 485 lm 3000K/CRI 90	LIGHT SOURCE POWER LED 8W 635 lm 2700K/CRI 90 680 lm 3000K/CRI 90	LIGHT SOURCE POWER LED 10,5W 1050 lm 2700K/CRI 90 1150 lm 3000K/CRI 90

Produktbeschreibung

Dieses neue Profilsystem für die Oberflächeninstallation zeichnet sich durch seine reduzierten Abmessungen aus, wodurch es eine minimalistische Ästhetik erhält, die in verschiedenen architektonischen Räumen sehr geschätzt wird. Für Lösungen in nicht begehbaren Decken verfügt das System über integrierte, dimmbare Stromversorgungen über Rundfunksteuerungssysteme mit 1-10 V.

Verfügbare Fernspeisequellen, dimmbar mittels 1-10V-, DALI- und Casambi-Broadcastsysteme. Bei Aufputzmontage erfolgt das Dimmen mittels 1-10V-Protokoll. Casambi-System für individuelles Bluetooth-Dimmen jeder einzelnen Lichteinheit mittels der APP FLOS Control® powered by Casambi für Mobilgeräte (verfügbar im Apple Store und auf Google Play). Das System aus Aluminiumschienen bis zu 3 m wurde in weiß, schwarz, deep brown, bronze und chrom stranggepresst. Sie sind mit elektrischen Stromspuren ausgestattet, die mit 24 VDC gespeist werden.

Optisches System

- Find Me 0: Spot, Medium.
- Find Me 1: Spot, Medium.
- Find Me 2: Spot, Medium, Flood.
- Find Me 1 Suspension: Spot, Medium.
- Atom 90: Spot, Medium.
- Atom 120: Spot, Medium.
- Atom 200: General lighting.

Einspeisung

Das System kann mit einer nicht mitgelieferten Fernspeisung betrieben werden oder mit der Stromversorgungseinrichtung, die in die Spur eingefügt werden soll, die eine einstellbare Stromversorgung enthält. Der ursprüngliche Netzstecker verfügt über eine Lücke für die Kabeleinführung von oben und von der Seite. Der Netzstecker, die Zwischenspeiseleitung und die 90°-Ecken können nur von hinten gespeist werden. Die maximale Länge der Strecke mit demselben Treiber beträgt 10 m.

Zusatzinformationen

Zusätzliche Informationen Elektrische Anlage wird mit 24 V Gleichstrom betrieben und ist auf einen maximalen Strom von 5 A und 120 W begrenzt. Schutzgrad IP20. Auf normal entflammaren Oberflächen einsetzbar.

Qualitätszeichen

Das Gerät entspricht der europäischen technischen Norm EN60598-1 und den entsprechenden Zusatzregelungen.

Description

This new system of profiles for surface installation is characterized by its reduced dimensions, providing a minimalist aesthetic which is highly appreciated in various architectural spaces. For non-accessible ceilings, the system has integrated dimmable power supplies, controlled by 1-10V broadcast control systems. Available remote power supplies dimmable through 1/10V, DALI and Casambi Broadcast systems. Surface feeding unit available with 1/10V protocol. Casambi system available for individual bluetooth dimming of each light unit through the app FLOS Control® powered by Casambi for mobile (available on Apple Store and Google Play). The system of extruded aluminum tracks up to 3 meters in white, black, deep brown bronze and chrome. They are equipped with electric tracks supporting 24Vdc power supplies.

Optic system

- Find Me 0: Spot, Medium.
- Find Me 1: Spot, Medium.
- Find Me 2: Spot, Medium, Flood.
- Find Me 1 Suspension: Spot, Medium.
- Atom 90: Spot, Medium.
- Atom 120: Spot, Medium.
- Atom 200: General lighting.

Power Supply

The system can be powered by a remote power supply (not included) or by power supply equipments to be inserted in the track, which include a dimmable power supply. The initial power connector has a space for cable insertion through both the upper and side parts. The power connector, middle power supply and 90° corners can be powered only from the back. The maximum length of the track with the same driver is 10 meters.

Additional Information

Electrical system powered at 24Vdc and limited to a maximum current of 5A and a maximum power of 120W. IP20 protection grade. Suitable for installation on normally inflammable surfaces.

Standard Compliance and Quality Marks

EN60598-1 European Technical Standards and any subsequent additions.

FLOS
CONTROL BY CASAMBI



HOW TO ORDER

1 CHOOSE YOUR PROFILE AND LENGTH

SURFACE PROFILE



L: 1 / 2 / 3 m



2 COMPLETE WITH MOUNTING ACCESSORIES

Feed connector



Right & Left

End cap



Intermediate Feed connector



Straight

Stopper



Intermediate connector



Feed 90° Corner



Feed Inner 90° Corner



Feed T piece



Feed Cross piece



ZERO TRACK

3 SELECT POWER SUPPLY AND CONTROL OPTION

Recessed installation

remote driver

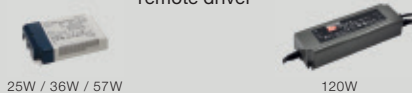

Non Dimmable / 1-10V



Dali broadcast

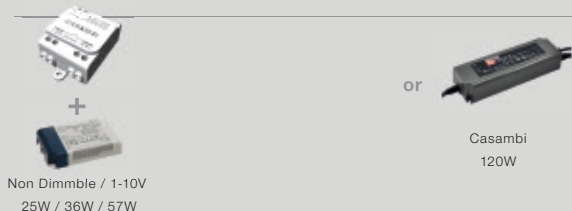

Casambi broadcast



Casambi individual

(select the driver with the appropriate power according to the needs of your project)

Surface installation

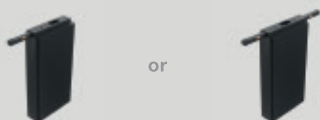

Non Dimmable / 1-10V



Casambi individual

4 SELECT A LIGHT MODULE AND CONTROL OPTION

Standard / Casambi Integrated (individual control)

Find Me 0



Atom 90



Find Me 1



Atom 120



Find Me 2



Atom 200



Find Me Suspension



ZERO TRACK SURFACE – PROFILES

Profile

Elektromechanisches Innenprofil für die Montage an der Oberfläche (Decke oder Wand) mit Schrauben, die mit dem Profil versehenen speziellen Bolzen befestigt werden. Mit Längen von 1 bis 3 m.
 Notwendig, um Stromstecker, Zwischenstecker und Abdeckungen separat zu bestellen.
 Mechanische 90°-Ecken verfügbar mit Krümmung auf derselben Ebene (symmetrisches Element für die linke und rechte Ecke) und 90°-Eck auf verschiedenen Ebenen (Decke-Wand und Wand-Innenwand), sowie "T"- und "X"-Verbindungen.
 Bei vertikalen Installationen muss der Stopper installiert werden, der separat bestellt werden muss.

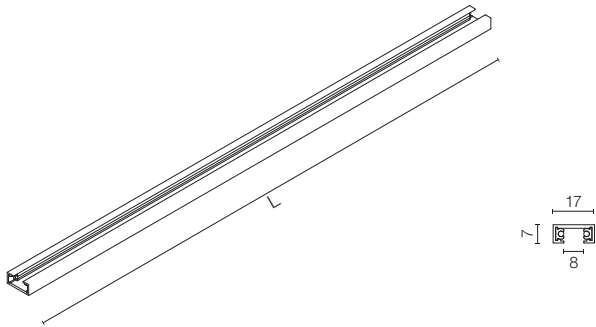

L: 1 m / 2 m / 3 m

Profiles

Electro-mechanical indoor profile for surface installation (ceiling or wall). To be fixed with specific screw plugs that come with the profile. 1-meter to 3-meters lengths.
 It is necessary to order the power connector, intermediate connectors and covers separately.
 Feed unit connectors available as 90° flat corner and curve (symmetric element for left/right corner), ceiling/wall - wall/wall inner corner, as well as "T" and "X" shape.
 For vertical installations, installing the stopper is mandatory. It must be ordered separately.

- L: 1000 mm
- 06.2500.40
 - 06.2500.06
 - 06.2500.14
 - 06.2500.CZ
 - 06.2500.18
- L: 2000 mm
- 06.2501.40
 - 06.2501.06
 - 06.2501.14
 - 06.2501.CZ
 - 06.2501.18
- L: 3000 mm
- 06.2502.40
 - 06.2502.06
 - 06.2502.14
 - 06.2502.CZ
 - 06.2502.18

Stromanschluss für Fernsteuergeräte. Möglicher Eingang des Stromkabels sowohl oben als auch seitlich.

Feed unit for remote power supply unit. Power cable inserting is possible both from the top and the side.

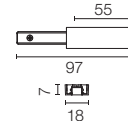

- 06.2540.40
- 06.2540.14
- 06.2540.CZ
- 06.2540.18

Zwischenstecker. Oberer Netzkabeleingang.

Feed intermediate connector. Upper feeding cable entry.

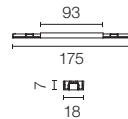

- 06.2541.40
- 06.2541.14
- 06.2541.CZ
- 06.2541.18

Außenwinkel.

Intermediate connector.

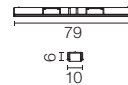

- 06.2506.40
- 06.2506.14

90° flache Ecke. Auf der Rückseite befindet sich ein Versorgungsanschluss.

90° flat corner. Can be powered. It has a rear space for the supply connection.

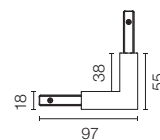

- 06.2542.40
- 06.2542.14
- 06.2542.CZ
- 06.2542.18

Innenecke Decke / Wand - Wand / Wand. Mit Strom versorgbar, mit zwei Reserven auf beiden Seiten der Rückseite.

Ceiling/wall - wall/wall inner corner. Can be powered. It has two spaces for the supply connection located on each side at the rear.

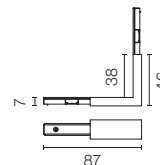

- 06.2543.40
- 06.2543.14
- 06.2543.CZ
- 06.2543.18

Innenkurve Decke/Decke – Wand/ Wand. Stromversorgungsfähig, mit Anschluss auf der Rückseite.

Interior ceiling/ceiling-wall/ wall curve. Can be powered via connections on the back.

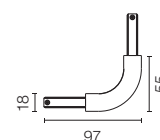

- 06.2544.40
- 06.2544.14
- 06.2544.CZ
- 06.2544.18

ZERO TRACK SURFACE – PROFILES

T-Anschluss. Einspeisung mit Anschluss auf der Rückseite.

T-shaped connector. Can be powered via connections on the back.

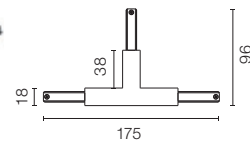

06.2545.40
06.2545.14
06.2545.CZ
06.2545.18

Kreuzförmiger Anschluss. Stromversorgungsfähig, mit Anschluss auf der Rückseite.

Cross-shaped connector. Can be powered via connections on the back.

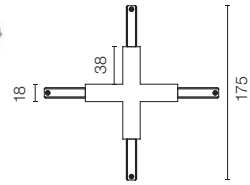

06.2546.40
06.2546.14
06.2546.CZ
06.2546.18

Endkappe.

End cap.



06.2509.40
06.2509.14
06.2509.CZ
06.2509.18

Stopper. Zur Befestigung von Leuchten in vertikalen Schieneninstallationen.

Stopper. For fixing luminaires in vertical track installations.



08.0630.40
08.0630.14

ZERO TRACK – LIGHT MODULES

Find Me 0 Designed By Jorge Herrera

Light Source: Power LED 3,5W - 300 lm - 2700K/CRI 90 / 3,5W - 325 lm - 3000K/CRI 90

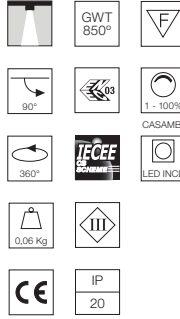
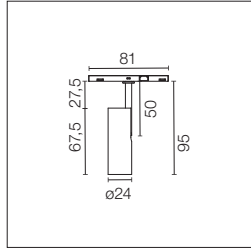

LED-Akzentbeleuchtungsmodul zum Einbau in das Zero Track-System.

Integrierter elektronischer Leistungswandler DC/DC. Modul geregelt durch 1-10V-Treiber, DALI oder Casambi, Broadcast-Modus. Dimmer nicht enthalten.

Für die individuelle Steuerung der Leuchten sind die integrierten Casambi-Versionen auszuwählen. Inkludiertes Zubehör (Honeycomb und Blendschutzgitter).

LED accent lighting module to be installed in the Zero Track system. Incorporated DC/DC electronic converter. Module regulated via 1-10-V DALI or Casambi driver in broadcast mode. Dimmer not included.

To individually control the lights, select integrated Casambi versions. Accessories included (honeycomb and screening crosspiece).

- 2700K**
- 09.3801.40A
 - 09.3801.06A
 - 09.3801.14A
 - 09.3801.CZA
 - 09.3801.18A
- **Casambi integrated
- 09.3901.40A
 - 09.3901.06A
 - 09.3901.14A
 - 09.3901.CZA
 - 09.3901.18A

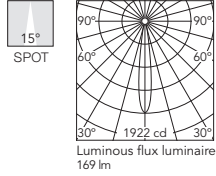

Beam Angle: 15°

h(m)	E(lx)	D(m)
1	1922	0.26
2	481	0.52
3	214	0.77
4	120	1.03
5	77	1.29

- 3000K**
- 09.3800.40A
 - 09.3800.06A
 - 09.3800.14A
 - 09.3800.CZA
 - 09.3800.18A
- **Casambi integrated
- 09.3900.40A
 - 09.3900.06A
 - 09.3900.14A
 - 09.3900.CZA
 - 09.3900.18A

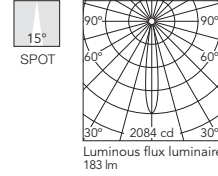

Beam Angle: 15°

h(m)	E(lx)	D(m)
1	2084	0.26
2	521	0.52
3	232	0.77
4	130	1.03
5	83	1.29

- 2700K**
- 09.3803.40A
 - 09.3803.06A
 - 09.3803.14A
 - 09.3803.CZA
 - 09.3803.18A
- **Casambi integrated
- 09.3903.40A
 - 09.3903.06A
 - 09.3903.14A
 - 09.3903.CZA
 - 09.3903.18A

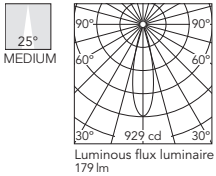

Beam Angle: 25°

h(m)	E(lx)	D(m)
1	929	0.45
2	232	0.89
3	103	1.34
4	58	1.79
5	37	2.23

- 3000K**
- 09.3802.40A
 - 09.3802.06A
 - 09.3802.14A
 - 09.3802.CZA
 - 09.3802.18A
- **Casambi integrated
- 09.3902.40A
 - 09.3902.06A
 - 09.3902.14A
 - 09.3902.CZA
 - 09.3902.18A

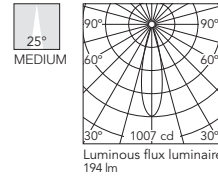

Beam Angle: 25°

h(m)	E(lx)	D(m)
1	1007	0.45
2	252	0.89
3	112	1.34
4	63	1.79
5	40	2.23

** Die Steuerung bei den Casambi-Leuchten erfolgt direkt und individuell kabellos mittels App FLOS Control® powered by Casambi. Die restlichen Steuervorgänge erfolgen per Broadcast (alle Leuchten werden gleichzeitig gesteuert) / The control system with the Casambi version of light fixtures is directly and individually regulated wirelessly using the application FLOS Control® powered by Casambi. Other types of regulation are broadcast (all lights are regulated at the same time).

ZERO TRACK – LIGHT MODULES

Find Me 1 Designed By Jorge Herrera

Light Source: Power LED 5,5W - 450 lm - 2700K/CRI 90 / 5,5W - 485 lm - 3000K/CRI 90

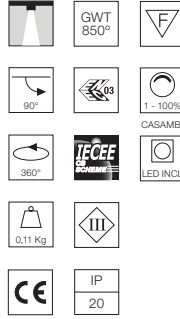
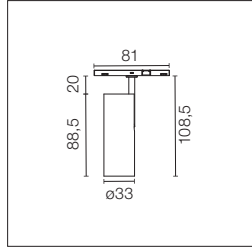

LED-Akzentbeleuchtungsmodul zum Einbau in das Zero Track-System.
 Integrierter elektronischer Leistungswandler DC/DC. Modul geregelt durch 1-10V-Treiber, DALI oder Casambi, Broadcast-Modus. Dimmer nicht enthalten.
 Für die individuelle Steuerung der Leuchten sind die integrierten Casambi-Versionen auszuwählen. Inkludiertes Zubehör (Honeycomb und Blendschutzgitter).

LED accent lighting module to be installed in the Zero Track system. Incorporated DC/DC electronic converter. Module regulated via 1-10-V DALI or Casambi driver in broadcast mode. Dimmer not included.
 To individually control the lights, select integrated Casambi versions. Accessories included (honeycomb and screening crosspiece).

- 2700K**
- 09.3812.40A
 - 09.3812.06A
 - 09.3812.14A
 - 09.3812.CZA
 - 09.3812.18A
- **Casambi integrated
- 09.3912.40A
 - 09.3912.06A
 - 09.3912.14A
 - 09.3912.CZA
 - 09.3912.18A

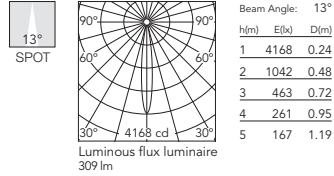

- 3000K**
- 09.3810.40A
 - 09.3810.06A
 - 09.3810.14A
 - 09.3810.CZA
 - 09.3810.18A
- **Casambi integrated
- 09.3910.40A
 - 09.3910.06A
 - 09.3910.14A
 - 09.3910.CZA
 - 09.3910.18A

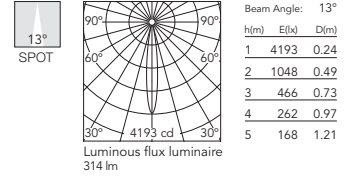

- 2700K**
- 09.3813.40A
 - 09.3813.06A
 - 09.3813.14A
 - 09.3813.CZA
 - 09.3813.18A
- **Casambi integrated
- 09.3913.40A
 - 09.3913.06A
 - 09.3913.14A
 - 09.3913.CZA
 - 09.3913.18A

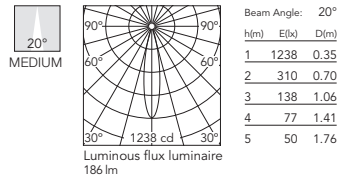

- 3000K**
- 09.3811.40A
 - 09.3811.06A
 - 09.3811.14A
 - 09.3811.CZA
 - 09.3811.18A
- **Casambi integrated
- 09.3911.40A
 - 09.3911.06A
 - 09.3911.14A
 - 09.3911.CZA
 - 09.3911.18A

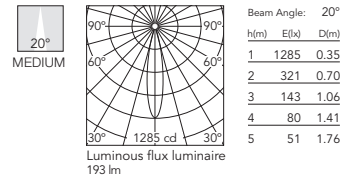

** Die Steuerung bei den Casambi-Leuchten erfolgt direkt und individuell kabellos mittels App FLOS Control® powered by Casambi. Die restlichen Steuervorgänge erfolgen per Broadcast (alle Leuchten werden gleichzeitig gesteuert) / The control system with the Casambi version of light fixtures is directly and individually regulated wirelessly using the application FLOS Control® powered by Casambi. Other types of regulation are broadcast (all lights are regulated at the same time).

ZERO TRACK – LIGHT MODULES

Find Me 2 Designed By Jorge Herrera

Light Source: Power LED 10,5W* - 650 lm - 2700K/CRI90 / 10,5W* - 700 lm - 3000K/CRI90

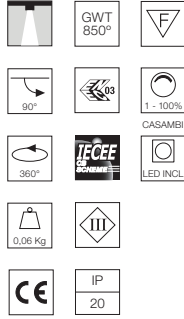
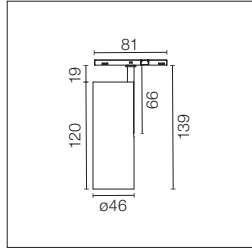

LED-Akzentbeleuchtungsmodul zum Einbau in das Zero Track-System.

Integrierter elektronischer Leistungswandler DC/DC. Modul geregelt durch 1-10V-Treiber, DALI oder Casambi, Broadcast-Modus. Dimmer nicht enthalten.

Für die individuelle Steuerung der Leuchten sind die integrierten Casambi-Versionen auszuwählen. Inkludiertes Zubehör (Honeycomb und Blendschutzgitter).

LED accent lighting module to be installed in the Zero Track system. Incorporated DC/DC electronic converter. Module regulated via 1-10-V DALI or Casambi driver in broadcast mode. Dimmer not included.

To individually control the lights, select integrated Casambi versions. Accessories included (honeycomb and screening crosspiece).

- 2700K**
- 09.3862.40A
 - 09.3862.06A*
 - 09.3862.14A
 - 09.3862.CZA
 - 09.3862.18A
- **Casambi integrated
- 09.3962.40A
 - 09.3962.06A*
 - 09.3962.14A
 - 09.3962.CZA
 - 09.3962.18A

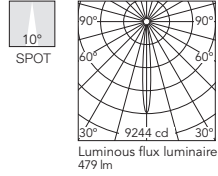

Beam Angle: 10°

h(m)	E(lx)	D(m)
1	9244	0.18
2	2311	0.35
3	1027	0.53
4	578	0.70
5	370	0.88

- 3000K**
- 09.3860.40A
 - 09.3860.06A*
 - 09.3860.14A
 - 09.3860.CZA
 - 09.3860.18A
- **Casambi integrated
- 09.3960.40A
 - 09.3960.06A*
 - 09.3960.14A
 - 09.3960.CZA
 - 09.3960.18A

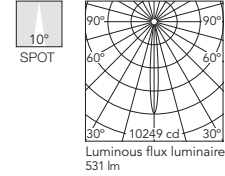

Beam Angle: 10°

h(m)	E(lx)	D(m)
1	10249	0.18
2	2562	0.35
3	1139	0.53
4	641	0.70
5	410	0.88

- 2700K**
- 09.3863.40A
 - 09.3863.06A*
 - 09.3863.14A
 - 09.3863.CZA
 - 09.3863.18A
- **Casambi integrated
- 09.3963.40A
 - 09.3963.06A*
 - 09.3963.14A
 - 09.3963.CZA
 - 09.3963.18A

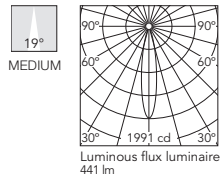

Beam Angle: 19°

h(m)	E(lx)	D(m)
1	1991	0.34
2	498	0.67
3	221	1.01
4	124	1.34
5	80	1.68

- 3000K**
- 09.3861.40A
 - 09.3861.06A*
 - 09.3861.14A
 - 09.3861.CZA
 - 09.3861.18A
- **Casambi integrated
- 09.3961.40A
 - 09.3961.06A*
 - 09.3961.14A
 - 09.3961.CZA
 - 09.3961.18A

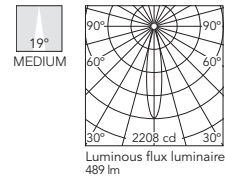

Beam Angle: 19°

h(m)	E(lx)	D(m)
1	2208	0.34
2	552	0.67
3	245	1.01
4	138	1.34
5	88	1.68

- 2700K**
- 09.3865.40A
 - 09.3865.06A*
 - 09.3865.14A
 - 09.3865.CZA
 - 09.3865.18A
- **Casambi integrated
- 09.3965.40A
 - 09.3965.06A*
 - 09.3965.14A
 - 09.3965.CZA
 - 09.3965.18A

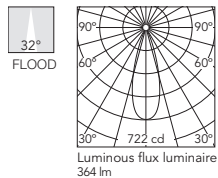

Beam Angle: 32°

h(m)	E(lx)	D(m)
1	722	0.57
2	180	1.15
3	80	1.72
4	45	2.29
5	29	2.87

- 3000K**
- 09.3864.40A
 - 09.3864.06A*
 - 09.3864.14A
 - 09.3864.CZA
 - 09.3864.18A
- **Casambi integrated
- 09.3964.40A
 - 09.3964.06A*
 - 09.3964.14A
 - 09.3964.CZA
 - 09.3964.18A

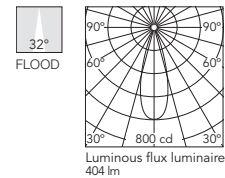

Beam Angle: 32°

h(m)	E(lx)	D(m)
1	800	0.57
2	200	1.15
3	89	1.72
4	50	2.29
5	32	2.87

* Für Chromoberflächen beträgt ihre Leistung 8W. / For chrome finishes their power is 8W.

** Die Steuerung bei den Casambi-Leuchten erfolgt direkt und individuell kabellos mittels App FLOS Control® powered by Casambi. Die restlichen Steuervorgänge erfolgen per Broadcast (alle Leuchten werden gleichzeitig gesteuert) / The control system with the Casambi version of light fixtures is directly and individually regulated wirelessly using the application FLOS Control® powered by Casambi. Other types of regulation are broadcast (all lights are regulated at the same time).

ZERO TRACK – LIGHT MODULES

Find Me 1 Suspension Designed By Jorge Herrera

Light Source: Power LED 5,5W - 450 lm - 2700K/CRI 90 / 5,5W - 485 lm - 3000K/CRI 90

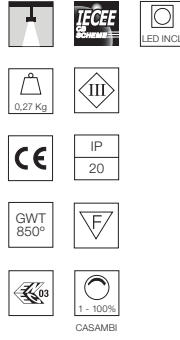
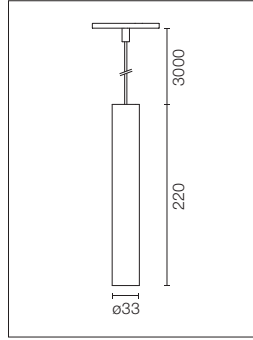

LED-Akzentbeleuchtungsmodul zum Einbau in das Zero Track-System. Integrierter elektronischer Leistungswandler DC/DC. Modul geregelt durch 1-10V-Treiber, DALI oder Casambi, Broadcast-Modus. Dimmer nicht enthalten. Für die individuelle Steuerung der Leuchten sind die integrierten Casambi-Versionen auszuwählen. Nicht auf vertikalen Schienen montierbar. Inkludiertes Zubehör (Honeycomb und Blendschutzgitter).

LED accent lighting module to be installed in the Zero Track system. Incorporated DC/DC electronic converter. Module regulated via 1-10-V DALI or Casambi driver in broadcast mode. Dimmer not included. To individually control the lights, select integrated Casambi versions. Not suitable for vertical installations. Accessories included (honeycomb and screening crosspiece).

- 2700K**
- 09.3822.40A
 - 09.3822.06A
 - 09.3822.14A
 - 09.3822.CZA
 - 09.3822.18A
- **Casambi integrated
- 09.3922.40A
 - 09.3922.06A
 - 09.3922.14A
 - 09.3922.CZA
 - 09.3922.18A

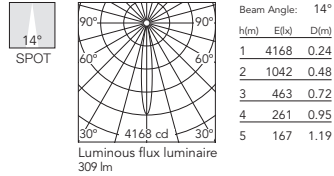

- 3000K**
- 09.3820.40A
 - 09.3820.06A
 - 09.3820.14A
 - 09.3820.CZA
 - 09.3820.18A
- **Casambi integrated
- 09.3920.40A
 - 09.3920.06A
 - 09.3920.14A
 - 09.3920.CZA
 - 09.3920.18A

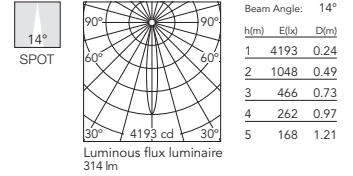

- 2700K**
- 09.3823.40A
 - 09.3823.06A
 - 09.3823.14A
 - 09.3823.CZA
 - 09.3823.18A
- **Casambi integrated
- 09.3923.40A
 - 09.3923.06A
 - 09.3923.14A
 - 09.3923.CZA
 - 09.3923.18A

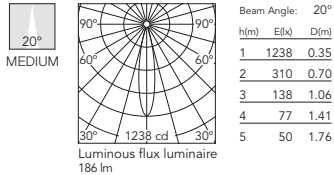

- 3000K**
- 09.3821.40A
 - 09.3821.06A
 - 09.3821.14A
 - 09.3821.CZA
 - 09.3821.18A
- **Casambi integrated
- 09.3921.40A
 - 09.3921.06A
 - 09.3921.14A
 - 09.3921.CZA
 - 09.3921.18A

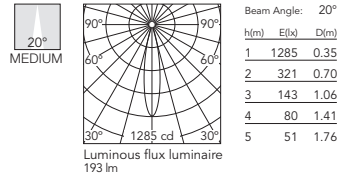

** Die Steuerung bei den Casambi-Leuchten erfolgt direkt und individuell kabellos mittels App FLOS Control® powered by Casambi. Die restlichen Steuervorgänge erfolgen per Broadcast (alle Leuchten werden gleichzeitig gesteuert) / The control system with the Casambi version of light fixtures is directly and individually regulated wirelessly using the application FLOS Control® powered by Casambi. Other types of regulation are broadcast (all lights are regulated at the same time).

ZERO TRACK – LIGHT MODULES

Atom 90 Designed By Piero Lissoni

Light Source: Power LED 5,5W* - 450 lm - 2700K/CRI 90 / 5,5W* - 485 lm - 3000K/CRI 90

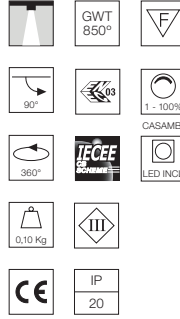
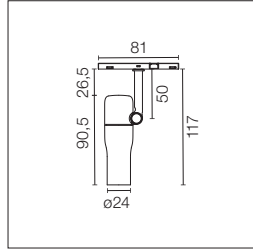

LED-Akzentbeleuchtungsmodul zum Einbau in das Zero Track-System.
 Integrierter elektronischer Leistungswandler DC/DC. Modul geregelt durch 1-10V-Treiber, DALI oder Casambi, Broadcast-Modus. Dimmer nicht enthalten.
 Für die individuelle Steuerung der Leuchten sind die integrierten Casambi-Versionen auszuwählen. Inkludiertes Zubehör (Honeycomb und Blendschutzgitter).

LED accent lighting module to be installed in the Zero Track system. Incorporated DC/DC electronic converter. Module regulated via 1-10-V DALI or Casambi driver in broadcast mode. Dimmer not included.
 To individually control the lights, select integrated Casambi versions. Accessories included (honeycomb and screening crosspiece).

- 2700K**
- 09.3831.40A
 - 09.3831.06A*
 - 09.3831.14A
 - 09.3831.CZA
 - 09.3831.18A
- **Casambi integrated
- 09.3931.40A
 - 09.3931.06A*
 - 09.3931.14A
 - 09.3931.CZA
 - 09.3931.18A

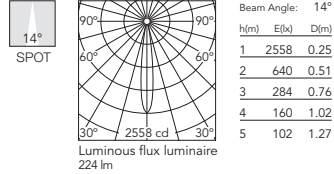

- 3000K**
- 09.3830.40A
 - 09.3830.06A*
 - 09.3830.14A
 - 09.3830.CZA
 - 09.3830.18A
- **Casambi integrated
- 09.3930.40A
 - 09.3930.06A*
 - 09.3930.14A
 - 09.3930.CZA
 - 09.3930.18A

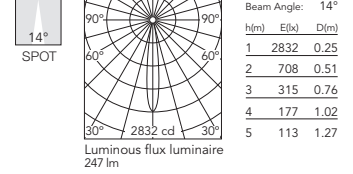

- 2700K**
- 09.3833.40A
 - 09.3833.06A*
 - 09.3833.14A
 - 09.3833.CZA
 - 09.3833.18A
- **Casambi integrated
- 09.3933.40A
 - 09.3933.06A*
 - 09.3933.14A
 - 09.3933.CZA
 - 09.3933.18A

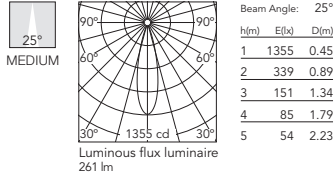

- 3000K**
- 09.3832.40A
 - 09.3832.06A*
 - 09.3832.14A
 - 09.3832.CZA
 - 09.3832.18A
- **Casambi integrated
- 09.3932.40A
 - 09.3932.06A*
 - 09.3932.14A
 - 09.3932.CZA
 - 09.3932.18A

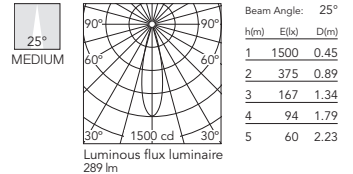

* Für Chromoberflächen beträgt ihre Leistung 4,7 W. / For chrome finishes their power is 4.7W.

** Die Steuerung bei den Casambi-Leuchten erfolgt direkt und individuell kabellos mittels App FLOS Control® powered by Casambi. Die restlichen Steuervorgänge erfolgen per Broadcast (alle Leuchten werden gleichzeitig gesteuert) / The control system with the Casambi version of light fixtures is directly and individually regulated wirelessly using the application FLOS Control® powered by Casambi. Other types of regulation are broadcast (all lights are regulated at the same time).

ZERO TRACK – LIGHT MODULES

Atom 120 Designed By Piero Lissoni

Light Source: Power LED 8W* - 635 lm - 2700K/CRI 90 / 8W* - 680 lm - 3000K/CRI 90

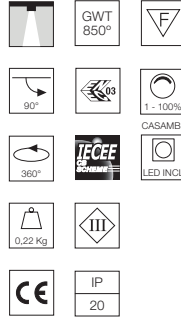
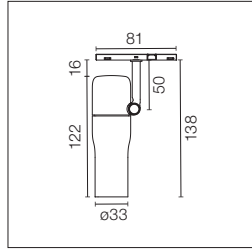

LED-Akzentbeleuchtungsmodul zum Einbau in das Zero Track-System.
Integrierter elektronischer Leistungswandler DC/DC. Modul geregelt durch 1-10V-Treiber, DALI oder Casambi, Broadcast-Modus. Dimmer nicht enthalten.
Für die individuelle Steuerung der Leuchten sind die integrierten Casambi-Versionen auszuwählen. Inkludiertes Zubehör (Honeycomb und Blendschutzgitter).

LED accent lighting module to be installed in the Zero Track system. Incorporated DC/DC electronic converter. Module regulated via 1-10-V DALI or Casambi driver in broadcast mode. Dimmer not included.
To individually control the lights, select integrated Casambi versions. Accessories included (honeycomb and screening crosspiece).

- 2700K**
- 09.3841.40A
 - 09.3841.06A*
 - 09.3841.14A
 - 09.3841.CZA
 - 09.3841.18A
- **Casambi integrated
- 09.3941.40A
 - 09.3941.06A*
 - 09.3941.14A
 - 09.3941.CZA
 - 09.3941.18A

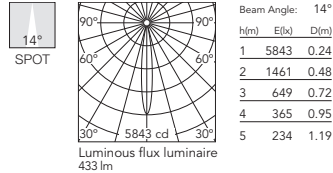

- 3000K**
- 09.3840.40A
 - 09.3840.06A*
 - 09.3840.14A
 - 09.3840.CZA
 - 09.3840.18A
- **Casambi integrated
- 09.3940.40A
 - 09.3940.06A*
 - 09.3940.14A
 - 09.3940.CZA
 - 09.3940.18A

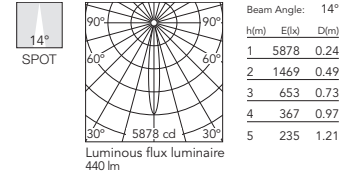

- 2700K**
- 09.3843.40A
 - 09.3843.06A*
 - 09.3843.14A
 - 09.3843.CZA
 - 09.3843.18A
- **Casambi integrated
- 09.3943.40A
 - 09.3943.06A*
 - 09.3943.14A
 - 09.3943.CZA
 - 09.3943.18A

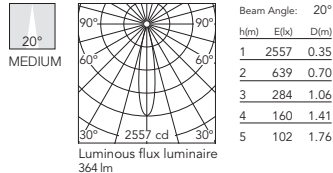

- 3000K**
- 09.3842.40A
 - 09.3842.06A*
 - 09.3842.14A
 - 09.3842.CZA
 - 09.3842.18A
- **Casambi integrated
- 09.3942.40A
 - 09.3942.06A*
 - 09.3942.14A
 - 09.3942.CZA
 - 09.3942.18A

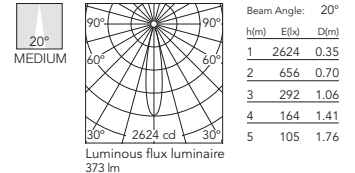

Atom 200 Designed By Piero Lissoni

Light Source: Power LED 10,5W - 1050 lm - 2700K/CRI 90 / 10,5W - 1150 lm - 3000K/CRI 90

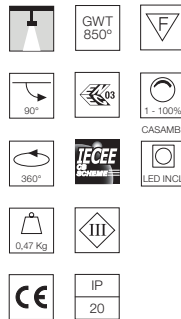
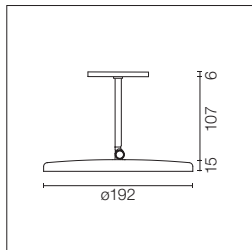

Allgemeines LED-Beleuchtungsmodul zum Einbau in das Zero Track-System. Integrierter elektronischer Leistungswandler DC/DC. Modul geregelt durch 1-10V-Treiber, DALI oder Casambi, Broadcast-Modus. Dimmer nicht enthalten.
Für die individuelle Steuerung der Leuchten sind die integrierten Casambi-Versionen auszuwählen. Nicht auf vertikalen Schienen montierbar.

LED general lighting module to be installed in the Zero Track system. Incorporated DC/DC electronic converter. Module regulated via 1-10-V DALI or Casambi driver in broadcast mode. Dimmer not included.
To individually control the lights, select integrated Casambi versions. Not suitable for vertical installations.

- 2700K**
- 09.3851.40
 - 09.3851.06
 - 09.3851.14
 - 09.3851.CZ
 - 09.3851.18
- **Casambi integrated
- 09.3951.40
 - 09.3951.06
 - 09.3951.14
 - 09.3951.CZ
 - 09.3951.18

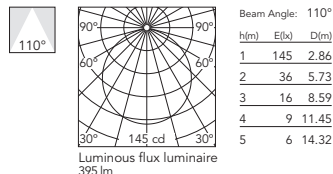

- 3000K**
- 09.3850.40
 - 09.3850.06
 - 09.3850.14
 - 09.3850.CZ
 - 09.3850.18
- **Casambi integrated
- 09.3950.40
 - 09.3950.06
 - 09.3950.14
 - 09.3950.CZ
 - 09.3950.18

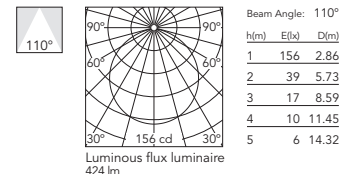

* Für Chromoberflächen beträgt ihre Leistung 6W. / For chrome finishes their power is 6W.

** Die Steuerung bei den Casambi-Leuchten erfolgt direkt und individuell kabellos mittels App FLOS Control® powered by Casambi. Die restlichen Steuervorgänge erfolgen per Broadcast (alle Leuchten werden gleichzeitig gesteuert) / The control system with the Casambi version of light fixtures is directly and individually regulated wirelessly using the application FLOS Control® powered by Casambi. Other types of regulation are broadcast (all lights are regulated at the same time).

ZERO TRACK

Treiber / Drivers

1-10V Broadcast / Non Dimmable

Surface Installation

Endstromversorgung für die Oberflächeninstallation. Dimmbar durch 1 / 10V Protokoll oder No Dimable. Es kann nicht auf Wandschienen installiert werden. Dimmbereich 100-20 %.

Power supply surface end. Dimmable through 1/10V protocol or Non Dimmable. Cannot be installed on wall tracks. Dimming range 20-100%.

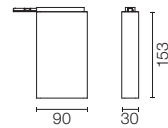

57W - 220/240V
06.2510.40
06.2510.06
06.2510.14
06.2510.CZ
06.2510.18

Zwischenstromversorgung für die Oberflächenmontage. Dimmbar durch 1 / 10V Protokoll oder No Dimable. Es kann nicht auf Wandschienen installiert werden. Dimmbereich 100-20 %.

Power supply surface middle. Dimmable through 1/10V protocol or Non Dimmable. Cannot be installed on wall tracks. Dimming range 20-100%.

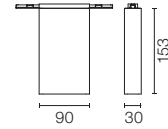

57W - 220/240V
06.2511.40
06.2511.06
06.2511.14
06.2511.CZ
06.2511.18

Non Dimmable

Remote Installation

Fernspeisung. No Dimable. 220/240V.

Remote power supply. Non Dimmable. 220/240V.

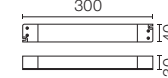

120W - 220/240V
60.9516

1-10V Broadcast / Non Dimmable

Remote Installation

Fernspeisung. Dimmbar durch 1 / 10V Protokoll oder No Dimable. Dimmbereich 100-20 %.

Remote power supply. Dimmable through 1/10V protocol or Non Dimmable. Dimming range 20-100%.

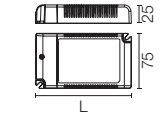

25W - 110/240V - L:110
60.9359
36W-110V / 45W-240V - L:120
60.9360
57W - 220/240V - L:130
60.9361

Fernspeisung. Dimmbar durch 1/10V -Protokoll oder No Dimable. Dimmbereich 10-100 %. Mindestlast 20W

Remote power supply. Dimmable through 1/10V protocol or Non Dimmable. Dimming range 10-100%. Minimum load 20W

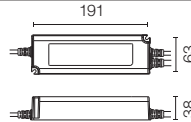

120W - 110*/240V
60.9681

*UL max 100W

DALI

Remote Installation

Fernspeisung. Dimmbar durch DALI2-Protokoll. Dimmbereich 10-100 %. Mindestlast 20W

Remote power supply. Dimmable through DALI 2 protocol. Dimming range 10-100%. Minimum load 20W

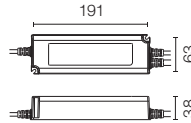

120W - 110*/240V
60.9682

*UL max 100W

Casambi

Remote Installation

Fernspeisung. Dimmbar durch Casambi-Protokoll. 24V. Dimmbereich 10-100 %. Mindestlast 20W

Remote power supply. Dimmable through Casambi protocol. 24V. Dimming range 10-100%.

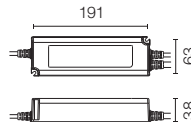

120W - 110*/240V
60.9683

*UL max 100W

Kontroller Casambi 220-240V. Benötigt 1-10V oder Dali-Treiber, separat bestellen. Nur mit 60.9359-60.9360-60.9361 verwenden. Dimmbereich 20-100 %.

Casambi controller 220-240V. Requires 1-10V or Dali driver. It must be ordered separately. Use only with 60.9359-60.9360-60.9361 Dimming range 20-100%.

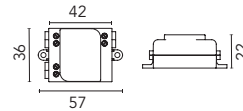

60.9392

Track Length (m)	% Driver Nominal Power
1	95
2	95
3	95
4	95
5	95
6	93
7	91
8	89
9	87
10	85

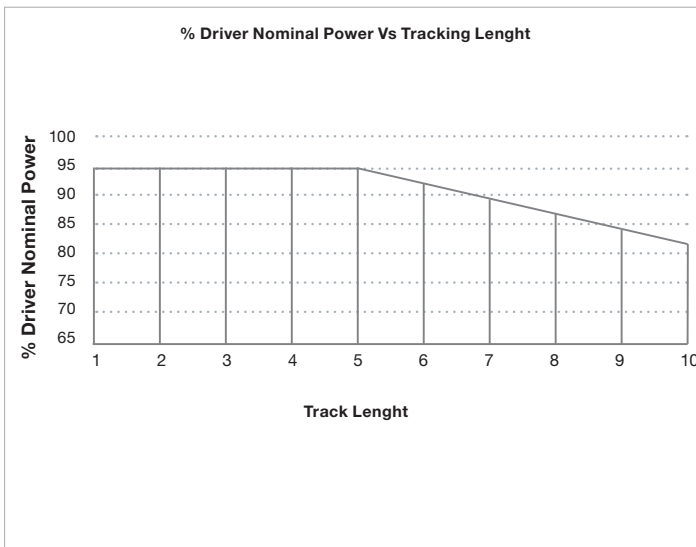

Example:

Ref. 60.9361: 57W / 4 m track
57W x 0,95 = 54,15W available

	W luminary	N° luminaries	W luminaries
Find Me 0	3,5	3	10,5
Find Me 1	5,5	0	0
Find Me 2	10,5	0	0
Atom 90	5,5	3	16,5
Atom 120	8	2	16
Atom 200	10,5	1	10,5
Total system power: 53,5W			

ZERO TRACK - REGULATION SYSTEMS

Remote Driver Installations - Broadcast

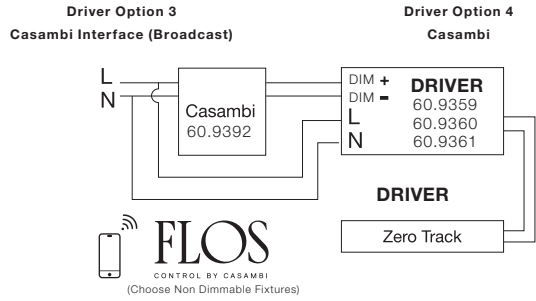
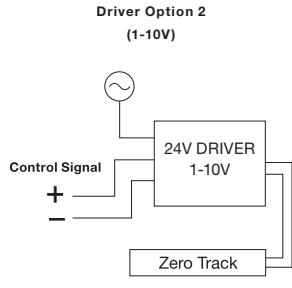
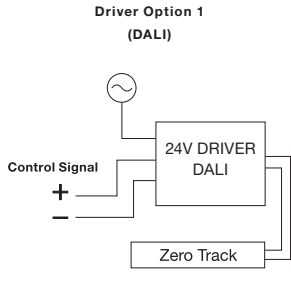
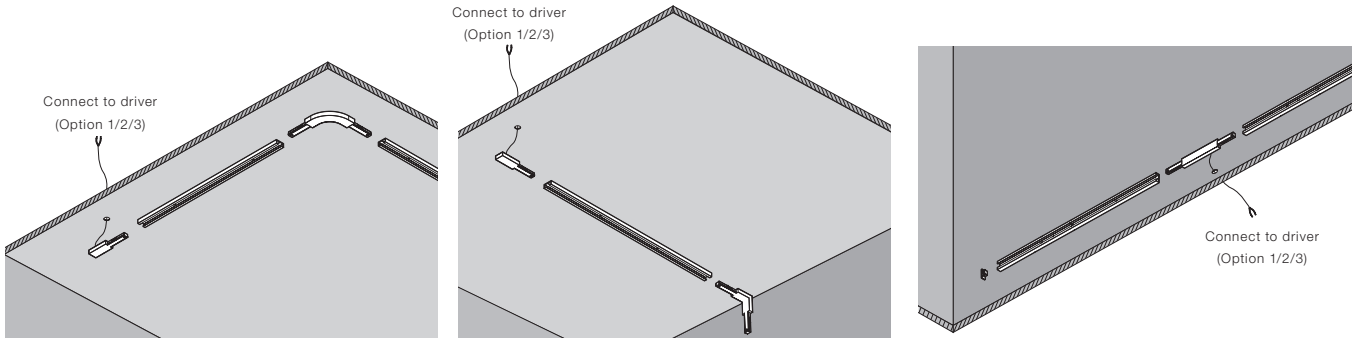

Surface Driver Installations - Broadcast

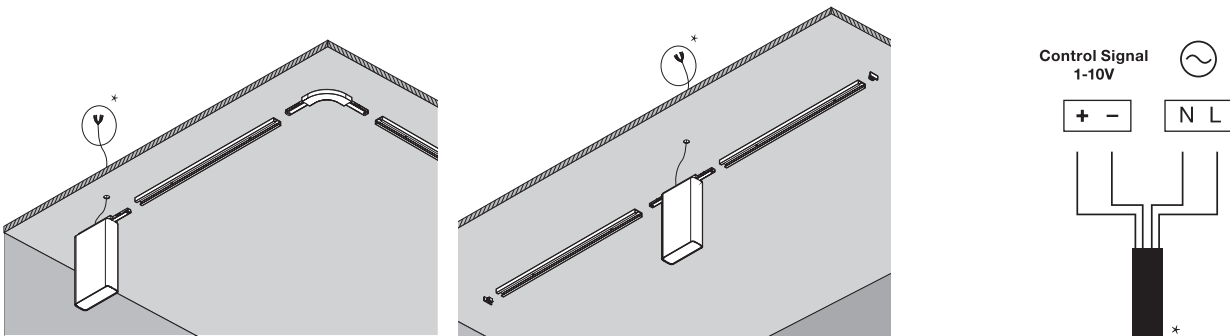

Individual Control Casambi Bluetooth

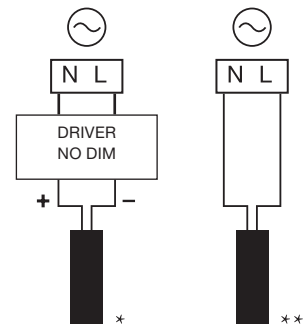
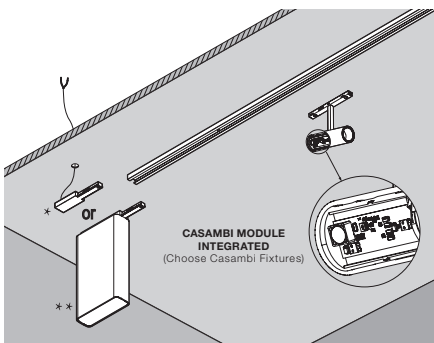

THE MICRO RUNNING MAGNET

DESIGNED BY FLOS ARCHITECTURAL

RECESSED

SURFACE



Recessed Profiles 14 Schwarz
 14 Black

Surface Profiles 40 Weiss
 40 White 14 Schwarz
 14 Black

LIGHT MODULES

NANO SPOT



LIGHT SOURCE
 POWER LED
 2W
 165 lm
 2700K/CRI 90
 170 lm
 3000K/CRI 90
 185 lm
 4000K/CRI 90
 200 lm
 5000K/CRI 90

MICRO SPOT



LIGHT SOURCE
 POWER LED
 3W
 275 lm
 2700K/CRI 90
 295 lm
 3000K/CRI 90
 315 lm
 4000K/CRI 90
 335 lm
 5000K/CRI 90

SPOT



LIGHT SOURCE
 POWER LED
 6W
 545 lm
 2700K/CRI 90
 585 lm
 3000K/CRI 90
 625 lm
 4000K/CRI 90
 665 lm
 5000K/CRI 90

LIGHT SHADOW SPOT



LIGHT SOURCE
 POWER LED
 3W
 270 lm
 2700K/CRI 90
 285 lm
 3000K/CRI 90
 300 lm
 4000K/CRI 90
 320 lm
 5000K/CRI 90

LIGHT STRIPE DIFFUSED



LIGHT STRIPE WALL-WASHER



LIGHT SOURCE
 TOP LED
 15W/m
 1440 lm/m
 2700K/CRI 90
 1550 lm/m
 3000K/CRI 90
 1660 lm
 4000K/CRI 90
 1775 lm
 5000K/CRI 90

THE MICRO RUNNING MAGNET

Produktbeschreibung

Innovatives Programm ultra-miniaturisierter Strukturen in Einbau- oder Aufputzversionen. Dank einer magnetischen Befestigung mit einer Vielzahl an professionellen Beleuchtungslösungen kompatibel. Der Micro Running Magnet ist die ultimative Lösung zur Beleuchtung von Ausstellungen. Ein umfassendes und professionelles Programm, das neben geringen Abmessungen ein ausbalanciertes und attraktives Licht bietet, um jedes Objekt in 360° optimal hervorzuheben.

Die Quintessenz des integrierten Lichts, das dank eines nur 5 mm breiten Profils erzielt wird und das die vollständige Einbindung der Mikrovorrichtungen ermöglicht, die entworfen wurden, um mit der Struktur kombiniert zu werden, bis sie nahezu komplett verschwinden.

Die unglaublich geringe Größe des Profils, welches das Programm kennzeichnet, erhöht die Flexibilität des Lichts und unterstreicht seine Beziehung zur Architektur. Die Installation der Leuchtkörper erfolgt mittels einer Magnethalterung innerhalb des Profils für eine unübertroffene Benutzerfreundlichkeit.

Magnetische Befestigung der Leuchten, die auch eine Handhabung in heißem Zustand ermöglicht. Die Leuchtkörper können in eingeschaltetem Zustand bewegt werden, sodass jederzeit eine größere Flexibilität und Anpassungsfähigkeit der Konfiguration zu erzielen ist.

Sämtliche Konstruktionsprofile von Micro Running Magnet bestehen aus extrudiertem Aluminium in Schwarz und Weiß und sind mit elektrischen Schienen ausgestattet, die mit 24 V versorgt werden, auf denen die LED-Leuchten über ein magnetisches Befestigungssystem angebracht werden.

Komplettes Sortiment von Mikro-Projektoren, die mit unterschiedlicher Leistung und in verschiedenen Größen erhältlich sind. Sie alle enthalten professionell stabilisierte Mikrolinsen aus Acryl für eine maximale Kontrolle über die Leuchteffekte.

Steuerung

- DALI: Broadcast-Steuerung, alle Leuchten gleichzeitig.
- 1-10V: Broadcast-Fernsteuerung (Dimmen aller Leuchten einer Gruppe).
- CASAMBI: Broadcast-Steuerung mittels App für Tablet oder Smartphone (FLOS Control®).

Für Mobilgeräte ist eine APP erforderlich (erhältlich im Apple Store und auf Google Play).

Optisches System

Das Akzentbeleuchtungsmodul ist mit intensiver (spot lens) und extensiver Optik (medium, flood und wide flood) erhältlich. Das lineare Beleuchtungsmodul mit direktem Licht für die Allgemein- und Wandbeleuchtung in unterschiedlichen Längen zwischen 300 mm und 1200 mm.

Einspeisung

Fern-Netzteil 24V nicht enthalten.

Zusatzinformationen

Der Micro Running Magnet ist ein mit 24 V gespeistes elektrisches System, das auf eine maximale Stromstärke von 5 A und 120 W begrenzt ist, um Überlastungen zu verhindern. Jedes Mal, wenn 120 W erreicht werden, muss die Verbindung über ein Einspeisungsprofil erneut erfolgen.

Schutzgrad IP20.

Auf normal entflammbar Oberflächen einsetzbar.

Empfohlen für die Installation auf 12,5 mm dicken Gipskartonoberflächen für die Recessed-Version. PWM Dimmbare Treiber mit Spannungsausgang sind bei Frequenzen zwischen 250 und 500 Hz zu verwenden.

Qualitätszeichen

Das Gerät entspricht der europäischen technischen Norm EN60598-1 und den entsprechenden Zusatzregelungen.

Description

Innovative program of ultra-miniaturized structures in recessed and surface versions. Compatible with a wide range of professional lighting solutions by means of magnetic fixing. The Micro Running Magnet is the ultimate solution for exhibition lighting. A complete and professional program that, in addition to its reduced dimensions, provides a balanced and attractive light to highlight each object in the best way and in 360°.

The quintessence of integrated light obtained thanks to a profile of only 5 mm that allows the total integration of micro-devices designed to be combined with the structure until they disappear almost completely.

The incredibly small profile size that characterizes the program enhances the light's flexibility and its relationship with the architecture. The light-ing bodies are installed by means of a magnetic support inside the profile, providing an unparalleled ease of use.

Magnetic fixing of the luminaires, which allows hot handling. The lighting bodies can be orientated when they are still on, achieving enormous flexibility and adaptability in the configuration at any time.

The profile of all The Micro Running Magnet structural tracks is extruded aluminum, painted black or white, housing a graphite electric track fed at 24V, on which all magnetic luminaires are installed simply by insertion.

Complete range of micro-projectors available in various powers and sizes. They all include professional acrylic stabilized micro-lenses for a maximum control of lighting effects.

Control

- DALI: broadcasting remote control (dimming of all the luminaires in a single group).
 - 1/10V: broadcasting remote control (dimming of all the luminaires in a single group).
 - Casambi: broadcast control through a tablet or smartphone application (FLOS Control®).
- App needed for mobile devices (available in Apple Store y Google Play).

Optic system

The accent light modules are available with intensive optics (spot lens) and extensive optics (medium, flood and wide flood lens). Linear lighting modules with direct diffused or wall-washer light emission, available in different lengths from 300mm up to 1200mm.

Power Supply

Remote 24V power supply not included.

Additional Information

The Micro Running Magnet is a 24V electrical system limited to a maximum power current of 5A and 120W to avoid overloads. After every 120W make a new connection with a feed unit profile. IP20 protection grade. Suitable for installation on normally inflammable surfaces. For Recessed version, installation on 12.5 mm-thick plasterboard surfaces is recommended. PWM Voltage output dimmable drivers shall be used at. Frequencies between 250 and 500 Hz.

Compliance of Standards and Quality Marks

EN60598-1 European Technical Standards and any subsequent additions

FLOS
CONTROL BY CASAMBI



HOW TO ORDER

<p>1 CHOOSE YOUR PROFILE AND LENGTH</p>	<p>2 COMPLETE WITH MOUNTING ACCESSORIES</p>	<p>3 SELECT POWER SUPPLY</p>
<p>RECESSED PROFILE</p>  <p>L: 1 / 1,5 / 2 / 2,5 / 3 m</p>	<p>Feed connector</p>  <hr/> <p>Intermediate connector</p>  <p>Straight</p> <hr/> <p>End cap</p>  <hr/> <p>90° Corner</p>  <p>Electrical / Mechanical joint</p> <hr/> <p>Inner corner</p>  <p>Electrical / Mechanical joint</p>	<p>Recessed installation Remote power supply</p>  <p>25W / 45W / 57W</p> <p>or</p>  <p>120W</p> <p>1/10V or Non Dimmable (select the driver with the appropriate power according to the needs of your project)</p> <hr/>  <p>120W</p> <p>Dali broadcast</p> <hr/>  <p>+</p>  <p>120W</p> <p>or</p> <p>Casambi broadcast (select the driver with the appropriate power according to the needs of your project)</p>
<p>SURFACE/SUSPENSION DOWN PROFILE</p>  <p>L: 1 / 1,5 / 2 / 2,5 / 3 m</p>	<p>Feed connector</p>  <hr/> <p>Intermediate connector</p>  <p>Straight</p> <hr/> <p>End cap</p>  <hr/> <p>90° Corner</p>  <p>Electrical / Mechanical</p> <hr/> <p>Inner corner</p>  <p>Electrical / Mechanical</p>	<p>Recessed installation Remote power supply</p>  <p>25W / 45W / 57W</p> <p>or</p>  <p>120W</p> <p>1/10V or Non Dimmable (select the driver with the appropriate power according to the needs of your project)</p> <hr/>  <p>120W</p> <p>Dali broadcast</p> <hr/>  <p>+</p>  <p>120W</p> <p>or</p> <p>Casambi broadcast (select the driver with the appropriate power according to the needs of your project)</p>

THE MICRO RUNNING MAGNET

4 SELECT A LIGHT MODULE

Light Stripe Diffused



L: 300 mm / 600 mm / 900 mm / 1200 mm



General lighting

Light Stripe Wall-Washer



L: 300 mm / 600 mm / 900 mm / 1200 mm



Wall-Washer

Nano Spot



M/F

Micro Spot



S/M/F

Spot



S/M

Light Shadow Spot



S/M/F/WF

THE MICRO RUNNING MAGNET RECESSED – PROFILES

Profile

Sehr kompaktes elektromechanisches Profil für den Einbau in Gipskartondecken und -wänden in Längen von 1 bis 3 m erhältlich. Befestigungszubehör im Lieferumfang der Profile enthalten. 90°-Ecken auf derselben Ebene verfügbar (symmetrisches Element für die linke und rechte Ecke).

Profiles

Electromechanical profile of reduced size for recessed installation in plasterboard ceilings/walls with lengths from 1 to 3 m. Fastening accessories included with the profiles. 90° corners available in the same plane (symmetrical element for left and right corners).

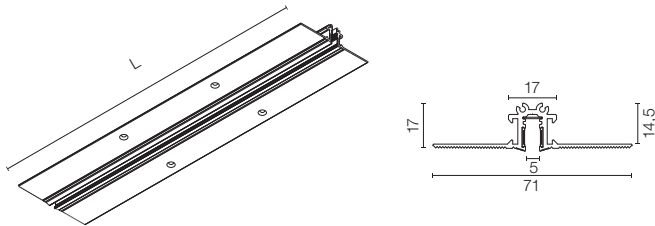

L: 1 m / 1,5 m / 2m / 2,5m / 3 m

- L: 1000 mm 06.6000.14
- L: 1500 mm 06.6001.14
- L: 2000 mm 06.6002.14
- L: 2500 mm 06.6003.14
- L: 3000 mm 06.6004.14

90° Winkel.
Elektrische/mechanische Verbindung. Ohne Stromversorgung. Leuchten können nicht an den Ecken angebracht werden.

90° Corner.
Electrical/mechanical connection. Non-feedable. Luminaires cannot be located on corners.

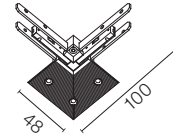

06.6030.14

Innenwinkel.
Elektrische/mechanische Verbindung. Ohne Stromversorgung. Leuchten können nicht an den Ecken angebracht werden.

Inner corner.
Electrical/mechanical connection. Non-feedable. Luminaires cannot be located on corners.

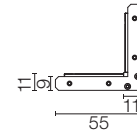

06.6032.14

Versorgungsanschluss.
2 m Kabel enthalten.
Elektrische Verbindung. Leuchten können nicht am Stecker angebracht werden.

Feed connector.
2m cable included.
Electrical connection. Luminaires cannot be located in the connector.

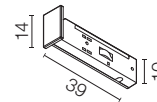

06.6034.14

Mittlerer Verbinder.
Elektrische Verbindung. Leuchten können nicht am Stecker angebracht werden.

Intermediate connector.
Electrical connection. Luminaires cannot be located in the connector.

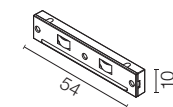

06.6035.14

Endkappe. Set mit 1 Einheit.

End cap. 1 unit kit.



06.6036.14

THE MICRO RUNNING MAGNET SURFACE – PROFILES

Profile

Sehr kompaktes elektromechanisches Profil für die Oberflächenmontage (Decke oder Wand) in Längen von 1 bis 3 m erhältlich. Befestigungszubehör im Lieferumfang der Profile enthalten. 90°-Ecken auf derselben Ebene verfügbar (symmetrisches Element für die linke und rechte Ecke). Die Innenseite des Profils wird immer in Schwarz geliefert.

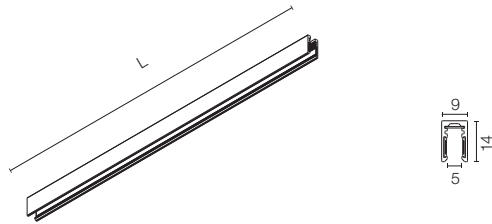

L: 1 m / 1,5 m / 2m / 2,5m / 3 m

Profiles

Electromechanical profile of reduced size for installation on surfaces (ceiling or wall) with lengths from 1 to 3 m. Fastening accessories included with the profiles. 90° corners available in the same plane (symmetrical element for left and right corners). The inner part of the profile is always supplied in black.

- L: 1000 mm
 - 06.6010.40
 - 06.6010.14
- L: 1500 mm
 - 06.6011.40
 - 06.6011.14
- L: 2000 mm
 - 06.6012.40
 - 06.6012.14
- L: 2500 mm
 - 06.6013.40
 - 06.6013.14
- L: 3000 mm
 - 06.6014.40
 - 06.6014.14

90° Winkel.
Elektrische/mechanische Verbindung. Ohne Stromversorgung. Leuchten können nicht an den Ecken angebracht werden.

90° Corner.
Electrical/mechanical connection. Non-feedable. Luminaires cannot be located on corners.

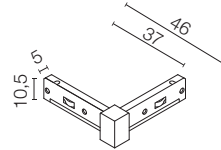

- 06.6031.40
- 06.6031.14

Innenwinkel.
Elektrische/mechanische Verbindung. Ohne Stromversorgung. Leuchten können nicht an den Ecken angebracht werden.

Inner corner.
Electrical/mechanical connection. Non-feedable. Luminaires cannot be located on corners.

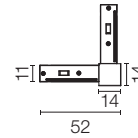

- 06.6033.40
- 06.6033.14

Versorgungsanschluss.
2 m Kabel enthalten.
Elektrische Verbindung. Leuchten können nicht am Stecker angebracht werden.

Feed connector.
2m cable included.
Electrical connection. Luminaires cannot be located in the connector.

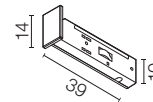

- 06.6034.40
- 06.6034.14

Mittlerer Verbinder.
Elektrische Verbindung. Leuchten können nicht am Stecker angebracht werden.

Intermediate connector.
Electrical connection. Luminaires cannot be located in the connector.

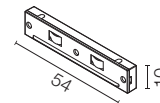

- 06.6035.14

Endkappe. Set mit 1 Einheit.

End cap. 1 unit kit.



- 06.6036.40
- 06.6036.14

THE MICRO RUNNING MAGNET – INSTALLATION PROFILES

SURFACE INSTALLATION

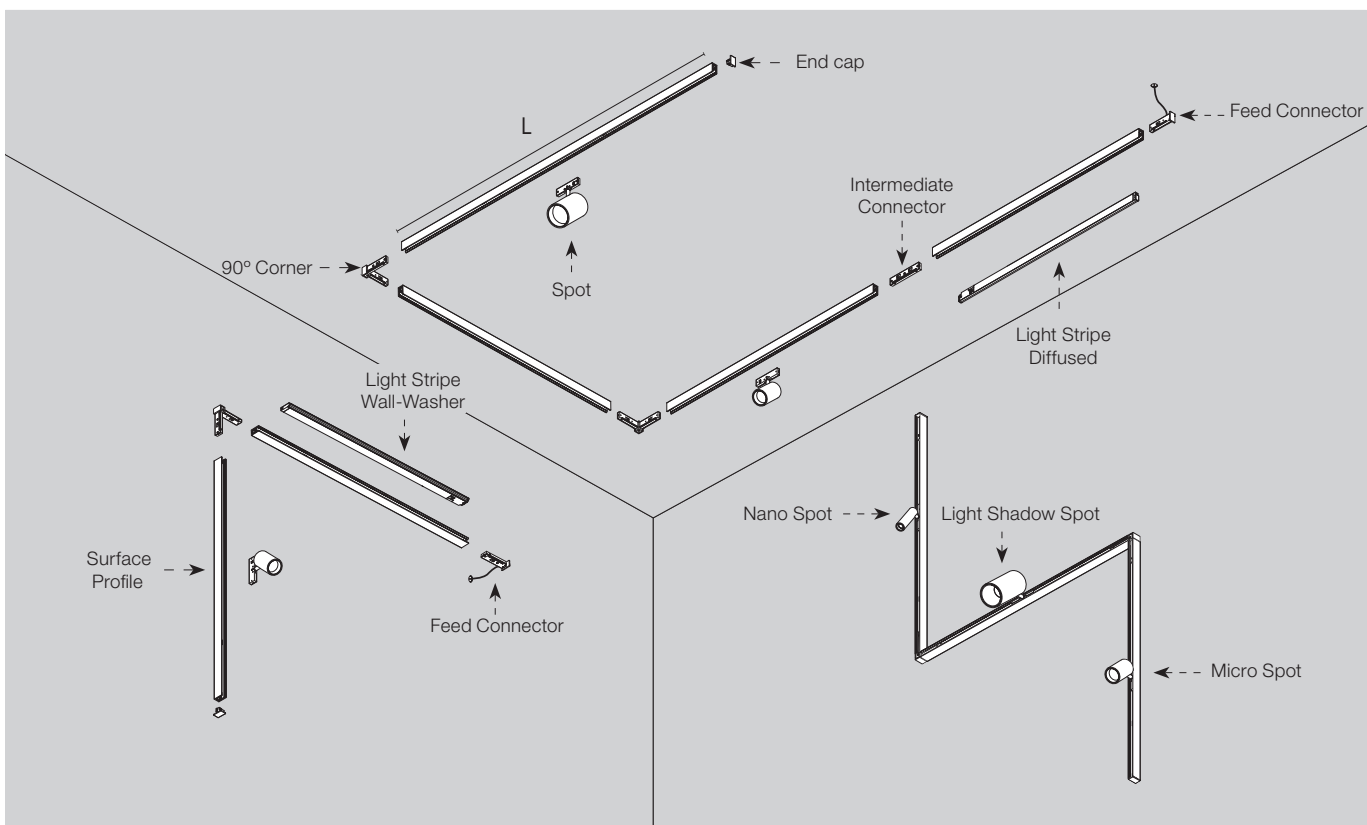

RECESSED INSTALLATION

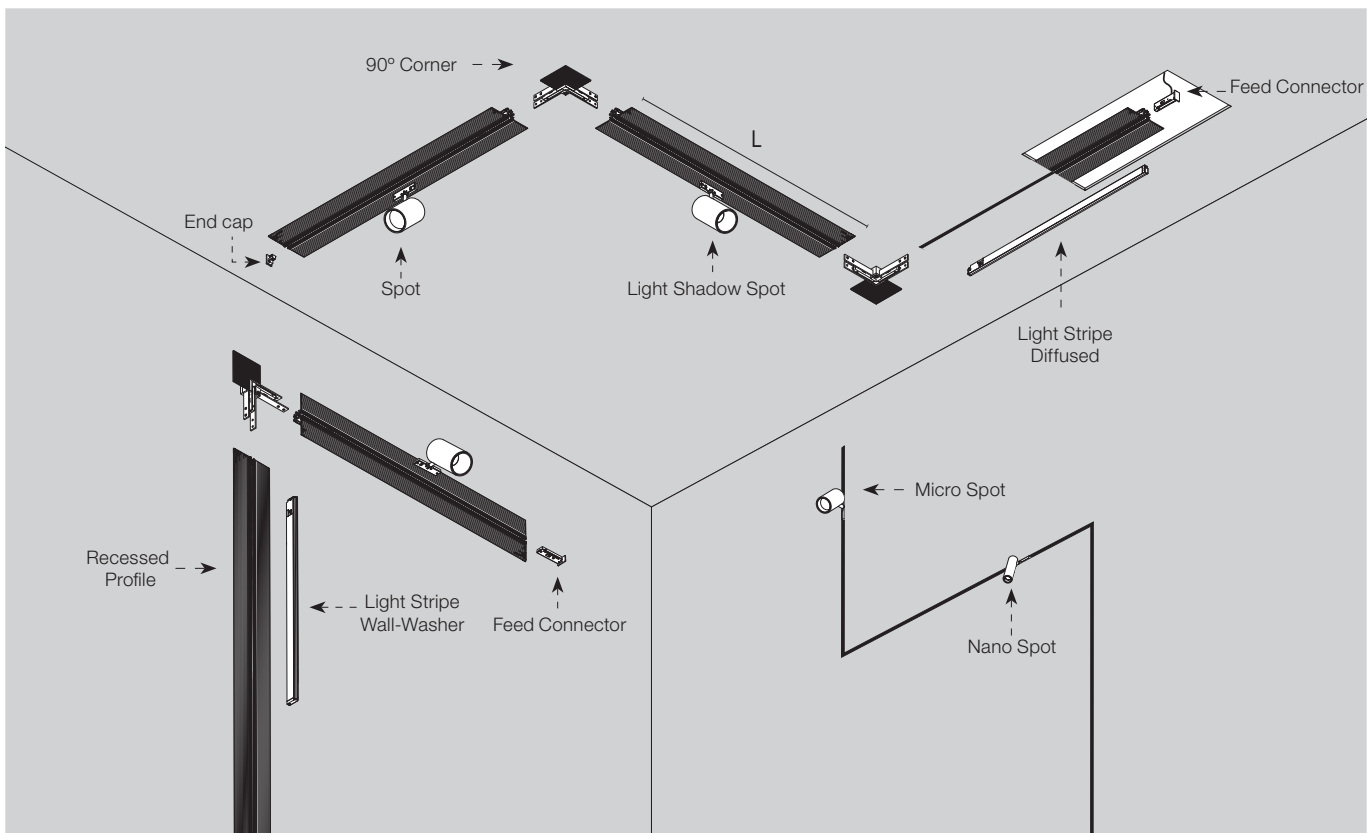

THE MICRO RUNNING MAGNET – FAQ

• Kann ich die Profile schneiden?

Ja. Die Profile können an jeder Stelle geschnitten und die elektrische Verbindung über den Zwischenstecker fortgesetzt werden.

• Can I cut the profiles?

Yes. The profiles can be cut at any point and the electrical connection continued using the intermediate connector.

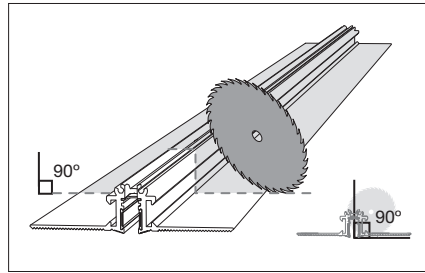

• Kann ich einen Strahler in den Ecken oder zwischen zwei Profilen platzieren?

Nein, die Eckstücke haben keinen freien Platz für Leuchten, die Ecke und die Fugen zwischen den Profilen enthalten die elektrischen Anschlüsse als Zwischenverbinder.

• Can I place a spotlight in the corners or between two profiles?

No, the corner pieces have no free space for luminaires, the corner and the joints between profiles contain the electrical connections as intermediate connectors.

• Kann ich die Leuchten einzeln dimmen?

Nein. Mit den empfohlenen Geräten können sie eingestellt werden, allerdings nicht einzeln.

• Can I dim the luminaires individually?

No. By using the recommended equipment, they can be adjusted, but all at once.

• Was ist die maximale Länge, die mit einem Netzteil an einer Struktur versorgt werden kann?

Die maximale Länge eines Profils, das mit einem Netzteil versorgt werden kann, beträgt 10 Meter.

• What is the maximum length that can be powered with one power supply on a structure?

The maximum length of a profile that can be powered with one power source is 10 metres.

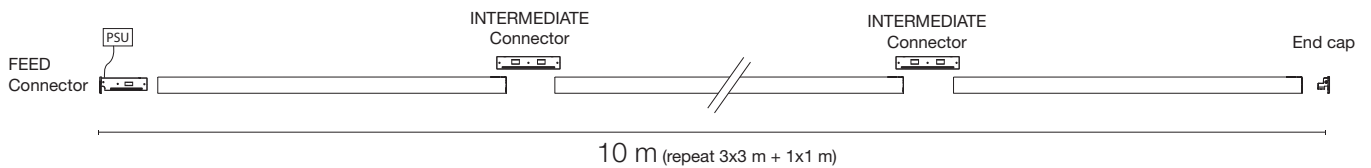

• Kann ich eine Struktur über eine Ecke oder einen Zwischenstecker mit Strom versorgen?

Nein. Die Ecken und der Zwischenstecker dieses Systems können nicht mit Strom versorgt werden.

• Can I power a structure from a corner or intermediate connector?

No. The corners and intermediate connector of this system cannot be powered.

THE MICRO RUNNING MAGNET – LIGHT MODULES

Light Stripe Diffused

Light Source: Top LED 15W/m - 1440 lm/m - 2700K/CRI 90 / 15W/m - 1550 lm/m - 3000K/CRI 90 / 15W/m - 1660 lm/m - 4000K/CRI 90 / 15W/m - 1775 lm/m - 5000K/CRI 90

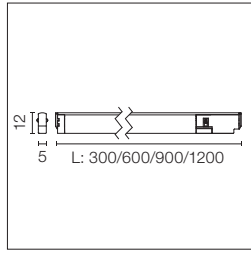

LED-Beleuchtungsmodul mit diffusum Licht für die Installation im System The Micro Running Magnet. Elektronischer DC/DC-Wandler enthalten.

Diffused LED light module to be installed in The Micro Running Magnet System. Built-in DC/DC electronic voltage converter.

2700K
L: 300 mm - 4,5W
03.2260.14

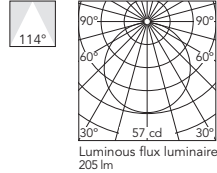

Beam Angle: 114°

h(m)	E(lx)	D(m)
1	57	3.11
2	14	6.21
3	6	9.32
4	4	12.43
5	2	15.53

3000K
L: 300 mm - 4,5W
03.2261.14

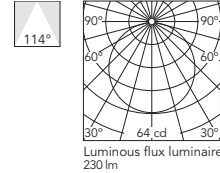

Beam Angle: 114°

h(m)	E(lx)	D(m)
1	64	3.11
2	16	6.21
3	7	9.32
4	4	12.43
5	3	15.53

2700K
L: 600 mm - 9W
03.2264.14

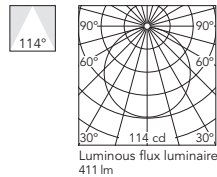

Beam Angle: 114°

h(m)	E(lx)	D(m)
1	114	3.11
2	29	6.21
3	13	9.32
4	7	12.43
5	5	15.53

3000K
L: 600 mm - 9W
03.2265.14

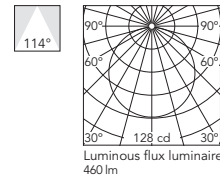

Beam Angle: 114°

h(m)	E(lx)	D(m)
1	128	3.11
2	32	6.21
3	14	9.32
4	8	12.43
5	5	15.53

2700K
L: 900 mm - 13,5W
03.2268.14

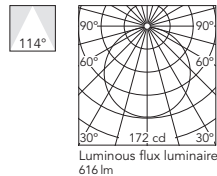

Beam Angle: 114°

h(m)	E(lx)	D(m)
1	172	3.11
2	43	6.21
3	19	9.32
4	11	12.43
5	7	15.53

3000K
L: 900 mm - 13,5W
03.2269.14

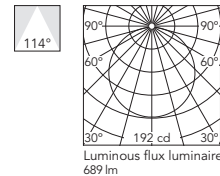

Beam Angle: 114°

h(m)	E(lx)	D(m)
1	192	3.11
2	48	6.21
3	21	9.32
4	12	12.43
5	8	15.53

2700K
L: 1200 mm - 18W
03.2272.14

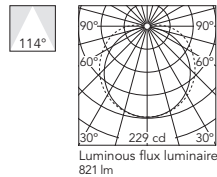

Beam Angle: 114°

h(m)	E(lx)	D(m)
1	229	3.11
2	57	6.21
3	25	9.32
4	14	12.43
5	9	15.53

3000K
L: 1200 mm - 18W
03.2273.14

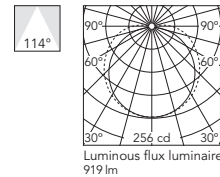

Beam Angle: 114°

h(m)	E(lx)	D(m)
1	256	3.11
2	64	6.21
3	28	9.32
4	16	12.43
5	10	15.53

4000K
L: 300 mm - 4,5W
03.2262.14

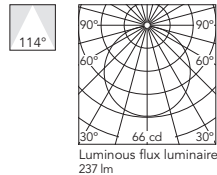

Beam Angle: 114°

h(m)	E(lx)	D(m)
1	66	3.11
2	16	6.21
3	7	9.32
4	4	12.43
5	3	15.53

5000K
L: 300 mm - 4,5W
03.2263.14

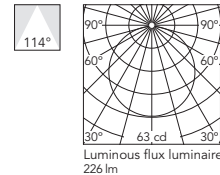

Beam Angle: 114°

h(m)	E(lx)	D(m)
1	63	3.11
2	16	6.21
3	7	9.32
4	4	12.43
5	3	15.53

4000K
L: 600 mm - 9W
03.2266.14

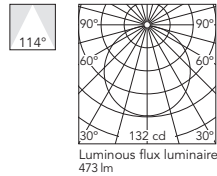

Beam Angle: 114°

h(m)	E(lx)	D(m)
1	132	3.11
2	33	6.21
3	15	9.32
4	8	12.43
5	5	15.53

5000K
L: 600 mm - 9W
03.2267.14

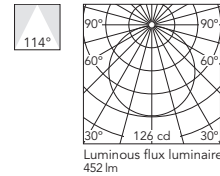

Beam Angle: 114°

h(m)	E(lx)	D(m)
1	126	3.11
2	31	6.21
3	14	9.32
4	8	12.43
5	5	15.53

4000K
L: 900 mm - 13,5W
03.2270.14

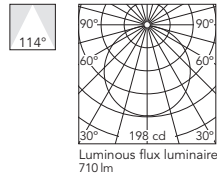

Beam Angle: 114°

h(m)	E(lx)	D(m)
1	198	3.11
2	49	6.21
3	22	9.32
4	12	12.43
5	8	15.53

5000K
L: 900 mm - 13,5W
03.2271.14

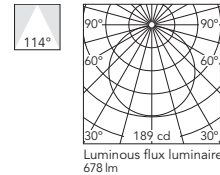

Beam Angle: 114°

h(m)	E(lx)	D(m)
1	189	3.11
2	47	6.21
3	21	9.32
4	12	12.43
5	8	15.53

4000K
L: 1200 mm - 18W
03.2274.14

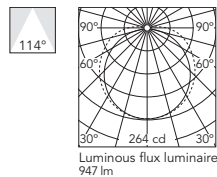

Beam Angle: 114°

h(m)	E(lx)	D(m)
1	264	3.11
2	66	6.21
3	29	9.32
4	16	12.43
5	11	15.53

5000K
L: 1200 mm - 18W
03.2275.14

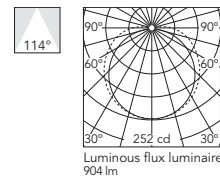

Beam Angle: 114°

h(m)	E(lx)	D(m)
1	252	3.11
2	63	6.21
3	28	9.32
4	16	12.43
5	10	15.53

THE MICRO RUNNING MAGNET – LIGHT MODULES

Light Stripe Wall-Washer

Light Source: Top LED 15W/m - 1440 lm/m - 2700K/CRI 90 / 15W/m - 1550 lm/m - 3000K/CRI 90 / 15W/m - 1660 lm/m - 4000K/CRI 90 / 15W/m - 1775 lm/m - 5000K/CRI 90

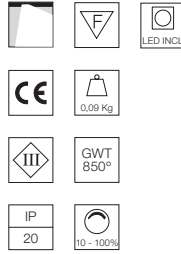
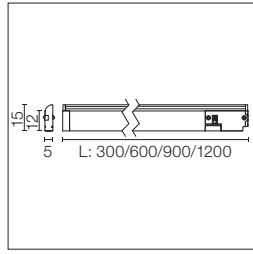

Asymmetrisches LED-Beleuchtungsmodul für Wall-Washer für die Installation im System The Micro Running Magnet. Elektronischer DC/DC-Wandler enthalten.

Asymmetric wall-washer LED light module to be installed in The Micro Running Magnet System. Built-in DC/DC electronic voltage converter.

2700K
L: 300 mm - 4,5W
03.2280.14

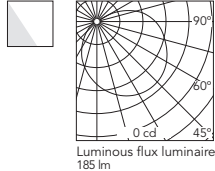

3000K
L: 300 mm - 4,5W
03.2281.14

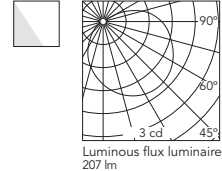

2700K
L: 600 mm - 9W
03.2284.14

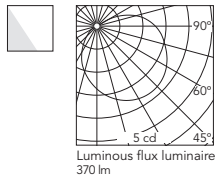

3000K
L: 600 mm - 9W
03.2285.14

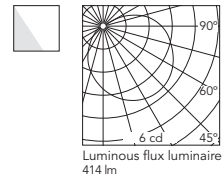

2700K
L: 900 mm - 13,5W
03.2288.14

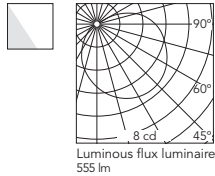

3000K
L: 900 mm - 13,5W
03.2289.14

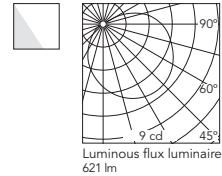

2700K
L: 1200 mm - 18W
03.2292.14

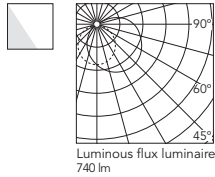

3000K
L: 1200 mm - 18W
03.2293.14

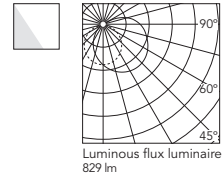

4000K
L: 300 mm - 4,5W
03.2282.14

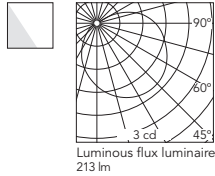

5000K
L: 300 mm - 4,5W
03.2283.14

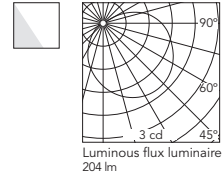

4000K
L: 600 mm - 9W
03.2286.14

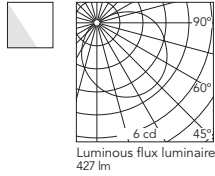

5000K
L: 600 mm - 9W
03.2287.14

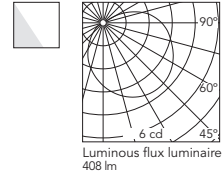

4000K
L: 900 mm - 13,5W
03.2290.14

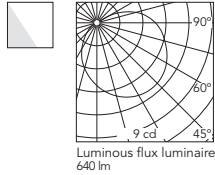

5000K
L: 900 mm - 13,5W
03.2291.14

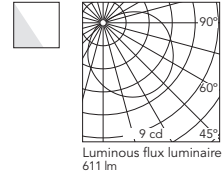

4000K
L: 1200 mm - 18W
03.2294.14

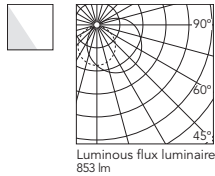

5000K
L: 1200 mm - 18W
03.2295.14

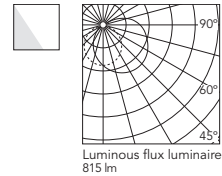

THE MICRO RUNNING MAGNET – LIGHT MODULES

Nano Spot

Light Source: Power LED 2W - 165 lm - 2700K/CRI 90 / 2W - 170 lm - 3000K/CRI 90 / 2W - 185 lm - 4000K/CRI 90 / 2W -200 lm - 5000K/CRI 90

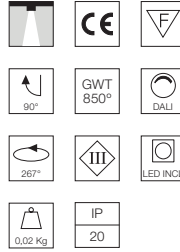
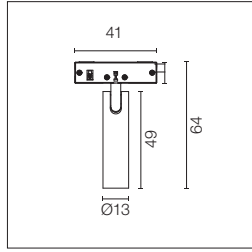

LED-Modul für Akzentbeleuchtung zur Installation in das System The Running Magnet. Elektronischer DC/DC-Wandler enthalten.

Accent lighting LED module to be installed in The Running Magnet System. Built-in DC/DC electronic voltage converter.

Optic Medium 2700K

- 03.2210.40A
- 03.2210.14A

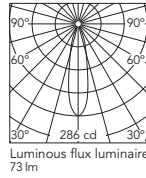

Beam Angle: 23°

h(m)	E lx	D(m)
1	286	0.41
2	72	0.83
3	32	1.24
4	18	1.65
5	11	2.06

Luminous flux luminaire 286 cd
73 lm

Optic Flood 2700K

- 03.2215.40A
- 03.2215.14A

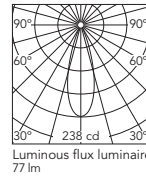

Beam Angle: 32°

h(m)	E lx	D(m)
1	238	0.57
2	60	1.15
3	26	1.72
4	15	2.29
5	10	2.87

Luminous flux luminaire 238 cd
77 lm

3000K

- 03.2211.40A
- 03.2211.14A

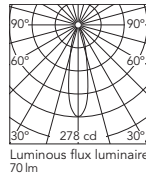

Beam Angle: 23°

h(m)	E lx	D(m)
1	278	0.41
2	69	0.83
3	31	1.24
4	17	1.65
5	11	2.06

Luminous flux luminaire 278 cd
70 lm

3000K

- 03.2216.40A
- 03.2216.14A

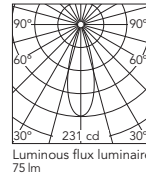

Beam Angle: 32°

h(m)	E lx	D(m)
1	231	0.57
2	58	1.15
3	26	1.72
4	14	2.29
5	9	2.87

Luminous flux luminaire 231 cd
75 lm

4000K

- 03.2212.40A
- 03.2212.14A

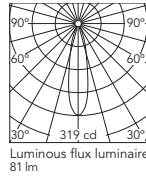

Beam Angle: 28°

h(m)	E lx	D(m)
1	319	0.41
2	80	0.83
3	35	1.24
4	20	1.65
5	13	2.06

Luminous flux luminaire 319 cd
81 lm

4000K

- 03.2217.40A
- 03.2217.14A

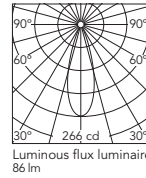

Beam Angle: 31°

h(m)	E lx	D(m)
1	266	0.57
2	66	1.15
3	30	1.72
4	17	2.29
5	11	2.87

Luminous flux luminaire 266 cd
86 lm

5000K

- 03.2213.40A
- 03.2213.14A

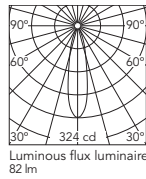

Beam Angle: 23°

h(m)	E lx	D(m)
1	324	0.41
2	81	0.83
3	36	1.24
4	20	1.65
5	13	2.06

Luminous flux luminaire 324 cd
82 lm

5000K

- 03.2218.40A
- 03.2218.14A

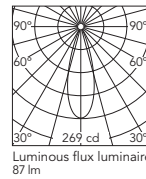

Beam Angle: 32°

h(m)	E lx	D(m)
1	269	0.57
2	67	1.15
3	30	1.72
4	17	2.29
5	11	2.87

Luminous flux luminaire 269 cd
87 lm

THE MICRO RUNNING MAGNET – LIGHT MODULES

Micro Spot

Light Source: Power LED 3W - 275 lm - 2700K/CRI 90 / 3W - 295 lm - 3000K/CRI 90 / 3W - 315 lm - 4000K/CRI 90 / 3W - 335 lm - 5000K/CRI 90

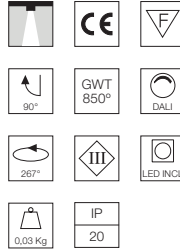
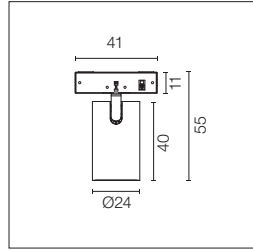

LED-Modul für Akzentbeleuchtung zur Installation in das System The Running Magnet. Elektronischer DC/DC-Wandler enthalten.

Accent lighting LED module to be installed in The Running Magnet System. Built-in DC/DC electronic voltage converter.

Honeycomb zubehör erhältlich. À commander séparément.

Honeycomb accessory available. Must be ordered separately.

Optic Spot 2700K

03.2300.40A
03.2300.14A

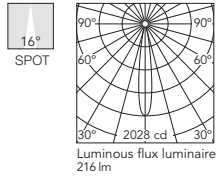

Beam Angle: 16°

h(m)	E(lx)	D(m)
1	2028	0.27
2	507	0.54
3	225	0.82
4	127	1.09
5	81	1.36

Optic Medium 2700K

03.2220.40A
03.2220.14A

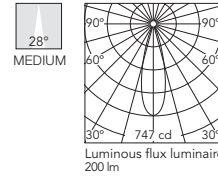

Beam Angle: 28°

h(m)	E(lx)	D(m)
1	747	0.51
2	187	1.02
3	83	1.54
4	47	2.05
5	30	2.56

3000K

03.2301.40A
03.2301.14A

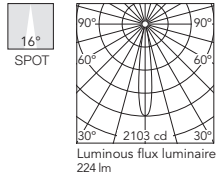

Beam Angle: 16°

h(m)	E(lx)	D(m)
1	2103	0.27
2	526	0.54
3	234	0.82
4	131	1.09
5	84	1.36

3000K

03.2221.40A
03.2221.14A

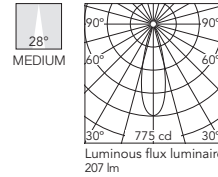

Beam Angle: 28°

h(m)	E(lx)	D(m)
1	775	0.51
2	194	1.02
3	86	1.54
4	48	2.05
5	31	2.56

4000K

03.2302.40A
03.2302.14A

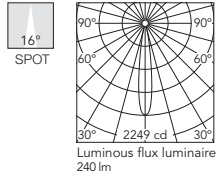

Beam Angle: 16°

h(m)	E(lx)	D(m)
1	2249	0.27
2	562	0.54
3	250	0.82
4	141	1.09
5	90	1.36

4000K

03.2222.40A
03.2222.14A

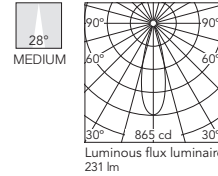

Beam Angle: 28°

h(m)	E(lx)	D(m)
1	865	0.51
2	216	1.02
3	96	1.54
4	54	2.05
5	35	2.56

5000K

03.2303.40A
03.2303.14A

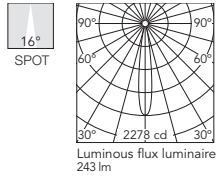

Beam Angle: 16°

h(m)	E(lx)	D(m)
1	2278	0.27
2	570	0.54
3	253	0.82
4	142	1.09
5	91	1.36

5000K

03.2223.40A
03.2223.14A

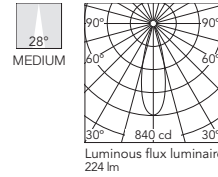

Beam Angle: 28°

h(m)	E(lx)	D(m)
1	840	0.51
2	210	1.02
3	93	1.54
4	52	2.05
5	34	2.56

Optic Flood 2700K

03.2225.40A
03.2225.14A

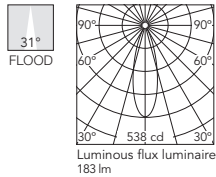

Beam Angle: 31°

h(m)	E(lx)	D(m)
1	538	0.54
2	134	1.09
3	60	1.63
4	34	2.17
5	22	2.72

3000K

03.2226.40A
03.2226.14A

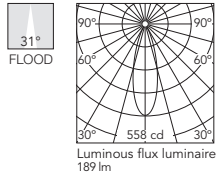

Beam Angle: 31°

h(m)	E(lx)	D(m)
1	558	0.54
2	139	1.09
3	62	1.63
4	35	2.17
5	22	2.72

4000K

03.2227.40A
03.2227.14A

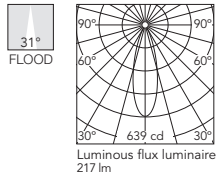

Beam Angle: 31°

h(m)	E(lx)	D(m)
1	639	0.54
2	160	1.09
3	71	1.63
4	40	2.17
5	26	2.72

5000K

03.2228.40A
03.2228.14A

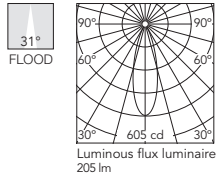

Beam Angle: 31°

h(m)	E(lx)	D(m)
1	605	0.54
2	151	1.09
3	67	1.63
4	38	2.17
5	24	2.72

THE MICRO RUNNING MAGNET – LIGHT MODULES

Spot

Light Source: Power LED 6W - 545 lm - 2700K/CRI 90 / 6W - 585 lm - 3000K/CRI 90 / 6W - 625 lm - 4000K/CRI 90 / 6W - 665 lm - 5000K/CRI 90

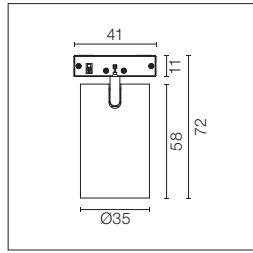

LED-Modul für Akzentbeleuchtung zur Installation in das System The Running Magnet. Elektronischer DC/DC-Wandler enthalten.

Accent lighting LED module to be installed in The Running Magnet System. Built-in DC/DC electronic voltage converter.

Honeycomb zubehör erhältlich. À commander séparément.

Honeycomb accessory available. Must be ordered separately.

Optic Spot 2700K

- 03.2230.40A
- 03.2230.14A

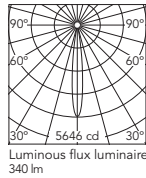

Beam Angle: 13°

h(m)	E(lx)	D(m)
1	5646	0.23
2	1411	0.45
3	627	0.68
4	353	0.90
5	226	1.13

Luminous flux luminaire 340 lm

Optic Medium 2700K

- 03.2235.40A
- 03.2235.14A

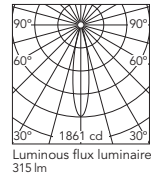

Beam Angle: 20°

h(m)	E(lx)	D(m)
1	1861	0.35
2	465	0.71
3	207	1.06
4	116	1.41
5	74	1.77

Luminous flux luminaire 315 lm

3000K

- 03.2231.40A
- 03.2231.14A

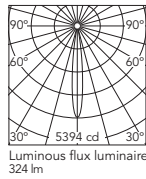

Beam Angle: 13°

h(m)	E(lx)	D(m)
1	5394	0.23
2	1349	0.45
3	599	0.68
4	337	0.90
5	216	1.13

Luminous flux luminaire 324 lm

3000K

- 03.2236.40A
- 03.2236.14A

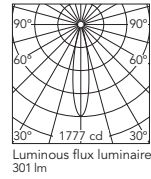

Beam Angle: 20°

h(m)	E(lx)	D(m)
1	1777	0.35
2	444	0.71
3	197	1.06
4	111	1.41
5	71	1.77

Luminous flux luminaire 301 lm

4000K

- 03.2232.40A
- 03.2232.14A

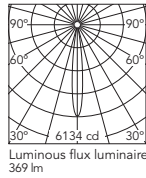

Beam Angle: 13°

h(m)	E(lx)	D(m)
1	6134	0.23
2	1534	0.45
3	682	0.68
4	383	0.90
5	245	1.13

Luminous flux luminaire 369 lm

4000K

- 03.2237.40A
- 03.2237.14A

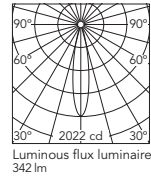

Beam Angle: 20°

h(m)	E(lx)	D(m)
1	2022	0.35
2	505	0.71
3	225	1.06
4	126	1.41
5	81	1.77

Luminous flux luminaire 342 lm

5000K

- 03.2233.40A
- 03.2233.14A

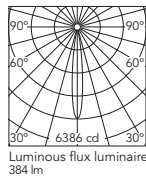

Beam Angle: 13°

h(m)	E(lx)	D(m)
1	6386	0.23
2	1597	0.45
3	710	0.68
4	399	0.90
5	255	1.13

Luminous flux luminaire 384 lm

5000K

- 03.2238.40A
- 03.2238.14A

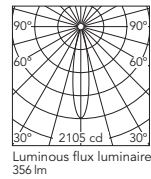

Beam Angle: 20°

h(m)	E(lx)	D(m)
1	2105	0.35
2	526	0.71
3	234	1.06
4	132	1.41
5	84	1.77

Luminous flux luminaire 356 lm

THE MICRO RUNNING MAGNET – LIGHT MODULES

Light Shadow Spot

Light Source: Power LED 3W - 270 lm - 2700K/CRI 90 / 3W - 285 lm - 3000K/CRI 90 / 3W - 300 lm - 4000K/CRI 90 / 3W - 320 lm - 5000K/CRI 90

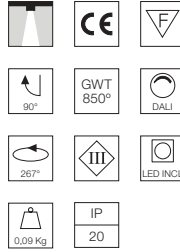
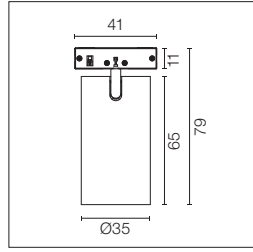

LED-Modul für Akzentbeleuchtung zur Installation in das System The Running Magnet. Elektronischer DC/DC-Wandler enthalten.

Accent lighting LED module to be installed in The Running Magnet System. Built-in DC/DC electronic voltage converter.

Optic Spot 2700K
03.2240.40
03.2240.14

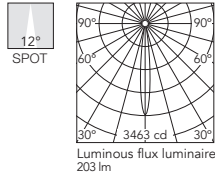

h(m)	E(lx)	D(m)
1	3463	0.21
2	866	0.42
3	385	0.63
4	216	0.84
5	139	1.05

Optic Medium 2700K
03.2245.40
03.2245.14

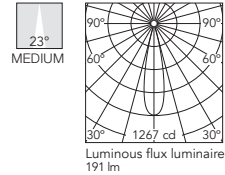

h(m)	E(lx)	D(m)
1	1267	0.40
2	317	0.80
3	141	1.20
4	79	1.60
5	51	2.00

3000K
03.2241.40
03.2241.14

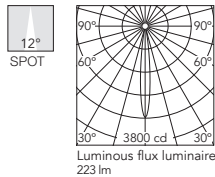

h(m)	E(lx)	D(m)
1	3800	0.21
2	950	0.42
3	422	0.63
4	237	0.84
5	152	1.05

3000K
03.2246.40
03.2246.14

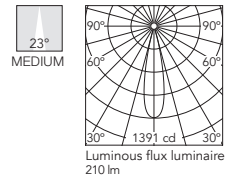

h(m)	E(lx)	D(m)
1	1391	0.40
2	348	0.80
3	155	1.20
4	87	1.60
5	56	2.00

4000K
03.2242.40
03.2242.14

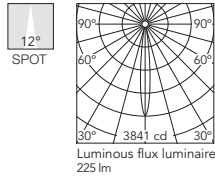

h(m)	E(lx)	D(m)
1	3841	0.21
2	960	0.42
3	427	0.63
4	240	0.84
5	154	1.05

4000K
03.2247.40
03.2247.14

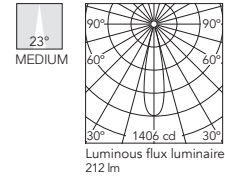

h(m)	E(lx)	D(m)
1	1406	0.40
2	351	0.80
3	156	1.20
4	88	1.60
5	56	2.00

5000K
03.2243.40
03.2243.14

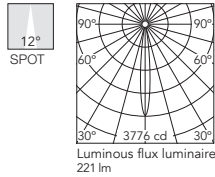

h(m)	E(lx)	D(m)
1	3776	0.21
2	944	0.42
3	420	0.63
4	236	0.84
5	151	1.05

5000K
03.2248.40
03.2248.14

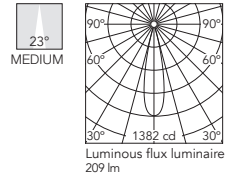

h(m)	E(lx)	D(m)
1	1382	0.40
2	345	0.80
3	154	1.20
4	86	1.60
5	55	2.00

Optic Flood 2700K
03.2250.40
03.2250.14

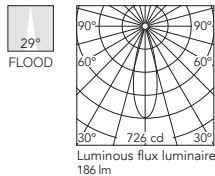

h(m)	E(lx)	D(m)
1	726	0.51
2	182	1.03
3	81	1.54
4	45	2.05
5	29	2.57

Optic Wide Flood 2700K
03.2255.40
03.2255.14

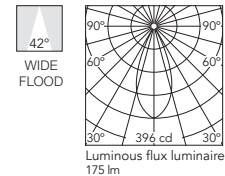

h(m)	E(lx)	D(m)
1	396	0.77
2	99	1.53
3	44	2.30
4	25	3.07
5	16	3.83

3000K
03.2251.40
03.2251.14

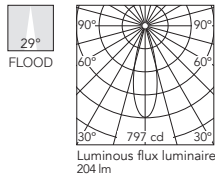

h(m)	E(lx)	D(m)
1	797	0.51
2	199	1.03
3	89	1.54
4	50	2.05
5	32	2.57

3000K
03.2256.40
03.2256.14

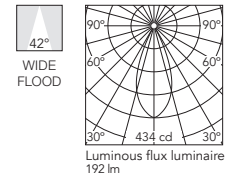

h(m)	E(lx)	D(m)
1	434	0.77
2	108	1.53
3	48	2.30
4	27	3.07
5	17	3.83

4000K
03.2252.40
03.2252.14

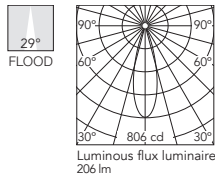

h(m)	E(lx)	D(m)
1	806	0.51
2	201	1.03
3	90	1.54
4	50	2.05
5	32	2.57

4000K
03.2257.40
03.2257.14

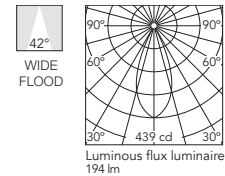

h(m)	E(lx)	D(m)
1	439	0.77
2	110	1.53
3	49	2.30
4	27	3.07
5	18	3.83

5000K
03.2253.40
03.2253.14

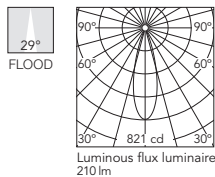

h(m)	E(lx)	D(m)
1	821	0.51
2	205	1.03
3	91	1.54
4	51	2.05
5	33	2.57

5000K
03.2258.40
03.2258.14

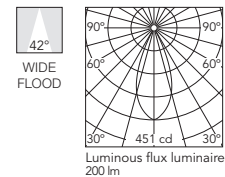

h(m)	E(lx)	D(m)
1	451	0.77
2	113	1.53
3	50	2.30
4	28	3.07
5	18	3.83

THE MICRO RUNNING MAGNET

Zubehör / Accessories

Micro Spot

Honeycomb.

Honeycomb.



08.0190.14

Spot

Honeycomb.

Honeycomb.



08.0191.14

Treiber / Drivers

Remote Installation

Fernspeisung 24V.

Dimmbar durch 1/10V Protokoll oder No Dimable.

Dimmbereich 100-20 %.

24V remote power supply.

Dimmable through 1/10V protocol or Non Dimmable.

Dimming range 20-100%.

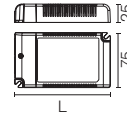

25W 110/240V – L:110

60.9359

36W-110V / 45W-240V – L:120

60.9360

57W 220/240V – L:130

60.9361

Remote Installation

Fernspeisung 24V.

Dimmbar durch 0/1-10V -Protokoll.

Dimmbereich 10-100%.

Mindestlast 20W.

24V remote power supply.

Dimmable through 0/1-10V protocol.

Dimming range 10-100%. Minimum load 20W.

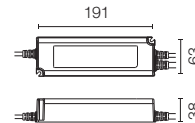

120W 110*/240V

60.9681

*UL max 100W

DALI

Remote Installation

Fernspeisung 24V.

Dimmbar durch DALI2-Protokoll.

Dimmbereich 10-100%.

Mindestlast 20W.

24V remote power supply.

Dimmable through DALI2 protocol.

Dimming range 10-100%. Minimum load 20W.

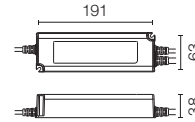

120W 110*/240V

60.9682

*UL max 100W

Casambi

Remote Installation

Fernspeisung 24V.

Dimmbar durch Casambi Protokoll.

Dimmbereich 10-100%.

Mindestlast 20W.

24V remote power supply.

Dimmable through Casambi protocol. Dimming range 10-100%.

Minimum load 20W.

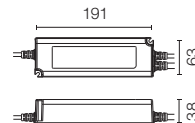

120W - 110*/240V

60.9683

*UL max 100W

Casambi

Remote Installation

Kontroller Casambi 220-240V.

Benötigt 24V, 1-10V oder Dali-

Treiber, separat bestellen.

Nur mit 60.9359, 60.9360 oder

60.9361 verwenden.

Dimmbereich 100-20 %.

Casambi controller 220-240V.

Requires 24V, 1-10V or Dali driver.

It must be ordered separately. Use

only with 60.9359, 60.9360 or

60.9361. Dimming range 20-100%.

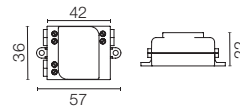

60.9392

THE MICRO RUNNING MAGNET

Remote Driver Installations - Broadcast

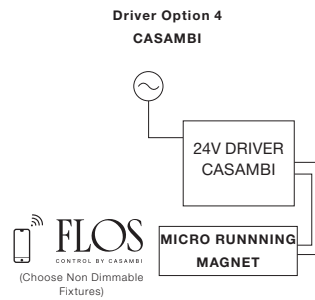
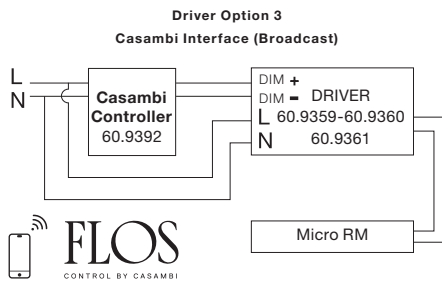
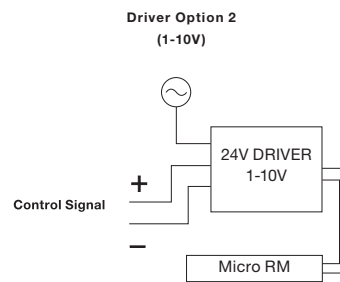
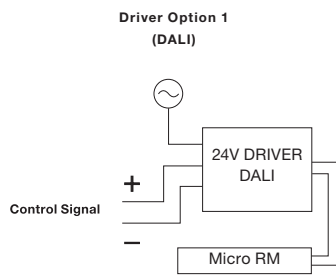
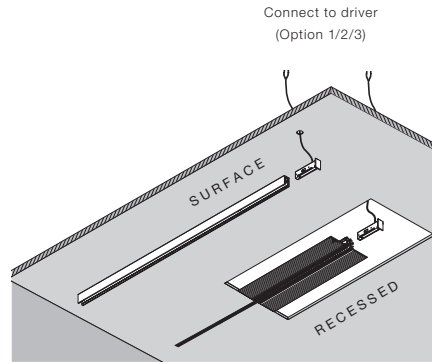

THE RUNNING MAGNET

DESIGNED BY FLOS ARCHITECTURAL

RECESSED

SURFACE

SUSPENSION
UP&DOWN / DOWN

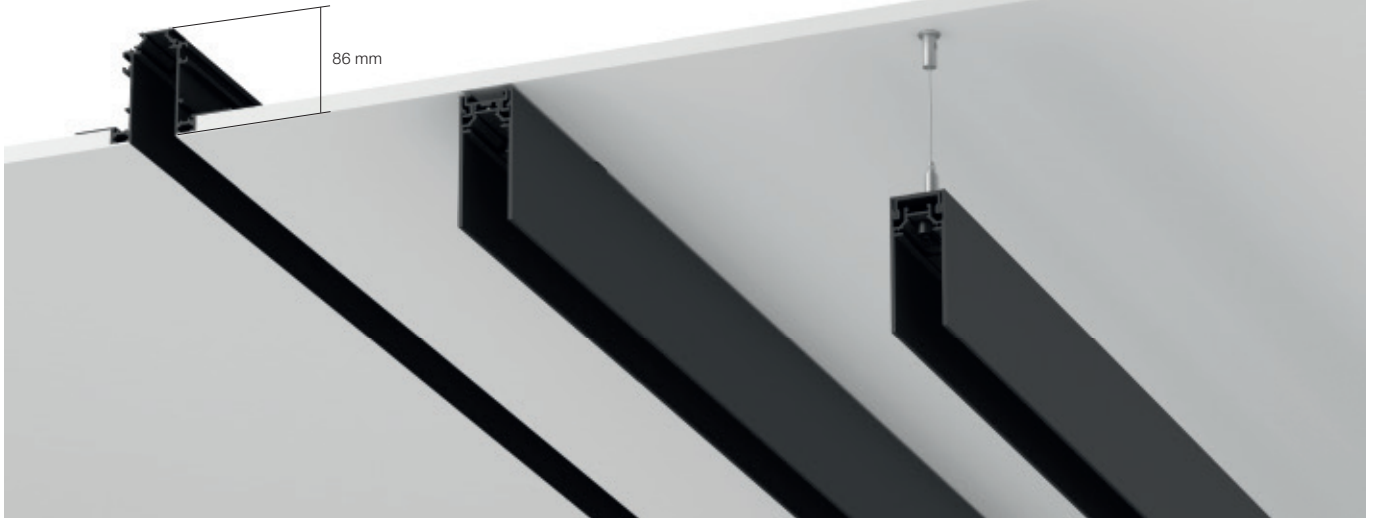

Recessed Profiles 14 Schwarz
14 Black

Surface/Suspension Profiles 40 Weiss
40 White 14 Schwarz
14 Black

LIGHT MODULES

LIGHT STRIPE



LIGHT SOURCE
TOP LED
25W/m
2060 lm/m
2700K/CRI 90
2178 lm/m
3000K/CRI 90

SPOT MODULE



LIGHT SOURCE
POWER LED
8W
560 lm
2700K/CRI 90
600 lm
3000K/CRI 90

SPOT 120



LIGHT SOURCE
POWER LED
12,5W/14W DALI
985 lm
2700K/CRI 90
1060 lm
3000K/CRI 90

MULTI SPOT 4



LIGHT SOURCE
POWER LED
10W
4x226 lm
2700K/CRI 90
4x240 lm
3000K/CRI 90

LIGHT SHADOW



LIGHT SOURCE
POWER LED
10,8W
4x270 lm
2700K/CRI 90
4x285 lm
3000K/CRI 90

LIGHT SHADOW W-W



LIGHT SOURCE
POWER LED
10,8W
4x270 lm
2700K/CRI 90
4x285 lm
3000K/CRI 90

STRING LIGHT



LIGHT SOURCE
POWER LED
16W
1310 lm
2700K/CRI 90
1404 lm
3000K/CRI 90

MINI GLO-BALL



LIGHT SOURCE
POWER LED
3,5/7W
2700K/CRI 80
3000K/CRI 80

FIND ME SUSPENSION



LIGHT SOURCE
POWER LED
8W
560 lm
2700K/CRI 90
600 lm
3000K/CRI 90

ANTHONY SPOT TRACK



LIGHT SOURCE
POWER LED
16W
1310 lm
2700K/CRI 90
1404 lm
3000K/CRI 90

MULTIFUNCTION SMART DEVICE



FLOS CONTROL®
by Casambi



Light Stripe



Spot



Surface



Suspension



Recessed
Flos Kit
Installation



Recessed
Conventional
Installation

THE RUNNING MAGNET

Produktbeschreibung

Innovatives System für die Innenbeleuchtung zur Montage an der Wand, zum Einbauen oder als Hängeversion für Gipskartonwände oder -decken. Besteht aus diversen Magnetschienen, auf denen die LED-Lichtmodule befestigt werden.

Sämtliche Strukturprofile von Running Magnet wurden aus stranggepresstem Aluminium hergestellt, sind weiß oder schwarz lackiert und haben elektrische Grafitleisten für eine Spannungsversorgung mit 24V. Darauf werden die Beleuchtungs-LEDs magnetisch befestigt.

Die abgehängte Version ist auch für eine indirekte Beleuchtung erhältlich.

Die Familie The Running Magnet erstreckt sich zudem auf Umgebungs- und Akzentbeleuchtungsmodule mit verschiedenen Optiken sowie auf eine Auswahl an dekorativen Leuchten, die aus der FLOS Home Collection herausgenommen und angepasst wurden.

Die Beleuchtungsmodule verfügen über ein magnetisches Befestigungssystem für volle Mobilität und Flexibilität.

Alle Lichtmodule verfügen über einen eingebauten Potentiometer und je nach Wunsch über DALI- oder Casambi-Lichtsteuerung.

Steuerung

- Für Die Steuerung mittels DALI-Protokoll muss der Datenbus direkt an das Profil angeschlossen werden.
- Für die Steuerung mittels Casambi (max. 200 Leuchten) müssen Casambi-Leuchten bestellt werden, diese sind mit allen für das System verfügbaren Profilen kompatibel. Für Mobilgeräte ist die app FLOS Control® powered by Casambi erforderlich (erhältlich im Apple Store und auf Google Play).

Optisches System

Das Akzentlichtmodul ist mit intensiver (spot lens) und mit extensiver Optik (narrow und wide narrow lens) erhältlich.

Einspeisung

Fern-Netzteil 24V nicht enthalten.

Zubehör

- Verschiedene Linsen für Spot Module und Multi Spot 4.
- Externer Abschirmring für Spot Module.
- Elliptische Linse, Flood und Honeycomb für Anthony Spot Track.
- Honeycomb und Querabschirmung im Lieferumfang für Spot 120 enthalten.

Zusatzinformationen

Einbau der Unterputzausführung nur in 12,5mm dicke Gipskartonoberflächen möglich.
The Running Magnet 2.0 ist eine mit 24V gespeiste elektrische Anlage, deren Maximalstrom zur Vorbeugung gegen Überlast auf 8A und 185W beschränkt ist. Nach jeweils 185 W muss über ein Einspeisungsprofil ein neuer Anschluss verlegt werden.
Bei der Up&Down-Ausführung haben die indirekte Beleuchtung und die elektromechanische Schiene separate Spannungsversorgungen.
Schutzgrad IP20.
Auf normal entflammaren Oberflächen einsetzbar.

Qualitätszeichen

Das Gerät entspricht der europäischen technischen Norm EN60598-1 und den entsprechenden Zusatzregelungen.

Description

Innovative lighting system for indoor use, for surface, suspended or recessed mounting on plasterboard walls or ceilings, comprising a series of magnetic tracks that house the LED lighting modules.

The profile of all The Running Magnet structural tracks is extruded aluminum, painted black or white, housing a graphite electric track fed at 24V, on which all magnetic luminaires are installed simply by insertion.

Suspended track is also available with the option of indirect lighting.

The Running Magnet family is completed with ambient lighting units and accent units with different optics, as well as a selection of decorative luminaires taken and adapted from FLOS Home Collection.

The lighting modules incorporate a magnetic mounting system for total mobility and flexibility. All light modules are available with on board potentiometer, DALI dimmable option and Casambi.

Control

- To manage using DALI protocol, it is necessary to connect the control data bus directly to the profile.
- To manage using Casambi (Max. 200 luminaires) it is necessary to order fixtures in the Casambi version, these are compatible with all profiles available for the system. The app FLOS Control® powered by Casambi for mobile devices is also necessary (available on Apple Store and Google Play).

Optic system

The accent light module is available with intensive optics (spot lens) and extensive optics (narrow and wide narrow lens).

Power Supply

Remote 24V power supply not included.

Accessories

- Different lenses for Spot Module and Multi Spot 4.
- Screening external ring for Spot Module.
- Elliptical, flood lens and honeycomb for Anthony Spot Track.
- Honeycomb and crosspiece included in Spot 120.

Additional Information

The Recessed version can only be installed on 12.5 mm thick plasterboard surfaces.
The Running Magnet 2.0 is a 24V electrical system limited to a maximum power current of 8A and 185W to avoid overloads.
After every 185W make a new connection with a feed unit profile.
In the Up&Down version indirect illumination and the electromechanical track are powered independently.
IP20 protection grade.
Suitable for installation on normally inflammable surfaces.

Compliance of Standards and Quality Marks

EN60598-1 European Technical Standards and any subsequent additions.

FLOS
CONTROL BY CASAMBI



HOW TO ORDER

1 CHOOSE YOUR PROFILE AND LENGTH

RECESSED PROFILE



L: 1 / 1,5 / 2 / 2,5 / 3 m

2 COMPLETE WITH MOUNTING ACCESSORIES

End cap



Included with feed profile

90° Corner



Electrical / mechanical joint

Inner corner



Electrical / mechanical joint

Outer corner



Electrical / mechanical joint



Recessed installation

Accessories

Fixed ceiling kit



Adjustable ceiling kit



or

SURFACE/SUSPENSION DOWN PROFILE

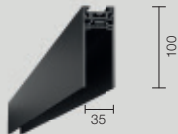

L: 1 / 1,5 / 2 / 2,5 / 3 m

End cap



Included with feed profile

90° Corner



Electrical / mechanical joint

Inner corner



Electrical / mechanical joint



Surface installation

Accessories

Fixed ceiling kit
(Included)



Suspension kit



Included with profile



Suspension Down installation

Surface rose



or

Recessed rose



SUSPENSION UP&DOWN PROFILE



L: 1 / 1,5 / 2 / 2,5 / 3 m

End cap



Included with feed profile

90° Corner



Electrical / mechanical joint



Suspension Up&Down installation

Accessories

Intermediate suspension kit



Included with profile

Surface rose



or

Recessed rose



THE RUNNING MAGNET

3 SELECT POWER SUPPLY AND CONTROL OPTION

Recessed installation

Remote power supply



(select the driver with the appropriate power according to the needs of your project)

Surface installation

Remote power supply



Non Dimmable / Dali / Spots Casambi

(select the driver with the appropriate power according to the needs of your project)

Suspension Down installation

Remote power supply



(select the driver with the appropriate power according to the needs of your project)

Surface power supply

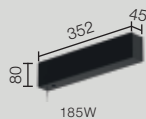

185W

Non Dimmable / Dali / Spots Casambi

Suspension Up&Down installation

Remote power supply

Surface power supply

Down instal.

Up instal.

Down instal.

Up instal.



(select the driver with the appropriate power according to the needs of your project)



185W

Non Dim / Spots Casambi



60W / 120W

or



60W / 120W

(select the driver with the appropriate power according to the needs of your project)



200W

(select the driver with the appropriate power according to the needs of your project)



185W

Dali

4 SELECT A LIGHT MODULE AND CONTROL OPTION

Non Dimmable / Dali / Casambi

Light Stripe



Spot Module



Spot 120



Multi Spot 4



Light Shadow



Light Shadow W-W



String Light



Mini Glo-Ball



Find Me Suspension



Anthony Spot Track



Multifunction Smart Device

FLOS Control® by Casambi



THE RUNNING MAGNET RECESSED – PROFILES

Profile

Elektromechanisches Profil für Einbauinstallationen in Decken/Wänden aus Gipskarton.

Lineare Profile in zwei Versionen erhältlich: Einspeisungsprofile zum Anschließen an einen Treiber und Zwischenprofile. Beide Versionen haben eine Länge zwischen 1 m und 3 m. Abdeckungen sind bei den Einspeisungsprofilen enthalten.

90°-Ecken auf derselben Ebene verfügbar (symmetrisches Element für die linke und rechte Ecke), symmetrische 90°-Innen- und Außenecken auf verschiedenen Ebenen. Für den Anschluss an einen Treiber ausgestattet. Befestigungssets, fest oder verstellbar, verfügbar (optional). Die Befestigungssets für die Decke ermöglichen die Installation ohne Befestigungsprofile aus Aluminium. Empfohlen für Installationen, bei denen das Profil Running Magnet vor der Zwischendecke aus Gipskarton installiert werden kann.

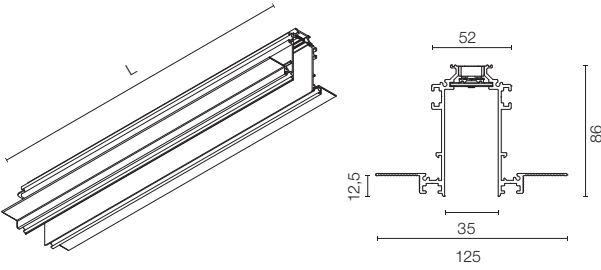

L: 1 m / 1,5 m / 2 m / 2,5 m / 3 m

Profiles

Electromechanical profile for recessed installation in plasterboard ceilings and walls.

Linear profiles available in two versions: power feed profiles for connecting to a driver, and intermediate profiles. Both versions available in lengths from 1 m to 3 m. Covers included with the power feed profiles.

90° corners available in the same plane (symmetrical element for left and right corners), symmetrical 90° inner and outer corners in different planes. For connection to the driver.

Permanent or adjustable fastening kits available (optional). The fastening kits for the roof permit installing without using aluminium fastening profiles. Recommended for installations where the Running Magnet cannot be installed before the suspended plasterboard ceiling.

Feed Unit Profiles

L: 1000 mm

■ 06.1638.14

L: 1500 mm

■ 06.1639.14

L: 2000 mm

■ 06.1640.14

L: 2500 mm

■ 06.1641.14

L: 3000 mm

■ 06.1642.14

Intermediate Profiles

L: 1000 mm

■ 06.1643.14

L: 1500 mm

■ 06.1644.14

L: 2000 mm

■ 06.1645.14

L: 2500 mm

■ 06.1646.14

L: 3000 mm

■ 06.1647.14

90° Winkel.
Kann mit Strom versorgt werden.

90° Corner.
Can be powered.

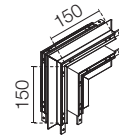

■ 06.1648.14

Innenwinkel.
Kann mit Strom versorgt werden.

Inner corner.
Can be powered.

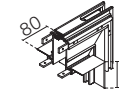

■ 06.1650.14

Außenwinkel.
Kann mit Strom versorgt werden.

Outer corner.
Can be powered.

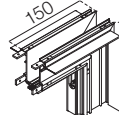

■ 06.1651.14

Befestigungsatz feste decke
(fakultativ). Set mit 2 stück.

Fixed ceiling kit (optional).
2 unit kit.

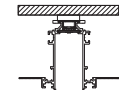

■ 08.8866.14

Befestigungsatz an absenkbare
decke (fakultativ). Set mit 2 stück.

Adjustable ceiling kit (optional).
2 unit kit.

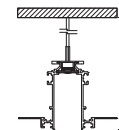

■ 08.8867.14

Profile (mm)	Quantities Ceiling Kit (units)
1000 / 1500	2
2000 / 2500	3
3000	4

Die Einspeisungsprofile werden stets mit Abdeckung geliefert. Abdeckungen müssen nur dann separat bestellt werden, wenn die Installation ausschließlich aus Zwischenprofilen besteht und über die Winkel versorgt wird.

End caps come complete with all the feed unit profiles. These should only be ordered separately if the installation is exclusively composed of intermediate profiles and fed by corners.



■ 08.8865.14A

THE RUNNING MAGNET SURFACE – PROFILES

Profile

Elektromechanisches Profil für Aufputzinstallationen.
Lineare Profile in zwei Versionen erhältlich: Einspeisungsprofil zum Anschließen an einen Treiber und Zwischenprofile. Beide Versionen haben eine Länge zwischen 1 m und 3 m.
Abdeckungen sind bei den Einspeisungsprofilen enthalten.
Befestigungszubehör bei allen Produkten enthalten.
90°-Ecken auf derselben Ebene (symmetrisches Element für die linke und rechte Ecke) und symmetrische 90°-Innenecken auf verschiedenen Ebenen verfügbar, in den Versionen Surface und Down. Für den Anschluss an einen Treiber ausgestattet.
Die Innenseite des Profils wird immer in Schwarz geliefert.

Profiles

Electromechanical profile for surface-mounting.
Linear profiles available in two versions: power feed profiles for connecting to a driver, and intermediate profiles. Both versions available in lengths from 1 m to 3 m.
Covers included with the power feed profiles. Attachment accessories included with all products.
90° corners available in the same plane (symmetrical element for left and right corner) and 90° symmetrical internal corners in a different plane, for the Surface and Down versions. For connection to the driver.
The inner part of the profile is always supplied in black.

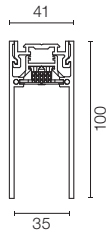
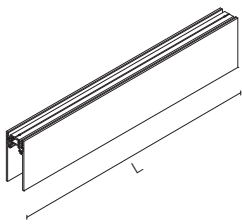

L: 1 m / 1,5 m / 2 m / 2,5 m / 3 m

Feed Unit Profiles

- L: 1000 mm
06.1600.40 (white)
06.1600.14 (black)
- L: 1500 mm
06.1601.40 (white)
06.1601.14 (black)
- L: 2000 mm
06.1602.40 (white)
06.1602.14 (black)
- L: 2500 mm
06.1603.40 (white)
06.1603.14 (black)
- L: 3000 mm
06.1604.40 (white)
06.1604.14 (black)

Intermediate Profiles

- L: 1000 mm
06.1605.40 (white)
06.1605.14 (black)
- L: 1500 mm
06.1606.40 (white)
06.1606.14 (black)
- L: 2000 mm
06.1607.40 (white)
06.1607.14 (black)
- L: 2500 mm
06.1608.40 (white)
06.1608.14 (black)
- L: 3000 mm
06.1609.40 (white)
06.1609.14 (black)

90° Winkel.
Kann mit Strom versorgt werden.

90° Corner.
Can be powered.

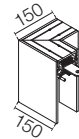

- 06.1610.40 (white)
- 06.1610.14 (black)

Innenwinkel.
Kann mit Strom versorgt werden.

Inner corner.
Can be powered.

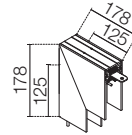

- 06.1612.40 (white)
- 06.1612.14 (black)

Die Einspeisungsprofile werden stets mit Abdeckung geliefert. Abdeckungen müssen nur dann separat bestellt werden, wenn die Installation ausschließlich aus Zwischenprofilen besteht und über die Winkel versorgt wird.

End caps come complete with all the feed unit profiles. These should only be ordered separately if the installation is exclusively composed of intermediate profiles and fed by corners.



- 08.8887.40A (white)
- 08.8887.14A (black)

THE RUNNING MAGNET SUSPENSION UP&DOWN – PROFILES

Profiles

Elektromechanisches Profil für hängende Installationen. Die linearen Elemente in der Version Up&Down enthalten eine indirekte LED-Beleuchtung im oberen Bereich des Profils. Die Spannungsversorgung kann über den allgemeinen oder einen separaten Anschluss erfolgen. Lineare Profile in zwei Versionen erhältlich: Einspeisungsprofile zum Anschließen an einen Treiber und Zwischenprofile. Beide Versionen haben eine Länge zwischen 1 m und 3 m. Abdeckungen sind bei den Einspeisungsprofilen enthalten. Zubehör zum Anschließen (Netzkabel 4,2 m) und Aufhängen (Stahlkabel 4 m) an der Decke bei allen linearen Einspeisungs- oder Zwischenelementen enthalten. 90°-Ecken auf derselben Ebene verfügbar (symmetrisches Element für die linke und rechte Ecke). Nicht für den Anschluss an einen Treiber ausgestattet. Die Ecken bei der Hängeausführung des Running Magnet haben keine indirekte Beleuchtung. Die indirekte Beleuchtung kann als separater Stromkreis gesteuert werden, wenn sie von einem speziellen Gerät gespeist wird. Bei einer DALI-Installation muss ein optionales DALI-Steuergerät separat bestellt werden. Die Profile können nicht gekürzt werden. Die Innenseite des Profils wird immer in Schwarz geliefert.

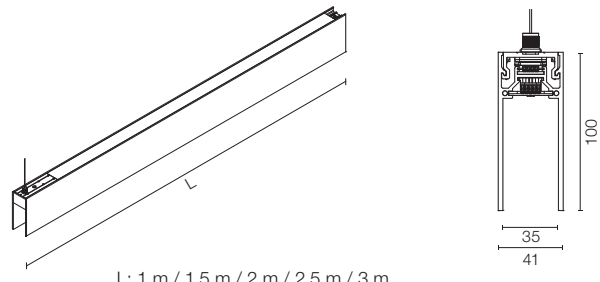

Profiles

Electromechanical profile for suspended installations. Linear elements in the Up&Down version include indirect LED illumination in the upper part of the profile. Shared or separate power feed. Linear profiles available in two versions: power feed profiles for connecting to a driver, and intermediate profiles. Both versions available in lengths from 1 m to 3 m. Covers included with the power feed profiles. Ceiling connection (4.2 m feed cable) and suspension (4m steel cable) accessories included in all linear feed or intermediate products. 90° corners in the same plane (symmetrical element for right and left corners). Not provided for connection to the driver. The corners of the Suspended Running Magnet versions are not fitted with indirect illumination. Indirect illumination can be managed as a separate circuit if powered by a dedicated driver and, in the case of the DALI installation, if equipped with a dedicated optional DALI controller. To be ordered separately. Profiles cannot be cut. The inner part of the profile is always supplied in black.

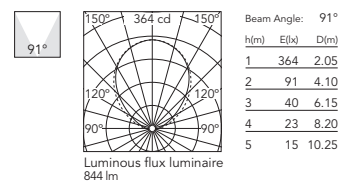

Light Source: Top LED 8,4W/m Up - 950 lm/m Up - 3000K/CRI 90

Feed Unit Profiles

L: 1000 mm			Beam Angle: 91° h(m) E(l) D(m) 1 364 2.05 2 91 4.10 3 40 6.15 4 23 8.20 5 15 10.25 Luminous flux luminaire 844 lm
06.1614.40A 06.1614.14A			
L: 1500 mm			Beam Angle: 91° h(m) E(l) D(m) 1 546 2.05 2 136 4.10 3 61 6.15 4 34 8.20 5 22 10.25 Luminous flux luminaire 1266 lm
06.1615.40A 06.1615.14A			
L: 2000 mm			Beam Angle: 91° h(m) E(l) D(m) 1 728 2.05 2 182 4.10 3 81 6.15 4 45 8.20 5 29 10.25 Luminous flux luminaire 1688 lm
06.1616.40A 06.1616.14A			
L: 2500 mm			Beam Angle: 91° h(m) E(l) D(m) 1 910 2.05 2 227 4.10 3 101 6.15 4 57 8.20 5 36 10.25 Luminous flux luminaire 2109 lm
06.1617.40A 06.1617.14A			
L: 3000 mm			Beam Angle: 91° h(m) E(l) D(m) 1 1091 2.05 2 273 4.10 3 121 6.15 4 68 8.20 5 44 10.25 Luminous flux luminaire 2531 lm
06.1618.40A 06.1618.14A			

Intermediate Profiles

L: 1000 mm			Beam Angle: 91° h(m) E(l) D(m) 1 364 2.05 2 91 4.10 3 40 6.15 4 23 8.20 5 15 10.25 Luminous flux luminaire 844 lm
06.1619.40A 06.1619.14A			
L: 1500 mm			Beam Angle: 91° h(m) E(l) D(m) 1 546 2.05 2 136 4.10 3 61 6.15 4 34 8.20 5 22 10.25 Luminous flux luminaire 1266 lm
06.1620.40A 06.1620.14A			
L: 2000 mm			Beam Angle: 91° h(m) E(l) D(m) 1 728 2.05 2 182 4.10 3 81 6.15 4 45 8.20 5 29 10.25 Luminous flux luminaire 1688 lm
06.1621.40A 06.1621.14A			
L: 2500 mm			Beam Angle: 91° h(m) E(l) D(m) 1 910 2.05 2 227 4.10 3 101 6.15 4 57 8.20 5 36 10.25 Luminous flux luminaire 2109 lm
06.1622.40A 06.1622.14A			
L: 3000 mm			Beam Angle: 91° h(m) E(l) D(m) 1 1091 2.05 2 273 4.10 3 121 6.15 4 68 8.20 5 44 10.25 Luminous flux luminaire 2531 lm
06.1623.40A 06.1623.14A			

90° Winkel.
Nicht bespeist. Beinhaltet 1
Aufhängungsset mit Kabel.

90° Corner.
Cannot be powered. Includes 1
cable suspension kit.

90



06.1624.40
06.1624.14

THE RUNNING MAGNET SUSPENSION DOWN – PROFILES

Profile

Elektromechanisches Profil für hängende Installationen.
Lineare Profile in zwei Versionen erhältlich: Einspeisungsprofile zum Anschließen an einen Treiber und Zwischenprofile. Beide Versionen haben eine Länge zwischen 1 m und 3 m.
Abdeckungen sind bei den Einspeisungsprofilen enthalten.
Zubehör zum Anschließen (Netz kabel 4,2 m) und Aufhängen (Stahlkabel 4 m) an der Decke bei allen linearen Einspeisungs- oder Zwischenelementen enthalten.
90°-Ecken auf derselben Ebene verfügbar (symmetrisches Element für die linke und rechte Ecke), in den Versionen Surface und Down.
Für den Anschluss an einen Treiber ausgestattet.
Die Innenseite des Profils wird immer in Schwarz geliefert.

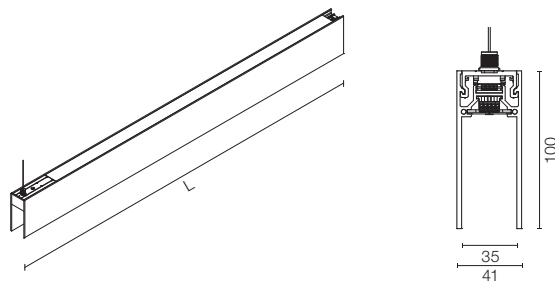

L: 1 m / 1,5 m / 2 m / 2,5 m / 3 m

Profiles

Electromechanical profile for suspended installations.
Linear profiles available in two versions: power feed profiles for connecting to a driver, and intermediate profiles. Both versions available in lengths from 1 m to 3 m.
Covers included with the power feed profiles.
Ceiling connection (4.2 m feed cable) and suspension (4 m steel cable) accessories included in all linear feed or intermediate products. 90° corners in the same plane (symmetrical element for right and left corners) for the Surface and Down versions. Provided for connection to the driver.
The inner part of the profile is always supplied in black.

Feed Unit Profiles

- L: 1000 mm
 - 06.1626.40
 - 06.1626.14
- L: 1500 mm
 - 06.1627.40
 - 06.1627.14
- L: 2000 mm
 - 06.1628.40
 - 06.1628.14
- L: 2500 mm
 - 06.1629.40
 - 06.1629.14
- L: 3000 mm
 - 06.1630.40
 - 06.1630.14

Intermediate Profiles

- L: 1000 mm
 - 06.1631.40
 - 06.1631.14
- L: 1500 mm
 - 06.1632.40
 - 06.1632.14
- L: 2000 mm
 - 06.1633.40
 - 06.1633.14
- L: 2500 mm
 - 06.1634.40
 - 06.1634.14
- L: 3000 mm
 - 06.1635.40
 - 06.1635.14

90° Winkel.

Nicht bespeist. Beinhaltet 1 Aufhängungsset mit Kabel.

Bespeist. Beinhaltet 2 Aufhängungssets mit Kabel.

90° Corner.

Cannot be powered. Includes 1 cable suspension kit.

Can be powered. Includes 2 cable suspension kits.



Cannot be powered

- 06.1657.40
- 06.1657.14

Can be powered

- 06.1656.40
- 06.1656.14

The Running Magnet Suspension Up&Down / Down

Die Einspeisungsprofile werden stets mit Abdeckung geliefert. Abdeckungen müssen nur dann separat bestellt werden, wenn die Installation ausschließlich aus Zwischenprofilen besteht und über die Winkel versorgt wird.

End caps come complete with all the feed unit profiles. These should only be ordered separately if the installation is exclusively composed of intermediate profiles and fed by corners.



- 08.8887.40A
- 08.8887.14A

Für geschlossene Strukturen (Quadrate oder Rechtecke) / Down grid structures (square or rectangle shapes)

90°-Ecke für Gitterstrukturen. Ecke für den Bau von perfekt geschlossenen Gitterstrukturen. Stromversorgungsfähig. Maße 153 x 153.

Corner 90° Grid. Corner to build grid structures perfectly closed. Feed unit. Dimensions 153x153.

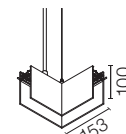

- 06.1740.14

T-Verbindung für Gitterstrukturen. T-Stück für den Bau von perfekt geschlossenen Gitterstrukturen. Stromversorgungsfähig. Maße 265 x 153.

T-Joint Grid Down. T piece to build grid structures perfectly closed. Feed unit. Dimensions 265x153.

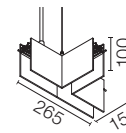

- 06.1741.14

X-Verbindung für Gitterstrukturen. X-Stück für den Bau von perfekt geschlossenen Gitterstrukturen. Stromversorgungsfähig. Maße 265 x 265.

X-Joint Grid Down. Cross piece to build grid structures perfectly closed. Feed unit. Dimensions 265x265.

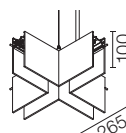

- 06.1742.14

THE RUNNING MAGNET SUSPENSION

Zubehör / Accessories

Einspeisungsrosette zur Oberflächenmontage. Ausrüstung, Netzkabel und Aufhängekabel nicht enthalten, bitte separat bestellen.

Surface rose. Equipment, power cable and suspension cable not included. They must be ordered separately.



08.8883.40A
08.8883.14A

Nichtverdeckte Leistungsbox für direktes sowie direktes und indirektes Licht mit Spannungszufuhr für Driver. 24V/185W - 110/240V -Gerät im Lieferumfang enthalten. Kabel nicht enthalten.

Surface power supply for direct and indirect lighting with housing for the driver. 24V/185W - 110/240V equipment included. Cables not included.

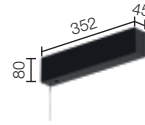

08.8886.40
08.8886.14

Regler DALI und 24V/185W- 110/240V -Gerät zur Einspeisung und Regelung von direkter oder indirekter Beleuchtung im Lieferumfang enthalten. Kabel nicht enthalten.

DALI controller and 24V/185W - 110/240V equipment to supply and control both the direct and indirect lighting, included. Cables not included.

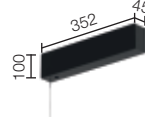

08.8886.40.DA
08.8886.14.DA

Einspeisungsrosette für den versenkten Einbau. Driver nicht im Lieferumfang enthalten, separat bestellen.

Recessed power supply rose. Equipment not included. To be ordered separately.

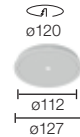

08.8889.40
08.8889.14

THE RUNNING MAGNET – INSTALLATION PROFILES

SUSPENSION INSTALLATION

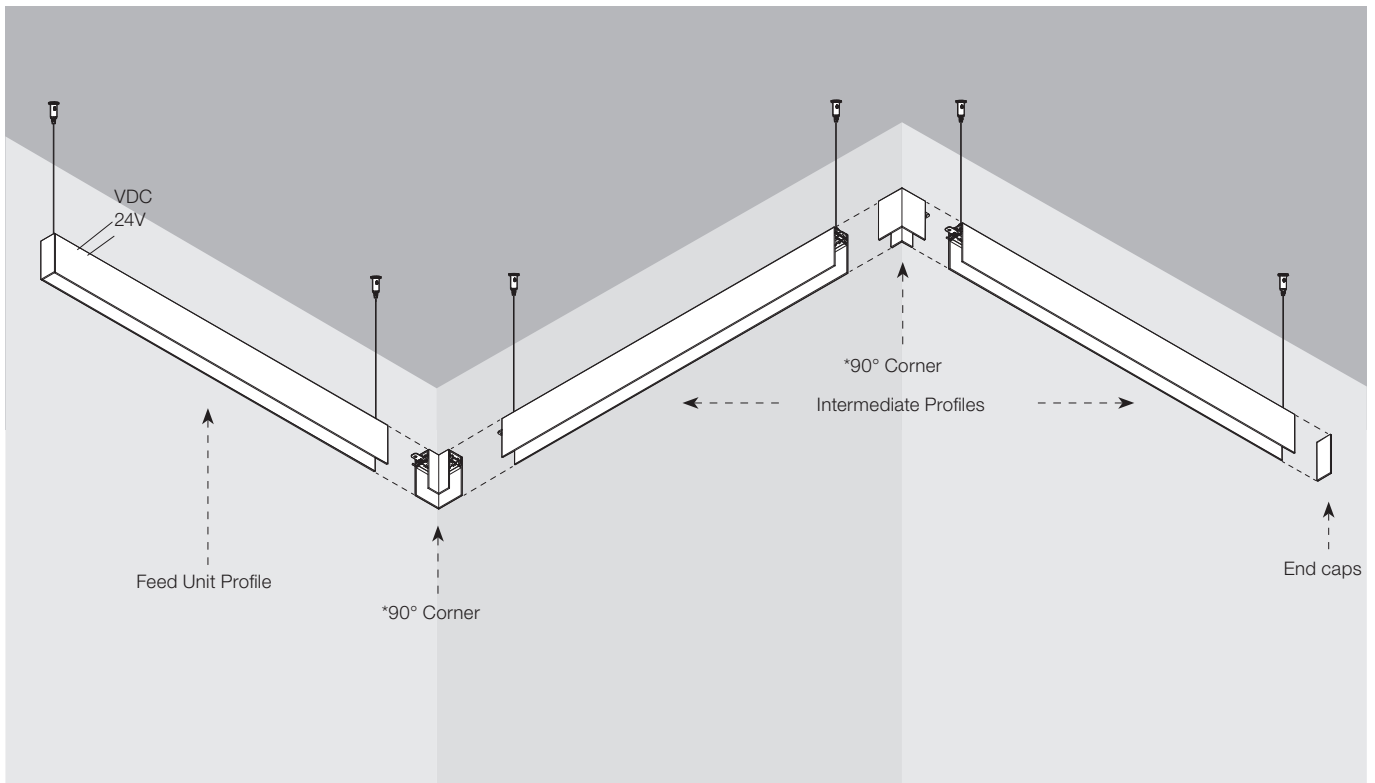

*Winkel für die Einspeisung zur Versorgung der Installation konzipiert, nur in Version DOWN / Corners provided to feed the structure, only in the DOWN version.

THE RUNNING MAGNET – INSTALLATION PROFILES

RECESSED INSTALLATION

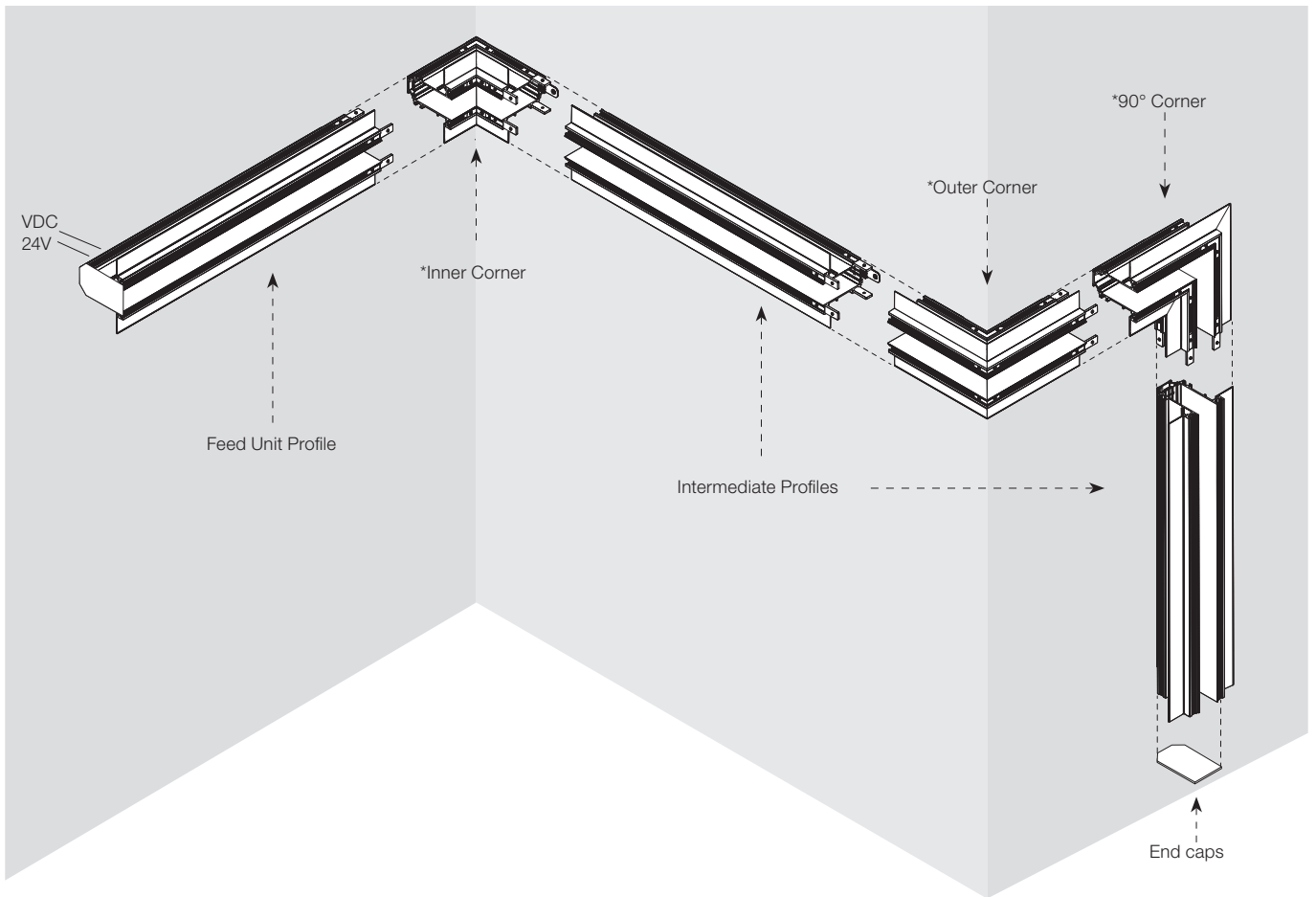

SURFACE INSTALLATION

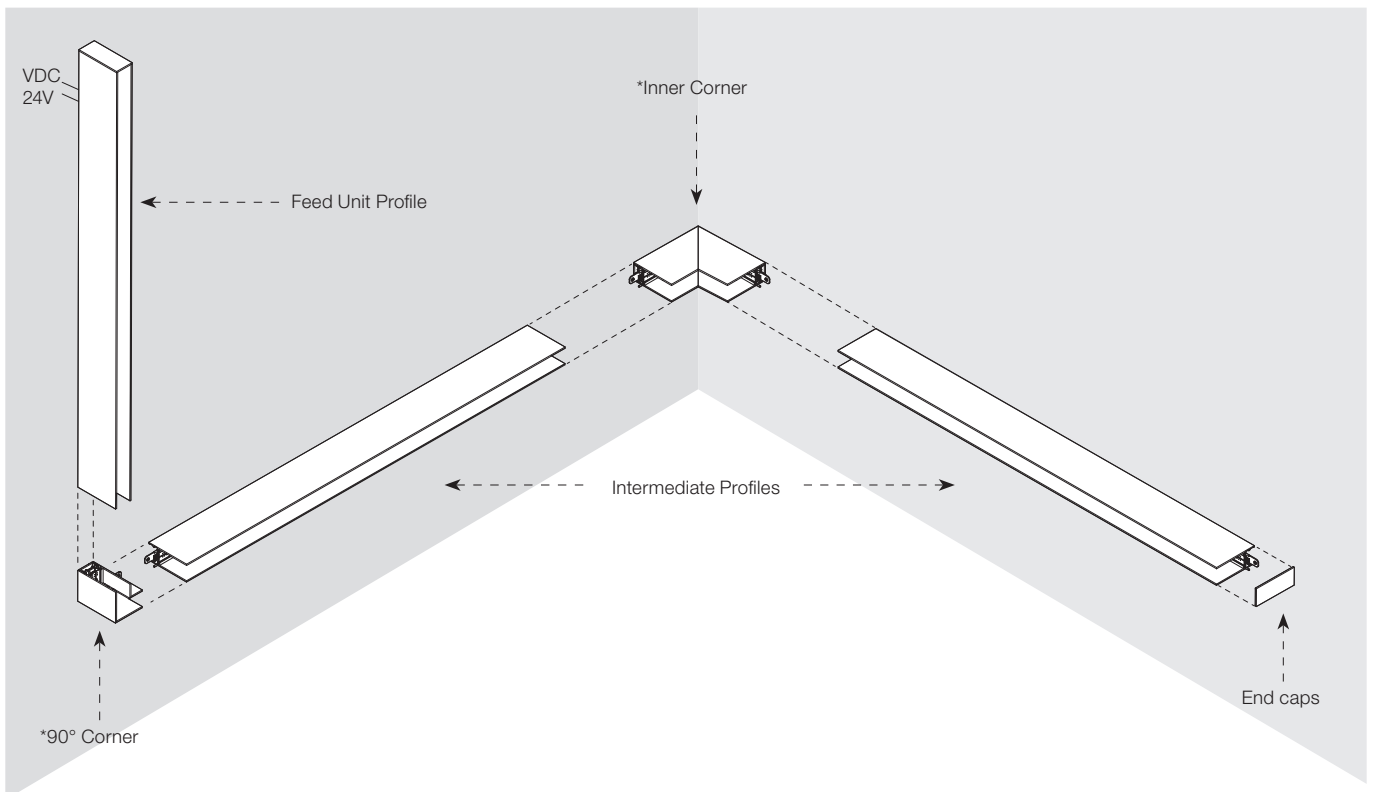

*Winkel für die Einspeisung zur Versorgung der Installation konzipiert / Corners provided to feed the structure.

• Kann die Einspeisung in eine Struktur direkt in einem Winkel ohne Einspeisungsprofil erfolgen?

Ja, die Winkel sind dafür konzipiert, Strukturen in beide Richtungen und ohne Einsatz eines Einspeisungsprofils zu versorgen. Sie müssen nur daran denken, die Abdeckungen der Profile separat zu bestellen, weil diese nicht im Lieferumfang für Winkel und Zwischenprofile enthalten sind. In den Winkeln des Modells Up&Down kann keine Einspeisung erfolgen.

• Kann ein Einspeisungsprofil verwendet werden, um eine auf Putz montierte Struktur von der Mitte her zu versorgen?

Ja, um eine auf Putz montierte Struktur von der Mitte her (in beide Richtungen) zu versorgen, benötigen Sie zwei Einspeisungsprofile mit zwei Netzteilen, d. h. eins für jedes Einspeisungsprofil. Alternativ können Sie unter Berücksichtigung der elektrischen Grenzwerte ein einziges Netzteil für beide Einspeisungsprofile verwenden. Die mechanische Verbindung zwischen den beiden Profilen kann problemlos durchgeführt werden.

• Can I feed a structure directly from a corner without using a feed unit profile?

Yes, corners are prepared to feed a structure in both directions without the need for a feed unit profile. Simply remember that you'll have to order the end cap profiles separately because they are not included in corners and intermediate profiles. Take note that corners in Up&Down versions cannot be fed.

• Can I use a feed unit profile to feed a surface structure from the center?

Yes, to feed a surface structure from the center (in both directions), you'll need to use two feed unit profiles with two power supplies connected, one to each feed unit profile, or connect the same power supply to both feed unit profiles, respecting any potential electrical limitations. The mechanical connection can be made between profiles without any problem.

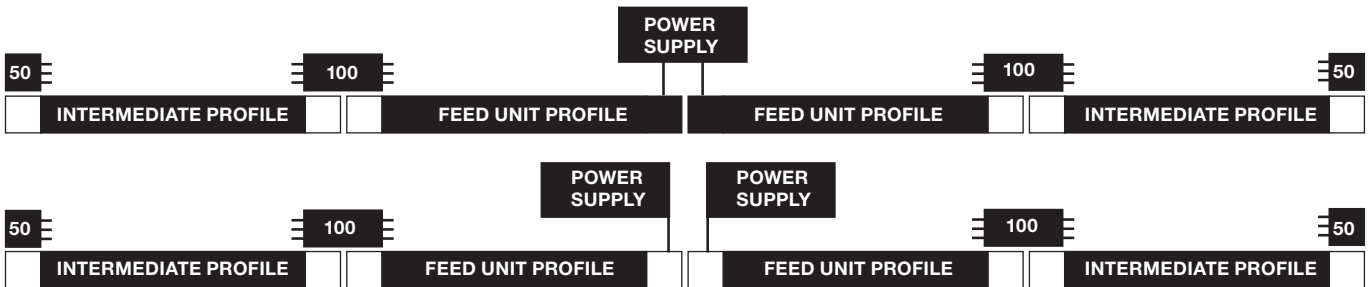

• Können die Profile zugeschnitten werden?

Ja, die Profile können auf die gewünschte Länge zugeschnitten werden (mit Ausnahme des Modells Up&Down). Beachten Sie dabei, dass beim Zerteilen des Profils die Stromkontinuität unterbrochen wird. Wenn das gekürzte Profil nicht das Endstück der Struktur ist und die Stromkontinuität erhalten bleiben soll, muss das nächste Teilprofil erneut über einen Winkel oder ein Einspeisungsprofil versorgt werden. Wenn die Schnittseite am Ende ist, muss die metallene Abdeckung (end cap) elektrisch isoliert werden.

• Can I cut a profile?

Yes, profiles can be cut to the desired length (except Up&Down version). Once a profile is cut, the electrical continuity is lost. If the cut element is not the one that closes the structure (in that case you don't need electrical continuity) the next section must be fed with a corner or a feed unit profile. If the cut side is at the end, the metallic end cap must be electrically insulated.

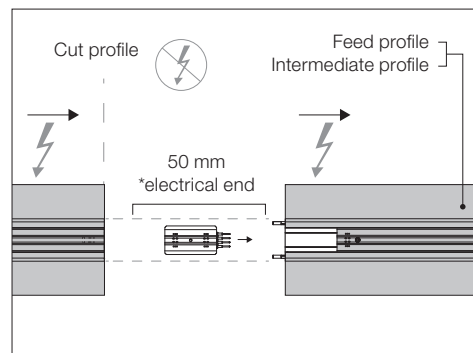
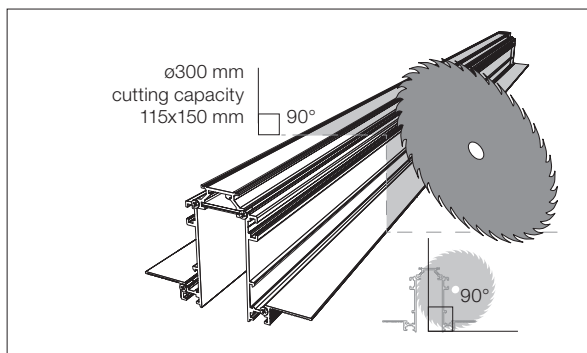

*Im Lieferumfang für Einspeisungsprofile bzw. Endkappen inbegriffen / Included with feed profiles or end caps.

• Können die direkten und indirekten Lichtquellen im Modell Up&Down unabhängig voneinander angesteuert werden?

Ja, um die Lichtquellen für direkte und indirekte Beleuchtung unabhängig voneinander anzusteuern, müssen Sie lediglich ein Netzteil für die direkten als auch für die indirekten Lichtquellen installieren.
Wenn Sie ein DALI Dimmersystem verwenden möchten, müssen Sie das Netzteil der indirekten Lichtquellen mit der Steuereinheit für Dali-Dimmung (60.9678) verbinden.

• Can I independently control the Up Light and the Down Light in the Up&Down version?

Yes, to control the Up Light and Down Light independently you just have to connect one power supply to the down electrical connector and another one to the up electrical connector. This allows you to manage the different light sources independently.
If you want to use a DALI Dimmable system for the Up Light and the Down Light, then the power supply connected to Up Light must be connected to a Dali controller (60.9678).

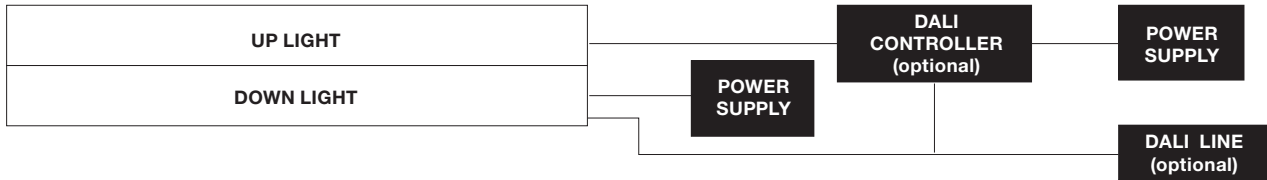

• Können die Lichtquellen in einer mit DALI-Steuerung installierten Struktur unabhängig voneinander angesteuert werden?

Ja, das DALI-System erkennt jede einzelne Leuchte, die installiert wird und ermöglicht deren unabhängige Ansteuerung.

• Can I independently control the luminaires installed in the structure with a DALI controller?

Yes, the DALI system will identify each luminaire installed in the profile with a unique address, and will allow you to independently manage each one.

• Wird die Steuereinheit für Dali-Dimmung 60.9678 für die DALI-Struktur benötigt?

Die Lichtquellen sind bereits mit der DALI-Elektronik ausgerüstet, deshalb ist die DALI-Steuereinheit nicht erforderlich.
Die Steuereinheit für Dali-Dimmung 60.9678 benötigen Sie nur, wenn Sie die indirekte Beleuchtung des Modells Up&Down mit einem DALI-System ansteuern möchten.

• Do I need the Dimmable Dali controller 60.9678 to make the DALI structure?

The luminaries to be installed in the track are already equipped with Dali electronic, so a Dali controller is not required for these.
The 60.9678 DALI Controller is only required to make the Up indirect Light controllable with a DALI system in the Up&Down version.

• Wie hoch ist die maximal zulässige Entfernung zwischen Netzteil und Profil?

Die maximal zulässige Entfernung zum Netzgerät mit 200W (60.9352) aus unserem Katalog beträgt:
. Kabel Ø 1,5 mm² cable: 2,5 m
. Kabel Ø 2,5 mm: 4 m

• What is the maximum distance allowed between the driver and the profile?

With the 200W power supply (60.9352) in our catalogue, the maximum distance allowed is:
. Ø 1.5 mm² cable: 2.5 m
. Ø 2.5 mm² cable: 4 m

• Wie lang darf eine Struktur höchstens sein, damit ein Netzteil sie versorgen kann?

Die maximale Profillänge, die mit einem Netzteil versorgt werden kann, beträgt 8 m.

• What is the maximum length that can be fed with one power supply?

The maximum profile length that can be fed with a power supply is 8 m.

• Ist es möglich, ein weniger leistungsstarkes Netzteil zu verwenden?

Alle Informationen auf unserer Website, in unserem Katalog und den Installationsanleitungen basieren auf Tests mit unserem Netzgerät 200W (60.9352), das für unsere Produkte empfohlen wird.
Unter Berücksichtigung der elektrischen Grenzwerte können Sie allerdings auch ein anderes Netzteil für die Versorgung der Profile verwenden. Dabei muss es sich um ein Netzteil mit 24 V und einer Stromstärke von höchstens 8 A handeln.

• Can I use a different, less powerful power supply?

All the information published on our website, and in our catalogue and installation instructions sheets is adjusted to the tests we perform with our 200W power supply (60.9352), which we recommend for our products. However, a different power supply can be used to feed the profiles but the electrical limitations that it will have to accomplish should be taken into account.
It should be a 24V power supply with a maximum electric current of 8A.

THE RUNNING MAGNET – LIGHT MODULES

Light Stripe

Light Source: Top LED 25W/m - 2060 lm/m - 2700K/CRI 90 / 25W/m - 2178 lm/m - 3000K/CRI 90

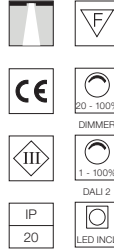
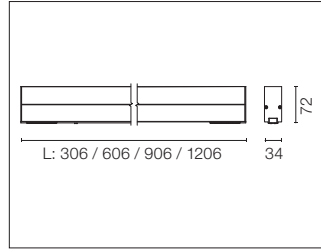

LED-Modul für diffuses Licht zur Installation in das System The Running Magnet. Inklusive Opaglasabdeckungen für kontinuierliche Lichtstreifen. Für die kabellose Steuerung der Leuchten sind die integrierten Casambi-Versionen auszuwählen.

Diffused LED light module to be installed in The Running Magnet System. Opaline end caps to create continuous lines of light included. For wireless lighting control, choose integrated Casambi versions.

2700K

L: 300 mm - 7,5W - 618lm
On board dimmer

03.7000.14

Dali Version

03.7000.14ADA

**Casambi Integrated

03.7000.14.CB

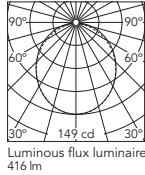

Beam Angle: 105°

h(m) E(lx) D(m)

1 149 2.76

2 37 5.52

3 17 8.28

4 9 11.04

5 6 13.81

3000K

L: 300 mm - 7,5W - 653lm
On board dimmer

03.7001.14

Dali Version

03.7001.14ADA

**Casambi Integrated

03.7001.14.CB

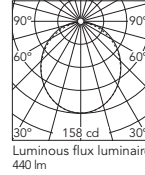

Beam Angle: 105°

h(m) E(lx) D(m)

1 158 2.76

2 39 5.52

3 18 8.28

4 10 11.04

5 6 13.81

2700K

L: 600 mm - 15W - 1237lm
On board dimmer

03.7002.14

Dali Version

03.7002.14ADA

**Casambi Integrated

03.7002.14.CB

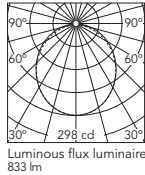

Beam Angle: 105°

h(m) E(lx) D(m)

1 298 2.76

2 75 5.52

3 33 8.28

4 19 11.04

5 12 13.81

3000K

L: 600 mm - 15W - 1307lm
On board dimmer

03.7003.14

Dali Version

03.7003.14ADA

**Casambi Integrated

03.7003.14.CB

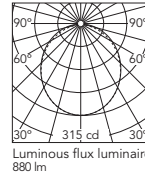

Beam Angle: 105°

h(m) E(lx) D(m)

1 315 2.76

2 79 5.52

3 35 8.28

4 20 11.04

5 13 13.81

2700K

On board dimmer
L: 900 mm - 22,5W - 1855lm

03.7004.14

Dali Version

03.7004.14ADA

**Casambi Integrated

03.7004.14.CB

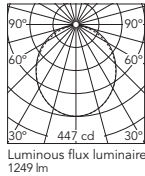

Beam Angle: 105°

h(m) E(lx) D(m)

1 447 2.76

2 112 5.52

3 50 8.28

4 28 11.04

5 18 13.81

3000K

On board dimmer
L: 900 mm - 22,5W - 1960lm

03.7005.14

Dali Version

03.7005.14ADA

**Casambi Integrated

03.7005.14.CB

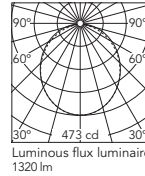

Beam Angle: 105°

h(m) E(lx) D(m)

1 473 2.76

2 118 5.52

3 53 8.28

4 30 11.04

5 19 13.81

2700K

On board dimmer
L: 1200 mm - 30W - 2473lm

03.7006.14

Dali Version

03.7006.14ADA

**Casambi Integrated

03.7006.14.CB

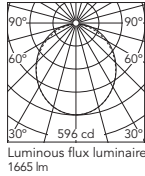

Beam Angle: 105°

h(m) E(lx) D(m)

1 596 2.76

2 149 5.52

3 66 8.28

4 37 11.04

5 24 13.81

3000K

On board dimmer
L: 1200 mm - 30W - 2614lm

03.7007.14

Dali Version

03.7007.14ADA

**Casambi Integrated

03.7007.14.CB

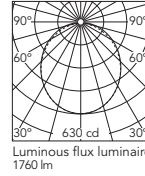

Beam Angle: 105°

h(m) E(lx) D(m)

1 630 2.76

2 158 5.52

3 70 8.28

4 39 11.04

5 25 13.81

** Die Steuerung bei den Casambi-Leuchten erfolgt direkt und individuell kabellos mittels der App FLOS Control® powered by Casambi / The control system with the Casambi version of light fixtures is directly and individually regulated wirelessly using the application FLOS Control® by Casambi.

THE RUNNING MAGNET – LIGHT MODULES

Spot Module

Light Source: Power LED 8W - 560 lm - 2700K/CRI 90 / 8W - 600 lm - 3000K/CRI 90

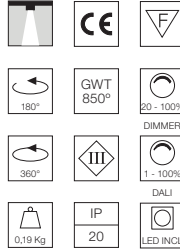
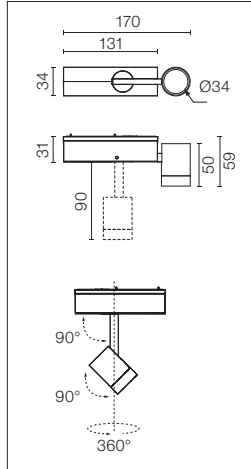

LED-Modul für Akzentbeleuchtung zur Installation in das System The Running Magnet. Elektronischer DC/DC-Wandler enthalten. Für die kabellose Steuerung der Leuchten sind die integrierten Casambi-Versionen auszuwählen.

Accent lighting LED module to be installed in The Running Magnet System. Built-in DC/DC electronic voltage converter. For wireless lighting control, choose integrated Casambi versions.

Spot Module No DALI:
Maximal 21 Spots auf einen Driver.
Spot Module DALI:
Maximal 14 Spots auf einen Driver.

Spot Module No DALI:
Maximum 21 spots for a single driver.
Spot Module DALI:
Maximum 14 spots for a single driver.

Maximal 64 Spots auf einen DALI-Regler.

Maximum 64 spots for a single DALI controller.

Siehe erhältliches Zubehör.

See available accessories.

2700K

On board dimmer

■ 03.6303.14B

Dali Version

■ 03.6303.14CDA

**Casambi Integrated

■ 03.6303.14BCB

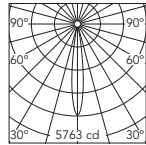

Luminous flux luminaire 403 lm

Beam Angle: 14°

h(m)	E(lx)	D(m)
1	5763	0.24
2	1441	0.49
3	640	0.73
4	360	0.98
5	231	1.22

3000K

On board dimmer

■ 03.6302.14B

Dali Version

■ 03.6302.14CDA

**Casambi Integrated

■ 03.6302.14BCB

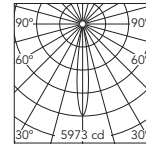

Luminous flux luminaire 418 lm

Beam Angle: 14°

h(m)	E(lx)	D(m)
1	5973	0.24
2	1493	0.49
3	664	0.73
4	373	0.98
5	239	1.22

Zubehör / Accessories

Spot Module

Abschirmender Außenring für Spot-Modul Running Magnet aus Aluminium in Schwarz für einen besseren Sehkomfort.

Screening external ring for Running Magnet spot module in aluminium with a black finish to enhance the visual comfort.



08.8427.14

** Die Steuerung bei den Casambi-Leuchten erfolgt direkt und individuell kabellos mittels der App FLOS Control® powered by Casambi / The control system with the Casambi version of light fixtures is directly and individually regulated wirelessly using the application FLOS Control® by Casambi.

THE RUNNING MAGNET – LIGHT MODULES

Multi Spot 4

Light Source: Power LED 10W - 4x226 lm - 2700K/CRI 90 / 10W - 4x240 lm - 3000K/CRI 90

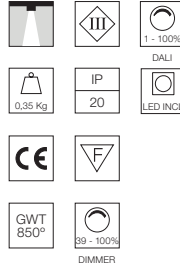
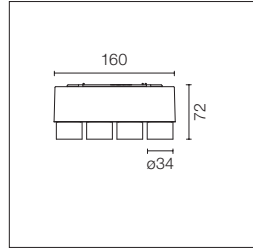

LED-Modul für Akzentbeleuchtung zur Installation in das System The Running Magnet. Elektronischer DC/DC-Wandler enthalten. Für die kabellose Steuerung der Leuchten sind die integrierten Casambi-Versionen auszuwählen.

Accent lighting LED module to be installed in The Running Magnet System. Built-in DC/DC electronic voltage converter. For wireless lighting control, choose integrated Casambi versions.

Siehe erhältliches Zubehör.

See available accessories.

- 2700K**
On board dimmer
03.6305.14
Dali Version
03.6305.14ADA
**Casambi Integrated
03.6305.14.CB

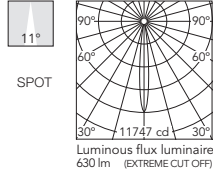

h(m)	E(lx)	D(m)
1	11747	0.20
2	2937	0.40
3	1305	0.60
4	734	0.80
5	470	1.00

- 3000K**
On board dimmer
03.6306.14
Dali Version
03.6306.14ADA
**Casambi Integrated
03.6306.14.CB

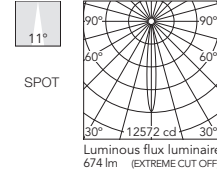

h(m)	E(lx)	D(m)
1	12572	0.20
2	3143	0.40
3	1397	0.60
4	786	0.80
5	503	1.00

Zubehör / Accessories

Spot Module & Multi Spot 4

Linse frosted medium.
Optik-Zubehör medium.



08.8760.00

Frosted medium lens.
Medium lens accessory.

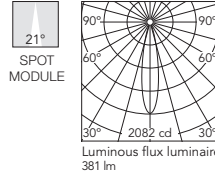

h(m)	E(lx)	D(m)
1	2082	0.36
2	520	0.73
3	231	1.09
4	130	1.46
5	83	1.82

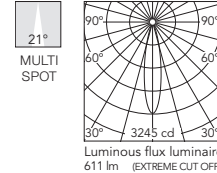

h(m)	E(lx)	D(m)
1	3245	0.37
2	811	0.75
3	361	1.12
4	203	1.50
5	130	1.87

Linse frosted flood.
Optik-Zubehör flood.



08.8761.00

Frosted flood lens.
Flood lens accessory.

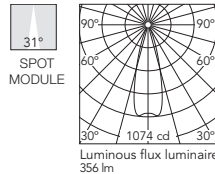

h(m)	E(lx)	D(m)
1	1074	0.55
2	269	1.09
3	119	1.64
4	67	2.19
5	43	2.73

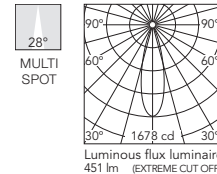

h(m)	E(lx)	D(m)
1	1678	0.50
2	420	1.00
3	186	1.51
4	105	2.01
5	67	2.51

Elliptische linse.



08.8759.00

Elliptical lens.

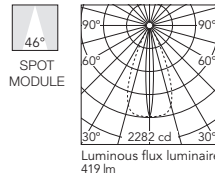

h(m)	E(lx)	D(m)
1	2282	0.17
2	571	0.34
3	254	0.51
4	143	0.68
5	91	0.85

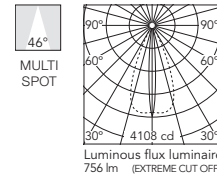

h(m)	E(lx)	D(m)
1	4108	0.15
2	1027	0.30
3	456	0.44
4	257	0.59
5	164	0.74

** Die Steuerung bei den Casambi-Leuchten erfolgt direkt und individuell kabellos mittels der App FLOS Control® powered by Casambi / The control system with the Casambi version of light fixtures is directly and individually regulated wirelessly using the application FLOS Control® by Casambi.

THE RUNNING MAGNET – LIGHT MODULES

Spot 120

Light Source: Power LED 12,5W/14W DALI - 985 lm - 2700K/CRI 90 / 12,5W/14W DALI - 1060 lm - 3000K/CRI 90

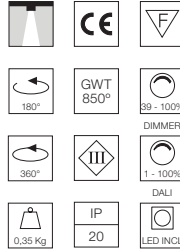
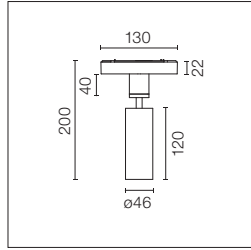

LED-Modul für Akzentbeleuchtung zur Installation in das System The Running Magnet. Elektronischer DC/DC-Wandler enthalten. Für die kabellose Steuerung der Leuchten sind die integrierten Casambi-Versionen auszuwählen.

Accent lighting LED module to be installed in The Running Magnet System. Built-in DC/DC electronic voltage converter. For wireless lighting control, choose integrated Casambi versions.

Spot Module No DALI:
Maximal 14 Spots auf einen Driver.
Spot Module DALI:
Maximal 11 Spots auf einen Driver.

Spot Module No DALI:
Maximum 14 spots for a single driver.
Spot Module DALI:
Maximum 11 spots for a single driver.

Inkludiertes Zubehör (Honeycomb und Blendschutzgitter).

Accessories included (honeycomb and screening crosspiece).

2700K

On board dimmer

- ☐ 03.6285.40
- 03.6285.14

Dali Version

- ☐ 03.6285.40ADA
- 03.6285.14ADA

**Casambi Integrated

- ☐ 03.6285.40.CB
- 03.6285.14.CB

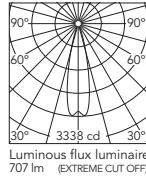

Beam Angle: 25°

h(m)	E(lx)	D(m)
1	3338	0.44
2	835	0.89
3	371	1.33
4	209	1.78
5	134	2.22

Luminous flux luminaire
707 lm (EXTREME CUT OFF)

3000K

On board dimmer

- ☐ 03.6284.40
- 03.6284.14

Dali Version

- ☐ 03.6284.40ADA
- 03.6284.14ADA

**Casambi Integrated

- ☐ 03.6284.40.CB
- 03.6284.14.CB

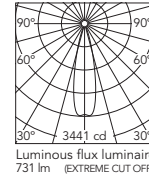

Beam Angle: 25°

h(m)	E(lx)	D(m)
1	3441	0.45
2	860	0.89
3	382	1.34
4	215	1.78
5	138	2.23

Luminous flux luminaire
731 lm (EXTREME CUT OFF)

2700K

On board dimmer

- ☐ 03.6286.40
- 03.6286.14

Dali Version

- ☐ 03.6286.40ADA
- 03.6286.14ADA

**Casambi Integrated

- ☐ 03.6286.40.CB
- 03.6286.14.CB

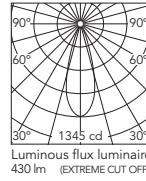

Beam Angle: 33°

h(m)	E(lx)	D(m)
1	1345	0.59
2	336	1.17
3	149	1.76
4	84	2.34
5	54	2.93

Luminous flux luminaire
430 lm (EXTREME CUT OFF)

3000K

On board dimmer

- ☐ 03.6287.40
- 03.6287.14

Dali Version

- ☐ 03.6287.40ADA
- 03.6287.14ADA

**Casambi Integrated

- ☐ 03.6287.40.CB
- 03.6287.14.CB

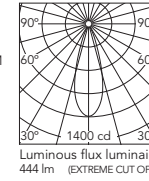

Beam Angle: 33°

h(m)	E(lx)	D(m)
1	1400	0.58
2	350	1.16
3	156	1.75
4	88	2.33
5	56	2.91

Luminous flux luminaire
444 lm (EXTREME CUT OFF)

** Die Steuerung bei den Casambi-Leuchten erfolgt direkt und individuell kabellos mittels der App FLOS Control® powered by Casambi / The control system with the Casambi version of light fixtures is directly and individually regulated wirelessly using the application FLOS Control® by Casambi.

Light Shadow

Light Source: Power LED 10,8W - 4x270 lm - 2700K/CRI 90 / 10,8W - 4x285 lm - 3000K/CRI 90

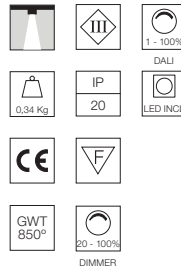
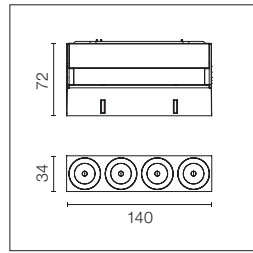

LED-Beleuchtungsmodul mit 4 Scheinwerfern und geringer Blendung für den Einbau in das System The Running Magnet. Elektronischer Stromwandler DC/DC, eingebaut. Für die kabellose Steuerung der Leuchten sind die integrierten Casambi-Versionen auszuwählen.

LED lighting module, with 4 spotlights and low glare, to be installed in the The Running Magnet system. DC/DC, built-in electronic current converter. For wireless lighting control, choose integrated Casambi versions.

E= External Finish
I= Internal Finish

E= Außenfarbe
I= Innenfarbe

Optic Spot 2700K

- E I On board dimmer
- 03.8948.40A
- 03.8948.14A
- E I Dali Version
- 03.8948.40BDA
- 03.8948.14BDA
- E I **Casambi Integrated
- 03.8948.40ACB
- 03.8948.14ACB

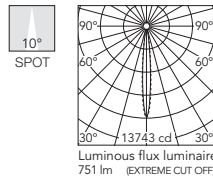

h(m)	E(lx)	D(m)
1	13743	0.17
2	3436	0.35
3	1527	0.52
4	859	0.70
5	550	0.87

Optic Spot 3000K

- E I On board dimmer
- 03.8952.40A
- 03.8952.14A
- E I Dali Version
- 03.8952.40BDA
- 03.8952.14BDA
- E I **Casambi Integrated
- 03.8952.40ACB
- 03.8952.14ACB

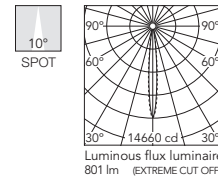

h(m)	E(lx)	D(m)
1	14660	0.17
2	3665	0.35
3	1629	0.52
4	916	0.70
5	586	0.87

2700K

- E I On board dimmer
- 03.8949.40A
- 03.8949.14A
- E I Dali Version
- 03.8949.40BDA
- 03.8949.14BDA
- E I **Casambi Integrated
- 03.8949.40ACB
- 03.8949.14ACB

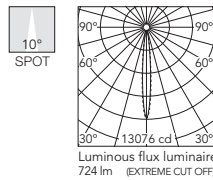

h(m)	E(lx)	D(m)
1	13076	0.18
2	3269	0.36
3	1453	0.54
4	817	0.72
5	523	0.90

3000K

- E I On board dimmer
- 03.8953.40A
- 03.8953.14A
- E I Dali Version
- 03.8953.40BDA
- 03.8953.14BDA
- E I **Casambi Integrated
- 03.8953.40ACB
- 03.8953.14ACB

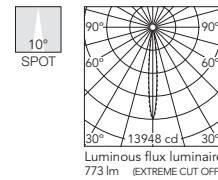

h(m)	E(lx)	D(m)
1	13948	0.18
2	3487	0.36
3	1550	0.54
4	872	0.72
5	558	0.90

2700K

- E I On board dimmer
- 05.1800.40A
- 05.1800.14A
- E I Dali Version
- 05.1800.40ADA
- 05.1800.14ADA
- E I **Casambi Integrated
- 05.1800.40ACB
- 05.1800.14ACB

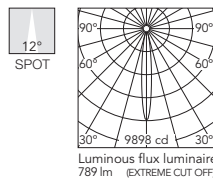

h(m)	E(lx)	D(m)
1	9898	0.22
2	2475	0.44
3	1100	0.66
4	618	0.88
5	396	1.09

3000K

- E I On board dimmer
- 05.1805.40A
- 05.1805.14A
- E I Dali Version
- 05.1805.40ADA
- 05.1805.14ADA
- E I **Casambi Integrated
- 05.1805.40ACB
- 05.1805.14ACB

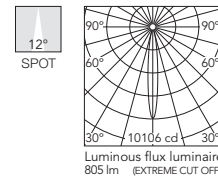

h(m)	E(lx)	D(m)
1	10106	0.22
2	2527	0.44
3	1123	0.66
4	631	0.88
5	404	1.09

2700K

- E I On board dimmer
- 05.1801.40A
- 05.1801.14A
- E I Dali Version
- 05.1801.40ADA
- 05.1801.14ADA
- E I **Casambi Integrated
- 05.1801.40ACB
- 05.1801.14ACB

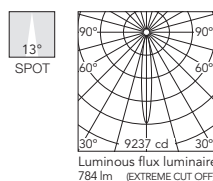

h(m)	E(lx)	D(m)
1	9237	0.23
2	2309	0.45
3	1027	0.68
4	578	0.90
5	370	1.13

3000K

- E I On board dimmer
- 05.1806.40A
- 05.1806.14A
- E I Dali Version
- 05.1806.40ADA
- 05.1806.14ADA
- E I **Casambi Integrated
- 05.1806.40ACB
- 05.1806.14ACB

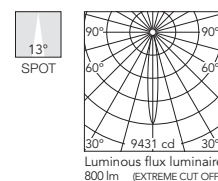

h(m)	E(lx)	D(m)
1	9431	0.23
2	2358	0.45
3	1048	0.68
4	590	0.90
5	378	1.13

2700K

- E I On board dimmer
- 05.1802.40A
- 05.1802.14A
- E I Dali Version
- 05.1802.40ADA
- 05.1802.14ADA
- E I **Casambi Integrated
- 05.1802.40ACB
- 05.1802.14ACB

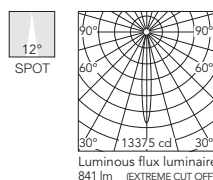

h(m)	E(lx)	D(m)
1	13375	0.20
2	3344	0.41
3	1486	0.61
4	836	0.82
5	535	1.02

3000K



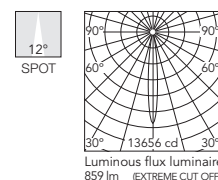





- E I On board dimmer
- 05.1807.40A
- 05.1807.14A
- E I Dali Version
- 05.1807.40ADA
- 05.1807.14ADA
- E I **Casambi Integrated
- 05.1807.40ACB
- 05.1807.14ACB



h(m)	E(lx)	D(m)
1	13656	0.20
2	3414	0.41
3	1517	0.61
4	853	0.82
5	546	1.02

** Die Steuerung bei den Casambi-Leuchten erfolgt direkt und individuell kabellos mittels der App FLOS Control® powered by Casambi / The control system with the Casambi version of light fixtures is directly and individually regulated wirelessly using the application FLOS Control® by Casambi.

**Optic Medium
2700K**



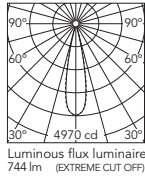





-  On board dimmer
-  03.9620.40A
-  03.9620.14A
-  Dali Version
-  03.9620.40BDA
-  03.9620.14BDA
-  **Casambi Integrated
-  03.9620.40ACB
-  03.9620.14ACB



Beam Angle: 22°

h(m)	E(lx)	D(m)
1	4970	0.39
2	1243	0.78
3	552	1.17
4	311	1.56
5	199	1.95

**Optic Medium
3000K**



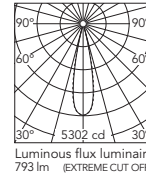





-  On board dimmer
-  03.9630.40A
-  03.9630.14A
-  Dali Version
-  03.9630.40BDA
-  03.9630.14BDA
-  **Casambi Integrated
-  03.9630.40ACB
-  03.9630.14ACB



Beam Angle: 22°

h(m)	E(lx)	D(m)
1	5302	0.39
2	1325	0.78
3	589	1.17
4	331	1.56
5	212	1.95

2700K



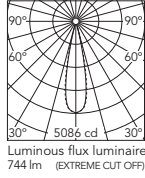





-  On board dimmer
-  03.9621.40A
-  03.9621.14A
-  Dali Version
-  03.9621.40BDA
-  03.9621.14BDA
-  **Casambi Integrated
-  03.9621.40ACB
-  03.9621.14ACB



Beam Angle: 22°

h(m)	E(lx)	D(m)
1	5086	0.39
2	1272	0.78
3	565	1.17
4	318	1.56
5	203	1.95

3000K



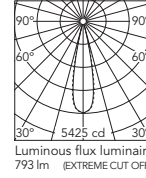





-  On board dimmer
-  03.9631.40A
-  03.9631.14A
-  Dali Version
-  03.9631.40BDA
-  03.9631.14BDA
-  **Casambi Integrated
-  03.9631.40ACB
-  03.9631.14ACB



Beam Angle: 22°

h(m)	E(lx)	D(m)
1	5425	0.39
2	1356	0.78
3	603	1.17
4	339	1.56
5	217	1.95

2700K



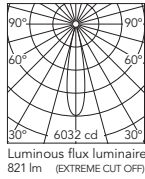





-  On board dimmer
-  05.1810.40A
-  05.1810.14A
-  Dali Version
-  05.1810.40ADA
-  05.1810.14ADA
-  **Casambi Integrated
-  05.1810.40ACB
-  05.1810.14ACB



Beam Angle: 21°

h(m)	E(lx)	D(m)
1	6032	0.37
2	1508	0.74
3	670	1.11
4	377	1.48
5	242	1.84

3000K



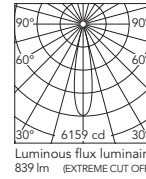





-  On board dimmer
-  05.1815.40A
-  05.1815.14A
-  Dali Version
-  05.1815.40ADA
-  05.1815.14ADA
-  **Casambi Integrated
-  05.1815.40ACB
-  05.1815.14ACB



Beam Angle: 21°

h(m)	E(lx)	D(m)
1	6159	0.37
2	1540	0.74
3	684	1.11
4	385	1.48
5	247	1.84

2700K



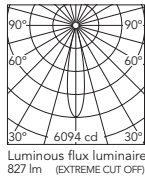





-  On board dimmer
-  05.1811.40A
-  05.1811.14A
-  Dali Version
-  05.1811.40ADA
-  05.1811.14ADA
-  **Casambi Integrated
-  05.1811.40ACB
-  05.1811.14ACB



Beam Angle: 21°

h(m)	E(lx)	D(m)
1	6094	0.36
2	1523	0.73
3	677	1.09
4	381	1.45
5	244	1.81

3000K



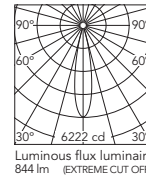





-  On board dimmer
-  05.1816.40A
-  05.1816.14A
-  Dali Version
-  05.1816.40ADA
-  05.1816.14ADA
-  **Casambi Integrated
-  05.1816.40ACB
-  05.1816.14ACB



Beam Angle: 21°

h(m)	E(lx)	D(m)
1	6222	0.36
2	1555	0.73
3	692	1.09
4	389	1.45
5	249	1.81

2700K



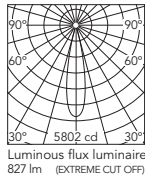





-  On board dimmer
-  05.1812.40A
-  05.1812.14A
-  Dali Version
-  05.1812.40ADA
-  05.1812.14ADA
-  **Casambi Integrated
-  05.1812.40ACB
-  05.1812.14ACB



Beam Angle: 22°

h(m)	E(lx)	D(m)
1	5802	0.38
2	1451	0.76
3	645	1.14
4	363	1.52
5	232	1.91

3000K

-  On board dimmer
-  05.1817.40A
-  05.1817.14A
-  Dali Version
-  05.1817.40ADA
-  05.1817.14ADA
-  **Casambi Integrated
-  05.1817.40ACB
-  05.1817.14ACB

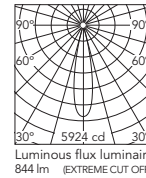

Beam Angle: 22°

h(m)	E(lx)	D(m)
1	5924	0.38
2	1481	0.76
3	658	1.14
4	370	1.52
5	237	1.91

** Die Steuerung bei den Casambi-Leuchten erfolgt direkt und individuell kabellos mittels der App FLOS Control® powered by Casambi / The control system with the Casambi version of light fixtures is directly and individually regulated wirelessly using the application FLOS Control® by Casambi.

THE RUNNING MAGNET – LIGHT MODULES

Light Shadow

Light Source: Power LED 10,8W - 4x270 lm - 2700K/CRI 90 / 10,8W - 4x285 lm - 3000K/CRI 90

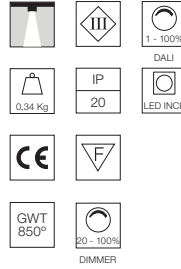
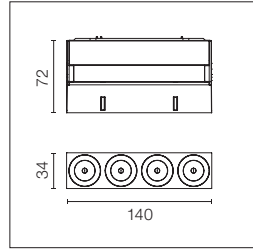

LED-Beleuchtungsmodul mit 4 Scheinwerfern und geringer Blendung für den Einbau in das System The Running Magnet. Elektronischer Stromwandler DC/DC, eingebaut. Für die kabellose Steuerung der Leuchten sind die integrierten Casambi-Versionen auszuwählen.

LED lighting module, with 4 spotlights and low glare, to be installed in the The Running Magnet system. DC/DC, built-in electronic current converter. For wireless lighting control, choose integrated Casambi versions.

E= External Finish
I= Internal Finish

E= Außenfarbe
I= Innenfarbe

Optic Flood 2700K

- E I On board dimmer
- 03.9625.40A
- 03.9625.14A
- E I Dali Version
- 03.9625.40BDA
- 03.9625.14BDA
- E I **Casambi Integrated
- 03.9625.40ACB
- 03.9625.14ACB

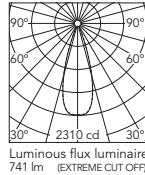

Beam Angle: 33°

h(m)	E(lx)	D(m)
1	2310	0.59
2	577	1.18
3	257	1.78
4	144	2.37
5	92	2.96

Optic Flood 3000K

- E I On board dimmer
- 03.9635.40A
- 03.9635.14A
- E I Dali Version
- 03.9635.40BDA
- 03.9635.14BDA
- E I **Casambi Integrated
- 03.9635.40ACB
- 03.9635.14ACB

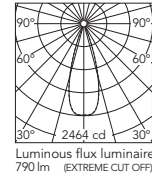

Beam Angle: 33°

h(m)	E(lx)	D(m)
1	2464	0.59
2	616	1.18
3	274	1.78
4	154	2.37
5	99	2.96

2700K

- E I On board dimmer
- 03.9626.40A
- 03.9626.14A
- E I Dali Version
- 03.9626.40BDA
- 03.9626.14BDA
- E I **Casambi Integrated
- 03.9626.40ACB
- 03.9626.14ACB

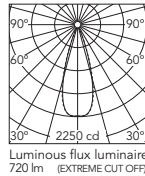

Beam Angle: 33°

h(m)	E(lx)	D(m)
1	2250	0.60
2	563	1.19
3	250	1.79
4	141	2.39
5	90	2.99

3000K

- E I On board dimmer
- 03.9636.40A
- 03.9636.14A
- E I Dali Version
- 03.9636.40BDA
- 03.9636.14BDA
- E I **Casambi Integrated
- 03.9636.40ACB
- 03.9636.14ACB

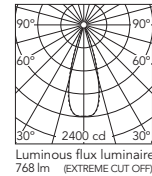

Beam Angle: 33°

h(m)	E(lx)	D(m)
1	2400	0.60
2	600	1.19
3	267	1.79
4	150	2.39
5	96	2.99

2700K

- E I On board dimmer
- 05.1820.40A
- 05.1820.14A
- E I Dali Version
- 05.1820.40ADA
- 05.1820.14ADA
- E I **Casambi Integrated
- 05.1820.40ACB
- 05.1820.14ACB

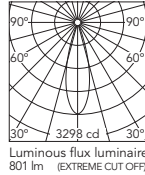

Beam Angle: 29°

h(m)	E(lx)	D(m)
1	3298	0.51
2	824	1.02
3	366	1.53
4	206	2.05
5	132	2.56

3000K

- E I On board dimmer
- 05.1825.40A
- 05.1825.14A
- E I Dali Version
- 05.1825.40ADA
- 05.1825.14ADA
- E I **Casambi Integrated
- 05.1825.40ACB
- 05.1825.14ACB

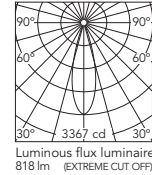

Beam Angle: 29°

h(m)	E(lx)	D(m)
1	3367	0.51
2	842	1.02
3	374	1.53
4	210	2.05
5	135	2.56

2700K

- E I On board dimmer
- 05.1821.40A
- 05.1821.14A
- E I Dali Version
- 05.1821.40ADA
- 05.1821.14ADA
- E I **Casambi Integrated
- 05.1821.40ACB
- 05.1821.14ACB

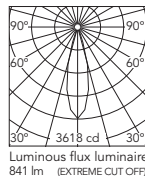

Beam Angle: 27°

h(m)	E(lx)	D(m)
1	3618	0.48
2	904	0.96
3	402	1.43
4	226	1.91
5	145	2.39

3000K

- E I On board dimmer
- 05.1826.40A
- 05.1826.14A
- E I Dali Version
- 05.1826.40ADA
- 05.1826.14ADA
- E I **Casambi Integrated
- 05.1826.40ACB
- 05.1826.14ACB

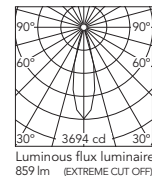

Beam Angle: 27°

h(m)	E(lx)	D(m)
1	3694	0.48
2	923	0.96
3	411	1.43
4	231	1.91
5	148	2.39

2700K

- E I On board dimmer
- 05.1822.40A
- 05.1822.14A
- E I Dali Version
- 05.1822.40ADA
- 05.1822.14ADA
- E I **Casambi Integrated
- 05.1822.40ACB
- 05.1822.14ACB

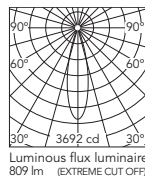

Beam Angle: 26°

h(m)	E(lx)	D(m)
1	3692	0.46
2	923	0.92
3	410	1.39
4	231	1.85
5	148	2.31

3000K

- E I On board dimmer
- 05.1827.40A
- 05.1827.14A
- E I Dali Version
- 05.1827.40ADA
- 05.1827.14ADA
- E I **Casambi Integrated
- 05.1827.40ACB
- 05.1827.14ACB

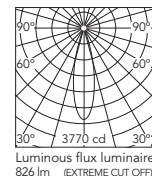

Beam Angle: 26°

h(m)	E(lx)	D(m)
1	3770	0.46
2	942	0.92
3	419	1.39
4	236	1.85
5	151	2.31

** Die Steuerung bei den Casambi-Leuchten erfolgt direkt und individuell kabellos mittels der App FLOS Control® powered by Casambi / The control system with the Casambi version of light fixtures is directly and individually regulated wirelessly using the application FLOS Control® by Casambi.

Optic Wide Flood 2700K

- E I On board dimmer
- 03.9660.40A
- 03.9660.14A
- E I Dali Version
- 03.9660.40BDA
- 03.9660.14BDA
- E I **Casambi Integrated
- 03.9660.40ACB
- 03.9660.14ACB

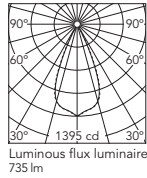

Beam Angle: 47°

h(m)	E(lx)	D(m)
1	1395 0.84	
2	349 1.69	
3	155 2.53	
4	87 3.38	
5	56 4.22	

Optic Wide Flood 3000K

- E I On board dimmer
- 03.9664.40A
- 03.9664.14A
- E I Dali Version
- 03.9664.40BDA
- 03.9664.14BDA
- E I **Casambi Integrated
- 03.9664.40ACB
- 03.9664.14ACB

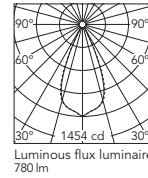

Beam Angle: 47°

h(m)	E(lx)	D(m)
1	1454 0.83	
2	363 1.67	
3	162 2.50	
4	91 3.34	
5	58 4.17	

2700K

- E I On board dimmer
- 03.9661.40A
- 03.9661.14A
- E I Dali Version
- 03.9661.40BDA
- 03.9661.14BDA
- E I **Casambi Integrated
- 03.9661.40ACB
- 03.9661.14ACB

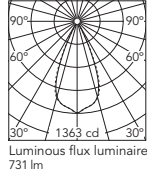

Beam Angle: 47°

h(m)	E(lx)	D(m)
1	1363 0.83	
2	341 1.67	
3	151 2.50	
4	85 3.34	
5	55 4.17	

3000K

- E I On board dimmer
- 03.9665.40A
- 03.9665.14A
- E I Dali Version
- 03.9665.40BDA
- 03.9665.14BDA
- E I **Casambi Integrated
- 03.9665.40ACB
- 03.9665.14ACB

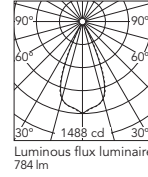

Beam Angle: 47°

h(m)	E(lx)	D(m)
1	1488 0.84	
2	372 1.69	
3	165 2.53	
4	93 3.38	
5	60 4.22	

2700K

- E I On board dimmer
- 05.1830.40A
- 05.1830.14A
- E I Dali Version
- 05.1830.40ADA
- 05.1830.14ADA
- E I **Casambi Integrated
- 05.1830.40ACB
- 05.1830.14ACB

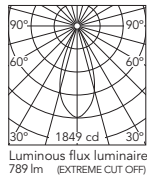

Beam Angle: 41°

h(m)	E(lx)	D(m)
1	1849 0.74	
2	462 1.48	
3	205 2.22	
4	115 2.96	
5	74 3.70	

3000K

- E I On board dimmer
- 05.1835.40A
- 05.1835.14A
- E I Dali Version
- 05.1835.40ADA
- 05.1835.14ADA
- E I **Casambi Integrated
- 05.1835.40ACB
- 05.1835.14ACB

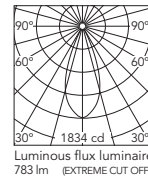

Beam Angle: 41°

h(m)	E(lx)	D(m)
1	1834 0.74	
2	458 1.48	
3	204 2.22	
4	114 2.96	
5	74 3.70	

2700K

- E I On board dimmer
- 05.1831.40A
- 05.1831.14A
- E I Dali Version
- 05.1831.40ADA
- 05.1831.14ADA
- E I **Casambi Integrated
- 05.1831.40ACB
- 05.1831.14ACB

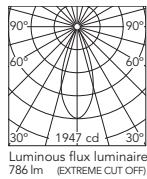

Beam Angle: 38°

h(m)	E(lx)	D(m)
1	1947 0.70	
2	487 1.39	
3	216 2.09	
4	122 2.78	
5	78 3.48	

3000K

- E I On board dimmer
- 05.1836.40A
- 05.1836.14A
- E I Dali Version
- 05.1836.40ADA
- 05.1836.14ADA
- E I **Casambi Integrated
- 05.1836.40ACB
- 05.1836.14ACB

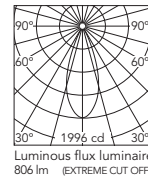

Beam Angle: 38°

h(m)	E(lx)	D(m)
1	1996 0.70	
2	499 1.39	
3	222 2.09	
4	125 2.78	
5	80 3.48	

2700K

- E I On board dimmer
- 05.1832.40A
- 05.1832.14A
- E I Dali Version
- 05.1832.40ADA
- 05.1832.14ADA
- E I **Casambi Integrated
- 05.1832.40ACB
- 05.1832.14ACB

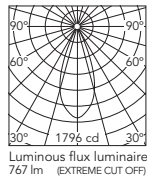

Beam Angle: 41°

h(m)	E(lx)	D(m)
1	1796 0.74	
2	449 1.48	
3	200 2.22	
4	112 2.96	
5	72 3.70	

3000K

- E I On board dimmer
- 05.1837.40A
- 05.1837.14A
- E I Dali Version
- 05.1837.40ADA
- 05.1837.14ADA
- E I **Casambi Integrated
- 05.1837.40ACB
- 05.1837.14ACB

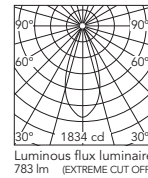

Beam Angle: 41°

h(m)	E(lx)	D(m)
1	1834 0.74	
2	458 1.48	
3	204 2.22	
4	115 2.96	
5	73 3.70	

** Die Steuerung bei den Casambi-Leuchten erfolgt direkt und individuell kabellos mittels der App FLOS Control® powered by Casambi / The control system with the Casambi version of light fixtures is directly and individually regulated wirelessly using the application FLOS Control® by Casambi.

THE RUNNING MAGNET – LIGHT MODULES

Light Shadow Wall-Washer

Light Source: Power LED 10,8W - 4x270 lm - 2700K/CRI 90 / 10,8W - 4x285 lm - 3000K/CRI 90

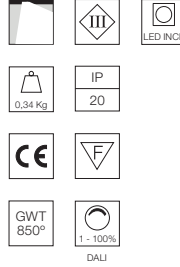
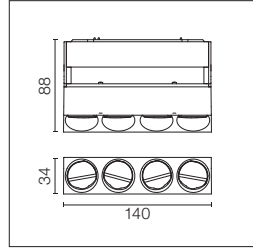

LED-Beleuchtungsmodul mit 4 Scheinwerfern und geringer Blendung für den Einbau in das System The Running Magnet. Elektronischer Stromwandler DC/DC, eingebaut. Für die kabellose Steuerung der Leuchten sind die integrierten Casambi-Versionen auszuwählen.

LED lighting module, with 4 spotlights and low glare, to be installed in the The Running Magnet system. DC/DC, built-in electronic current converter. For wireless lighting control, choose integrated Casambi versions.

2700K

On board dimmer

- 03.9905.40A
- 03.9905.14A

Dali Version

- 03.9905.40BDA
- 03.9905.14BDA

**Casambi Integrated

- 03.9905.40ACB
- 03.9905.14ACB

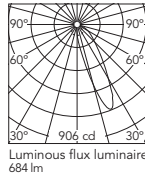

Beam Angle: 46°

h(m)	Ef(lx)	D(m)
1	906	0.48
2	227	0.97
3	101	1.45
4	57	1.94
5	36	2.42

Luminous flux luminaire 684 lm

3000K

On board dimmer

- 03.9904.40A
- 03.9904.14A

Dali Version

- 03.9904.40BDA
- 03.9904.14BDA

**Casambi Integrated

- 03.9904.40ACB
- 03.9904.14ACB

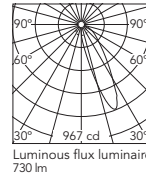

Beam Angle: 46°

h(m)	Ef(lx)	D(m)
1	967	0.48
2	242	0.97
3	107	1.45
4	60	1.94
5	39	2.42

Luminous flux luminaire 730 lm

String Light Sphere

Light Source: Power LED 16W - 1310 lm - 2700K/CRI 90 / 16W - 1404 lm - 3000K/CRI 90

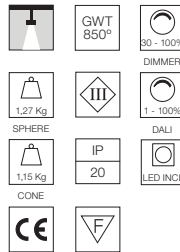
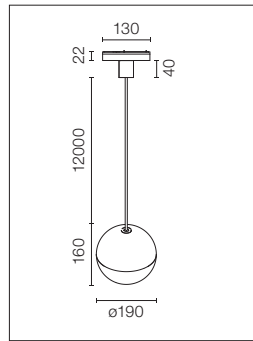

LED-Modul für allgemeine Beleuchtung zur Installation in das System The Running Magnet. Elektronischer DC/DC-Wandler enthalten. Für die kabellose Steuerung der Leuchten sind die integrierten Casambi-Versionen auszuwählen.

General lighting LED module to be installed in The Running Magnet System. Built-in DC/DC electronic voltage converter. For wireless lighting control, choose integrated Casambi versions.

Spot Module No DALI:
Maximal 9 Spots auf einen Driver.

Spot Module No DALI:
Maximum 9 spots for a single driver.

String Light Cone

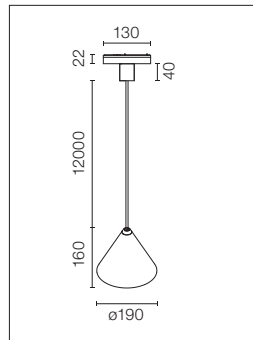

String Light Sphere 2700K

On board dimmer

- 03.6295.14
- 03.6295.14.DA
- **Casambi Integrated
- 03.6295.14.CB

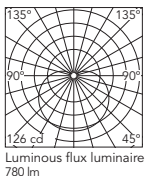

Luminous flux luminaire 780 lm

String Light Sphere 3000K

On board dimmer

- 03.6296.14
- 03.6296.14.DA
- **Casambi Integrated
- 03.6296.14.CB

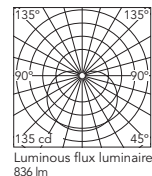

Luminous flux luminaire 836 lm

String Light Cone 2700K

On board dimmer

- 03.6297.14
- 03.6297.14.DA
- **Casambi Integrated
- 03.6297.14.CB

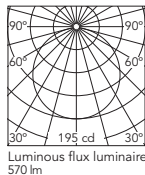

Luminous flux luminaire 570 lm

Beam Angle: 114°

h(m)	Ef(lx)	D(m)
1	195	3.09
2	49	6.17
3	22	9.26
4	12	12.34
5	8	15.43

String Light Cone 3000K

On board dimmer

- 03.6298.14
- 03.6298.14.DA
- **Casambi Integrated
- 03.6298.14.CB

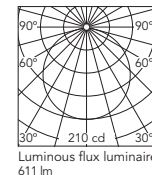

Luminous flux luminaire 611 lm

Beam Angle: 114°

h(m)	Ef(lx)	D(m)
1	210	3.09
2	52	6.17
3	23	9.26
4	13	12.34
5	8	15.43

THE RUNNING MAGNET – LIGHT MODULES

Mini Glo-Ball

Light Source: Power LED 7W - 800 lm - 2700K/CRI 80 / 7W - 880 lm - 3000K/CRI 80

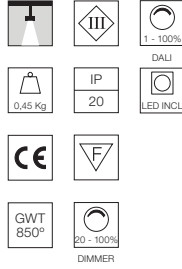
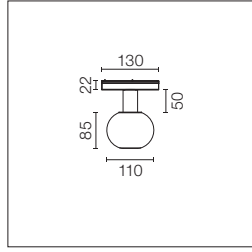

LED-Modul für allgemeine Beleuchtung zur Installation in das System The Running Magnet. Elektronischer DC/DC-Wandler enthalten.

Für die kabellose Steuerung der Leuchten sind die integrierten Casambi-Versionen auszuwählen.

Spot Module No DALI:
Maximal 21 Spots auf einen driver.
Spot Module DALI:
Maximal 14 Spots auf einen driver.

General lighting LED module to be installed in The Running Magnet System. Built-in DC/DC electronic voltage converter. For wireless lighting control, choose integrated Casambi versions.

Spot Module No DALI:
Maximum 21 spots for a single driver.
Spot Module DALI:
Maximum 14 spots for a single driver.

2700K

On board dimmer

- 03.6260.14B
Dali Version
- 03.6260.14ADA
*Casambi Integrated
- 03.6260.14.CB

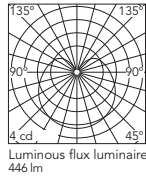

3000K

On board dimmer

- 03.6261.14B
Dali Version
- 03.6261.14ADA
*Casambi Integrated
- 03.6261.14.CB

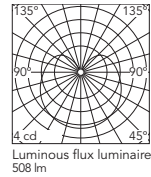

Mini Glo-Ball S

Light Source: Power LED 3,5W - 400 lm - 2700K/CRI 80 / 3,5W - 440 lm - 3000K/CRI 80

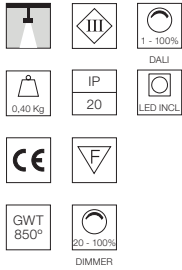
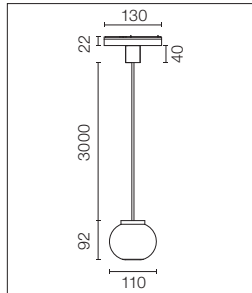

LED-Modul für allgemeine Beleuchtung zur Installation in das System The Running Magnet. Elektronischer DC/DC-Wandler enthalten.

Für die kabellose Steuerung der Leuchten sind die integrierten Casambi-Versionen auszuwählen.

Spot Module No DALI:
Maximal 21 Spots auf einen driver.
Spot Module DALI:
Maximal 14 Spots auf einen driver.

General lighting LED module to be installed in The Running Magnet System. Built-in DC/DC electronic voltage converter. For wireless lighting control, choose integrated Casambi versions.

Spot Module No DALI:
Maximum 21 spots for a single driver.
Spot Module DALI:
Maximum 14 spots for a single driver.

2700K

On board dimmer

- 03.6262.14B
Dali Version
- 03.6262.14ADA
**Casambi Integrated
- 03.6262.14.CB

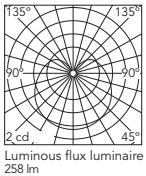

3000K

On board dimmer

- 03.6263.14B
Dali Version
- 03.6263.14ADA
**Casambi Integrated
- 03.6263.14.CB

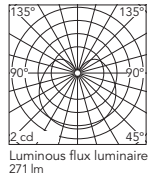

** Die Steuerung bei den Casambi-Leuchten erfolgt direkt und individuell kabellos mittels der App FLOS Control® powered by Casambi / The control system with the Casambi version of light fixtures is directly and individually regulated wirelessly using the application FLOS Control® by Casambi.

THE RUNNING MAGNET – LIGHT MODULES

Find Me 1 Suspension

Light Source: Power LED 8W - 560 lm - 2700K/CRI 90 / 8W - 600 lm - 3000K/CRI 90

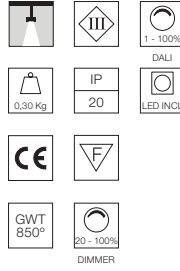
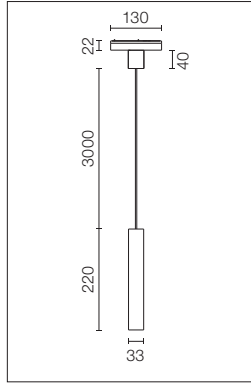

LED-Modul für Akzentbeleuchtung zur Installation in das System The Running Magnet. Elektronischer DC/DC-Wandler enthalten. Für die kabellose Steuerung der Leuchten sind die integrierten Casambi-Versionen auszuwählen.

Accent lighting LED module to be installed in The Running Magnet System. Built-in DC/DC electronic voltage converter. For wireless lighting control, choose integrated Casambi versions.

Spot Module No DALI:
Maximal 21 Spots auf einen driver.
Spot Module DALI:
Maximal 14 Spots auf einen driver.

Spot Module No DALI:
Maximum 21 spots for a single driver.
Spot Module DALI:
Maximum 14 spots for a single driver.

2700K

- On board dimmer
- 03.6272.30D
 - 03.6272.06D
 - 03.6272.14D

Dali Version

- 03.6272.30EDA
- 03.6272.06EDA
- 03.6272.14EDA

**Casambi Integrated

- 03.6272.30DCB
- 03.6272.06DCB
- 03.6272.14DCB

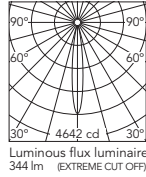

Beam Angle: 14°

h(m)	E(lx)	D(m)
1	4642	0.24
2	1160	0.48
3	516	0.72
4	290	0.95
5	186	1.19

Luminous flux luminaire 344 lm (EXTREME CUT OFF)

3000K

- On board dimmer
- 03.6273.30D
 - 03.6273.06D
 - 03.6273.14D

Dali Version

- 03.6273.30EDA
- 03.6273.06EDA
- 03.6273.14EDA

**Casambi Integrated

- 03.6273.30DCB
- 03.6273.06DCB
- 03.6273.14DCB

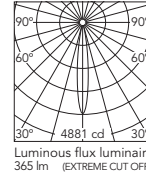

Beam Angle: 14°

h(m)	E(lx)	D(m)
1	4881	0.24
2	1220	0.49
3	542	0.73
4	305	0.97
5	195	1.21

Luminous flux luminaire 365 lm (EXTREME CUT OFF)

Anthony Spot Track By Antonio Citterio

Light Source: Power LED 16W - 1310 lm - 2700K/CRI 90 / 16W - 1404 lm - 3000K/CRI 90

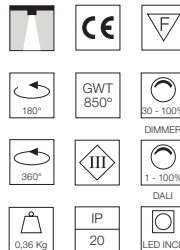
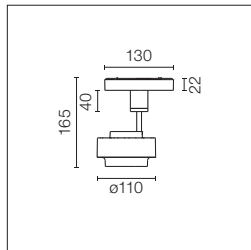

LED-Modul für Akzentbeleuchtung zur Installation in das System The Running Magnet. Elektronischer DC/DC-Wandler enthalten. Für die kabellose Steuerung der Leuchten sind die integrierten Casambi-Versionen auszuwählen.

Accent lighting LED module to be installed in The Running Magnet System. Built-in DC/DC electronic voltage converter. For wireless lighting control, choose integrated Casambi versions.

Spot Module No DALI:
Maximal 9 Spots auf einen Driver.

Spot Module No DALI:
Maximum 9 spots for a single driver.

Siehe erhältliches Zubehör.

See available accessories.

2700K

- On board dimmer
- 03.6277.40A
 - 03.6277.14A

Dali Version

- 03.6277.40ADA
- 03.6277.14ADA

**Casambi Integrated

- 03.6277.40ACB
- 03.6277.14ACB

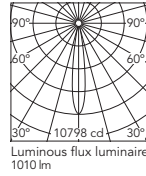

Beam Angle: 15°

h(m)	E(lx)	D(m)
1	10798	0.27
2	2700	0.54
3	1200	0.81
4	675	1.09
5	432	1.36

Luminous flux luminaire 1010 lm

3000K

- On board dimmer
- 03.6274.40A
 - 03.6274.14A

Dali Version

- 03.6274.40ADA
- 03.6274.14ADA

**Casambi Integrated

- 03.6274.40ACB
- 03.6274.14ACB

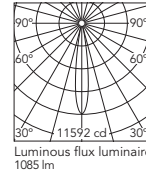

Beam Angle: 15°

h(m)	E(lx)	D(m)
1	11592	0.27
2	2898	0.54
3	1288	0.81
4	724	1.09
5	464	1.36

Luminous flux luminaire 1085 lm

2700K

- On board dimmer
- 03.6278.40A
 - 03.6278.14A

Dali Version

- 03.6278.40ADA
- 03.6278.14ADA

**Casambi Integrated

- 03.6278.40ACB
- 03.6278.14ACB

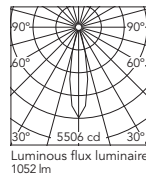

Beam Angle: 22°

h(m)	E(lx)	D(m)
1	5506	0.40
2	1376	0.79
3	612	1.19
4	344	1.58
5	220	1.98

Luminous flux luminaire 1052 lm

3000K

- On board dimmer
- 03.6275.40A
 - 03.6275.14A

Dali Version

- 03.6275.40ADA
- 03.6275.14ADA

**Casambi Integrated

- 03.6275.40ACB
- 03.6275.14ACB

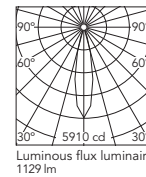

Beam Angle: 22°



h(m)	E(lx)	D(m)
1	5910	0.40
2	1478	0.79
3	657	1.19
4	369	1.58
5	236	1.98

Luminous flux luminaire 1129 lm







** Die Steuerung bei den Casambi-Leuchten erfolgt direkt und individuell kabellos mittels der App FLOS Control® powered by Casambi / The control system with the Casambi version of light fixtures is directly and individually regulated wirelessly using the application FLOS Control® by Casambi.

Zubehör / Accessories

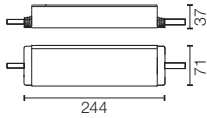

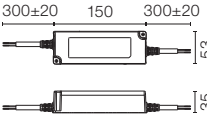
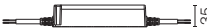
Anthony Spot Track

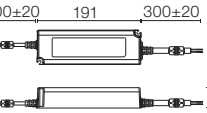
Elliptische linse.	Elliptical lens.		08.8418.68A
Honeycomb.	Honeycomb.		08.8419.14A
Floodlinse. Zum Erreichen von Flood-Optik (35°), Anthony Spot Medium + Flood-Linse bestellen.	Flood lens. To obtain flood optics (35°) order Anthony Spot Medium + flood lens.		08.0050.00

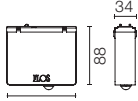
Treiber / Drivers

LED-Netzteil für den Ferneinbau im Verteiler 24V/200W. Um Überlastproblemen vorzubeugen, empfiehlt sich der Einbau eines Netzteils für jeweils 185W. 100/240V.	LED power supply source for remote installation in 24V/200W electric control panel. To avoid problems of overload it is recommended to install a power source every 185W. 100/240V.			60.9352
Elektronischer Transformator für LED mit beständiger Spannung (24V) – 100/240V.	Electronic transformer with constant voltage (24V) for LED. 100/240V.		 	60W 60.9089 Up lighting max 6m
Elektronischer Transformator für LED mit beständiger Spannung (24V) – 100/240V.	Electronic transformer with constant voltage (24V) for LED. 100/240V.		 	120W 60.9407 Up lighting max 8m
Multifunktionales Smart Device. Dreifachfunktionalität 3x1: Casambi Signalverstärker, Lichtsensor und Präsenzmelder. FLOS Control® by Casambi.	Multifunction Smart Device. Triple functionality 3x1: Casambi signal repeater, light sensor and presence detector. FLOS Control® by Casambi.			06.1987.40 06.1987.14

The Running Magnet Up&Down version

Steuereinheit für Dali-Dimmung; für 12 bis 48V-LED-Module; Netzgerät nicht inbegriffen.	Dimmable Dali control unit for 12 to 48V LED modules. Power supply not included.			60.9678
---	--	---	---	---------

Bei der Dimensionierung der Anlage ist eine Sicherheitsspanne von 15 % der maximalen Leistung der LED-Stromversorgung einzuhalten / For the sizing of the installation keep a safety margin of 15% of the maximum power of the LED power source.

THE TRACKING MAGNET

DESIGNED BY FLOS ARCHITECTURAL

FLOS
CONTROL BY CASAMBI



RECESSED

SURFACE

SUSPENSION
UP&DOWN/DOWN



Recessed Profiles 14 Schwarz 14 Black Surface/Suspension Profiles 40 Weiss 40 White 05 Hochglänzendem 05 Polished Aluminium 14 Schwarz 14 Black

LIGHT MODULES

LIGHT STRIPE



LIGHT SOURCE
TOP LED
20W/m
1859 lm/m
2700K/CRI 90
1967 lm/m
3000K/CRI 90

SPOT 50



LIGHT SOURCE
POWER LED
3,5W
286 lm
2700K/CRI 90
307 lm
3000K/CRI 90

SPOT 90



LIGHT SOURCE
POWER LED
8,5W
610 lm
2700K/CRI 90
656 lm
3000K/CRI 90

SPOT 120



LIGHT SOURCE
POWER LED
12W
724 lm
2700K/CRI 90
779 lm
3000K/CRI 90

SPOT 120



LIGHT SOURCE
LED ARRAY
12,5W
1075 lm
2700K/CRI 90
1138 lm
3000K/CRI 90

SPOT 150



LIGHT SOURCE
LED ARRAY
22,5W
2000 lm
2700K/CRI 90
2115 lm
3000K/CRI 90

ANTHONY SPOT TRACK



LIGHT SOURCE
LED ARRAY
16,5W
1620 lm
2700K/CRI 90
1730 lm
3000K/CRI 90

WALLEE



LIGHT SOURCE
TOP LED
10W
773 lm
2700K/CRI 90
818 lm
3000K/CRI 90

WALLEE



LIGHT SOURCE
TOP LED
10W
773 lm
2700K/CRI 90
818 lm
3000K/CRI 90

MULTIFUNCTION SMART DEVICE



FLOS CONTROL®
by Casambi



Surface
Flos Kit
Installation



Recessed
Flos Kit
Installation



Recessed
Conventional
Installation



Anthony Spot

THE TRACKING MAGNET

Produktbeschreibung

Überarbeitetes Beleuchtungssystem für den Innenbereich für Aufputz-, Pendel- oder Einbauinstallationen in Wänden/Decken aus Gipskarton.

Mit dem neuen Angebot geht FLOS neben der bekannten Version "On Board Dimmer" einen Schritt weiter und präsentiert Profile und Leuchten, die mit verschiedenen Fernsteuerungssystemen gesteuert werden können: DALI, 1-10V und Casambi.

Es gibt drei Profilversionen (vertieft, Oberfläche/Aufhängung und Up&Down), alle aus extrudiertem Aluminium mit einer max. Länge von 3 m in Weiß, Schwarz oder poliertem Aluminium, ausgestattet mit elektrischen Schienen, die mit 48 V versorgt werden. Darüber hinaus sind die systemgesteuerten Versionen (DALI, 1-10V) mit einem Datenbus aus Graphit zur Regulierung ausgestattet. Die Leuchten werden mit einem magnetischen Befestigungssystem montiert.

Die Produktgruppe Tracking Magnet wird durch Module mit Umgebungs- und Akzentbeleuchtung in verschiedener Optik ergänzt. Die Lichtmodule verfügen über einen eingebauten Potentiometer und je nach Wunsch über DALI-, 1-10V- oder Casambi-Lichtsteuerung.

Steuerung

- Für Leuchtmontagen mit Dimmer "On Board Dimmer" und FLOS-Steuerung ist das Profil in der Version "On Board Dimmer" zu verwenden. DALI- und 1-10V-Leuchten sind nur mit den Profilversionen DALI und 1-10V kompatibel. Casambi-Leuchten sind mit allen Profilen kompatibel.

- Für die Steuerung mittels DALI-Protokoll muss der Steuerdatenbus direkt mit dem Profil verbunden werden.

- Für die Steuerung mittels 1-10V muss das Steuerungssystem aktiviert sein (SOURCE, die Steuerung erzeugt das Spannungssignal) und der Steuerdatenbus muss direkt mit dem Profil verbunden werden. Wenn es sich um eine passive Steuerung handelt (SINK), ist die Einheit Control Dimming Box erforderlich (diese befindet sich zwischen der Steuereinheit und der Schiene), die separat im Abschnitt Zubehör bestellt werden muss. Beim Steuerungssystem 1-10V werden alle Leuchten gleichzeitig geregelt (als Block oder Broadcast).

- Für die Steuerung mittels Casambi (max. 200 Leuchten) müssen Casambi-Leuchten bestellt werden, diese sind mit allen für das System verfügbaren Profilen kompatibel. Für Mobilgeräte ist die app FLOS Control® powered by Casambi erforderlich (erhältlich im Apple Store und auf Google Play).

Maximale Anzahl der Schienenverbindungen, um die Signalübermittlung von DALI oder 1-10V zu gewährleisten, beträgt 20 Verbindungen, einschließlich der Schnitte, oder 20 Meter.

Maximale Anzahl der Schienenschnitte, um die Signalübermittlung von DALI oder 1-10V zu gewährleisten, beträgt 3 Schnitte.

Die UP&DOWN-Version verfügt über eine kompatible DALI-Schnittstelle zur Steuerung der indirekten Beleuchtung. Da es sich um eine kompatible DALI-Komponente handelt, beachten Sie bitte, dass diese nicht auf erweiterte Funktionen des DALI-Protokolls reagieren kann. Weitere Informationen erhalten Sie im Abschnitt der technischen Spezifikationen auf der Website von Flos.

Die UP&DOWN-Version kann separat per DALI gesteuert werden.

Mit "Btcino My Home" kompatibel (Front Office um Beratung fragen).

Optisches System

- Light Stripe: diffuses indirektes Raumlucht.

- Spot 50: Medium.

- Spot 90: Medium.

- Spot 120 Power LED (Gleiche Lichtquelle der Spot 50 und Spot 90): Spot, Medium.

- Spot 120 LED Array (Gleiche Lichtquelle des Spot 150): Medium, Flood.

- Spot 150: Spot, Medium, Flood.

- Anthony Spot: Spot, Medium, Flood (mit Flood-Filter).

- Wallee: Wandbeleuchtung von Bildern.

Einspeisung

Fern-Netzteil 48V nicht enthalten.

Zubehör

Für das Beleuchtungsmodul Anthony Spot gibt es elyptische Linsen, Flood-Linsen (für die Verwendung mit Anthony Spot Medium) und Schirmelemente.

Für die Beleuchtungsmodule Spot Tracking schließt das Produkt die Zubehörteile Honeycomb und Schirmkreuz ein, bis auf das Chrom-Finish.

Die Aufhängeausführungen bieten zwei Aufhängensysteme an, die getrennt bestellt werden müssen: Starre Stangen zur Vermeidung einer Neigung des Profils (geradlinige Strukturen ohne Winkel oder für Installationen, bei denen ein starres Befestigungssystem erforderlich ist; auch wird ein Stahlkabel empfohlen, wenn ein Winkel in der Struktur enthalten ist, bei der auf keinen Fall eine Neigung eintritt).

Zusatzinformationen

Recessed Version ausschließlich zur Installation auf 12,5mm dicken Gipskarton Oberflächen.

The Tracking Magnet ist eine mit 48 V gespeiste elektrische Anlage, deren Maximalstrom zur Vorbeugung gegen Überlast auf 8A beschränkt ist.

Maximale Länge mit einem einzigen Netzteil: 20 m.

Schutzgrad IP20.

Auf normal entflammbar Oberflächen einsetzbar.

Qualitätszeichen

Das Gerät entspricht der europäischen technischen Norm EN60598-1 und den entsprechenden Zusatzregelungen.

Description

Renewed indoor lighting system for surface, suspended and recessed in plasterboard wall/ceiling installation.

In the new proposal, beside the successful "On Board Dimmer" version, FLOS goes one step beyond, launching both track and luminaires designed for system management in a variety of options: DALI, 1-10V and Casambi.

There are three profile versions (recessed, surface/suspension and Up&Down), all manufactured with aluminium profiling of a maximum of 3m extruded in white, black or polished aluminium, provided with electric tracks powered at 48V.

Furthermore, the system controlled versions (DALI, 1-10V) are equipped with graphite data bus for regulation.

Luminaires are installed through a magnetic fixing system.

The Tracking Magnet product group is complemented with ambient and accent lighting modules, with different optics. The light fixtures are available with potentiometer incorporated, dimmable DALI, 1-10V or Casambi for remote setting.

Control

- For installation of "On Board Dimmer" fixtures use "On Board Dimmer" track version. Luminaires DALI and 1-10V are only compatible with track DALI, 1-10V.

Casambi luminaires can be installed on all profiles available in the system.

- To manage using DALI protocol, it is necessary to connect the control data bus directly to the profile.

- For the 1-10V management, the control system needs to be active (SOURCE, the controller generates the power signal) and the control data bus needs to be directly connected to the profile. If the controller is passive (SINK), the Control Dimming box unit will be necessary. It is located between the control unit and the track, and it must be ordered separately from the accessories department. In the 1-10V management system, all luminaires are dimmed at the same time (as a block or broadcast).

- For Casambi management (Max. 200 luminaires) it is mandatory to use fixtures in the Casambi version, these are compatible with all profiles available in the system.

For managing and controlling the Casambi system, the FLOS Control® app powered by Casambi for mobile devices is necessary (available in the Apple Store and Google Play). Maximum number of track interconnections to guarantee the communication of the DALI or 1-10V signal: 20 interconnections including cuts, or 20 meters. Maximum number of track cuts to guarantee the communication of the DALI or 1-10V signal: 3 cuts.

The UP&DOWN version has a compatible DALI interface for controlling indirect lighting. Please note that since it is a DALI compatible component, it may not respond to advanced DALI protocol functions. For more information, see the technical specifications section on the Flos website.

The UP&DOWN version can be controlled independently via DALI.

Compatible with "Btcino My home" (please consult Front Office).

Optic system

- Light Stripe: diffuse ambient light.

- Spot 50: Medium.

- Spot 90: Medium.

- Spot 120 Power LED (same light source as the Spot 50 and Spot 90): Spot, Medium.

- Spot 120 LED Array (same light source as the Spot 150): Medium, Flood.

- Spot 150: Spot, Medium, Flood.

- Anthony Spot: Spot, Medium, Flood (with flood filter).

- Wallee: Wall frame lighting.

Power Supply

Remote 48V power supply not included.

Accessories

For the Anthony Spot lighting module there are elliptical, flood lenses (to be used with Anthony Spot Medium) and screening elements.

For the Spot tracking lighting modules, the honeycomb and screening crossbrace accessories are incorporated in the product, except for the chrome finish.

The Suspension versions offer two suspension systems that must be ordered separately: rigid bars to stop the profile tilting (straight structures with no corners) or for installations requiring a more rigid fixture system, and steel cable, recommended if a corner is included in the structure, where the tilt will not appear in any case.

Additional Information

Recessed version only to be installed in 12.5mm thick plasterboard surfaces.

The Tracking Magnet is a 48V electrical system limited to a maximum power current of 6.6A and 320W to avoid overloads.

Maximum length with a single power source is 20 m.

IP20 protection grade.

Suitable for installation on normally inflammable surfaces.

Compliance of Standards and Quality Marks

EN60598-1 European Technical Standards and any subsequent additions.

HOW TO ORDER

1 CHOOSE YOUR PROFILE AND LENGTH

2 COMPLETE WITH MOUNTING ACCESSORIES

RECESSED PROFILE

L: 1 / 1,5 / 2 / 2,5 / 3 m

Feed connector 	End cap
Intermediate connector 	90° Corner
Straight Flexible/Electrical corner 	mechanical joint
Inner corner 	Outer corner
mechanical joint 	mechanical joint

Recessed installation

Accessories

Fixed ceiling kit 	Adjustable ceiling kit
-----------------------	----------------------------

or

SURFACE/SUSPENSION DOWN PROFILE

L: 1 / 1,5 / 2 / 2,5 / 3 m

Feed connector 	End cap
Intermediate connector 	90° Corner
Straight Flexible/Electrical corner 	mechanical joint
Inner corner 	
mechanical joint 	

Surface installation

Accessories

Fixed ceiling kit

Suspension Down installation

Accessories

Suspension kit 		
Surface rose or Recessed rose 	Power cable 	Rigid rod or Suspension cable

SUSPENSION UP&DOWN PROFILE

L: 1 / 1,5 / 2 / 2,5 / 3 m

Power connector profile 	End cap
Intermediate connector 	90° Corner
Straight Flexible/Electrical corner 	mechanical joint
Intermediate suspension kit 	

Suspension Up&Down installation

Accessories

Surface rose or Recessed rose 	Power cable 	Rigid rod or Suspension cable
---	-----------------	---

THE TRACKING MAGNET

3 SELECT POWER SUPPLY AND CONTROL OPTION

Recessed installation
Remote power supply



185W or 320W

(select the driver with the appropriate power according to the needs of your project)

On board dimmer / Casambi / Dali



185W or 320W

(select the driver with the appropriate power according to the needs of your project)

+



1-10V control box

(needed only to transform sink into source control signal)

1-10V

Surface installation
Remote power supply



185W or 320W

(select the driver with the appropriate power according to the needs of your project)

On board dimmer / Casambi / Dali



185W or 320W

(select the driver with the appropriate power according to the needs of your project)

+



1-10V control box

(needed only to transform sink into source control signal)

1-10V

Suspension Down installation
Remote power supply



185W or 320W

(select the driver with the appropriate power according to the needs of your project)

On board dimmer / Casambi / Dali



185W or 320W

(select the driver with the appropriate power according to the needs of your project)

+



1-10V control box

(needed only to transform sink into source control signal)

1-10V

Surface power supply



(only for 1-10V source signal)

On board dimmer / Casambi / Dali / 1-10V

Suspension Up&Down installation

Remote power supply

Surface power supply

Down instal.

Up instal.

Down instal.

Up instal.

On board dimmer



185W or 320W

Casambi



185W or 320W

Dali

+



DALI Push

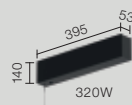

140

395

53

320W

1-10V



185W or 320W



1-10V control box

(needed only to transform sink into source control signal)

+



1-10V Push

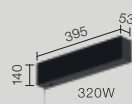

(only for 1-10V source signal)

4 SELECT A LIGHT MODULE AND CONTROL OPTION

Dali / 1-10V / Casambi / On board dimmer

Light Stripe



General lighting

Spot 50



M

Spot 90



S/M

Spot 120



S/M/F

Spot 150



S/M/F

Anthony Spot Track



S/M

Wallee



General lighting

Multifunction Smart Device

FLOS Control® by Casambi



THE TRACKING MAGNET RECESSED – PROFILES

Profile

Elektromechanische Profile für den Einbau in Gipskartondecken und -wänden mit einer Länge von 1m bis 3m.
 Kompatible Version mit „On Board Dimmer“-Leuchten und Casambi verfügbar. Kompatible Version mit steuerbaren Leuchten wie DALI und 1-10V. Gemeinsame Ecken-, Verbinderelemente und Zubehör für beide Schienenversionen.
 Netzanschluss, Zwischenstecker und Abdeckungen sind separat zu bestellen. Mechanische 90°-Ecken verfügbar auf derselben Ebene (symmetrisches Element für die linke und rechte Ecke), symmetrische 90°-Innen- und Außenecken auf verschiedenen Ebenen.
 Zwischenstecker sind separat zu bestellen, um die elektrische Kontinuität in den Ecken zu gewährleisten. In den Ecken können keine Spots angebracht werden.
 Befestigungsbausätze für fixierte oder verstellbare Modelle sind erhältlich (optional). Die Bausätze für die Deckenbefestigung ermöglichen die Installation ohne Aluminium-Befestigungsprofile. Empfohlen für Installationen, bei denen das Profil Tracking Magnet vor dem Einbau der Gipskartonplatte verlegt kann.

Profiles

Electromechanical profile for recessed installation in plasterboard ceilings and walls, available in lengths from 1m to 3m.
 A version compatible with 'On Board Dimmer' and Casambi light fixtures is available. Version compatible with controllable lights such as DALI and 1-10V systems. Corners, connectors and accessories common for the two profile versions.
 Feed connector, intermediated connector and end-caps to be ordered separately.
 Mechanical 90° corners available in the same plane (symmetrical element for left and right corners), symmetrical 90° inner and outer corners in different planes.
 Intermediate connectors to be ordered separately if electrical continuity on corners is required.
 Corners do not admit installation of spots.
 Fixed or adjustable fastening kits available (optional). The fastening kits for the roof permit installing without using aluminium fastening profiles.
 Recommended for installations where the Tracking Magnet can be installed before the suspended plasterboard ceiling.

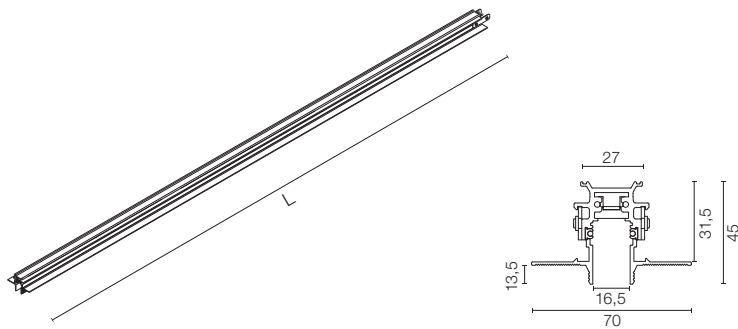

L: 1 m / 1,5 m / 2 m / 2,5 m / 3 m

Casambi / On board dimmer compatible

- L: 1000 mm ■ 06.5050.14
- L: 1500 mm ■ 06.5051.14
- L: 2000 mm ■ 06.5052.14
- L: 2500 mm ■ 06.5053.14
- L: 3000 mm ■ 06.5054.14

Casambi / DALI / 1-10V compatible

- L: 1000 mm ■ 06.5040.14
- L: 1500 mm ■ 06.5041.14
- L: 2000 mm ■ 06.5042.14
- L: 2500 mm ■ 06.5043.14
- L: 3000 mm ■ 06.5044.14

Mechanischer Winkel 90°. Für die Herstellung elektrischer Kontinuität, zusammen mit dem biegsamen Zwischenschalter bestellen.

90° mechanical corner. To create electrical continuity, order with the flexible intermediate connector.

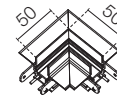

■ 06.5045.14

Mechanischer Innenwinkel. Für die Herstellung elektrischer Kontinuität, zusammen mit dem biegsamen Zwischenschalter bestellen.

Inner mechanical corner. To create electrical continuity, order with the flexible intermediate connector.

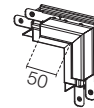

■ 06.5046.14

Mechanischer Außenwinkel. Für die Herstellung elektrischer Kontinuität, zusammen mit dem biegsamen Zwischenschalter bestellen.

Outer mechanical corner. To create electrical continuity, order with the flexible intermediate connector.

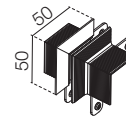

■ 06.5047.14

Versorgungsanschluss.

Feed connector.

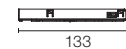

■ 08.0611.14

Mittlerer Verbinder.

Intermediate connector.

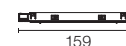

Straight ■ 08.0612.14

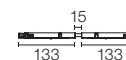

Flexible/Electrical corner ■ 08.0614.14

THE TRACKING MAGNET RECESSED – PROFILES

Befestigungssatz feste decke (fakultativ). Set mit 2 stück.

Fixed ceiling kit (optional). 2 unit kit.

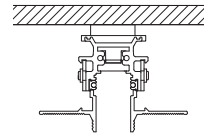

■ 08.8866.14

Befestigungssatz an absenkbare decke (fakultativ). Set mit 2 stück.

Adjustable ceiling kit (optional). 2 unit kit.

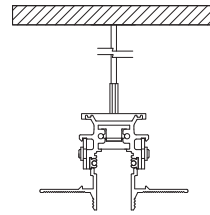

■ 08.8867.14

Profile (mm)	Quantities Ceiling Kit
1000 / 1500	1
2000 / 2500	2
3000	2

Endkappe. Muss separat bestellt werden. Set mit 2 stück.

End caps. To be ordered separately. 2 unit kit.



■ 06.5008.14

THE TRACKING MAGNET SURFACE/SUSPENSION – PROFILES

Profile

Elektromechanische Profile für Aufputzmontage oder zum Aufhängen mit einer Länge von 1m bis 3m.
 Kompatible Version mit „On Board Dimmer“-Leuchten und Casambi verfügbar. Kompatible Version mit steuerbaren Leuchten wie DALI und 1-10V. Gemeinsame Ecken-, Verbinderelemente und Zubehör für beide Schienenversionen.
 Netzanschluss, Zwischenstecker und Abdeckungen sind separat zu bestellen. Mechanische 90°-Ecken verfügbar auf derselben Ebene (symmetrisches Element für die linke und rechte Ecke), symmetrische 90°-Innen- und Außenecken auf verschiedenen Ebenen.
 Zwischenstecker sind separat zu bestellen, um die elektrische Kontinuität in den Ecken zu gewährleisten.
 In den Ecken können keine Spots angebracht werden.

Profiles

Electromechanical profile for surface-mounting, available in lengths from 1m to 3m.
 A version compatible with 'On Board Dimmer' and Casambi light fixtures is available. Version compatible with controllable lights such as DALI and 1-10V systems. Corners, connectors and accessories common for the two profile versions.
 Feed connector, intermediated connector, end-caps and attachment accessories to be ordered separately.
 Mechanical 90° corners available in the same plane (symmetrical element for left and right corner) and 90° symmetrical internal corners in a different plane.
 Intermediate connectors to be ordered separately if electrical continuity on corners is required.
 Corners do not admit installation of spots.

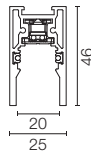
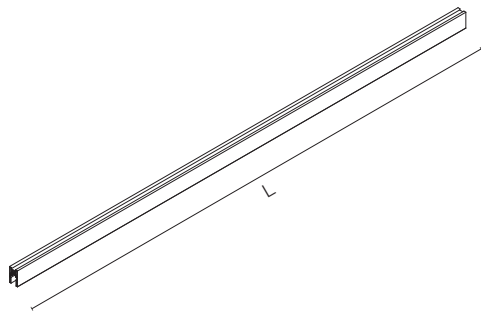

L: 1 m / 1,5 m / 2 m / 2,5 m / 3 m

Casambi / On board dimmer compatible

- L: 1000 mm
- 06.5060.40
- 06.5060.05
- 06.5060.14
- L: 1500 mm
- 06.5061.40
- 06.5061.05
- 06.5061.14
- L: 2000 mm
- 06.5062.40
- 06.5062.05
- 06.5062.14
- L: 2500 mm
- 06.5063.40
- 06.5063.05
- 06.5063.14
- L: 3000 mm
- 06.5064.40
- 06.5064.14

Casambi / DALI / 1-10V compatible

- L: 1000 mm
- 06.5010.40
- 06.5010.05
- 06.5010.14
- L: 1500 mm
- 06.5011.40
- 06.5011.05
- 06.5011.14
- L: 2000 mm
- 06.5012.40
- 06.5012.05
- 06.5012.14
- L: 2500 mm
- 06.5013.40
- 06.5013.05
- 06.5013.14
- L: 3000 mm
- 06.5014.40
- 06.5014.14

Mechanischer Winkel 90°. Für die Herstellung elektrischer Kontinuität, zusammen mit dem biegsamen Zwischenschalter bestellen.

90° mechanical corner. To create electrical continuity, order with the flexible intermediate connector.

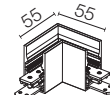

- 06.5015.40
- 06.5015.05
- 06.5015.14

Innenwinkel. Nur für die Surface-Ausführung.

Inner mechanical corner. Only for surface version.

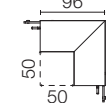

- 06.5016.40
- 06.5016.05
- 06.5016.14

Versorgungsanschluss.

Feed connector.

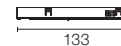

- 08.0611.14

Mittlerer Verbinder.

Intermediate connector.



- Straight
- 08.0612.14

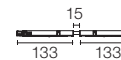

- Flexible/Electrical corner
- 08.0614.14

Endkappe. Muss separat bestellt werden. Set mit 2 Stück.

End caps. To be ordered separately. 2 unit kit.



- 06.5017.40
- 06.5017.05
- 06.5017.14

THE TRACKING MAGNET SURFACE/SUSPENSION

Zubehör / Accessories

Suspension

Einspeisungsrosette zur Oberflächenmontage. Ausrüstung, Netzkabel und Aufhängekabel nicht enthalten, bitte separat bestellen. Gilt nicht für Installationen mit Aufhängungsstangen.

Surface rose. Equipment, power cable and suspension cable not included. They must be ordered separately. Not suitable for installations with suspension rods.

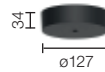

08.8883.40A
08.8883.14A

Einspeisungsrosette für den versenkten Einbau. Ausrüstung, Netzkabel und Aufhängekabel nicht enthalten, bitte separat bestellen. Gilt nicht für Installationen mit Aufhängungsstangen.

Recessed power supply rose. Equipment, power cable and suspension cable not included. They must be ordered separately. Not suitable for installations with suspension rods.



08.8889.40
08.8889.14

4-poliges, transparentes Stromkabel mit 0,75 mm² Querschnitt und 4 m Länge.

4-pole, 0.75 mm² section, 4-meter long, transparent power cable.



06.0157.00

Feste Stangen, um das Verformen der Profile (bei geraden Strukturen ohne Winkel) zu verhindern bzw. für Installationen, bei denen ein stabileres Befestigungssystem erforderlich ist.

Rigid rod to avoid the profile from tilting (rectilinear structures without corners) or to be installed in places where a more rigid fixing system is required.

Abhängestab mit Baldachin 1 m. Gewinde m6. Nicht anwendbar für Oberflächengehäuse.

1 m suspension rod with ceiling rose. M6 thread. Not applicable with a Surface power box.



60.3014.11
60.3014.14

Verlängerung Abhängestab 1 m. Gewinde M6.

1 m suspension rod extension set m6 thread.



60.3097.11
60.3097.14

4 m Stahlseil, empfohlen, wenn die Struktur eine oder mehrere Ecken aufweist, da bei diesen Strukturen die Schiene nicht kippt, obwohl das Gewicht der Leuchten nicht ausgeglichen ist.

A 4-meter steel suspension cable is recommended if the structure includes one or more angles, since in these structures the track does not tilt even if the weight of the luminaries is not balanced.



08.8634.00

Menge der erforderlichen Befestigungselemente (Kabel oder Stangen):
Wenn gradlinige Profile verbunden werden, ergibt sich die erforderliche Menge aus der Summe der pro Profil erforderlichen Elemente laut Tabelle, abzüglich eines Elements pro Einheit.

Amount of fastening elements necessary (cables or rods) for the union of rectilinear profiles, the necessary amounts shall be the sum of the necessary elements for each profile, according to the table, one less for each joint.

Profile (mm)	Quantities Ceiling Kit
1000 / 1500	2
2000 / 2500	3
3000	4

Suspension

Stromversorgungsbox mit Ausstattung inklusive 320W / 48VDC. Inklusive 4-poligem und 4m transparentem Kabel. Gilt nicht für Installationen mit Aufhängungsstangen. Verwenden Sie zur Steuerung von 1-10 V nur aktive Signale.

Surface power supply with 320W / 48Vdc driver included. 4-meter, 4-pole transparent cable included. Not suitable for installations with suspension rods. For 1-10V control, use only active signals.

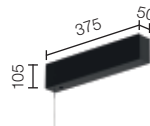

08.0600.40
08.0600.14

Deckenbefestigungskit. Set mit 2 stück.

Ceiling fixing kit. 2 unit kit.

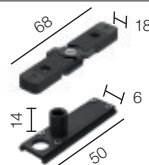

Surface
08.0615.00

Suspension
08.0616.00

THE TRACKING MAGNET SUSPENSION UP&DOWN – PROFILES

Profile

Elektromechanisches Profil für Deckenstrukturen.
Die linearen Elemente in der Up&Down-Version enthalten eine indirekte LED-Beleuchtung im oberen Bereich des Profils.
Kompatible Version mit „On Board Dimmer“-Leuchten und Casambi verfügbar. Kompatible Version mit steuerbaren Leuchten wie DALI und 1-10V. Aufhängezubehör (Stahlkabel und Stangen) müssen separat bestellt werden. 90°-Ecken verfügbar auf derselben Ebene (symmetrisches Element für die linke und rechte Ecke).
Die Eckteile haben keine indirekte Beleuchtung. Indirekte Beleuchtung kann entweder durch den selben Schaltkreis der direkten Beleuchtung gesteuert werden oder unabhängig davon.
Die Up&Down-Version kann unabhängig über DALI.

Profiles

Electrical/mechanical profile for suspended installations.
The linear elements in the Up&Down version include indirect LED lighting in the upper part of the profile.
A version compatible with 'On Board Dimmer' and Casambi light fixtures is available. Version compatible with controllable lights such as DALI and 1-10V systems.
The profiles cannot be cut. The end caps must be ordered separately.
Suspension accessories (steel cable and rods) should be ordered separately. 90° corners available in the same plan (symmetrical element for left and right corners).
The corners do not have indirect lighting. Indirect lighting can be controlled either through the same circuit than direct lighting or independently.
The Up&Down version can be controlled independently via DALI.

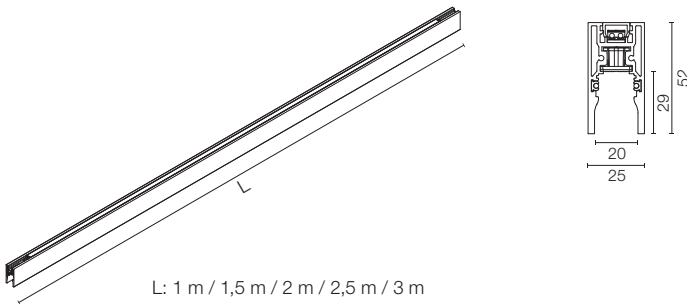

Light Source: Top LED 6,5W/m Up - 630 lm/m Up - 3000K/CRI 80

Casambi / On board dimmer compatible
L: 1000 mm
06.5070.40
06.5070.05
06.5070.14

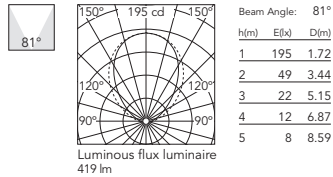

Casambi / DALI / 1-10V compatible
L: 1000 mm
06.5020.40
06.5020.05
06.5020.14

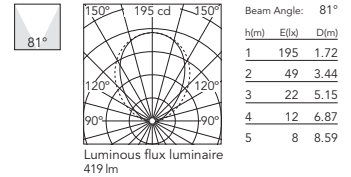

L: 1500 mm
06.5071.40
06.5071.05
06.5071.14

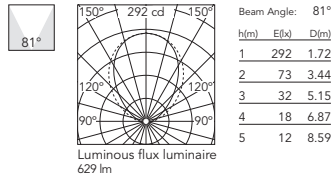

L: 1500 mm
06.5021.40
06.5021.05
06.5021.14

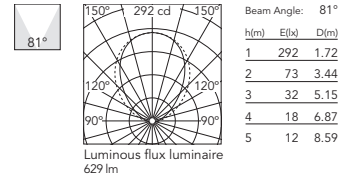

L: 2000 mm
06.5072.40
06.5072.05
06.5072.14

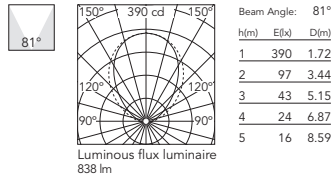

L: 2000 mm
06.5022.40
06.5022.05
06.5022.14

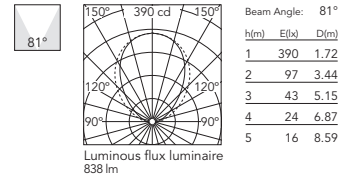

L: 2500 mm
06.5073.40
06.5073.05
06.5073.14

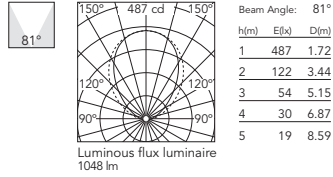

L: 2500 mm
06.5023.40
06.5023.05
06.5023.14

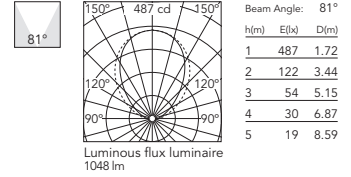

L: 3000 mm
06.5074.40
06.5074.14

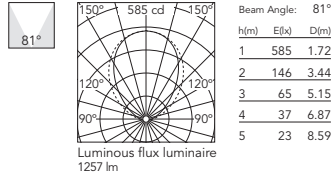

L: 3000 mm
06.5024.40
06.5024.14

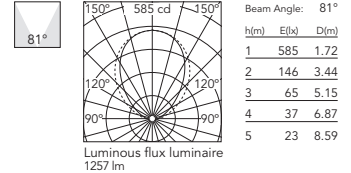

THE TRACKING MAGNET SUSPENSION UP&DOWN – PROFILES

Zubehör / Accessories

90 ° mechanische Ecke.
Zwei endgültige
Aufhängungsanschlüsse enthalten.
Stahlkabel nicht im Lieferumfang
enthalten. Keine Beleuchtung oben. Top
Anschlüsse inklusive.

90° mechanical angle.
Two end suspension connections
included. Steel cable not included. No
lighting on the upper part. Upper part
connections included.

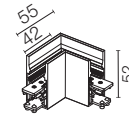

06.5025.40
06.5025.05
06.5025.14

Zwischenfederungssatz zum Verbinden
von Profilen. Es beinhaltet den
elektrischen Anschluss des oberen
Teils. Notwendiger Zwischenstecker,
separat bestellen. Stahlkabel nicht im
Lieferumfang enthalten.

Intermediate suspension kit for joining
profiles. It includes the electrical
connection of the upper part. An
intermediate connector is necessary.
It must be ordered separately. Steel
cable not included.



08.0627.00

Stromanschluss. Beinhaltet zwei
Aufhängezubehöerteile für die Enden des
Profils sowie ein 6-poliges und ein 4 m
langes elektrisches Kabel. Stahlkabel
nicht im Lieferumfang enthalten. Das
zentrale Aufhängezubehör ist im Profil
enthalten.

Power connector. Includes two
suspension accessories for the profile
ends and a 6-pole and 4-meter
long electrical cable. Steel cable
not included. Central suspension
accessories are included in the profile.

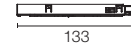

08.0626.00

Mittlerer Verbinder.

Intermediate connector.

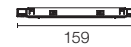

Straight
08.0612.14

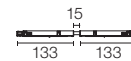

Flexible/Electrical corner
08.0614.14

Endkappe. Muss separat bestellt werden.
Set mit 2 Stück.

End caps. To be ordered separately.
2 unit kit.



06.5026.40
06.5026.05
06.5026.14

Einspeisungsrosette zur
Oberflächenmontage. Ausrüstung,
Netzkabel und Aufhängekabel nicht
enthalten, bitte separat bestellen.

Surface rose. Equipment, power cable
and suspension cable not included.
They must be ordered separately.



08.8883.40A
08.8883.14A

Einspeisungsrosette für den versenkten
Einbau. Ausrüstung, Netzkabel und
Aufhängekabel nicht enthalten, bitte
separat bestellen.

Recessed power supply rose.
Equipment, power cable and
suspension cable not included. They
must be ordered separately.

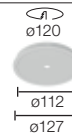

08.8889.40
08.8889.14

Feste Stangen, um das Verformen der Profile (bei geraden Strukturen ohne Winkel) zu verhindern bzw. für Installationen, bei denen ein stabileres Befestigungssystem erforderlich ist. / Rigid rod to avoid the profile from tilting (rectilinear structures without corners) or to be installed in places where a more rigid fixing system is required.

Abhängestab mit Baldachin 1 m.
Gewinde m6. Nicht anwendbar für
Oberflächengehäuse.

Suspension rod with 1 m rose. m6
thread. Not applicable with a surface
power box.



60.3014.11
60.3014.14

Verlängerung Abhängestab 1 m.
Gewinde M6.

1 m suspension rod extension set m6
thread.



60.3097.11
60.3097.14

Anzahl der erforderlichen
Befestigungselemente (Kabel und
Verbindungsstücke): beim Verbinden
von linearen Profilen entspricht die
für Einbauinstallationen erforderliche
Menge der Summe der für jedes Profil
erforderlichen Elemente abzüglich eines
Elements für jede Verbindung.
Bei Oberflächeninstallationen entspricht
die Menge der Summe der Elemente.

Number of fastening elements
necessary (cables and connections):
when linear profiles are joined, the
number necessary for recessed
installation is equal to the sum of the
elements necessary for each profile
minus one for each junction.
For surface installation, the number is
equal to the sum of the elements.



08.8634.00

Profile (mm)	Quantities Ceiling Kit
1000 / 1500	2
2000 / 2500	3
3000	4

Versorgungsgerät mit Ausrüstung
inklusive 320W / 48Vdc. Stahl- und
Elektrokabel nicht enthalten. Gilt nicht
für die Montage mit Aufhängestangen.
DALI / 1-10V / 0-10V / No dim.

Surface power supply with driver
included 320W / 48Vdc. Steel and
electric cables not included. Not valid
for installation with suspension rods.
DALI / 1-10V / 0-10V / No dim.

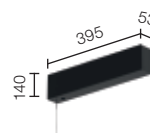

1-10V
08.0631.40
08.0631.14
Dali Version
08.0632.40
08.0632.14

THE TRACKING MAGNET – INSTALLATION PROFILES

RECESSED INSTALLATION

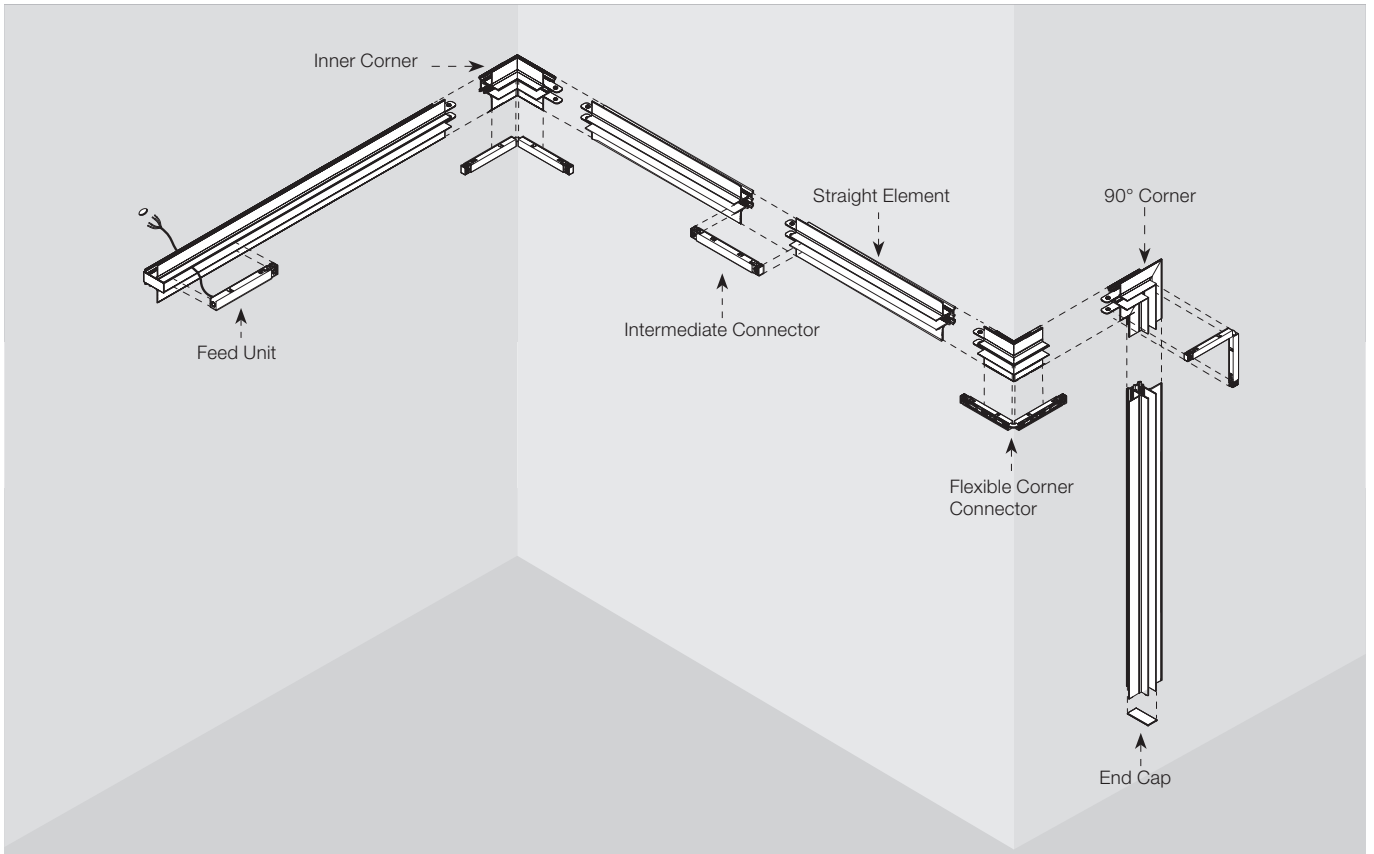

SURFACE INSTALLATION

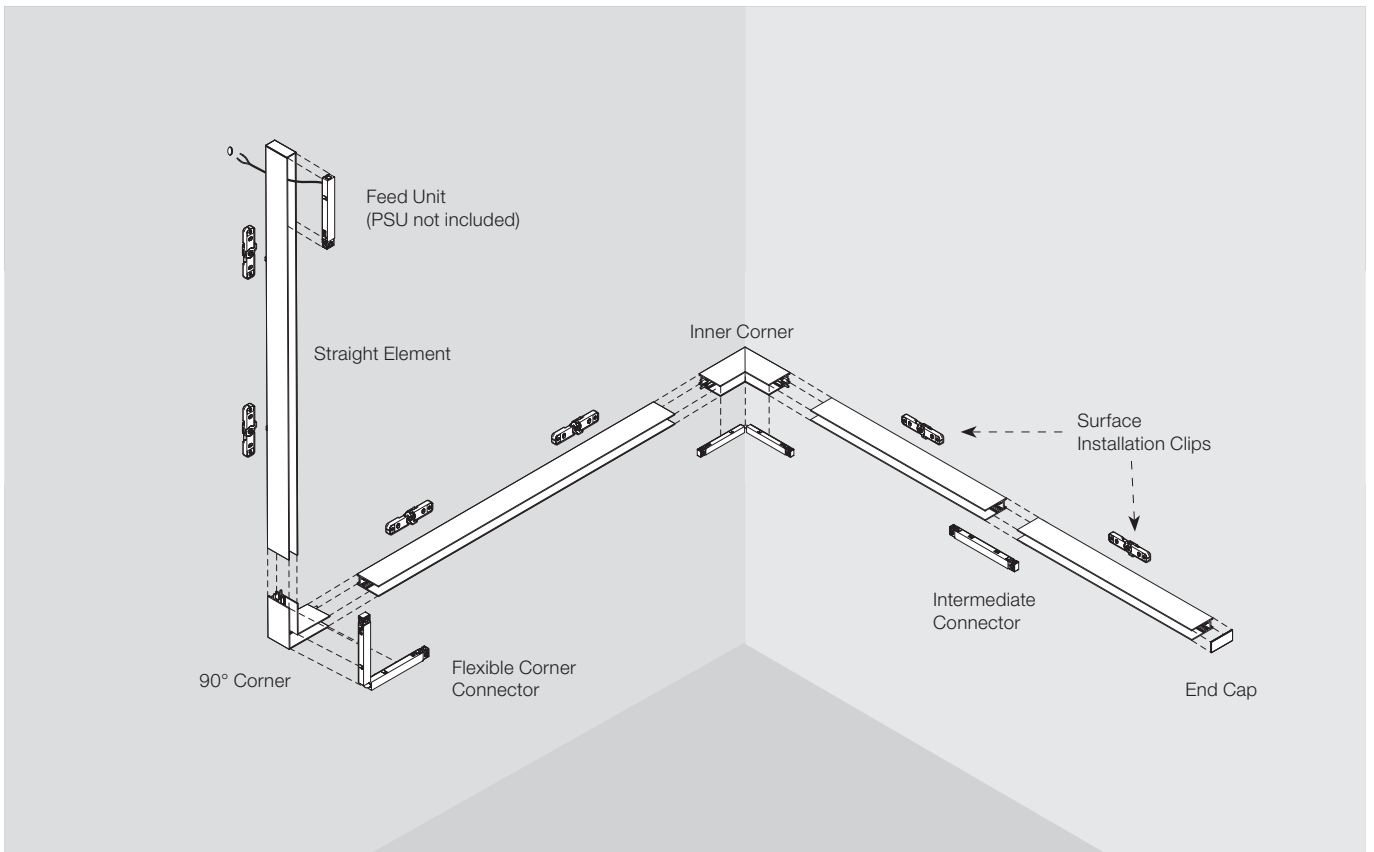

THE TRACKING MAGNET – INSTALLATION PROFILES

SUSPENSION INSTALLATION

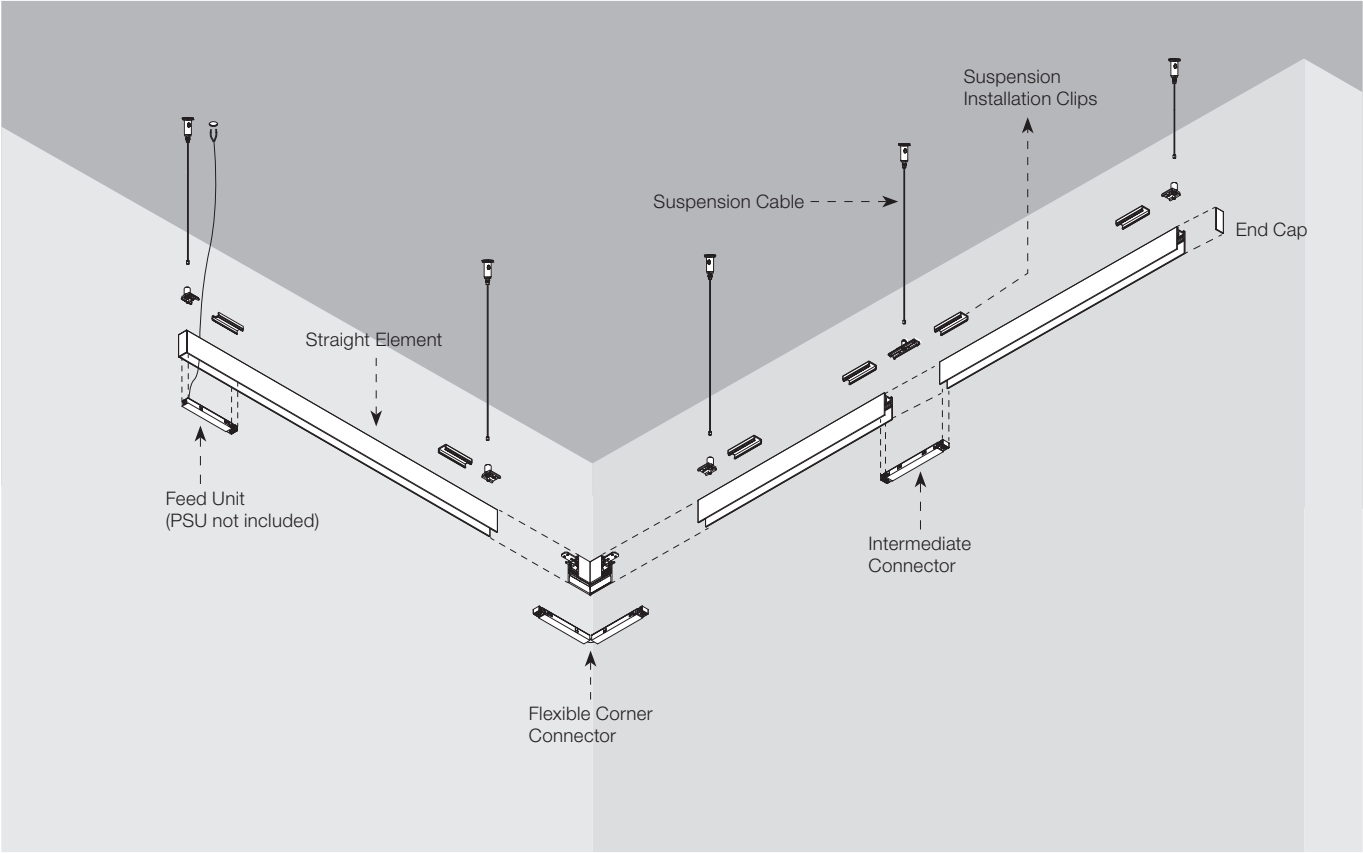

THE TRACKING MAGNET – FAQ

• Kann ich eine Konstruktion direkt aus der Ecke mit Strom versorgen?

Ja, für die linearen Profile neben der Ecke müssen ein oder zwei Stromanschlüsse verwendet werden, je nachdem, ob Sie nur eines der mit der Ecke verbundenen Profile oder beide versorgen möchten.

• Können die Profile zugeschnitten werden?

Ja, die Profile können auf die gewünschte Größe zugeschnitten werden, außer in den Versionen Up & Down. Berücksichtigen Sie immer beim Schneiden, den vorhergesehenen Durchgang für das Stromkabel. Die elektrische Kontinuität wird mit dem Zwischenstecker hergestellt. Wenn Sie nach dem Schnitt eine neue Stromversorgung benötigen, müssen Sie die Stelle für die Kabeldurchführung bohren, und zwar in dem Bereich ohne Graphit, der hierfür vorgesehen wurde, und einen Netzstecker verwenden. Es dürfen unter keinen Umständen die Stellen mit Graphit durchbohrt werden.

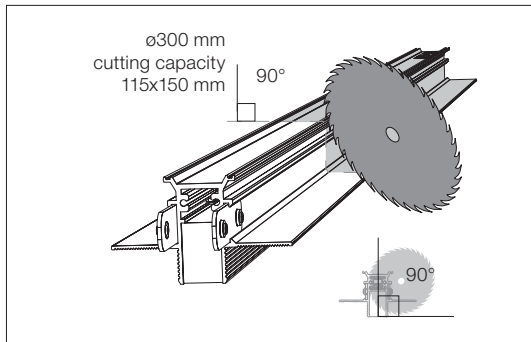

• Wie hoch ist die maximal zulässige Entfernung zwischen Netzteil und Profil?

Bei den empfohlenen Stromquellen beträgt die maximal zulässige Entfernung:
 . Kabel Ø 1,5 mm: 3 m
 . Kabel Ø 2,5 mm: 5 m

• Wie lang darf eine Struktur höchstens sein, damit ein Netzteil sie versorgen kann?

Die maximale Länge eines Profils, das mit einer Stromversorgung gespeist werden kann, beträgt 20 Meter oder der resultierende Abstand nach 7 Verbindungen, einschließlich der Schnitte.

• Ist es möglich, ein weniger leistungsstarkes Netzteil zu verwenden?

Sämtliche auf unserer Website, unserem Katalog und in unseren Installationsanweisungen veröffentlichten Informationen entsprechen den Tests, die mit den für unsere Produkte empfohlenen Stromquellen durchgeführt wurden. Es muss sich um eine 48V-Stromversorgung mit einer maximalen Leistung von 320 W handeln.

• Can I feed a structure directly from a corner?

Yes. One or two power connectors must be used for linear profiles along with the corner, depending on whether you want to power just one of the profiles connected to the corner or both profiles.

• Can I cut a profile?

Yes, profiles can be cut to the desired size, except for the Up & Down versions. Always cut respecting the space reserved for inserting the power cable. The electrical continuity is done with the intermediate connector. If you need a new power cable after cutting, you must drill the power cable's pass-through hole in the area free of graphite tracks reserved for that purpose and use a feed connector, you should never drill through the graphite tracks.

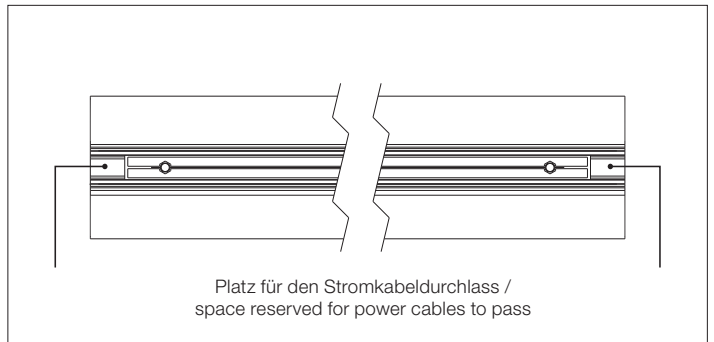

• What is the maximum distance allowed between the driver and the profile?

With the recommended power sources, the maximum distance permitted is:
 . Ø1.5 mm cable: 3 m
 . Ø2.5 mm cable: 5 m

• What is the maximum length that can be fed with one power supply?

The maximum length of a profile that can be fed with a power supply is 20 meters or the resulting distance after 7 interconnections including cuts.

• Can I use a different, less powerful power supply?

All the information published on our website, catalogue and installation instructions meet the tests executed with the power sources recommended for our products. It must be a 48V power source with a maximum power of 320W.

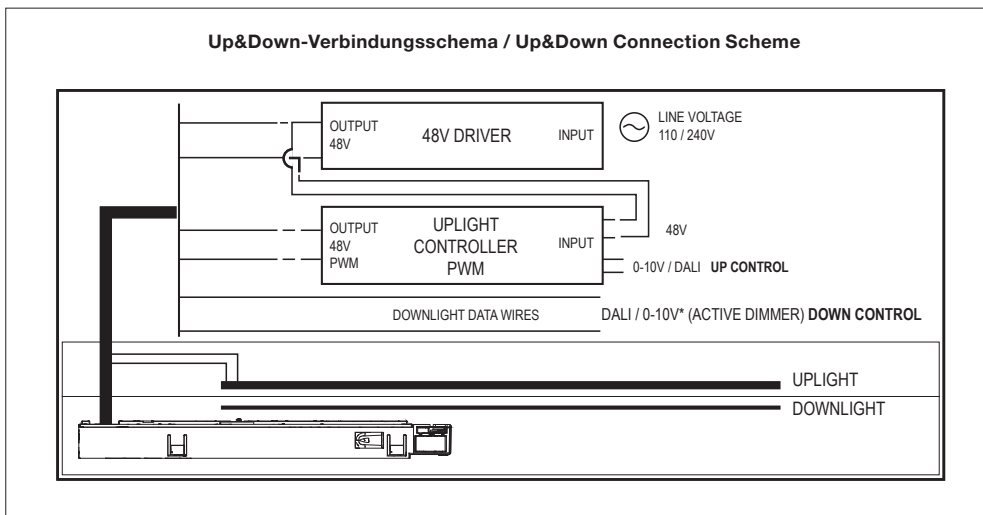

THE TRACKING MAGNET – LIGHT MODULES

Light Stripe

Light Source: Top LED 20W/m - 1859 lm/m - 2700K/CRI 90 / 20W/m - 1967 lm/m - 3000K/CRI 90

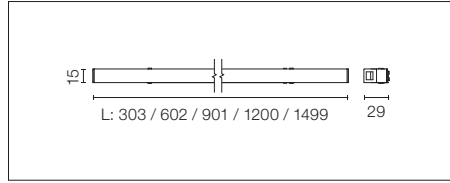

LED-Modul für diffuses Licht zur Installation in das System The Tracking Magnet. Opale Endkappen nicht im Lieferumfang enthalten, separat bestellen (08.0125.00 - Enthält zwei Einheiten). Für die kabellose Steuerung der Leuchten sind die integrierten Casambi-Versionen auszuwählen.

Diffused LED light module to be installed in The Tracking Magnet System. Opal end covers not included. They must be ordered separately (08.0125.00 - two units included). For wireless lighting control, choose integrated Casambi versions.

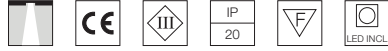

- 2700K**
L: 300 mm - 6W - 558lm
On board dimmer
■ 03.8000.14
*Dali2 Version
■ 03.8000.14ADA
*1-10V
■ 03.8000.14.1V
**Casambi integrated
■ 03.8000.14.CB

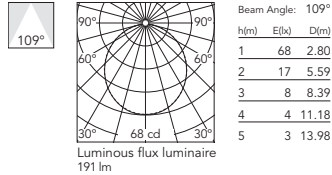

- 3000K**
L: 300 mm - 6W - 590lm
On board dimmer
■ 03.8005.14
*Dali2 Version
■ 03.8005.14ADA
*1-10V
■ 03.8005.14.1V
**Casambi integrated
■ 03.8005.14.CB

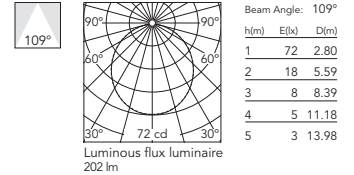

- 2700K**
L: 600 mm - 12W - 1115lm
On board dimmer
■ 03.8001.14
*Dali2 Version
■ 03.8001.14ADA
*1-10V
■ 03.8001.14.1V
**Casambi integrated
■ 03.8001.14.CB

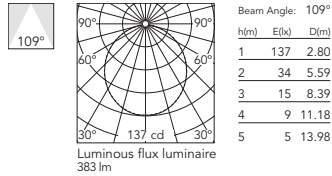

- 3000K**
L: 600 mm - 12W - 1180lm
On board dimmer
■ 03.8006.14
*Dali2 Version
■ 03.8006.14ADA
*1-10V
■ 03.8006.14.1V
**Casambi integrated
■ 03.8006.14.CB

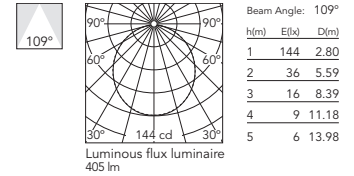

- 2700K**
L: 900 mm - 18W - 1673lm
On board dimmer
■ 03.8002.14
*Dali2 Version
■ 03.8002.14ADA
*1-10V
■ 03.8002.14.1V
**Casambi integrated
■ 03.8002.14.CB

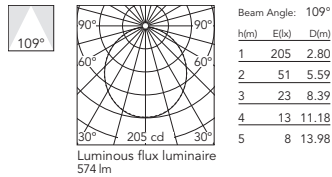

- 3000K**
L: 900 mm - 18W - 1770lm
On board dimmer
■ 03.8007.14
*Dali2 Version
■ 03.8007.14ADA
*1-10V
■ 03.8007.14.1V
**Casambi integrated
■ 03.8007.14.CB

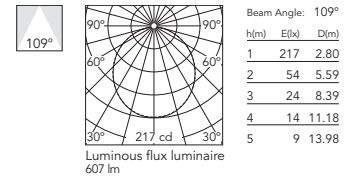

- 2700K**
L: 1200 mm - 24W - 2230lm
On board dimmer
■ 03.8003.14
*Dali2 Version
■ 03.8003.14ADA
*1-10V
■ 03.8003.14.1V
**Casambi integrated
■ 03.8003.14.CB

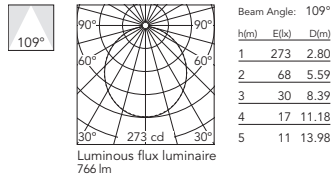

- 3000K**
L: 1200 mm - 24W - 2360lm
On board dimmer
■ 03.8008.14
*Dali2 Version
■ 03.8008.14ADA
*1-10V
■ 03.8008.14.1V
**Casambi integrated
■ 03.8008.14.CB

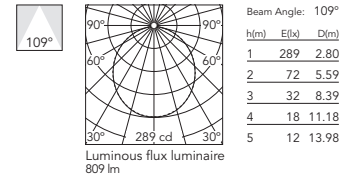

- 2700K**
L: 1500 mm - 30W - 2788lm
On board dimmer
■ 03.8004.14
*Dali2 Version
■ 03.8004.14ADA
*1-10V
■ 03.8004.14.1V
**Casambi integrated
■ 03.8004.14.CB

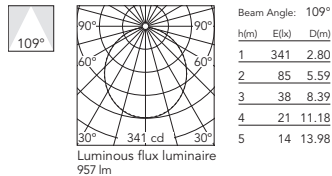

- 3000K**
L: 1500 mm - 30W - 2950lm
On board dimmer
■ 03.8009.14
*Dali2 Version
■ 03.8009.14ADA
*1-10V
■ 03.8009.14.1V
**Casambi integrated
■ 03.8009.14.CB

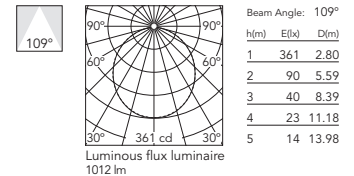

* Nur mit der Profiversion DALI, 1-10V kompatibel / Only compatible with DALI, 1-10V profile version .

** Die Steuerung bei den Casambi-Leuchten erfolgt direkt und individuell kabellos mittels der App FLOS Control® powered by Casambi / The control system with the Casambi version of light fixtures is directly and individually regulated wirelessly using the application FLOS Control® by Casambi.

THE TRACKING MAGNET – LIGHT MODULES

Spot 50

Light Source: Power LED 3,5W - 286 lm - 2700K/CRI 90 / 3,5W - 307 lm - 3000K/CRI 90

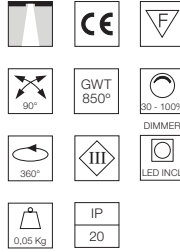
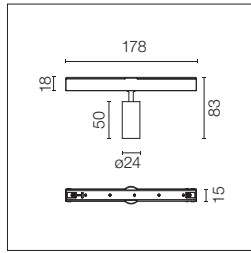

LED-Modul für Akzentbeleuchtung zur Installation in das System The Tracking Magnet.
Für die kabellose Steuerung der Leuchten sind die integrierten Casambi-Versionen auszuwählen.

Accent lighting LED module to be installed in The Tracking Magnet System.
For wireless lighting control, choose integrated Casambi versions.

Inkludiertes Zubehör (Honeycomb und Blendschutzgitter) außer dem Chrom-Finish.

Accessories included (honeycomb and screening crosspiece) except for the chrome finish.

2700K

On board dimmer

- 03.8032.40A
- 03.8032.05A
- 03.8032.14A
- *Dali2 Version
- 03.8032.40ADA
- 03.8032.05ADA
- 03.8032.14ADA
- *1-10V
- 03.8032.40A1V
- 03.8032.05A1V
- 03.8032.14A1V
- **Casambi integrated
- 03.8032.40ACB
- 03.8032.05ACB
- 03.8032.14ACB

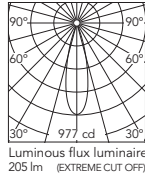

Beam Angle: 26°

h(m)	E(lx)	D(m)
1	977	0.47
2	244	0.94
3	109	1.41
4	61	1.88
5	39	2.35

3000K

On board dimmer

- 03.8033.40A
- 03.8033.05A
- 03.8033.14A
- *Dali2 Version
- 03.8033.40ADA
- 03.8033.05ADA
- 03.8033.14ADA
- *1-10V
- 03.8033.40A1V
- 03.8033.05A1V
- 03.8033.14A1V
- **Casambi integrated
- 03.8033.40ACB
- 03.8033.05ACB
- 03.8033.14ACB

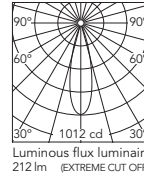

Beam Angle: 26°

h(m)	E(lx)	D(m)
1	1012	0.47
2	253	0.94
3	112	1.41
4	63	1.88
5	40	2.35

* Nur mit der Profilverision DALI, 1-10V kompatibel / Only compatible with DALI, 1-10V profile version .

** Die Steuerung bei den Casambi-Leuchten erfolgt direkt und individuell kabellos mittels der App FLOS Control® powered by Casambi / The control system with the Casambi version of light fixtures is directly and individually regulated wirelessly using the application FLOS Control® by Casambi.

THE TRACKING MAGNET – LIGHT MODULES

Spot 90

Light Source: Power LED 8,5W - 610 lm - 2700K/CRI 90 / 8,5W - 656 lm - 3000K/CRI 90

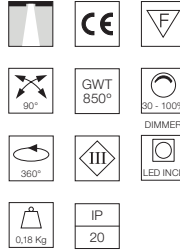
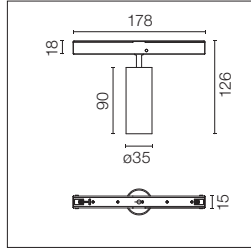

LED-Modul für Akzentbeleuchtung zur Installation in das System The Tracking Magnet.
Für die kabellose Steuerung der Leuchten sind die integrierten Casambi-Versionen auszuwählen.

Accent lighting LED module to be installed in The Tracking Magnet System.
For wireless lighting control, choose integrated Casambi versions.

Inkludiertes Zubehör (Honeycomb und Blendschutzgitter) außer dem Chrom-Finish.

Accessories included (honeycomb and screening crosspiece) except for the chrome finish.

2700K

On board dimmer

- 03.8042.40A
- 03.8042.05A
- 03.8042.14A
- *Dali2 Version
- 03.8042.40ADA
- 03.8042.05ADA
- 03.8042.14ADA

*1-10V

- 03.8042.40A1V
- 03.8042.05A1V
- 03.8042.14A1V

**Casambi integrated

- 03.8042.40ACB
- 03.8042.05ACB
- 03.8042.14ACB

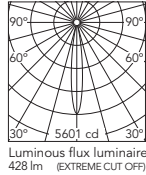

Beam Angle: 14°

h(m)	E(lx)	D(m)
1	5601	0.25
2	1400	0.49
3	622	0.74
4	350	0.98
5	224	1.23

Luminous flux luminaire
428 lm (EXTREME CUT OFF)

3000K

On board dimmer

- 03.8043.40A
- 03.8043.05A
- 03.8043.14A
- *Dali2 Version
- 03.8043.40ADA
- 03.8043.05ADA
- 03.8043.14ADA

*1-10V

- 03.8043.40A1V
- 03.8043.05A1V
- 03.8043.14A1V

**Casambi integrated

- 03.8043.40ACB
- 03.8043.05ACB
- 03.8043.14ACB

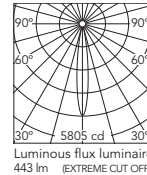

Beam Angle: 14°

h(m)	E(lx)	D(m)
1	5805	0.25
2	1451	0.49
3	645	0.74
4	363	0.98
5	232	1.23

Luminous flux luminaire
443 lm (EXTREME CUT OFF)

2700K

On board dimmer

- 03.8044.40A
- 03.8044.05A
- 03.8044.14A
- *Dali2 Version
- 03.8044.40ADA
- 03.8044.05ADA
- 03.8044.14ADA

*1-10V

- 03.8044.40A1V
- 03.8044.05A1V
- 03.8044.14A1V

**Casambi integrated

- 03.8044.40ACB
- 03.8044.05ACB
- 03.8044.14ACB

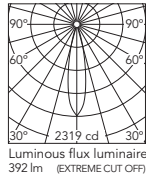

Beam Angle: 22°

h(m)	E(lx)	D(m)
1	2319	0.38
2	580	0.77
3	258	1.15
4	145	1.54
5	93	1.92

Luminous flux luminaire
392 lm (EXTREME CUT OFF)

3000K

On board dimmer

- 03.8045.40A
- 03.8045.05A
- 03.8045.14A
- *Dali2 Version
- 03.8045.40ADA
- 03.8045.05ADA
- 03.8045.14ADA

*1-10V

- 03.8045.40A1V
- 03.8045.05A1V
- 03.8045.14A1V

**Casambi integrated

- 03.8045.40ACB
- 03.8045.05ACB
- 03.8045.14ACB

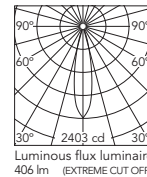

Beam Angle: 22°

h(m)	E(lx)	D(m)
1	2403	0.38
2	601	0.77
3	267	1.15
4	150	1.54
5	96	1.92

Luminous flux luminaire
406 lm (EXTREME CUT OFF)

* Nur mit der Profilverision DALI, 1-10V kompatibel / Only compatible with DALI, 1-10V profile version .

** Die Steuerung bei den Casambi-Leuchten erfolgt direkt und individuell kabellos mittels der App FLOS Control® powered by Casambi / The control system with the Casambi version of light fixtures is directly and individually regulated wirelessly using the application FLOS Control® by Casambi.

THE TRACKING MAGNET – LIGHT MODULES

Spot 120

Light Source: Power LED 12W - 724 lm - 2700K/CRI 90 / 12W - 779 lm - 3000K/CRI 90

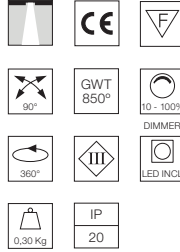
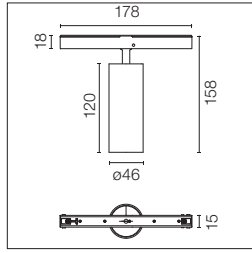

LED-Modul für Akzentbeleuchtung zur Installation in das System The Tracking Magnet.
Für die kabellose Steuerung der Leuchten sind die integrierten Casambi-Versionen auszuwählen.

Accent lighting LED module to be installed in The Tracking Magnet System.
For wireless lighting control, choose integrated Casambi versions.

Inkludiertes Zubehör (Honeycomb und Blendschutzgitter) außer dem Chrom-Finish.

Accessories included (honeycomb and screening crosspiece) except for the chrome finish.

2700K

On board dimmer

- 03.8052.40A
- 03.8052.05A
- 03.8052.14A
- *Dali2 Version
- 03.8052.40ADA
- 03.8052.05ADA
- 03.8052.14ADA

*1-10V

- 03.8052.40A1V
- 03.8052.05A1V
- 03.8052.14A1V

**Casambi integrated

- 03.8052.40ACB
- 03.8052.05ACB
- 03.8052.14ACB

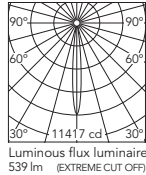

Beam Angle: 11°			
h(m)	E(lx)	D(m)	
1	11417	0.19	
2	2854	0.37	
3	1269	0.56	
4	714	0.75	
5	457	0.93	

Luminous flux luminaire
539 lm (EXTREME CUT OFF)

3000K

On board dimmer

- 03.8053.40A
- 03.8053.05A
- 03.8053.14A
- *Dali2 Version
- 03.8053.40ADA
- 03.8053.05ADA
- 03.8053.14ADA

*1-10V

- 03.8053.40A1V
- 03.8053.05A1V
- 03.8053.14A1V

**Casambi integrated

- 03.8053.40ACB
- 03.8053.05ACB
- 03.8053.14ACB

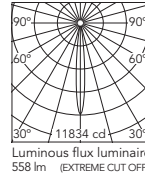

Beam Angle: 11°			
h(m)	E(lx)	D(m)	
1	11834	0.19	
2	2958	0.37	
3	1315	0.56	
4	740	0.75	
5	473	0.93	

Luminous flux luminaire
558 lm (EXTREME CUT OFF)

2700K

On board dimmer

- 03.8054.40A
- 03.8054.05A
- 03.8054.14A
- *Dali2 Version
- 03.8054.40ADA
- 03.8054.05ADA
- 03.8054.14ADA

*1-10V

- 03.8054.40A1V
- 03.8054.05A1V
- 03.8054.14A1V

**Casambi integrated

- 03.8054.40ACB
- 03.8054.05ACB
- 03.8054.14ACB

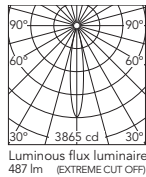

Beam Angle: 17°			
h(m)	E(lx)	D(m)	
1	3865	0.29	
2	966	0.59	
3	429	0.88	
4	242	1.18	
5	155	1.47	

Luminous flux luminaire
487 lm (EXTREME CUT OFF)

3000K

On board dimmer

- 03.8055.40A
- 03.8055.05A
- 03.8055.14A
- *Dali2 Version
- 03.8055.40ADA
- 03.8055.05ADA
- 03.8055.14ADA

*1-10V

- 03.8055.40A1V
- 03.8055.05A1V
- 03.8055.14A1V

**Casambi integrated

- 03.8055.40ACB
- 03.8055.05ACB
- 03.8055.14ACB

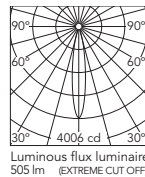

Beam Angle: 17°			
h(m)	E(lx)	D(m)	
1	4006	0.29	
2	1001	0.59	
3	445	0.88	
4	250	1.18	
5	160	1.47	

Luminous flux luminaire
505 lm (EXTREME CUT OFF)

* Nur mit der Profilverision DALI, 1-10V kompatibel / Only compatible with DALI, 1-10V profile version .

** Die Steuerung bei den Casambi-Leuchten erfolgt direkt und individuell kabellos mittels der App FLOS Control® powered by Casambi / The control system with the Casambi version of light fixtures is directly and individually regulated wirelessly using the application FLOS Control® by Casambi.

THE TRACKING MAGNET – LIGHT MODULES

Spot 120

Light Source: LED Array 12,5W - 1075 lm - 2700K/CRI 90 / 12,5W - 1138 lm - 3000K/CRI 90

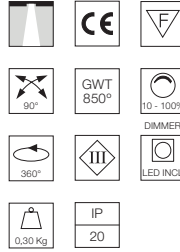
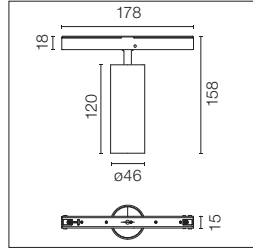

LED-Modul für Akzentbeleuchtung zur Installation in das System The Tracking Magnet.
Für die kabellose Steuerung der Leuchten sind die integrierten Casambi-Versionen auszuwählen.

Accent lighting LED module to be installed in The Tracking Magnet System.
For wireless lighting control, choose integrated Casambi versions.

Inkludiertes Zubehör (Honeycomb und Blendschutzgitter) außer dem Chrom-Finish.

Accessories included (honeycomb and screening crosspiece) except for the chrome finish.

2700K

On board dimmer

- 03.8154.40
- 03.8154.05
- 03.8154.14
- *Dali2 Version
- 03.8154.40ADA
- 03.8154.05ADA
- 03.8154.14ADA

*1-10V

- 03.8154.40.1V
- 03.8154.05.1V
- 03.8154.14.1V

**Casambi integrated

- 03.8154.40.CB
- 03.8154.05.CB
- 03.8154.14.CB

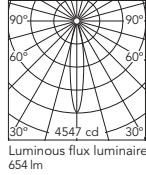

Beam Angle: 17°

h(m)	E(lx)	D(m)
1	4547	0.31
2	1137	0.61
3	505	0.92
4	284	1.23
5	182	1.53

3000K

On board dimmer

- 03.8155.40
- 03.8155.05
- 03.8155.14
- *Dali2 Version
- 03.8155.40ADA
- 03.8155.05ADA
- 03.8155.14ADA

*1-10V

- 03.8155.40.1V
- 03.8155.05.1V
- 03.8155.14.1V

**Casambi integrated

- 03.8155.40.CB
- 03.8155.05.CB
- 03.8155.14.CB

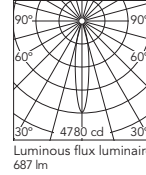

Beam Angle: 17°

h(m)	E(lx)	D(m)
1	4780	0.31
2	1195	0.61
3	531	0.92
4	299	1.23
5	191	1.53

2700K

On board dimmer

- 03.8156.40
- 03.8156.05
- 03.8156.14
- *Dali2 Version
- 03.8156.40ADA
- 03.8156.05ADA
- 03.8156.14ADA

*1-10V

- 03.8156.40.1V
- 03.8156.05.1V
- 03.8156.14.1V

**Casambi integrated

- 03.8156.40.CB
- 03.8156.05.CB
- 03.8156.14.CB

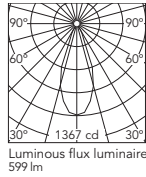

Beam Angle: 40°

h(m)	E(lx)	D(m)
1	1367	0.73
2	342	1.45
3	152	2.18
4	85	2.91
5	55	3.64

3000K

On board dimmer

- 03.8157.40
- 03.8157.05
- 03.8157.14
- *Dali2 Version
- 03.8157.40ADA
- 03.8157.05ADA
- 03.8157.14ADA

*1-10V

- 03.8157.40.1V
- 03.8157.05.1V
- 03.8157.14.1V

**Casambi integrated

- 03.8157.40.CB
- 03.8157.05.CB
- 03.8157.14.CB

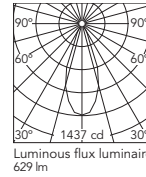

Beam Angle: 40°

h(m)	E(lx)	D(m)
1	1437	0.73
2	359	1.45
3	160	2.18
4	90	2.91
5	57	3.64

* Nur mit der Profilverision DALI, 1-10V kompatibel / Only compatible with DALI, 1-10V profile version .

** Die Steuerung bei den Casambi-Leuchten erfolgt direkt und individuell kabellos mittels der App FLOS Control® powered by Casambi / The control system with the Casambi version of light fixtures is directly and individually regulated wirelessly using the application FLOS Control® by Casambi.

THE TRACKING MAGNET – LIGHT MODULES

Spot 150

Light Source: LED Array 22,5W - 2000 lm - 2700K/CRI 90 / 22,5W - 2115 lm - 3000K/CRI 90

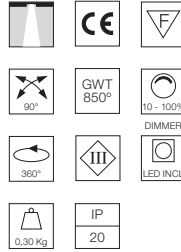
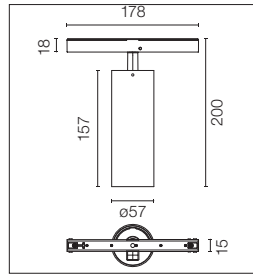

LED-Modul für Akzentbeleuchtung zur Installation in das System The Tracking Magnet.
Für die kabellose Steuerung der Leuchten sind die integrierten Casambi-Versionen auszuwählen.

Accent lighting LED module to be installed in The Tracking Magnet System.
For wireless lighting control, choose integrated Casambi versions.

2700K

On board dimmer

- 03.8072.40
- 03.8072.05
- 03.8072.14

*Dali2 Version

- 03.8072.40ADA
- 03.8072.05ADA
- 03.8072.14ADA

*1-10V

- 03.8072.40.1V
- 03.8072.05.1V
- 03.8072.14.1V

**Casambi integrated

- 03.8072.40.CB
- 03.8072.05.CB
- 03.8072.14.CB

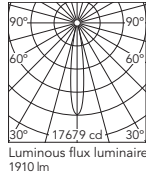

Beam Angle: 16°

h(m)	E(lx)	D(m)
1	17679	0.28
2	4420	0.56
3	1964	0.84
4	1105	1.12
5	707	1.40

Luminous flux luminaire 1910 lm

3000K

On board dimmer

- 03.8073.40
- 03.8073.05
- 03.8073.14

*Dali2 Version

- 03.8073.40ADA
- 03.8073.05ADA
- 03.8073.14ADA

*1-10V

- 03.8073.40.1V
- 03.8073.05.1V
- 03.8073.14.1V

**Casambi integrated

- 03.8073.40.CB
- 03.8073.05.CB
- 03.8073.14.CB

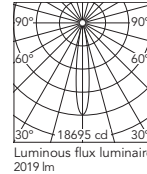

Beam Angle: 16°

h(m)	E(lx)	D(m)
1	18695	0.28
2	4674	0.56
3	2077	0.84
4	1168	1.12
5	748	1.40

Luminous flux luminaire 2019 lm

2700K

On board dimmer

- 03.8074.40
- 03.8074.05
- 03.8074.14

*Dali2 Version

- 03.8074.40ADA
- 03.8074.05ADA
- 03.8074.14ADA

*1-10V

- 03.8074.40.1V
- 03.8074.05.1V
- 03.8074.14.1V

**Casambi integrated

- 03.8074.40.CB
- 03.8074.05.CB
- 03.8074.14.CB

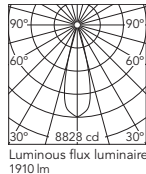

Beam Angle: 28°

h(m)	E(lx)	D(m)
1	8828	0.50
2	2207	1.00
3	981	1.50
4	552	2.00
5	353	2.50

Luminous flux luminaire 1910 lm

3000K

On board dimmer

- 03.8075.40
- 03.8075.05
- 03.8075.14

*Dali2 Version

- 03.8075.40ADA
- 03.8075.05ADA
- 03.8075.14ADA

*1-10V

- 03.8075.40.1V
- 03.8075.05.1V
- 03.8075.14.1V

**Casambi integrated

- 03.8075.40.CB
- 03.8075.05.CB
- 03.8075.14.CB

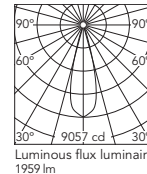

Beam Angle: 28°

h(m)	E(lx)	D(m)
1	9057	0.50
2	2264	1.00
3	1006	1.50
4	566	2.00
5	362	2.50

Luminous flux luminaire 1959 lm

2700K

On board dimmer

- 03.8076.40
- 03.8076.05
- 03.8076.14

*Dali2 Version

- 03.8076.40ADA
- 03.8076.05ADA
- 03.8076.14ADA

*1-10V

- 03.8076.40.1V
- 03.8076.05.1V
- 03.8076.14.1V

**Casambi integrated

- 03.8076.40.CB
- 03.8076.05.CB
- 03.8076.14.CB

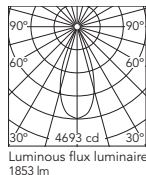

Beam Angle: 40°

h(m)	E(lx)	D(m)
1	4693	0.73
2	1173	1.46
3	521	2.18
4	293	2.91
5	188	3.64

Luminous flux luminaire 1853 lm

3000K

On board dimmer

- 03.8077.40
- 03.8077.05
- 03.8077.14

*Dali2 Version

- 03.8077.40ADA
- 03.8077.05ADA
- 03.8077.14ADA

*1-10V

- 03.8077.40.1V
- 03.8077.05.1V
- 03.8077.14.1V

**Casambi integrated

- 03.8077.40.CB
- 03.8077.05.CB
- 03.8077.14.CB

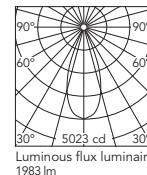

Beam Angle: 40°

h(m)	E(lx)	D(m)
1	5023	0.73
2	1256	1.46
3	558	2.18
4	314	2.91
5	201	3.64

Luminous flux luminaire 1983 lm

* Nur mit der Profiversion DALI, 1-10V kompatibel / Only compatible with DALI, 1-10V profile version.

** Die Steuerung bei den Casambi-Leuchten erfolgt direkt und individuell kabellos mittels der App FLOS Control® powered by Casambi / The control system with the Casambi version of light fixtures is directly and individually regulated wirelessly using the application FLOS Control® by Casambi.

THE TRACKING MAGNET – LIGHT MODULES

Anthony Spot Track By Antonio Citterio

Light Source: LED Array 16,5W - 1620 lm - 2700K/CRI 90 / 16,5W - 1730 lm - 3000K/CRI 90

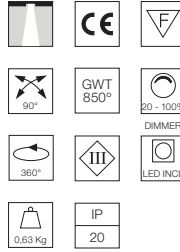
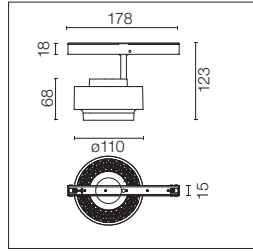

LED-Modul für Akzentbeleuchtung zur Installation in das System The Tracking Magnet.
Für die kabellose Steuerung der Leuchten sind die integrierten Casambi-Versionen auszuwählen.

Accent lighting LED module to be installed in The Tracking Magnet System.
For wireless lighting control, choose integrated Casambi versions.

Siehe erhältliches Zubehör.

See available accessories.

2700K

On board dimmer

- 03.8025.40
- 03.8025.05
- 03.8025.14
- *Dali2 Version
- 03.8025.40ADA
- 03.8025.05ADA
- 03.8025.14ADA

*1-10V

- 03.8025.40.1V
- 03.8025.05.1V
- 03.8025.14.1V

**Casambi integrated

- 03.8025.40.CB
- 03.8025.05.CB
- 03.8025.14.CB

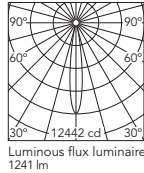

Beam Angle: 15°		
h(m)	E(lx)	D(m)
1	12442	0.27
2	3110	0.54
3	1382	0.81
4	778	1.07
5	498	1.34

3000K

On board dimmer

- 03.8027.40
- 03.8027.05
- 03.8027.14
- *Dali2 Version
- 03.8027.40ADA
- 03.8027.05ADA
- 03.8027.14ADA

*1-10V

- 03.8027.40.1V
- 03.8027.05.1V
- 03.8027.14.1V

**Casambi integrated

- 03.8027.40.CB
- 03.8027.05.CB
- 03.8027.14.CB

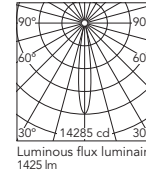

Beam Angle: 15°		
h(m)	E(lx)	D(m)
1	14285	0.27
2	3571	0.54
3	1587	0.81
4	893	1.07
5	571	1.34

2700K

On board dimmer

- 03.8026.40
- 03.8026.05
- 03.8026.14
- *Dali2 Version
- 03.8026.40ADA
- 03.8026.05ADA
- 03.8026.14ADA

*1-10V

- 03.8026.40.1V
- 03.8026.05.1V
- 03.8026.14.1V

**Casambi integrated

- 03.8026.40.CB
- 03.8026.05.CB
- 03.8026.14.CB

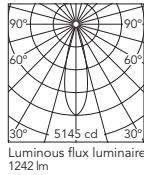

Beam Angle: 28°		
h(m)	E(lx)	D(m)
1	5145	0.49
2	1286	0.98
3	572	1.47
4	322	1.97
5	206	2.46

3000K

On board dimmer

- 03.8028.40
- 03.8028.05
- 03.8028.14
- *Dali2 Version
- 03.8028.40ADA
- 03.8028.05ADA
- 03.8028.14ADA

*1-10V

- 03.8028.40.1V
- 03.8028.05.1V
- 03.8028.14.1V

**Casambi integrated

- 03.8028.40.CB
- 03.8028.05.CB
- 03.8028.14.CB

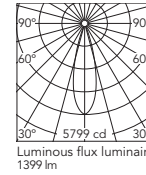

Beam Angle: 28°		
h(m)	E(lx)	D(m)
1	5799	0.49
2	1450	0.98
3	644	1.47
4	362	1.97
5	232	2.46

* Nur mit der Profiversion DALI, 1-10V kompatibel / Only compatible with DALI, 1-10V profile version.

** Die Steuerung bei den Casambi-Leuchten erfolgt direkt und individuell kabellos mittels der App FLOS Control® powered by Casambi / The control system with the Casambi version of light fixtures is directly and individually regulated wirelessly using the application FLOS Control® by Casambi.

THE TRACKING MAGNET – LIGHT MODULES

Wallee Designed By Niels Bendtsen

Light Source: Top LED 10W - 773 lm - 2700K/CRI 90 / 10W - 818 lm - 3000K/CRI 90

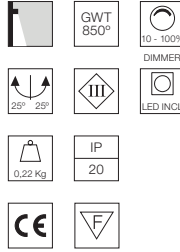
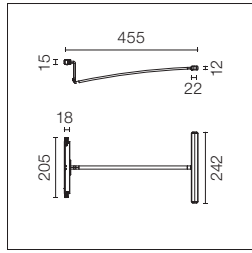

LED-Modul zur Installation in das System The Tracking Magnet. Für die kabellose Steuerung der Leuchten sind die integrierten Casambi-Versionen auszuwählen.

Die Montage von Wallee erfordert u.U. manuelle Justierung durch den Kunden/Monteuer. Informationen dazu finden Sie in der Gebrauchsanweisung. Nur zulässig für horizontale und Einbau-Installation mit Tracking Magnet. Rahmenhalterung für bis zu 5 kg inbegriffen.

Lighting LED module to be installed in The Tracking Magnet System. For wireless lighting control, choose integrated Casambi versions.

When installing Wallee, it may require a manual adjustment by the client/installer. Find information on how to carry out this adjustment in the instruction sheets. Only allowed with Tracking Magnet Recessed and horizontal installation. Includes frame holder up to 5kg.

2700K

On board dimmer

03.8090.40

03.8090.14

*Dali2 Version

03.8090.40ADA

03.8090.14ADA

*1-10V

03.8090.40.1V

03.8090.14.1V

**Casambi integrated

03.8090.40.CB

03.8090.14.CB

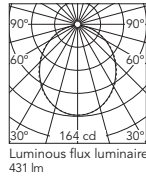

Beam Angle: 103°

h(m)	E(lx)	D(m)
1	164	2.50
2	41	5.00
3	18	7.49
4	10	9.99
5	7	12.49

Luminous flux luminaire
431 lm

3000K

On board dimmer

03.8091.40

03.8091.14

*Dali2 Version

03.8091.40ADA

03.8091.14ADA

*1-10V

03.8091.40.1V

03.8091.14.1V

**Casambi integrated

03.8091.40.CB

03.8091.14.CB

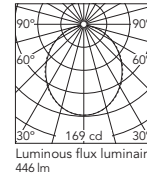





Beam Angle: 103°

h(m)	E(lx)	D(m)
1	169	2.50
2	42	5.00
3	19	7.49
4	11	9.99
5	7	12.49



Luminous flux luminaire
446 lm

Zubehör / Accessories

Spot 150***

Querabschirmung.	Screening crosspiece.		08.8429.00
Elliptische linse.	Elliptical lens.		08.8431.00
Floodlinse.	Flood lens.		08.8432.00
Honeycomb.	Honeycomb.		08.8428.00
Konische abschirmung.	Snoot shielding cone.		08.0526.00 08.0526.40 08.0526.BW

Anthony Spot

Elliptische Linse.	Elliptical lens.		08.8418.68A
Honeycomb.	Honeycomb.		08.8419.14A
Floodlinse. Zum Erreichen von Flood-Optik (35°), Anthony Spot Medium + Flood-Linse bestellen.	Flood lens. To obtain flood optics (35°) order Anthony Spot Medium + flood lens.		08.0050.00

* Nur mit der Profiversion DALI, 1-10V kompatibel / Only compatible with DALI, 1-10V profile version .

** Die Steuerung bei den Casambi-Leuchten erfolgt direkt und individuell kabellos mittels der App FLOS Control® powered by Casambi / The control system with the Casambi version of light fixtures is directly and individually regulated wirelessly using the application FLOS Control® by Casambi.

*** Außer dem Chrom-Finish

Treiber / Drivers

LED-Netzteil für Ferninstallation
48V/320W. 100/240 Vac.

LED power supply source for remote
installation, 48V/320W. 100/240 Vac.

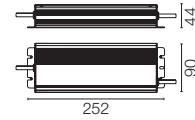

***60.8919

LED-Netzteil für Ferninstallation
110Vac-135W / 220Vac-200W.

LED power supply source for
remote installation,
110Vac-135W / 220Vac-200W.

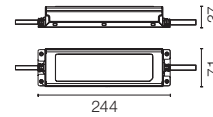

***60.9607

Dimmbarer Steuerkasten 1-10V,
48V. Notwendig, um passive (sink)
1-10V Steuerungssysteme in aktive
(source) zu verwandeln.
Für Ferninstallation.

Dimmable control box 1-10V, 48V.
Necessary to transform sink 1-10V
control systems into source ones.
For remote installation.

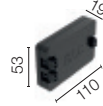

■ 08.0613.14A

Ein aktives Steuerungssystem (SOURCE) ist erforderlich und der Datenbus muss direkt am Profil angeschlossen sein. Für passive Systeme (SINK) ist eine Steuereinheit Dimming BOX erforderlich, die zwischen der Steuereinheit und dem Profil angebracht ist. / An active control system (SOURCE) is required and the data bus must be connected directly to the profile. For passive systems (SINK), a Dimming BOX Control unit is required (located between the control unit and the profile).

Multifunktionales Smart Device.
Dreifachfunktionalität 3x1: Casambi
Signalverstärker, Lichtsensor und
Präsenzmelder.
FLOS Control® by Casambi.

Multifunction Smart Device.
Triple functionality 3x1: Casambi
signal repeater, light sensor and
presence detector.
FLOS Control® by Casambi.

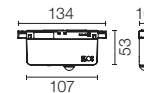

□ 06.1988.40
■ 06.1988.14

The Tracking Magnet Suspension Up&Down version

DALI Push 48V PWM-Treiber für
indirekte Lichtsteuerung (UP).

DALI Push 48V PWM Uplight
dimmer for controlling indirect
lighting (UP).



60.9678

Treiber 1-10V Push 48V PWM für
indirekte Lichtsteuerung (UP).

1-10V Push 48V PWM Uplight
dimmer for controlling indirect
lighting (UP).

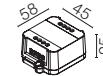

60.9395

*** Bei der Dimensionierung der Anlage ist eine Sicherheitsspanne von 15 % der maximalen Leistung der LED-Stromversorgung einzuhalten. / For the sizing of the installation keep a safety margin of 15% of the maximum power of the LED power source.

THE TRACKING POWER
DESIGNED BY FLOS ARCHITECTURAL

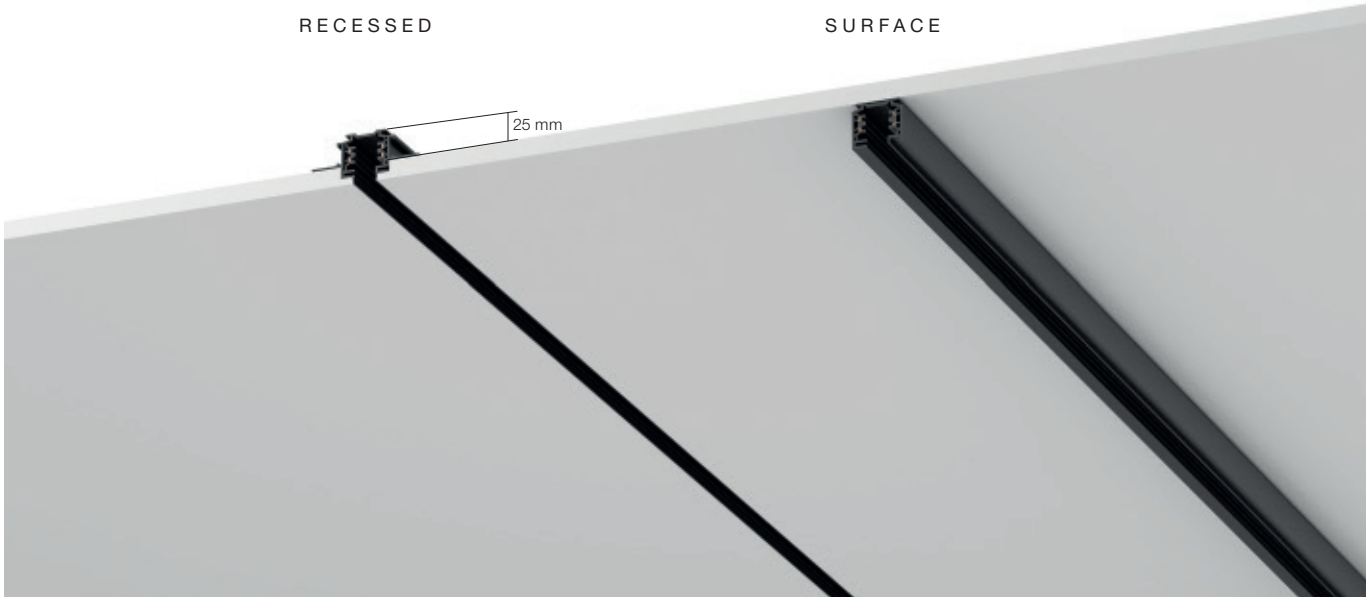

Recessed Profiles 14 Schwarz
 14 Black

Surface Profiles 40 Weiss
 40 White 14 Schwarz
 14 Black

LIGHT MODULES

UT PRO
150



LIGHT SOURCE
LED ARRAY
23,5W
2400 lm
3000K/CRI 80
1950 lm
3000K/CRI 90
2150 lm
4000K/CRI 90

UT PRO
175



LIGHT SOURCE
LED ARRAY
35,3W
4145 lm
3000K/CRI 80
3425 lm
3000K/CRI 90
3569 lm
4000K/CRI 90

UT PRO
175 LENS



LIGHT SOURCE
LED ARRAY
35,3W
3950 lm
3000K/CRI 80
3250 lm
3000K/CRI 90
3400 lm
4000K/CRI 90

UT PRO
WALL-WASHER



LIGHT SOURCE
TOP LED
25,5W
2700 lm
3000K/CRI 90
2900 lm
4000K/CRI 90

UT PRO
150 GA-69



LIGHT SOURCE
LED ARRAY
23,5W
2300 lm
3000K/CRI 80
1950 lm
3000K/CRI 90
2009 lm
4000K/CRI 90

UT PRO
175 GA-69



LIGHT SOURCE
LED ARRAY
35,3W
4145 lm
3000K/CRI 80
3425 lm
3000K/CRI 90
3569 lm
4000K/CRI 90

UT PRO
175 LENS
GA-69



LIGHT SOURCE
LED ARRAY
35,3W
3950 lm
3000K/CRI 80
3250 lm
3000K/CRI 90
3400 lm
4000K/CRI 90

UT PRO
WALL-WASHER
GA-69



LIGHT SOURCE
TOP LED
25,5W
2700 lm
3000K/CRI 90
2900 lm
4000K/CRI 90

THE TRACKING POWER

Produktbeschreibung

Exklusives Drei-Phasen-Profil zur Innenbeleuchtung, in die Decke eingelassen, das sich dank seiner Unauffälligkeit vollständig in die Architektur integriert.

Die Konstruktionsprofile von Tracking Power wurden aus schwarzem, extrudiertem Aluminium gefertigt und besitzen elektrische Leitungen, an denen die Leuchten mit dem exklusiven FLOS Befestigungssystem installiert werden. Ist die Schiene erst installiert, bleibt lediglich eine Linie von nur 15 mm Dicke sichtbar.

Die Familie Tracking Power erstreckt sich auf eine breite Palette von Projektoren, die in Verbindung mit einer exklusiven Elektronik, die in den Leuchtenkörper integriert ist, unnötiges Volumen beseitigen und dadurch eine großartige Integration ermöglichen.

Verfügbare Lösungen für Standard-Dreiphasenprofile, keine Fernsteuerung möglich.

Optisches System

Die Lichtmodule PRO 150 und UT Pro 175 sind in Spot, Medium und Flood Optik erhältlich und besitzen einen hocheffizienten Reflektor aus Borosilikatglas.

Im Lichtmodul UT Pro 175 Lens ist eine verstellbare Linse integriert, mit der man den Öffnungswinkel von 13° bis 56° verändern kann.

Das Lichtmodul UT Pro Wall-Washer sorgt als hochqualitative Wandeinbauleuchte für eine gleichmäßige Lichtverteilung.

Zubehör

Querabschirmung, elliptische Linse, Flood und Honeycomb Linse für die Module zur Akzentbeleuchtung UT Pro 150 und UT Pro 175 erhältlich.

Zusatzinformationen

Alle Leuchten sind ausgestattet mit einem Adapter geringer Abmessung, der speziell für den Gebrauch in FLOS Tracking Power Profilen entworfen wurde, und sich nach dem Einbau vollkommen ins Profil integriert. Leuchten mit Standardadapter Nordic GA69 zum Einbau in FLOS Standard-Dreiphasenschienen erhältlich. Kompatibilität mit Dreiphasenschienen der Hersteller Nordic, Eutrac, Erco, Zumtobel und iGuzzini ist gewährleistet.

Außerdem sind alle Leuchten als Surface Version erhältlich für den flächenbündigen Einbau in die Decke.

- UT Pro 150, UT Pro 175, UT Pro 175 Lens:

360° vertikale und 90° horizontale Drehung möglich.

Einrastmechanismus für die horizontale Achse integriert.

Schutzgrad IP20.

- UT Pro Wall-Washer:

360° vertikale und 15° horizontale Drehung möglich.

Dali-Version mit GA-600-Adapter verfügbar.

Schutzgrad IP20.

- Profile:

Nur auf Flächen aus Gipskarton mit 12,5 mm Stärke installierbar.

Auf normal entflammaren Oberflächen einsetzbar.

Qualitätszeichen

Das Gerät entspricht der europäischen technischen Norm EN60598-1 und den entsprechenden Zusatzregelungen.

Description

Exclusive 3-phase lighting profile for indoor use in ceiling recessed version which, thanks to its low visual impact, offers a complete integration into the architecture.

Tracking Power's structural profiles are manufactured in black extruded aluminium, fitted with electric tracks where luminaires are installed using the exclusive Flos mounting system.

Once the track has been installed, only a 15 mm thick line is noticeable.

The Tracking Power family is completed with a wide range of projectors which, combined with exclusive electronics integrated into the body of the luminaire, eliminate unnecessary volume and, as a result, have greater integration.

Standard 3-phase tracks solutions available, cannot be remotely dimmed.

Optic System

Light modules UT Pro 150 and UT Pro 175 are available with spot, medium and flood optics and a built-in high-efficiency borosilicate glass reflector.

The light module UT Pro 175 Lens incorporates an adjustable lens which allows regulating the opening angle from 13° to 56°.

The light module UT Pro Wall-Washer brings a uniform light distribution in a high-performance wall-washer.

Accessories

Shielding cylinder, elliptical lens, flood and honeycomb lens for accent lighting modules UT Pro 150 and UT Pro 175 available.

Additional Information

All luminaires have incorporated a small adapter that, once installed, is completely integrated within the profile, especially designed for FLOS profile The Tracking Power. Luminaires with standard adapter Nordic GA69 for installation in FLOS standard 3-phase tracks available. Guaranteed compatibility with 3-phase tracks manufactured by Nordic, Eutrac, Erco, Zumtobel and iGuzzini.

Moreover, all the luminaires are available in surface version allowing to be fitted flush to the ceiling.

- UT Pro 150, UT Pro 175 and UT Pro 175 Lens:

Possibility of 360° rotation in the vertical axis and 90° rotation in the horizontal axis. Blocking mechanism for horizontal axis integrated.

IP20 protection grade.

- UT Pro Wall-Washer:

Possibility of 360° rotation in vertical axis and 15° rotation in horizontal axis.

Dali version available with GA-600 adaptor.

IP20 protection grade.

- Profile:

Can only be installed in 12.5mm thick plaster-board.

Suitable for installation on normally inflammable surfaces.

Compliance of Standards and Quality Marks

EN60598-1 European Technical Standards and any subsequent additions.

HOW TO ORDER

1 CHOOSE YOUR PROFILE AND LENGTH

RECESSED PROFILE

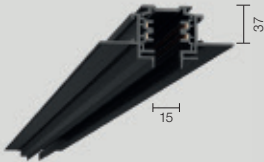

L: 1 / 2 / 3 / 4 m

2 COMPLETE WITH MOUNTING ACCESSORIES

Mains feed connector and End Cap



Right or Left

Feed 90° Corner



Right or Left
Electrical / mechanical joint

Intermediate connector



Straight

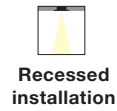

Accessories

Adjustable ceiling kit
(Optional)



SURFACE/SUSPENSION DOWN PROFILE

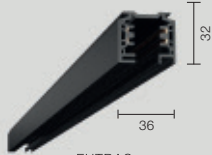

EUTRAC

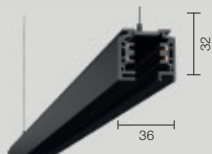

EUTRAC



L: 1 / 2 / 3 m

Mains feed connector



Right

Left

End cap



Intermediate connector



Feed 90° Corner



Earth outside



Earth inside



Accessories

Ceiling fixing kit

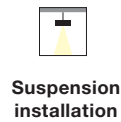

Ceiling fixing kit



+

Suspension kit



THE TRACKING POWER

3 SELECT A LIGHT MODULE

UT Pro 150



On board dimmer



S/M/F

UT Pro 175



On board dimmer



S/M/F

UT Pro 175 Lens



On board dimmer



Lens in / Lens out

UT Pro Wall-Washer



Non dimmable



Wall-Washer

UT Pro 150



On board dimmer



S/M/F

UT Pro 175



On board dimmer



S/M/F

UT Pro 175 Lens



On board dimmer



Lens in / Lens out

UT Pro Wall-Washer



Non dimmable



Wall-Washer

UT Pro 150 GA-69



On board dimmer



S/M/F

UT Pro 175 GA-69



On board dimmer



S/M/F

UT Pro 175 Lens GA-69



On board dimmer



Lens in / Lens out

UT Pro Wall-Washer GA-69



Non dimmable



Wall-Washer

THE TRACKING POWER RECESSED – PROFILES

Profile

Dreiphasen-Profil mit minimaler Auswirkung auf die Architektur (15 mm) für den Einbau in Gipskartondecken.
 Gerade Schienen sind in vier Längen erhältlich: 1 m, 2 m, 3 m und 4 m. 90°-Winkel in der gleichen Ebene (entsprechende Elemente für linke und rechte Ecken) erhältlich.
 Zum Verbinden mehrerer Profile wird ein Verbindungsstück benötigt. Versorgungsanschlüsse für die Installation auf der linken oder rechten Seite erhältlich.
 Versorgungsanschlüsse inklusive Abdeckung.
 Zur Befestigung werden die Flügel des Tracking Power Profils mithilfe von Befestigungsprofilen aus Aluminium auf der Gipskartonoberfläche angeschraubt.
 Der Befestigungssatz an absenkbarer Decke (optional) ermöglicht die Installation ohne Aluminium-Befestigungsprofile. Empfohlen für Anwendungen, bei denen zuerst das Tracking Power Profil und anschließend die absenkbare Gipskartondecke installiert werden kann.

Profiles

Three-phase profile with minimum impact on the architecture (15 mm) for embedded installations in plasterboard ceilings.
 Linear profiles available in four lengths: 1 m, 2 m, 3 m and 4 m. 90° corners on the same plane are also available (different elements for the left and right corners).
 A linear intermediate connector is required to connect several profiles. Power supply connectors available for the installation on the left or right-hand side. End caps included in the power supply connectors.
 The fastening of the Tracking Power is performed by screwing the sides of the profile to the plasterboard surface, aided by aluminium fastening profiles. The adjustable ceiling fastening kit (optional) permits the installation without the need for fastening aluminium profiles. Recommended for installations where the Tracking Power profile can be installed before the suspended plasterboard.

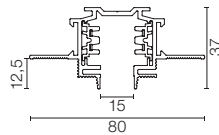
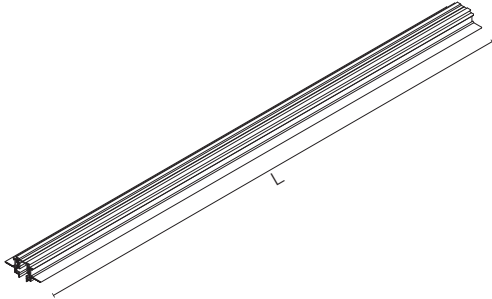

- L: 1000 mm
- 06.1800.14
- L: 2000 mm
- 06.1801.14
- L: 3000 mm
- 06.1802.14
- L: 4000 mm
- 06.1803.14

L: 1 m / 2 m / 3 m / 4 m

90° Winkel.
 Mit elektrischer Einspeisung.

90° Corner.
 With electrical feeding connection.

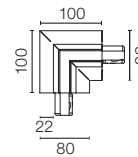

- Right
- 06.1804.14
- Left
- 06.1805.14

Versorgungsanschluss. Endkappe
 inbegriffen.

Feed connector. End cap included.

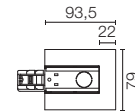

- Right
- 06.1807.14
- Left
- 06.1806.14

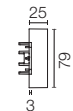

Linearer Zwischenschalter.

Intermediate linear connector.



- 60.3319.14

Befestigungssatz an absenkbarer
 decke (fakultativ). Set mit 2 stück.

Adjustable ceiling kit (optional).
 2 unit kit.

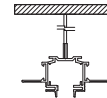

- 08.8439.14

Profile (mm)	Quantities Ceiling Kit
1000	1
2000	2
3000	3
4000	4

THE TRACKING POWER SURFACE – PROFILES

Profile

Dreiphasenschiene für EUTRAC-Standard-Oberflächeninstallationen, kompatibel mit Beleuchtungen des Tracking-Power-Systems.



L: 1 m / 2 m / 3 m



Profiles

Three-phase profile for standard EUTRAC surface installations compatible with Tracking Power light fixtures.

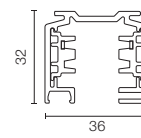
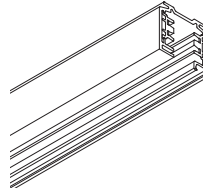

- 1000 mm
 - 60.3330.11A
 - 60.3330.14
- 2000 mm
 - 60.3331.11A
 - 60.3331.14
- 3000 mm
 - 60.3336.11A
 - 60.3336.14

Versorgungsanschluss.

Feed connector.



- Right
 - 60.3317.11A
 - 60.3317.14
- Left
 - 60.3318.11A
 - 60.3318.14

Linearer Zwischenschalter.

Intermediate linear connector.



- 60.3319.11A
- 60.3319.14

Endkappe.

End cap.



- 60.3333.11A
- 60.3333.14

90 ° Winkel.
Mit elektrischer Einspeisung.

90° Corner.
With electrical feeding connection.



- Earth Outside
 - 60.3320.11A
 - 60.3320.14
- Earth Inside
 - 60.3321.11A
 - 60.3321.14

Deckenbefestigung oder für
Aufhänge-Kit.

Ceiling fixture or fixture for
suspension kit.



- 60.3351.11A
- 60.3351.14

Aufhänge-Kit, Kabel zu 1,5 m.
Zusammen mit 60.3351 bestellen.

Suspension kit, 1,5 m cable. Order
together with 60.3351.



60.3345

THE TRACKING POWER RECESSED/SURFACE – INSTALLATION

Um die Sicherheit der Elektroinstallation zu gewährleisten, ist das Tracking Power Profil asymmetrisch konzipiert und ermöglicht eine einzigartige Weise der Installation von Lichtquellen.

In der Illustration wird die Position der Neutralschiene (rote Linie) für die verschiedenen möglichen Konfigurationen dargestellt. Sie muss den Anforderungen der jeweiligen Installation entsprechend und unter Berücksichtigung der Stromkontinuität angepasst werden.

The Tracking Power profile is asymmetric to ensure the electric safety in the installation, and it provides a unique form in the installation of luminaires.

The diagram shows the position of the neutral track (red line) for the different possible configurations, which must be composed according to the requirements for each installation, respecting the electric continuity.

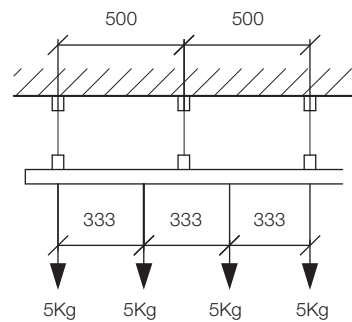
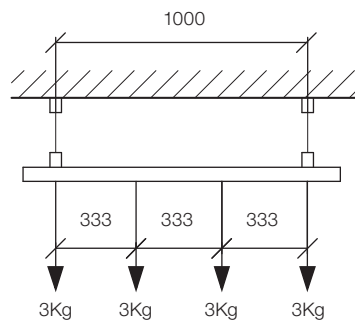
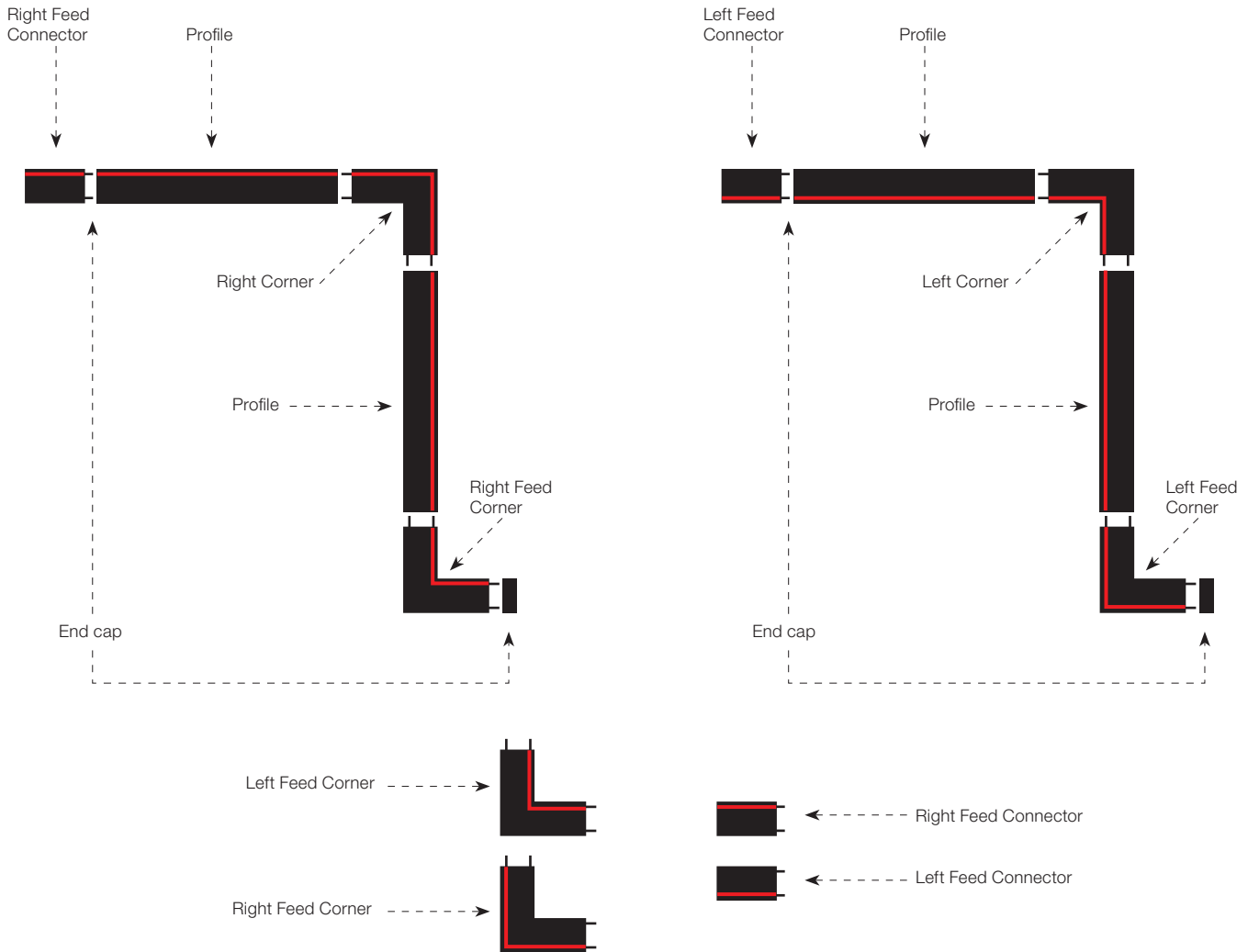

THE TRACKING POWER – LIGHT MODULES

UT Pro 150

Light Source: LED Array 23,5W - 2400 lm - 3000K/CRI 80 / 23,5W - 1950 lm - 3000K/CRI 90 / 23,5W - 2150 lm - 4000K/CRI 90

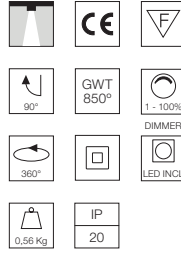
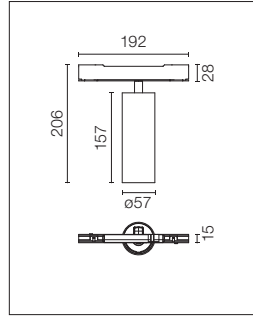

Scheinwerfer mit LED Lichtquelle zum Einbau in Tracking Power Profil. Netzgerät mit 120-277V inbegriffen. Es enthält Hochleistungsreflektor.

Spotlight to be installed in Tracking Power profile with LED light source. 120-277V power supply integrated. High performance reflector included.

Bei den Versionen 40 sind der Schienenadapter, der Arm und der Hinterkopf schwarz. Bei den "All White"-Versionen sind der Schienenadapter, der Arm, der Hinterkopf und der Kopf weiß, nur der Blendschutzring bleibt schwarz.

.40 versions come with the track adapter, the arm and the rear of the head in black. In the "All white" versions, the track adapter, the arm, the rear of the head and the head are white. Only the anti-glare ring is black.

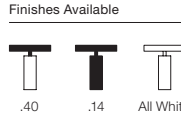

- 3000K - CRI 80**
On board dimmer
- 09.7210.40A
 - 09.7210.14A
 - All White
 - 09.7210.40A78

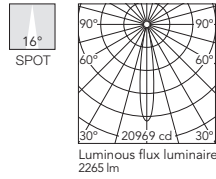

Beam Angle: 16°

h(m)	E(lx)	D(m)
1	20969	0.28
2	5242	0.56
3	2330	0.84
4	1311	1.12
5	839	1.40

- 3000K - CRI 90**
On board dimmer
- 09.7216.40A
 - 09.7216.14A
 - All White
 - 09.7216.40A78

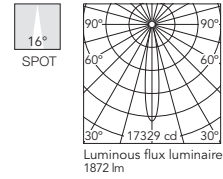

Beam Angle: 16°

h(m)	E(lx)	D(m)
1	17329	0.28
2	4332	0.56
3	1925	0.84
4	1083	1.12
5	693	1.40

- 4000K - CRI 90**
On board dimmer
- 09.7211.40A
 - 09.7211.14A
 - All White
 - 09.7211.40A78

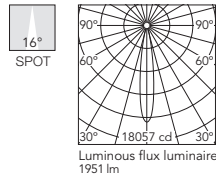

Beam Angle: 16°

h(m)	E(lx)	D(m)
1	18057	0.28
2	4514	0.56
3	2006	0.84
4	1129	1.12
5	722	1.40

- 3000K - CRI 90**
On board dimmer
- 09.7217.40A
 - 09.7217.14A
 - All White
 - 09.7217.40A78

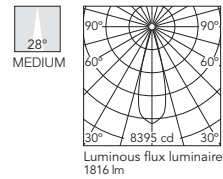

Beam Angle: 28°

h(m)	E(lx)	D(m)
1	8395	0.50
2	2099	1.00
3	933	1.50
4	525	2.00
5	336	2.50

- 3000K - CRI 80**
On board dimmer
- 09.7212.40A
 - 09.7212.14A
 - All White
 - 09.7212.40A78

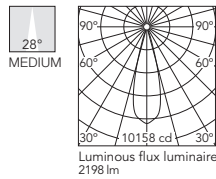

Beam Angle: 28°

h(m)	E(lx)	D(m)
1	10158	0.50
2	2540	1.00
3	1129	1.50
4	635	2.00
5	406	2.50

- 4000K - CRI 90**
On board dimmer
- 09.7213.40A
 - 09.7213.14A
 - All White
 - 09.7213.40A78

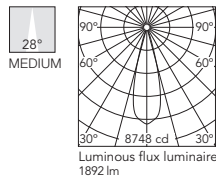

Beam Angle: 28°

h(m)	E(lx)	D(m)
1	8748	0.50
2	2187	1.00
3	972	1.50
4	547	2.00
5	350	2.50

- 3000K - CRI 80**
On board dimmer
- 09.7214.40A
 - 09.7214.14A
 - All White
 - 09.7214.40A78

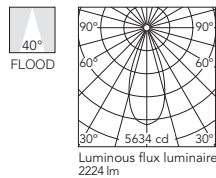

Beam Angle: 40°

h(m)	E(lx)	D(m)
1	5634	0.73
2	1408	1.46
3	626	2.18
4	352	2.91
5	225	3.64

- 3000K - CRI 90**
On board dimmer
- 09.7218.40A
 - 09.7218.14A
 - All White
 - 09.7218.40A78

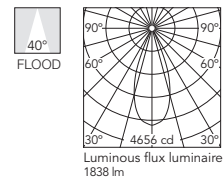

Beam Angle: 40°

h(m)	E(lx)	D(m)
1	4656	0.73
2	1164	1.46
3	517	2.18
4	291	2.91
5	186	3.64

- 4000K - CRI 90**
On board dimmer
- 09.7215.40A
 - 09.7215.14A
 - All White
 - 09.7215.40A78

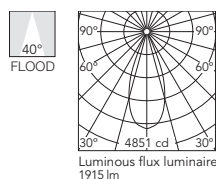

Beam Angle: 40°

h(m)	E(lx)	D(m)
1	4851	0.73
2	1213	1.46
3	539	2.18
4	303	2.91
5	194	3.64

THE TRACKING POWER – LIGHT MODULES

UT Pro 175

Light Source: LED Array 35,3W - 3950 lm - 3000K/CRI 80 / 35,3W - 3250 lm - 3000K/CRI 90 / 35,3W - 3400 lm - 4000K/CRI 90

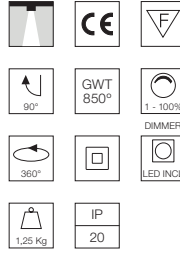
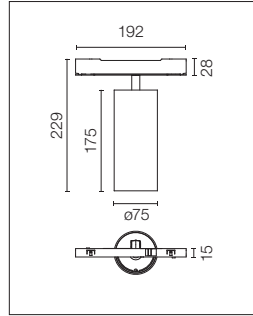

Scheinwerfer mit LED Lichtquelle zum Einbau in Tracking Power Profil. Netzgerät mit 120-277V inbegriffen. Es enthält Hochleistungsreflektor.

Spotlight to be installed in Tracking Power profile with LED light source. 120-277V power supply integrated. High performance reflector included.

Bei den Versionen 40 sind der Schienenadapter, der Arm und der Hinterkopf schwarz. Bei den "All White"-Versionen sind der Schienenadapter, der Arm, der Hinterkopf und der Kopf weiß, nur der Blendschutzring bleibt schwarz.

.40 versions come with the track adapter, the arm and the rear of the head in black. In the "All white" versions, the track adapter, the arm, the rear of the head and the head are white. Only the anti-glare ring is black.

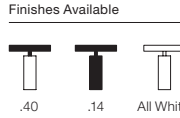

3000K - CRI 80 On board dimmer

- 09.7300.40
- 09.7300.14
- All White
- 09.7300.40.78

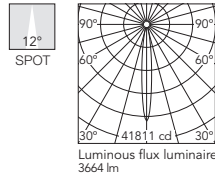

Beam Angle: 12°

h(m)	E(lx)	D(m)
1	41811	0.21
2	10453	0.41
3	4646	0.62
4	2613	0.83
5	1672	1.03

3000K - CRI 90 On board dimmer

- 09.7301.40
- 09.7301.14
- All White
- 09.7301.40.78

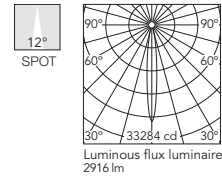

Beam Angle: 12°

h(m)	E(lx)	D(m)
1	33284	0.21
2	8321	0.41
3	3698	0.62
4	2080	0.83
5	1331	1.03

4000K - CRI 90 On board dimmer

- 09.7302.40
- 09.7302.14
- All White
- 09.7302.40.78

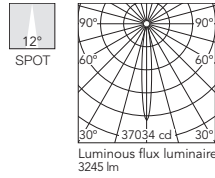

Beam Angle: 12°

h(m)	E(lx)	D(m)
1	37034	0.21
2	9258	0.41
3	4115	0.62
4	2315	0.83
5	1481	1.03

3000K - CRI 80 On board dimmer

- 09.7303.40
- 09.7303.14
- All White
- 09.7303.40.78

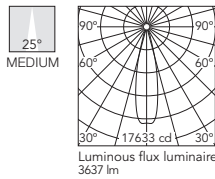

Beam Angle: 25°

h(m)	E(lx)	D(m)
1	17633	0.44
2	4408	0.88
3	1959	1.32
4	1102	1.76
5	705	2.20

3000K - CRI 90 On board dimmer

- 09.7304.40
- 09.7304.14
- All White
- 09.7304.40.78

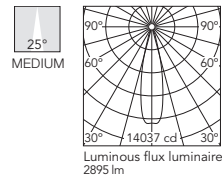

Beam Angle: 25°

h(m)	E(lx)	D(m)
1	14037	0.44
2	3509	0.88
3	1560	1.32
4	877	1.76
5	561	2.20

4000K - CRI 90 On board dimmer

- 09.7305.40
- 09.7305.14
- All White
- 09.7305.40.78

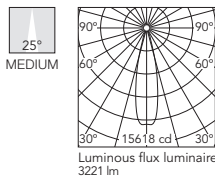

Beam Angle: 25°

h(m)	E(lx)	D(m)
1	15618	0.44
2	3904	0.88
3	1735	1.32
4	976	1.76
5	625	2.20

3000K - CRI 80 On board dimmer

- 09.7306.40
- 09.7306.14
- All White
- 09.7306.40.78

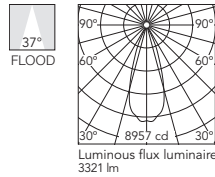

Beam Angle: 37°

h(m)	E(lx)	D(m)
1	8957	0.66
2	2239	1.32
3	995	1.98
4	560	2.65
5	358	3.31

3000K - CRI 90 On board dimmer

- 09.7307.40
- 09.7307.14
- All White
- 09.7307.40.78

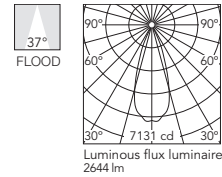

Beam Angle: 37°

h(m)	E(lx)	D(m)
1	7131	0.66
2	1783	1.32
3	792	1.98
4	446	2.65
5	285	3.31

4000K - CRI 90 On board dimmer

- 09.7308.40
- 09.7308.14
- All White
- 09.7308.40.78

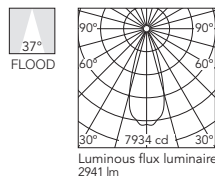

Beam Angle: 37°

h(m)	E(lx)	D(m)
1	7934	0.66
2	1983	1.32
3	882	1.98
4	496	2.65
5	317	3.31

THE TRACKING POWER – LIGHT MODULES

UT Pro 175 Lens

Light Source: LED Array 35,3W - 3950 lm - 3000K/CRI 80 / 35,3W - 3250 lm - 3000K/CRI 90 / 35,3W - 3400 lm - 4000K/CRI 90

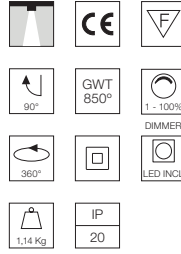
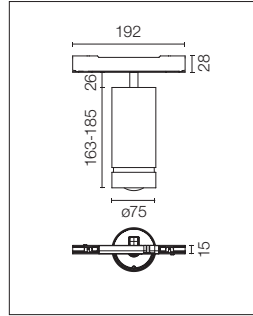

Scheinwerfer mit LED Lichtquelle zum Einbau in Tracking Power Profil. Besitzt eine verstellbare Linse, mit der man den Öffnungswinkel von 13° bis 56° verändern kann. Netzgerät mit 120-277V inbegriffen.

Spotlight to be installed in Tracking Power profile with LED light source. Includes adjustable lens allowing opening angle calibration from 13° to 56°. 120-277V power supply integrated.

Bei den Versionen 40 sind der Schienenadapter, der Arm und der Hinterkopf schwarz. Bei den "All White" -Versionen sind der Schienenadapter, der Arm, der Hinterkopf und der Kopf weiß, nur der Blendschutzring bleibt schwarz.

.40 versions come with the track adapter, the arm and the rear of the head in black. In the "All white" versions, the track adapter, the arm, the rear of the head and the head are white. Only the anti-glare ring is black.

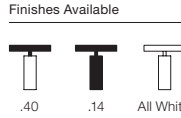

3000K - CRI 80 On board dimmer

- 09.7370.40
- 09.7370.14
- All White
- 09.7370.40.78

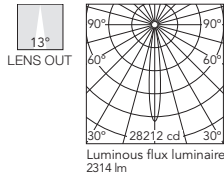

Beam Angle: 13°

h(m)	E(lx)	D(m)
1	28212	0.23
2	7053	0.46
3	3135	0.70
4	1763	0.93
5	1128	1.16

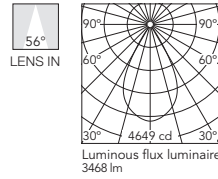

Beam Angle: 56°

h(m)	E(lx)	D(m)
1	4649	1.07
2	1162	2.14
3	517	3.21
4	291	4.29
5	186	5.36

3000K - CRI 90 On board dimmer

- 09.7371.40
- 09.7371.14
- All White
- 09.7371.40.78

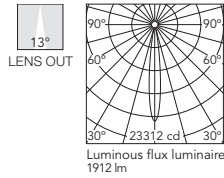

Beam Angle: 13°

h(m)	E(lx)	D(m)
1	23312	0.23
2	5828	0.46
3	2590	0.70
4	1457	0.93
5	932	1.16

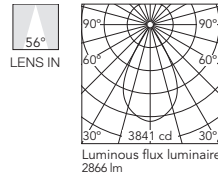

Beam Angle: 56°

h(m)	E(lx)	D(m)
1	3841	1.07
2	960	2.14
3	427	3.21
4	240	4.29
5	154	5.36

4000K - CRI 90 On board dimmer

- 09.7372.40
- 09.7372.14
- All White
- 09.7372.40.78

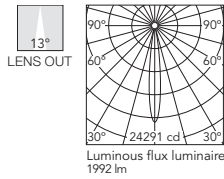

Beam Angle: 13°

h(m)	E(lx)	D(m)
1	24291	0.23
2	6073	0.46
3	2699	0.70
4	1518	0.93
5	972	1.16

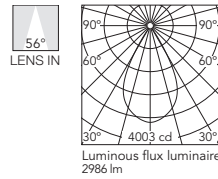

Beam Angle: 56°

h(m)	E(lx)	D(m)
1	4003	1.07
2	1001	2.14
3	445	3.21
4	250	4.29
5	160	5.36

UT Pro Wall-Washer

Light Source: Top LED 25,5W - 2700 lm - 3000K/CRI 90 / 25,5W - 2900 lm - 4000K/CRI 90

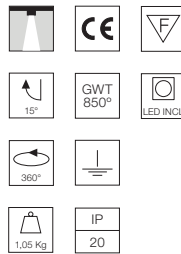
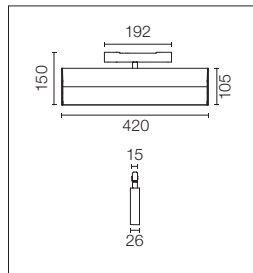

Lichtmodul Wall-Washer mit LED Lichtquelle zum Einbau in Tracking Power Profil. Netzgerät mit 220-240V inbegriffen.

Wall-Washer lighting module to be installed in Tracking Power profile with LED light source. 220-240V power supply integrated.

Bei den Versionen 40 sind der Schienenadapter, der Arm und der Hinterkopf schwarz. Bei den "All White" -Versionen sind der Schienenadapter, der Arm, der Hinterkopf und der Kopf weiß, nur der Blendschutzring bleibt schwarz.

.40 versions come with the track adapter, the arm and the rear of the head in black. In the "All white" versions, the track adapter, the arm, the rear of the head and the head are white. Only the anti-glare ring is black.



3000K - CRI 90 Non Dimmable

- 09.7500.40
- 09.7500.14
- All White
- 09.7500.40.78

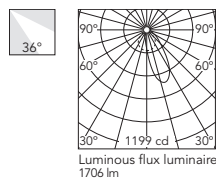

Beam Angle: 36°

h(m)	E(lx)	D(m)
1	1199	0.78
2	300	1.56
3	133	2.34
4	75	3.12
5	48	3.90

4000K - CRI 90 Non Dimmable

- 09.7501.40
- 09.7501.14
- All White
- 09.7501.40.78

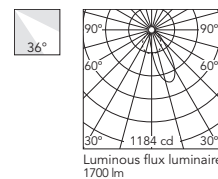

Beam Angle: 36°

h(m)	E(lx)	D(m)
1	1184	0.76
2	296	1.52
3	132	2.28
4	74	3.04
5	47	3.80

THE TRACKING POWER – LIGHT MODULES

UT Pro 150 GA-69

Light Source: LED Array 23,5W - 2300 lm - 3000K/CRI 80 / 23,5W - 1950 lm - 3000K/CRI 90 / 23,5W - 2009 lm - 4000K/CRI 90

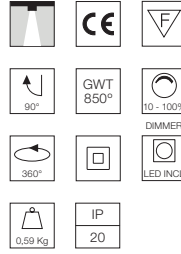
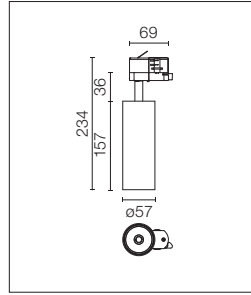

Finishes Available



Scheinwerfer mit LED Lichtquelle zum Einbau in Standard-Dreiphasenschiene. Netzgerät 120-270V inbegriffen.

Bei den Versionen 40 sind der Schienenadapter, der Arm und der Hinterkopf schwarz. Bei den "All White" -Versionen sind der Schienenadapter, der Arm, der Hinterkopf und der Kopf weiß, nur der Blendschutzring bleibt schwarz.

Spotlight to be installed in standard 3-phase track with LED light source. 120-270V power supply integrated.

.40 versions come with the track adapter, the arm and the rear of the head in black. In the "All white" versions, the track adapter, the arm, the rear of the head and the head are white. Only the anti-glare ring is black.

3000K - CRI 80 On board dimmer

- 09.7270.40A
- 09.7270.14A
- 09.7270.40A78

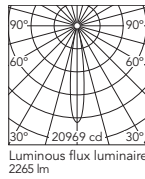

Beam Angle: 16°

h(m)	E(lx)	D(m)
1	20969	0.28
2	5242	0.56
3	2330	0.84
4	1311	1.12
5	839	1.40

Luminous flux luminaire 2265 lm

3000K - CRI 90 On board dimmer

- 09.7276.40A
- 09.7276.14A
- 09.7276.40A78

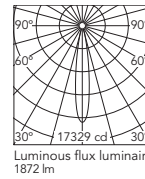

Beam Angle: 16°

h(m)	E(lx)	D(m)
1	17329	0.28
2	4332	0.56
3	1925	0.84
4	1083	1.12
5	693	1.40

Luminous flux luminaire 1872 lm

4000K - CRI 90 On board dimmer

- 09.7271.40A
- 09.7271.14A
- 09.7271.40A78

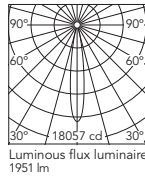

Beam Angle: 16°

h(m)	E(lx)	D(m)
1	18057	0.28
2	4514	0.56
3	2006	0.84
4	1129	1.12
5	722	1.40

Luminous flux luminaire 1951 lm

3000K - CRI 90 On board dimmer

- 09.7277.40A
- 09.7277.14A
- 09.7277.40A78

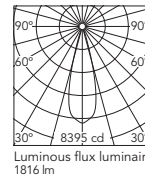

Beam Angle: 28°

h(m)	E(lx)	D(m)
1	8395	0.50
2	2099	1.00
3	933	1.50
4	525	2.00
5	336	2.50

Luminous flux luminaire 1816 lm

3000K - CRI 80 On board dimmer

- 09.7272.40A
- 09.7272.14A
- 09.7272.40A78

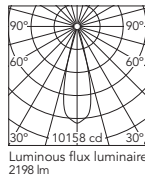

Beam Angle: 28°

h(m)	E(lx)	D(m)
1	10158	0.50
2	2540	1.00
3	1129	1.50
4	635	2.00
5	406	2.50

Luminous flux luminaire 2198 lm

4000K - CRI 90 On board dimmer

- 09.7273.40A
- 09.7273.14A
- 09.7273.40A78

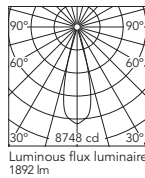

Beam Angle: 28°

h(m)	E(lx)	D(m)
1	8748	0.50
2	2187	1.00
3	972	1.50
4	547	2.00
5	350	2.50

Luminous flux luminaire 1892 lm

3000K - CRI 80 On board dimmer

- 09.7274.40A
- 09.7274.14A
- 09.7274.40A78

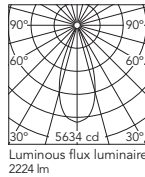

Beam Angle: 40°

h(m)	E(lx)	D(m)
1	5634	0.73
2	1408	1.46
3	626	2.18
4	352	2.91
5	225	3.64

Luminous flux luminaire 2224 lm

3000K - CRI 90 On board dimmer

- 09.7278.40A
- 09.7278.14A
- 09.7278.40A78

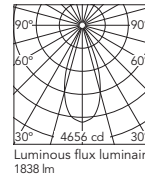

Beam Angle: 40°

h(m)	E(lx)	D(m)
1	4656	0.73
2	1164	1.46
3	517	2.18
4	291	2.91
5	186	3.64

Luminous flux luminaire 1838 lm

4000K - CRI 90 On board dimmer

- 09.7275.40A
- 09.7275.14A
- 09.7275.40A78

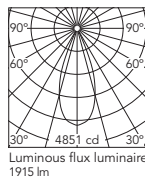

Beam Angle: 40°

h(m)	E(lx)	D(m)
1	4851	0.73
2	1213	1.46
3	539	2.18
4	303	2.91
5	194	3.64

Luminous flux luminaire 1915 lm

THE TRACKING POWER – LIGHT MODULES

UT Pro 175 GA-69

Light Source: LED Array 35,3W - 3950 lm - 3000K/CRI 80 / 35,3W - 3250 lm - 3000K/CRI 90 / 35,3W - 3400 lm - 4000K/CRI 90

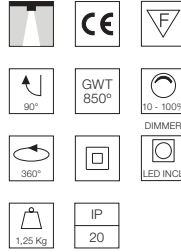
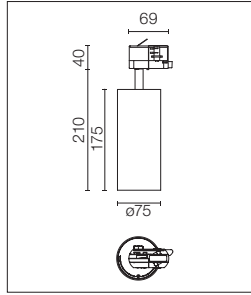

Finishes Available



Scheinwerfer mit LED Lichtquelle zum Einbau in Standard-Dreiphasenschiene. Netzgerät 120-270V inbegriffen.

Bei den Versionen 40 sind der Schienenadapter, der Arm und der Hinterkopf schwarz. Bei den "All White" -Versionen sind der Schienenadapter, der Arm, der Hinterkopf und der Kopf weiß, nur der Blendschutzring bleibt schwarz.

Spotlight to be installed in standard 3-phase track with LED light source. 120-270V power supply integrated.

.40 versions come with the track adapter, the arm and the rear of the head in black. In the "All white" versions, the track adapter, the arm, the rear of the head and the head are white. Only the anti-glare ring is black.

3000K - CRI 80 On board dimmer

- 09.7310.40
- 09.7310.14
- All White
- 09.7310.40.78

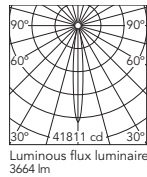

Beam Angle: 12°

h(m)	E(lx)	D(m)
1	41811	0.21
2	10453	0.41
3	4646	0.62
4	2613	0.83
5	1672	1.03

Luminous flux luminaire 3664 lm

3000K - CRI 90 On board dimmer

- 09.7311.40
- 09.7311.14
- All White
- 09.7311.40.78

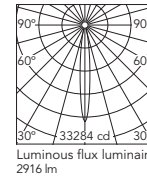

Beam Angle: 12°

h(m)	E(lx)	D(m)
1	33284	0.21
2	8321	0.41
3	3698	0.62
4	2080	0.83
5	1331	1.03

Luminous flux luminaire 2916 lm

4000K - CRI 90 On board dimmer

- 09.7312.40
- 09.7312.14
- All White
- 09.7312.40.78

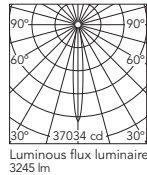

Beam Angle: 12°

h(m)	E(lx)	D(m)
1	37034	0.21
2	9258	0.41
3	4115	0.62
4	2315	0.83
5	1481	1.03

Luminous flux luminaire 3245 lm

3000K - CRI 80 On board dimmer

- 09.7313.40
- 09.7313.14
- All White
- 09.7313.40.78

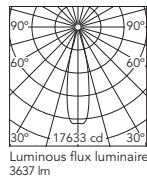

Beam Angle: 25°

h(m)	E(lx)	D(m)
1	17633	0.44
2	4408	0.88
3	1959	1.32
4	1102	1.76
5	705	2.20

Luminous flux luminaire 3637 lm

3000K - CRI 90 On board dimmer

- 09.7314.40
- 09.7314.14
- All White
- 09.7314.40.78

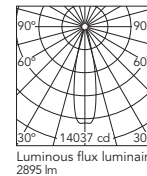

Beam Angle: 25°

h(m)	E(lx)	D(m)
1	14037	0.44
2	3509	0.88
3	1560	1.32
4	877	1.76
5	561	2.20

Luminous flux luminaire 2895 lm

4000K - CRI 90 On board dimmer

- 09.7315.40
- 09.7315.14
- All White
- 09.7315.40.78

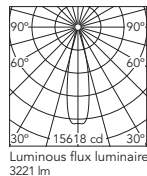

Beam Angle: 25°

h(m)	E(lx)	D(m)
1	15618	0.44
2	3904	0.88
3	1735	1.32
4	976	1.76
5	625	2.20

Luminous flux luminaire 3221 lm

3000K - CRI 80 On board dimmer

- 09.7316.40
- 09.7316.14
- All White
- 09.7316.40.78

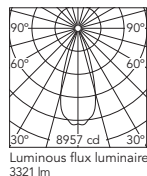

Beam Angle: 37°

h(m)	E(lx)	D(m)
1	8957	0.66
2	2239	1.32
3	995	1.98
4	560	2.65
5	358	3.31

Luminous flux luminaire 3321 lm

3000K - CRI 90 On board dimmer

- 09.7317.40
- 09.7317.14
- All White
- 09.7317.40.78

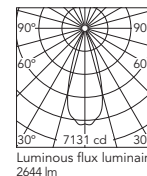

Beam Angle: 37°

h(m)	E(lx)	D(m)
1	7131	0.66
2	1783	1.32
3	792	1.98
4	446	2.65
5	285	3.31

Luminous flux luminaire 2644 lm

4000K - CRI 90 On board dimmer

- 09.7318.40
- 09.7318.14
- All White
- 09.7318.40.78

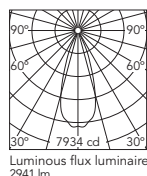

Beam Angle: 37°

h(m)	E(lx)	D(m)
1	7934	0.66
2	1983	1.32
3	882	1.98
4	496	2.65
5	317	3.31

Luminous flux luminaire 2941 lm

THE TRACKING POWER – LIGHT MODULES

UT Pro 175 Lens GA-69

Light Source: LED Array 35,3W - 3950 lm - 3000K/CRI 80 / 35,3W - 3250 lm - 3000K/CRI 90 / 35,3W - 3400 lm - 4000K/CRI 90

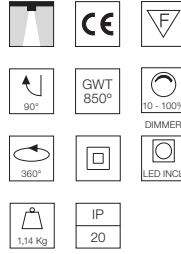
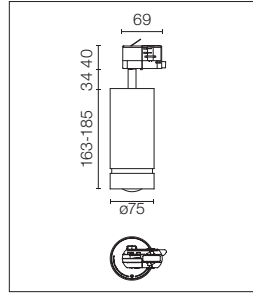

Scheinwerfer mit LED Lichtquelle zum Einbau in Standard-Dreiphasenschiene. Besitzt eine verstellbare Linse, mit der man den Öffnungswinkel von 13° bis 56° verändern kann. Netzgerät 120-270V inbegriffen.

Spotlight to be installed in standard 3-phase track with LED light source. Includes adjustable lens allowing opening angle calibration from 13° to 56°. 120-270V power supply integrated.

Bei den Versionen 40 sind der Schienenadapter, der Arm und der Hinterkopf schwarz. Bei den "All White" -Versionen sind der Schienenadapter, der Arm, der Hinterkopf und der Kopf weiß, nur der Blendschutzring bleibt schwarz.

.40 versions come with the track adapter, the arm and the rear of the head in black. In the "All white" versions, the track adapter, the arm, the rear of the head and the head are white. Only the anti-glare ring is black.

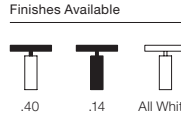

3000K - CRI 80 On board dimmer

- 09.7373.40
- 09.7373.14
- All White
- 09.7373.40.78

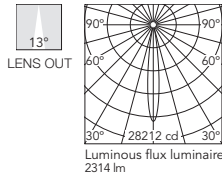

Beam Angle: 13°

h(m)	E(lx)	D(m)
1	28212	0.23
2	7053	0.46
3	3135	0.70
4	1763	0.93
5	1128	1.16

Luminous flux luminaire 2314 lm

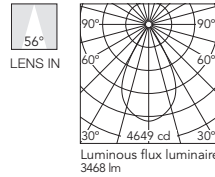

Beam Angle: 56°

h(m)	E(lx)	D(m)
1	4649	1.07
2	1162	2.14
3	517	3.21
4	291	4.29
5	186	5.36

Luminous flux luminaire 3468 lm

3000K - CRI 90 On board dimmer

- 09.7374.40
- 09.7374.14
- All White
- 09.7374.40.78

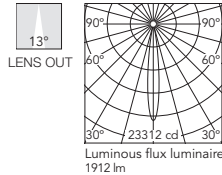

Beam Angle: 13°

h(m)	E(lx)	D(m)
1	23312	0.23
2	5828	0.46
3	2590	0.70
4	1457	0.93
5	932	1.16

Luminous flux luminaire 1912 lm

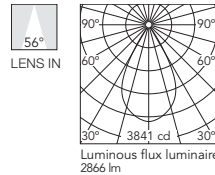

Beam Angle: 56°

h(m)	E(lx)	D(m)
1	3841	1.07
2	960	2.14
3	427	3.21
4	240	4.29
5	154	5.36

Luminous flux luminaire 2866 lm

4000K - CRI 90 On board dimmer

- 09.7375.40
- 09.7375.14
- All White
- 09.7375.40.78

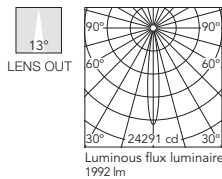

Beam Angle: 13°

h(m)	E(lx)	D(m)
1	24291	0.23
2	6073	0.46
3	2699	0.70
4	1518	0.93
5	972	1.16

Luminous flux luminaire 1992 lm

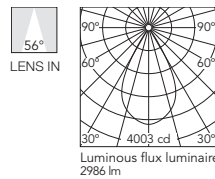

Beam Angle: 56°

h(m)	E(lx)	D(m)
1	4003	1.07
2	1001	2.14
3	445	3.21
4	250	4.29
5	160	5.36

Luminous flux luminaire 2986 lm

UT Pro Wall-Washer GA-69 (Dali GA-600)

Light Source: Top LED 25,5W - 2700 lm - 3000K/CRI 90 / 25,5W - 2900 lm - 4000K/CRI 90

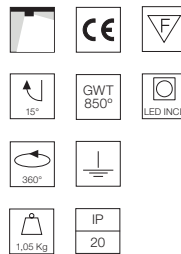
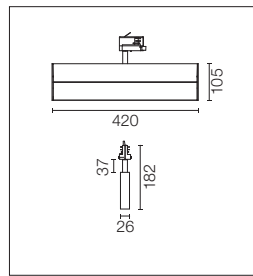

Lichtmodul Wall-Washer mit LED Lichtquelle zum Einbau in Standard-Dreiphasenschiene. Netzgerät 220-240V inbegriffen. Für die DALI-Version benötigen Sie dimmbare Schienen (siehe Kapitel "Tracks").

Wall-Washer lighting module to be installed in standard 3-phase track with LED light source. 220-240V power supply integrated. DALI version requires dimmable tracks (please refer to the "Tracks" chapter).

Bei den Versionen 40 sind der Schienenadapter, der Arm und der Hinterkopf schwarz. Bei den "All White" -Versionen sind der Schienenadapter, der Arm, der Hinterkopf und der Kopf weiß, nur der Blendschutzring bleibt schwarz.

.40 versions come with the track adapter, the arm and the rear of the head in black. In the "All white" versions, the track adapter, the arm, the rear of the head and the head are white. Only the anti-glare ring is black.



3000K - CRI 90 Non Dimmable

- 09.7504.40
- 09.7504.14
- All White
- 09.7504.40.78

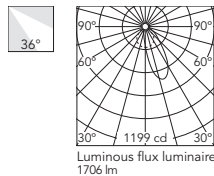

Beam Angle: 36°

h(m)	E(lx)	D(m)
1	1199	0.76
2	300	1.52
3	133	2.34
4	75	3.12
5	48	3.92

Luminous flux luminaire 1706 lm

4000K - CRI 90 Non Dimmable

- 09.7505.40
- 09.7505.14
- All White
- 09.7505.40.78

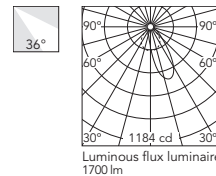

Beam Angle: 36°

h(m)	E(lx)	D(m)
1	1184	0.76
2	296	1.52
3	132	2.28
4	74	3.04
5	47	3.80

Luminous flux luminaire 1700 lm

Dali Version

- 09.7504.40.DA
- 09.7504.14.DA
- All White
- 09.7504.40.YU

Dali Version

- 09.7505.40.DA
- 09.7505.14.DA
- All White
- 09.7505.40.YU





THE TRACKING POWER

Zubehör / Accessories

UT Pro 150 / UT Pro 175

Querabschirmung, Linsen und Honeycomb können ohne Befestigungszubehör direkt in den Leuchtenkopf eingesetzt werden. Honeycomb + Linse können gleichzeitig verwendet werden.

Screening crosspiece, lenses and honeycomb directly installable on the head of the luminaire without needing any fastening accessory. Installation compatible with honeycomb + lense at the same time.

Querabschirmung.	Screening crosspiece.		UT Pro 150 08.8429.00 UT Pro 175 08.9108.00
Elliptische linse.	Elliptical lens.		UT Pro 150 08.8431.00 UT Pro 175 08.9109.00
Floodlinse.	Flood lens.		UT Pro 150 08.8432.00 UT Pro 175 08.9110.00
Honeycomb.	Honeycomb.		UT Pro 150 08.8428.00 UT Pro 175 08.9107.00
Konische Abschirmung.	Snoot shielding cone.		UT Pro 150 08.0526.00 08.0526.40 08.0526.BW UT Pro 175 08.9111.00

THE TRACKING POWER – INSTALLATION PROFILES

WALL-WASHER INSTALLATION

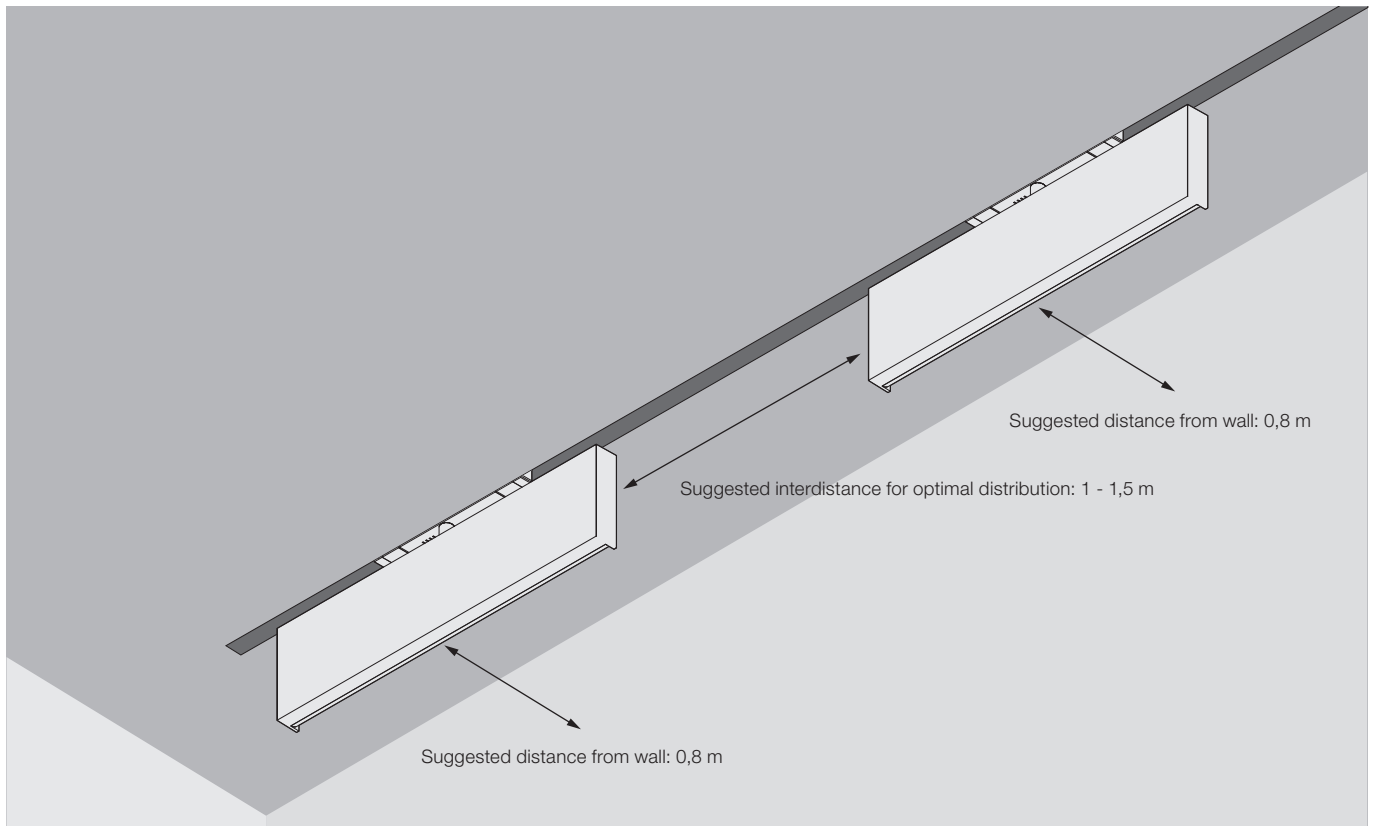



THE FAST TRACK
DESIGNED BY FLOS ARCHITECTURAL

RECESSED

SURFACE



Recessed Profiles  14 Schwarz
14 Black

Surface Profiles  40 Weiss
40 White  14 Schwarz
14 Black

LIGHT MODULES

THE FAST TRACK
SPOT 100



LIGHT SOURCE
POWER LED
13W
780 lm
3000K/CRI 90
830 lm
4000K/CRI 90

THE FAST TRACK
SPOT 150





LIGHT SOURCE
LED ARRAY
25,5W
1950 lm
3000K/CRI 90
2110 lm
4000K/CRI 90

MULTIFUNCTION
SMART DEVICE



FLOS CONTROL®
by Casambi

 14 Schwarz
14 Black

 BW Weiss
BW White



THE FAST TRACK

Produktbeschreibung

Das einzige System der Welt, mit dem Sie die Intensität der verschiedenen Gruppen von Beleuchtungskörpern mittels Fernsteuerung bewegen, ausrichten und einstellen können.

System für Innenräume in Versionen für die Oberflächenmontage oder den Deckeneinbau erhältlich.

Ausgestattet mit einer drahtlosen Steuerung mit dem FLOS Control® by Casambi-System, das über eine spezielle App für mobile Geräte verwaltet wird (mit einer Reichweite von etwa 20 m). Mit dem System können Sie bis zu 200 Geräte über die App steuern.

Die Beleuchtungsmodule enthalten Servomechanismen für die Bewegung und Ausrichtung, Sensoren zur Erkennung anderer Spots und das Ende der Schiene.

Das System ist in der Lage die Position jeden Spots zu jeder Zeit zu erkennen und bis zu 24 Lichtszenen einzuspeichern, indem die Lenkung, sowie Drehung und Lichtintensität für eine spätere Verwendung sowie, 4 Zeitprogramme, um von einer Szene zu einer anderen zu wechseln, gespeichert wird.

Sie können die Lichtszene auch vollständig ändern und die gespeicherten Kompositionen mit einem einfachen Klick wiederherstellen. Die Umstellung muss immer manuell und individuell über die APP erfolgen.

Strukturprofile des Systems aus stranggepresstem Aluminium in schwarz und weiß für die Version 40. Diese ist ausgestattet mit Stromschienen, die mit 48V gespeist werden und auf denen sie mittels eines mechanischen Befestigungssystems für die LED-Leuchten montiert werden.

Die Produktfamilie besteht aus Akzent-Beleuchtungsmodulen mit verschiedener Optik.

Das einzige verfügbare Steuerungssystem ist FLOS Control® by Casambi .

Es ist eine App für Mobilgeräte erforderlich (verfügbar im Apple Store und Google Play).

Die maximale Länge für ein Netzteil beträgt 20 m.

Die maximale Länge zwischen der Stromversorgung und dem Beginn der Schiene beträgt 2 m.

Optisches System

Die Akzent-Lichtsysteme sind mit Hochleistungsglasoptik und mit den Winkeln Superspot, Spot, Medium und Flood erhältlich.

Einspeisung

Fernstromquelle zu 48 V nicht eingeschlossen.

Zusatzinformationen

Schutzgrad IP20.

Auf normal entflammaren Oberflächen einsetzbar.

Qualitätszeichen

Das Gerät entspricht der europäischen technischen Norm EN60598-1 und den entsprechenden Zusatzregelungen.

Description

Only system in the world that allows the intensity of different groups of light fittings to be moved, oriented, and adjusted at a distance.

Indoor system available in versions for installation on surfaces and recessed installation on the ceiling. Equipped with wireless control via the FLOS Control® by Casambi system managed using the dedicated app for mobile devices (covers a distance of about 20 m). The system allows up to 200 devices to be controlled via the app.

The lighting modules incorporate servos for moving and orienting them, as well as sensors to detect other spots and the end of the track.

The system can recognize the location of each spot at all times and memorize up to 24 scenes of light. It memorizes the orientation, rotation and light intensity for later use, as well as 4 time schedules to change from one scene to another.

The light scene can also be completely changed by recovering the memorized compositions with a simple click. The movement must always be performed manually and individually through the APP.

Structural profiles of the system are manufactured in black extruded aluminum and are white plated for the 40 version, provided with electric tracks fed at 48V, on which the LED luminaires are installed by means of a mechanical fixing system.

The family is composed of accent lighting, with different optics.

The only available control system is FLOS Control® by Casambi.

The app for mobile devices is also necessary (available in the Apple Store and Google Play).

The maximum length for each power source is 20 m.

The maximum length between the power supply and the start of the track is 2 m.

Optic system

The accent light modules are available with high-performance crystal optics. Super spot, spot, medium and flood angles.

Power Supply

Remote 48V power source not included.

Additional Information

IP20 protection grade.

Suitable for installation on normally inflammable surfaces.

Compliance of Standards and Quality Marks

EN60598-1 European Technical Standards and any subsequent additions.

FLOS
CONTROL BY CASAMBI



HOW TO ORDER

1 CHOOSE YOUR PROFILE AND LENGTH

2 COMPLETE WITH MOUNTING ACCESSORIES

RECESSED PROFILE

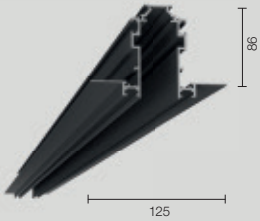

L: 1 / 1,5 / 2 / 3 m

Feed cable



End cap



Intermediate cable



Stopper



Electrical



Recessed installation

Accessories
(Optional)

Fixed ceiling kit



Adjustable ceiling kit



or

SURFACE PROFILE

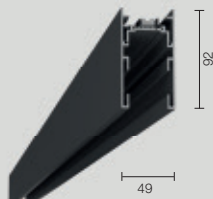

L: 1 / 1,5 / 2 / 3 m

Feed cable



End cap



Intermediate cable



Stopper



Electrical



Surface installation

Fixing ceiling kit included with the profile

THE FAST TRACK

3 SELECT POWER SUPPLY

Recessed installation

Remote power supply



185W



320W

(select the driver with the appropriate power according to the needs of your project)

Surface installation

Remote power supply



185W



320W

(select the driver with the appropriate power according to the needs of your project)

4 SELECT A LIGHT MODULE

Spot 100



Casambi integrated



SS/S/M

Spot 150



Casambi integrated



S/M/F

Multifunction Smart Device

FLOS Control® by Casambi



THE FAST TRACK – RECESSED PROFILES

Profile

Elektromechanisches Profil für den Einbau in Gipskartondecken mit Längen von 1 m bis 3 m. Strom- und Verbindungskabel müssen separat bestellt werden.
Die Abdeckungen sind getrennt zu bestellen.
Feste oder einstellbare Befestigungs-Kits sind verfügbar (Option). Die Kits für die Deckenbefestigung ermöglichen eine Installation ohne Erfordernis von TC-Aluminiumprofilen für die Befestigung.

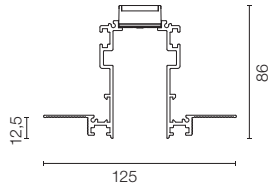
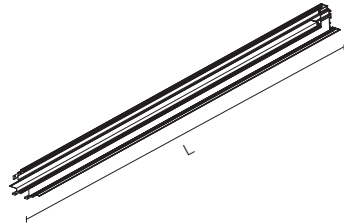

L: 1 m / 1,5 m / 2 m / 3 m

Profiles

Electro-mechanical profile for recessed installations in plasterboard ceilings, with 1m to 3m lengths. Power and interconnection cables must be ordered separately.
The covers must be ordered separately. Fixed or adjustable fastening kits available (optional). The roof fastening kits enable installation without the need for aluminium TC fastening profiles.

- L: 1000 mm 06.1850.14
- L: 1500mm 06.1851.14
- L: 2000 mm 06.1852.14
- L: 3000 mm 06.1853.14

Befestigungssatz feste decke (fakultativ). Set mit 2 stück.

Fixed ceiling kit (optional). 2 unit kit.

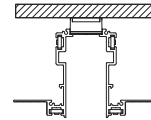

■ 08.8866.14

Befestigungssatz an absenkbare decke (fakultativ). Set mit 2 stück. Für die Installation ist eine M6-Gewindestange erforderlich, die nicht im Lieferumfang enthalten ist.

Adjustable ceiling kit (optional). 2 unit kit. Installation requires a M6 threaded rod, not included.

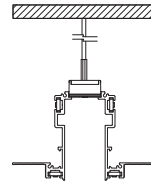

■ 08.8867.14

Profile (mm)	Quantities Ceiling Kit
1000	1
2000	2
3000	2
4000	3

1 m lange Aufhängestange mit Rosette mit Mo-Verschraubung.

1-m suspension rod with ceiling rose with m6 thread.



□ 60.3097.11
■ 60.3097.14

Endkappe. Muss separat bestellt werden. Set mit 2 stück.

End caps. To be ordered separately. 2 unit kit.



■ 08.9070.14

THE FAST TRACK – SURFACE PROFILES

Profile

Elektromechanisches Profil für die Oberflächenmontage in Gipskartondecken mit Längen von 1 m bis 3 m. Nicht gültig für hängende Installationen. Strom- und Verbindungskabel müssen separat bestellt werden. Die Deckel müssen separat bestellt werden. Inklusive Befestigungskit für feste Decke.

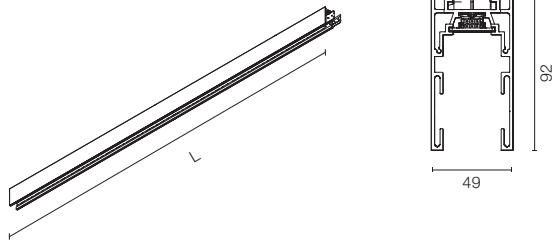

L: 1 m / 1,5 m / 2 m / 3 m

Profiles

Electro-mechanical profile for surface installations in plasterboard ceilings, with 1m to 3m lengths. Not suitable for suspended installations. Power and interconnection cables must be ordered separately. Covers must be ordered separately. Fixed ceiling kit included.

- L: 1000 mm
 - 06.1860.40
 - 06.1860.14
- L: 1500 mm
 - 06.1861.40
 - 06.1861.14
- L: 2000 mm
 - 06.1862.40
 - 06.1862.14
- L: 3000 mm
 - 06.1863.40
 - 06.1863.14

Endkappe. Diese müssen separat bestellt werden. Set mit 2 Stück.

End caps. Must be ordered separately. 2 unit kit.



- 08.9071.40
- 08.9071.14

The Fast Track Recessed / Surface versions

Stopper. Um zu verhindern, dass die Spots in Spuren eindringen, die von einem anderen Treiber betrieben werden, und um zu vermeiden, dass die maximal zulässige Leistung jedes Treibers überschritten wird. Es kann auch verwendet werden, um die Bewegung aus anderen Gründen zu begrenzen.

Stopper. To prevent spots from invading track areas powered by another driver and to prevent exceeding the maximum allowed power of each driver. It can also be used to limit movement for other reasons.



- 08.9074.14

Einspeisekabel.

Power feed cable.



06.0303.00

Verbindungskabel. Elektrischer Anschluss.

Connection cable. Electrical connection.



06.0301.00

THE FAST TRACK – INSTALLATION PROFILES

RECESSED INSTALLATION

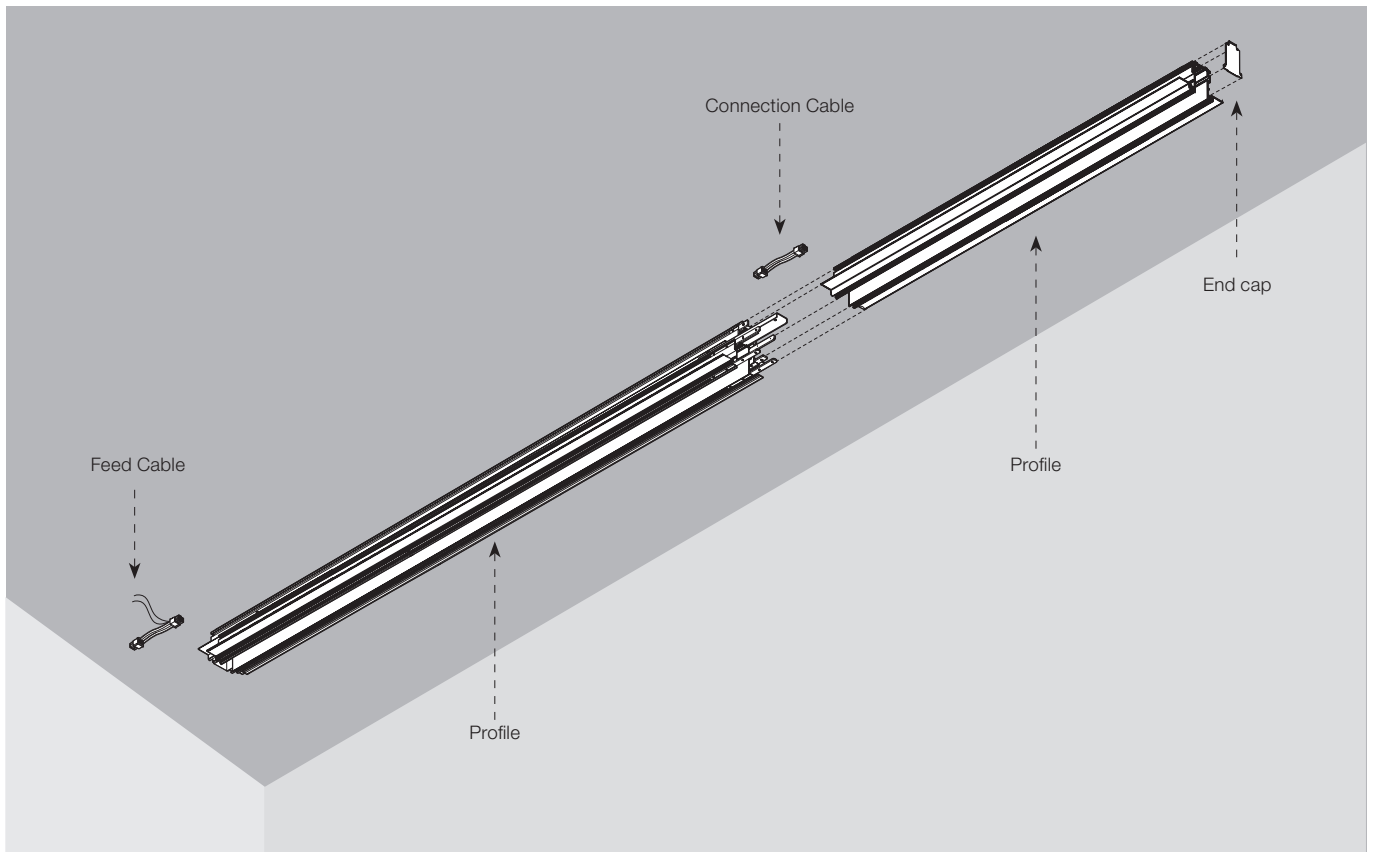

SURFACE INSTALLATION

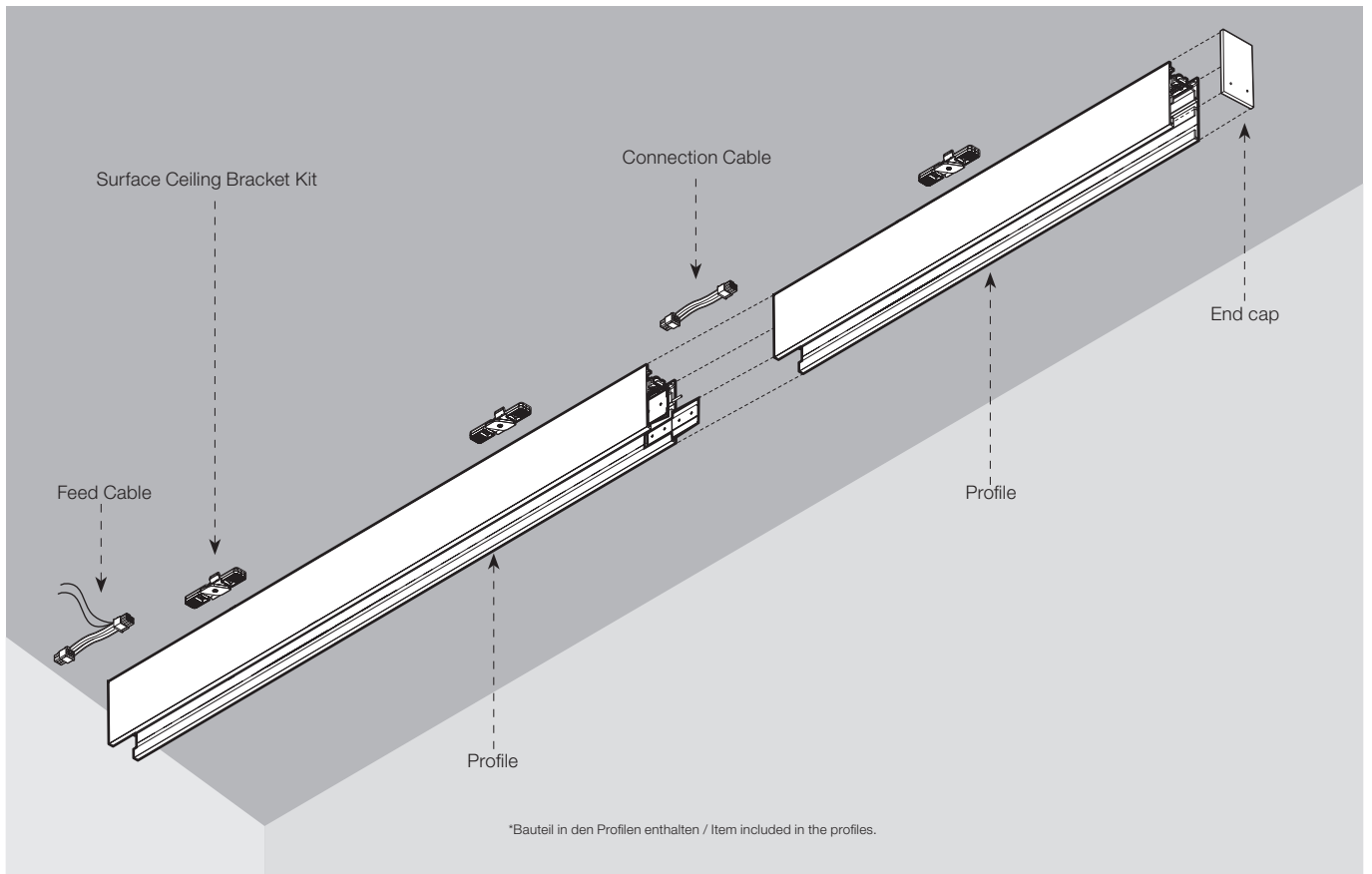

THE FAST TRACK – LIGHT MODULES

The Fast Track Spot 100

Light Source: Power LED 13W - 830 lm - 3000K/CRI 90 / 13W - 878 lm - 4000K/CRI 90

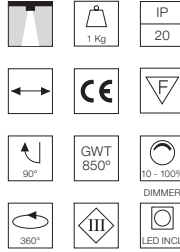
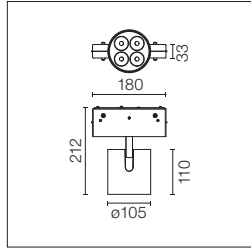

Projektor zur Installation im Profil des The Fast Track-Systems mit LED-Lichtquelle und Superspot-Optik, sehr nützlich für große Höhen, sowie Medium- und Flood-Optik.
Die Kästen der Leuchten werden nur in Schwarz angefertigt.

Spotlight to be installed in the The Fast Track system profile with a LED light source and super spot optic, very useful for great heights, medium and flood.
The boxes of the luminaries are manufactured only in black.

3000K

**Casambi integrated

09.9070.BW
09.9070.14

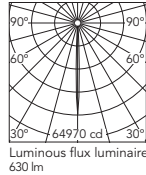

Beam Angle: 4°		
h(m)	E(lx)	D(m)
1	64970	0.07
2	16243	0.14
3	7219	0.21
4	4061	0.28
5	2599	0.35

4000K

**Casambi integrated

09.9075.BW
09.9075.14

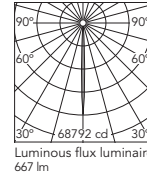

Beam Angle: 4°		
h(m)	E(lx)	D(m)
1	68792	0.07
2	17198	0.14
3	7644	0.21
4	4300	0.28
5	2752	0.35

3000K

**Casambi integrated

09.9071.BW
09.9071.14

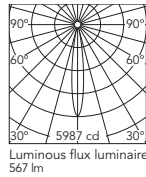

Beam Angle: 15°		
h(m)	E(lx)	D(m)
1	5987	0.26
2	1497	0.52
3	665	0.77
4	374	1.03
5	239	1.29

4000K

**Casambi integrated

09.9076.BW
09.9076.14

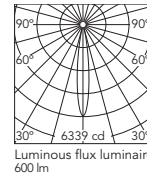

Beam Angle: 15°		
h(m)	E(lx)	D(m)
1	6339	0.26
2	1585	0.52
3	704	0.77
4	396	1.03
5	254	1.29

3000K

**Casambi integrated

09.9072.BW
09.9072.14

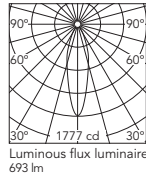

Beam Angle: 27°		
h(m)	E(lx)	D(m)
1	1777	0.48
2	444	0.95
3	197	1.43
4	111	1.91
5	71	2.38

4000K

**Casambi integrated

09.9077.BW
09.9077.14

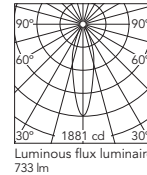

Beam Angle: 27°		
h(m)	E(lx)	D(m)
1	1881	0.48
2	470	0.95
3	209	1.43
4	118	1.91
5	75	2.38

** Die Steuerung bei den Casambi-Leuchten erfolgt direkt und individuell kabellos mittels der App FLOS Control® powered by Casambi / The control system with the Casambi version of light fixtures is directly and individually regulated wirelessly using the application FLOS Control® by Casambi.

THE FAST TRACK – LIGHT MODULES

The Fast Track Spot 150

Light Source: LED Array 25,5W - 2080 lm - 3000K/CRI 90 / 25,5W - 2262 lm - 4000K/CRI 90

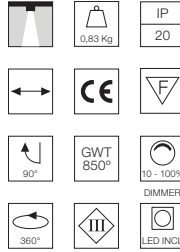
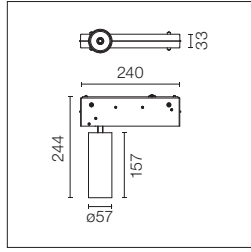

Projektor zur Installation im Profil des The Fast Track-Systems mit LED-Lichtquelle und Glasoptik: Spot, Medium und Flood mit hoher Leistungsfähigkeit. Die Kästen der Leuchten werden nur in Schwarz angefertigt.

Spotlight to be installed in the The Fast Track system profile with a LED light source and glass optics: high performance spot, medium and flood lights. The boxes of the luminaries are manufactured only in black.

3000K

**Casambi integrated

09.9083.BW
09.9083.14

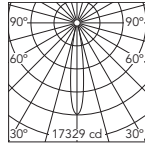

Beam Angle: 16°		
h(m)	Ef(x)	D(m)
1	17329	0.28
2	4332	0.56
3	1925	0.84
4	1083	1.12
5	693	1.40

Luminous flux luminaire 1872 lm

4000K

**Casambi integrated

09.9086.BW
09.9086.14

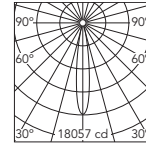

Beam Angle: 16°		
h(m)	Ef(x)	D(m)
1	18057	0.28
2	4514	0.56
3	2006	0.84
4	1129	1.12
5	722	1.40

Luminous flux luminaire 1951 lm

3000K

**Casambi integrated

09.9084.BW
09.9084.14

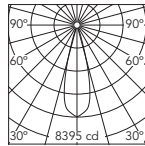

Beam Angle: 28°		
h(m)	Ef(x)	D(m)
1	8395	0.50
2	2099	1.00
3	933	1.50
4	525	2.00
5	336	2.50

Luminous flux luminaire 1816 lm

4000K

**Casambi integrated

09.9087.BW
09.9087.14

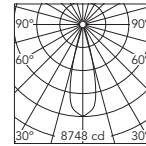

Beam Angle: 28°		
h(m)	Ef(x)	D(m)
1	8748	0.50
2	2187	1.00
3	972	1.50
4	547	2.00
5	350	2.50

Luminous flux luminaire 1892 lm

3000K

**Casambi integrated

09.9085.BW
09.9085.14

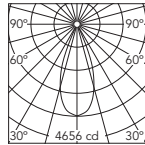

Beam Angle: 40°		
h(m)	Ef(x)	D(m)
1	4656	0.73
2	1164	1.46
3	517	2.18
4	291	2.91
5	186	3.64

Luminous flux luminaire 1838 lm

4000K

**Casambi integrated

09.9088.BW
09.9088.14

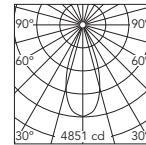

Beam Angle: 40°		
h(m)	Ef(x)	D(m)
1	4851	0.73
2	1213	1.46
3	539	2.18
4	303	2.91
5	194	3.64





Luminous flux luminaire 1915 lm

Zubehör / Accessories

The Fast Track Spot 150

Querabschirmung, Linsen und Honeycomb können ohne Befestigungszubehör direkt in den Leuchtenkopf eingesetzt werden. Honeycomb + Linse können gleichzeitig verwendet werden.

Screening crosspiece, lenses and honeycomb directly installable on the head of the luminaire without needing any fastening accessory. Installation compatible with honeycomb + lense at the same time.

Querabschirmung.	Screening crosspiece.		08.8429.00
Elliptische linse.	Elliptical lens.		08.8431.00
Floodlinse.	Flood lens.		08.8432.00
Honeycomb.	Honeycomb.		08.8428.00
Konische abschirmung.	Snoot shielding cone.		08.0526.00 08.0526.40 08.0526.BW

** Die Steuerung bei den Casambi-Leuchten erfolgt direkt und individuell kabellos mittels der App FLOS Control® powered by Casambi / The control system with the Casambi version of light fixtures is directly and individually regulated wirelessly using the application FLOS Control® by Casambi.

Treiber / Drivers

LED-Netzteil für Ferninstallation
48V/320W. 100/240 Vac.

LED power supply source for
remote installation, 48V/320W.
100/240 Vac.

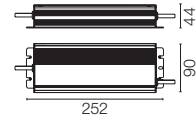

*60.8919

LED-Netzteil für Ferninstallation
110Vac-135W / 220Vac-200W.

LED power supply source for
remote installation,
110Vac-135W / 220Vac-200W.

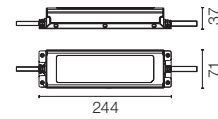

*60.9607

LED-Netzteil für Ferninstallation
48V/120W. 220/240 Vac.

LED power supply source for
remote installation, 48V/120W.
220/240 Vac.



*60.9170

Multifunktionales Smart Device.
Dreifachfunktionalität 3x1: Casambi
Signalverstärker, Lichtsensor und
Präsenzmelder.
FLOS Control® by Casambi.

Multifunction Smart Device.
Triple functionality 3x1: Casambi
signal repeater, light sensor and
presence detector.
FLOS Control® by Casambi.

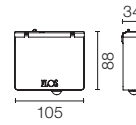

06.1987.40
06.1987.14

* Bei der Dimensionierung der Anlage ist eine Sicherheitsspanne von 15 % der maximalen Leistung der LED-Stromversorgung einzuhalten / For the sizing of the installation keep a safety margin of 15% of the maximum power of the LED power source.

IN-FINITY

DESIGNED BY FLOS ARCHITECTURAL

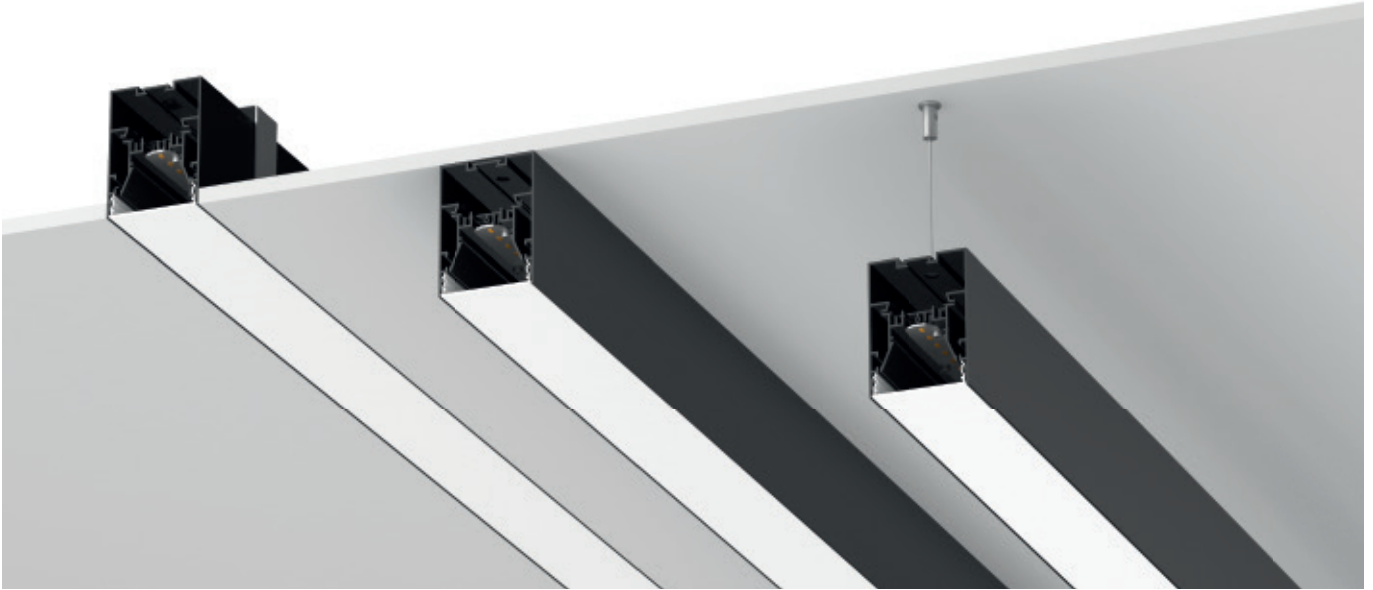

RECESSED TRIM / NO TRIM	SURFACE	SUSPENSION DOWN	SUSPENSION UP&DOWN		
35 mm	70 mm	100 mm	35 mm	70 mm	100 mm
LIGHT SOURCE TOP LED 18,5W/m 2665 lm/m 3000K/CRI 80 18,5W/m 2800 lm/m 4000K/CRI 80	LIGHT SOURCE TOP LED 25W/m 2985 lm/m 3000K/CRI 80 25W/m 3135 lm/m 4000K/CRI 80	LIGHT SOURCE TOP LED 25,5W/m 3110 lm/m 3000K/CRI 80 25,5W/m 3265 lm/m 4000K/CRI 80	LIGHT SOURCE TOP LED 31,5W/m 1785 lm/m UP 2665 lm/m DOWN 3000K/CRI 80 31,5W/m 1875 lm/m UP 2800 lm/m DOWN 4000K/CRI 80	LIGHT SOURCE TOP LED 38W/m 1785 lm/m UP 2985 lm/m DOWN 3000K/CRI 80 38W/m 1875 lm/m UP 3135 lm/m DOWN 4000K/CRI 80	LIGHT SOURCE TOP LED 38,5W/m 1785 lm/m UP 3110 lm/m DOWN 3000K/CRI 80 38,5W/m 1875 lm/m UP 3265 lm/m DOWN 4000K/CRI 80

□ 30 Weiss
30 White

■ 02 Grau-eloxiert
02 Anodized Grey

■ 14 Schwarz
14 Black



Produktbeschreibung

LED-Beleuchtungssystem für die Unterputz-, Aufputz oder abgehängte Montage, für Arbeitsbereiche und professionelles Ambiente. Die Leuchten sind in 3 verschiedenen Durchmessern erhältlich 35 mm, 70 mm oder 100 mm.

Das System besteht aus geraden Elementen in Größen zwischen 565 mm und 3095 mm, Eckelementen für Winkeln auf derselben Oberfläche oder mit Oberflächenwechsel z. B. Decke-Wand und Zubehörteilen, wie Verschlüsse und Aufhängeset.

Folgende Teile sind bei allen Ausführungen im Lieferumfang der Leuchten enthalten:

- LED-Beleuchtungsmodule samt Treiber in den Ausführungen 3000K und 4000K.
- Aluminiumprofil für die Installation.
- Reflektor.
- Verbindungssystem für den Anschluss der Module.
- Fallschutzseil für die Leuchten, um maximalen Schutz während der Installationsarbeiten zu gewährleisten.

Es stehen zwei verschiedene Diffusoren zur Wahl: opal für die allgemeine Beleuchtung und ein mikroprismatischer Diffusor für besseren Sehkomfort. Auch als separates Zubehör zum Füllen von Lücken in Bauwerken mit Ecken oder länger als 3 m erhältlich.

Das Außenprofil der Unterputzausführung No Trim ist nur in Weiss erhältlich. Alle anderen Ausführungen sind in Weiß, Grau-eloxiert und Schwarz erhältlich.

Einspeisung

Treiber in den Beleuchtungsmodulen für Direktanschluss an das 220-240V Stromnetz oder an andere Module des Systems inbegriffen.

Zubehör

- Endkappe. Ist getrennt zu bestellen.
- Aufhängeset.
- Einspeisungsset.

Zusatzinformationen

In DALI 1-100% Ausführung erhältlich.
Dimmbare 1-10 V-Ausführung auf Anfrage.
Schutzgrad IP20, IP40.
Schutzklasse I.

Qualitätszeichen

Das Gerät entspricht der europäischen technischen Norm EN60598-1 und den entsprechenden Zusatzregelungen.

Description

LED lighting system for recessed, surface or suspended installation, designed for work areas and the illumination of professional spaces. Luminaires are available in three different sections of 35 mm, 70 mm or 100 mm.

The system is composed of straight elements, with a range of measurements, from 565 up to 3095 mm, corner elements for angles on the same surface, or with wall-ceiling surface change, accessories such as end covers, and a suspension kit.

In all versions the luminaires come with:

- LED lighting modules, including drivers, in 3000K or 4000K versions.
- Aluminum installation channel.
- Reflector.
- Junction system for the connection of the system's modular element.
- Safety cable to protect against the lamp's accidental falling, to provide for maximum safety during installation.

Two different diffusers are available: opal, for general, diffuse lighting; or a micro-prismatic for a for better visual comfort. Also available as separate accessories to fill gaps in structures with corners or longer than 3 meters.

The external profile of the Recessed No Trim version is only available in white finish. All other versions are available in these finishes: white, anodized grey and black.

Power Supply

Drivers included in lighting modules for 220-240V connections to mains or to other lighting modules.

Accessories

- End caps. Must be ordered separately.
- Suspension kit.
- Feed unit kit.

Additional Information

Also available in DALI 1-100% version.
Dimmable 1-10V version under request.
IP20, IP40 protection degree.
Insulation Class I.

Standard Compliance and Quality Marks

EN60598-1 European Technical Standards and any subsequent additions.



Recessed
No Trim



Recessed
Trim



Surface



Suspension
Down



Suspension
Up&Down

IN - FINITY

Profile

Beleuchtungselemente mit geradem und eckigen Profilen in verschiedenen Längen, die entsprechend den Oberflächen jedes Projekts miteinander verbunden oder mit den Verschlüssen an jedem Ende als Einzeleuchten verwendet werden können.
Alle Elemente des Systems werden zur Gänze durch integrierte LED-Module beleuchtet. Ebenfalls im Lieferumfang enthalten sind der zur gewählten Ausführung passende Treiber, der Installationskanal und der Reflektor. Individuell angepasste X- oder T-Elemente auf Anfrage erhältlich.

Profiles

Straight elements of different lengths and corner elements, to be composed according to the specific need of each project or to be completed by a pair of end caps and used as a single lamp.
All system elements are completely illuminated by an included LED module, the required driver, installation channel, and the diffuser for the version selected. Custom X or T elements available under request.

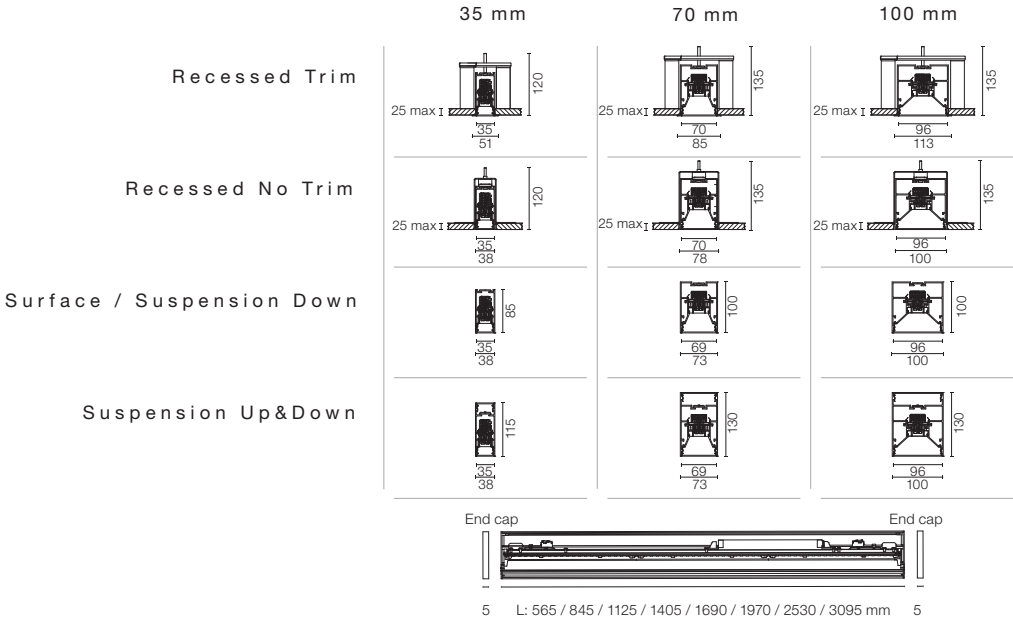

Einfächlige Ecke / Flat Corner

Eckleuchte für Winkeln auf derselben Oberfläche, samt zur gewählten Ausführung passendem Treiber, Installationskanal und Reflektor.

Corner element lamps for angles on the same surface, complete with a driver, installation channel and the diffuser for the version selected.

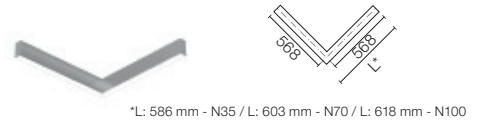

Zweiflächige Ecke / Dihedral Corner

Eckleuchte für Ecken mit Oberflächenwechsel (beispielsweise Decke zu Wand) samt zur gewählten Ausführung passendem Treiber, Installationskanal und Reflektor. Für die Version Abhängung nicht verfügbar.

Corner element lamps for angles with surface changes (example: angle ceiling / wall), complete with a driver, installation channel and the diffuser for the version selected. For suspended versions not available.

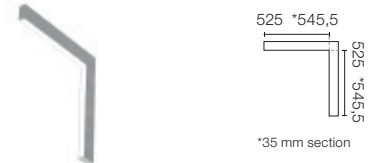

Notfall / Emergency

Notfallmodul in allen Versionen verfügbar, mit Ausnahme der Up&Down-Version. Bei Normaleinsatz entspricht der Verbrauch dem der Standardanlage In-Finity. Im Notlichteinsatz gibt sie für eine Dauer von 3 Stunden 10 % des normalen Lichtsflusses ab.

Emergency module available for all versions except for the Up&Down version. In normal use, it uses the same power consumption as the standard In-Finity. In emergency use, it emits 10% of normal use during 3 hours.

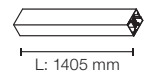

*Opaler Diffusor / Opal Diffuser

Diffuse, gleichmäßige und blendfreie Raumbelichtung. Auch als separates Zubehör zum Füllen von Lücken in Bauwerken mit Ecken oder länger als 3 m erhältlich.

Diffuse, glare free and uniform lighting throughout the room. Also available as separate accessory to fill gaps in structures with corners or longer than 3 meters.



*Mikroprismatischer Diffusor / Micro-Prismatic Diffuser

Hochwirksamer Diffusor, der durch seine einzigartige, mehrlagige mikro-prismatische Struktur für eine blendfreie Beleuchtung im UGR<19 Winkel sorgt. Auch als separates Zubehör zum Füllen von Lücken in Bauwerken mit Ecken oder länger als 3 m erhältlich.

Highly efficient multilayer diffuser that, thanks to its unique micro-prismatic texture, provides a glare free UGR<19 light beam. Also available as separate accessory to fill gaps in structures with corners or longer than 3 meters.



IN-FINITY

WIE SIE ZU IHREM CODE KOMMEN / HOW TO GET YOUR CODE

Für einen schnelleren Einblick und eine Gesamtübersicht über das Sortiment wurde die Nummerierungs-Struktur der Teile der Leuchtenfamilie In-Finity so aufgebaut, dass sie nach ihrer Zusammensetzung den spezifischen Anforderungen jeder Installation entspricht. Sie müssen nur aus der nachstehenden Tabelle für jedes Feld die Zahl oder den Buchstaben auswählen, die/der Ihrer benötigten In-Finity Version entspricht, daraus ergibt sich der Endcode.

For a quicker understanding and easier overview of the range, the part number structure for the In-Finity family has been created to be composed to match the requests of each specific installation. According to the following table, for each field, just choose the number or letter corresponding to the In-Finity version you need, and you'll have the final code.

Sektion / Section		N	70	S	25	4	U	14B	DA	
35 mm	35	}	}	}	}	}	}	}	}	
70 mm	70									
100 mm	10									
*Installation / Installation		}	}	}	}	}	}	}	}	
Recessed Trim	T									
Recessed No Trim	N									
Surface	S									
Suspension Down	D									
Suspension Up&Down	U									
Elemente / Elements		}	}	}	}	}	}	}	}	
Geradlinig / Straight 565 mm	05									
Geradlinig / Straight 845 mm	08									
Geradlinig / Straight 1125 mm	11									
Geradlinig / Straight 1405 mm	14									
Geradlinig / Straight 1690 mm	16									
Geradlinig / Straight 1970 mm	19									
Geradlinig / Straight 2530 mm	25									
Geradlinig / Straight 3095 mm	30									
Einflächige Ecke / Flat Corner	FC									
Zweiflächige Ecke / Dihedral Corner	DC									
Notfall / Emergency (1405 mm)	EM									
Farbtemperatur / Color T^a (°K)		}	}	}	}	}	}	}	}	
3000K	3									
4000K	4									
**Optik / Optic		}	}	}	}	}	}	}	}	
General Lighting (Opal)	G									
Micro-Prismatic Diffuser	U									
Ausführungen / Colours		}	}	}	}	}	}	}	}	
Weiss / White	35 - 70 - 100 30B									30
Grau-eloxiert / Anodized Grey	02B									02
Schwarz / Black	14B	14								
Version / Version		}	}	}	}	}	}	}	}	
Standard (Non Dimmable)	35 - 70 - 100									
Dali	DA									

* Die Ausführung Recessed No Trim ist nur in Weiss (30) erhältlich. / No Trim Recessed version is only available in white finish (30).

Die Suspension Versionen sind nur mit Flachwinkel erhältlich. / In Suspension versions only available flat corner.

Das gerade Profil mit 565 mm für das Modell Suspension Up&Down ist nicht verfügbar. / Suspension Up&Down version is not available in 565 mm linear profile.

**Auch als separates Zubehör zum Füllen von Lücken in Bauwerken mit Ecken oder länger als 3 m erhältlich / Also available as separate accessories to fill gaps in structures with corners or longer than 3 m.

IN - FINITY

In-Finity Surface 35 mm

Light Source: Top LED 18,5W/m - 2665 lm/m - 3000K/CRI 80 / 18,5W/m - 2800 lm/m - 4000K/CRI 80

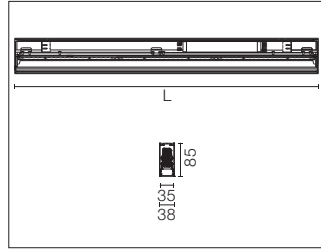

LED-Beleuchtungssystem in Modulbauweise für Aufputzmontage, bestehend aus LED-Modulen, Aluminiumprofil und Diffusor. Die Treiber für direkten Netzanschluss 220-240V oder für den Anschluss an andere Module des Systems sind in den Leuchtmodulen inbegriffen.

LED modular system for surface installation, including LED luminaires, aluminum installation profile, and diffusers. Drivers included in lighting modules for 220-240V connection to mains or to other lighting modules.

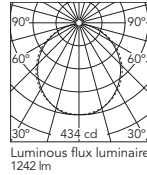

Beam Angle: 110°

h(m)	E(lx)	D(m)
1	434	2.84
2	108	5.68
3	48	8.52
4	27	11.36
5	17	14.19

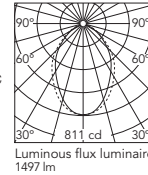

Beam Angle: 76°

h(m)	E(lx)	D(m)
1	811	1.55
2	203	3.11
3	90	4.66
4	51	6.22
5	32	7.77

In-Finity Surface 70 mm

Light Source: Top LED 25W/m - 2985 lm/m - 3000K/CRI 80 / 25W/m - 3135 lm/m - 4000K/CRI 80

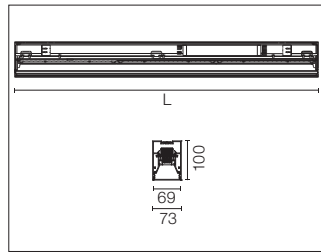

LED-Beleuchtungssystem in Modulbauweise für Aufputzmontage, bestehend aus LED-Modulen, Aluminiumprofil und Diffusor. Die Treiber für direkten Netzanschluss 220-240V oder für den Anschluss an andere Module des Systems sind in den Leuchtmodulen inbegriffen.

LED modular system for surface installation, including LED luminaires, aluminum installation profile, and diffusers. Drivers included in lighting modules for 220-240V connection to mains or to other lighting modules.

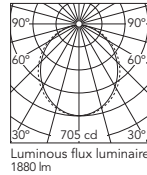

Beam Angle: 103°

h(m)	E(lx)	D(m)
1	705	2.51
2	176	5.03
3	78	7.54
4	44	10.05
5	28	12.57

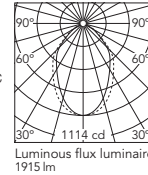

Beam Angle: 72°

h(m)	E(lx)	D(m)
1	1114	1.46
2	278	2.92
3	124	4.38
4	70	5.84
5	45	7.30

In-Finity Surface 100 mm

Light Source: Top LED 25,5W/m - 3110 lm/m - 3000K/CRI 80 / 25,5W/m - 3265 lm/m - 4000K/CRI 80

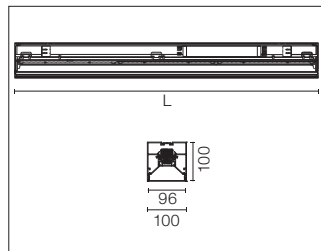
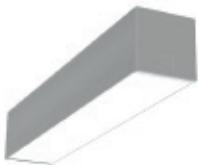

LED-Beleuchtungssystem in Modulbauweise für Aufputzmontage, bestehend aus LED-Modulen, Aluminiumprofil und Diffusor. Die Treiber für direkten Netzanschluss 220-240V oder für den Anschluss an andere Module des Systems sind in den Leuchtmodulen inbegriffen.

LED modular system for surface installation, including LED luminaires, aluminum installation profile, and diffusers. Drivers included in lighting modules for 220-240V connection to mains or to other lighting modules.

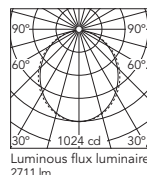

Beam Angle: 103°

h(m)	E(lx)	D(m)
1	1024	2.54
2	256	5.07
3	114	7.61
4	64	10.14
5	41	12.68

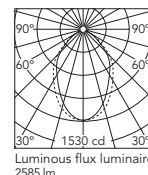

Beam Angle: 73°

h(m)	E(lx)	D(m)
1	1530	1.47
2	383	2.95
3	170	4.42
4	96	5.90
5	61	7.37

IN - FINITY

In-Finity Recessed Trim 35 mm

Light Source: Top LED 18,5W/m - 2665 lm/m - 3000K/CRI 80 / 18,5W/m - 2800 lm/m - 4000K/CRI 80

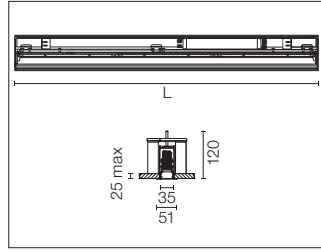

LED-Beleuchtungssystem in Modulbauweise für Unterputzmontage Trim/No trim, bestehend aus LED-Modulen, Aluminiumprofil und Diffusor. Die Treiber für direkten Netzanschluss 220-240V oder für den Anschluss an andere Module des Systems sind in den Leuchtmodulen inbegriffen.

LED modular system for recessed trim/no trim installation, including LED luminaires, aluminum installation profile and diffusers. Drivers included in lighting modules for 220-240V connection to mains or to other lighting modules.

In-Finity Recessed No Trim 35 mm

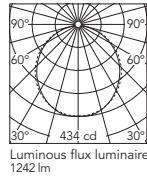
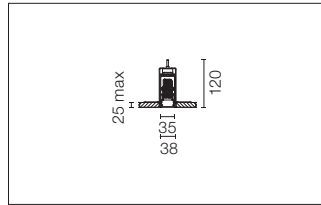

Beam Angle: 110°

h(m)	E(lx)	D(m)
1	434	2.84
2	108	5.68
3	48	8.52
4	27	11.36
5	17	14.19

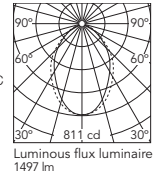

Beam Angle: 76°

h(m)	E(lx)	D(m)
1	811	1.55
2	203	3.11
3	90	4.66
4	51	6.22
5	32	7.77

In-Finity Recessed Trim 70 mm

Light Source: Top LED 25W/m - 2985 lm/m - 3000K/CRI 80 / 25W/m - 3135 lm/m - 4000K/CRI 80

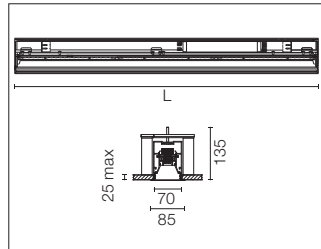

LED-Beleuchtungssystem in Modulbauweise für Unterputzmontage Trim/No trim, bestehend aus LED-Modulen, Aluminiumprofil und Diffusor. Die Treiber für direkten Netzanschluss 220-240V oder für den Anschluss an andere Module des Systems sind in den Leuchtmodulen inbegriffen.

LED modular system for recessed trim/no trim installation, including LED luminaires, aluminum installation profile and diffusers. Drivers included in lighting modules for 220-240V connection to mains or to other lighting modules.

In-Finity Recessed No Trim 70 mm

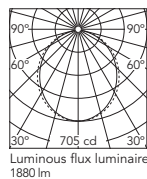
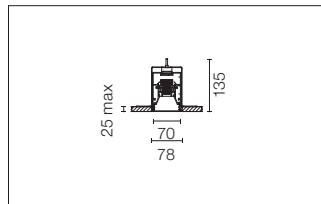

Beam Angle: 103°

h(m)	E(lx)	D(m)
1	705	2.51
2	176	5.03
3	78	7.54
4	44	10.05
5	28	12.57

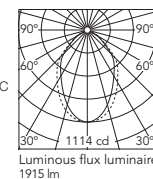

Beam Angle: 72°

h(m)	E(lx)	D(m)
1	1114	1.46
2	278	2.92
3	124	4.38
4	70	5.84
5	45	7.30

IN - FINITY

In-Finity Recessed Trim 100 mm

Light Source: Top LED 25,5W/m - 3110 lm/m - 3000K/CRI 80 / 25,5W/m - 3265 lm/m - 4000K/CRI 80

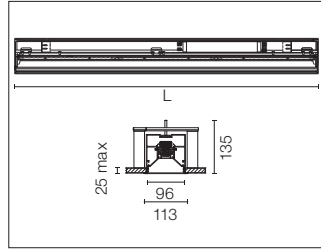
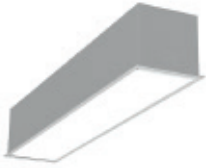

LED-Beleuchtungssystem in Modulbauweise für Unterputzmontage Trim/No trim, bestehend aus LED-Modulen, Aluminiumprofil und Diffusor. Die Treiber für direkten Netzanschluss 220-240V oder für den Anschluss an andere Module des Systems sind in den Leuchtmodulen inbegriffen.

LED modular system for recessed trim/no trim installation, including LED luminaires, aluminum installation profile and diffusers. Drivers included in lighting modules for 220-240V connection to mains or to other lighting modules.

In-Finity Recessed No Trim 100 mm

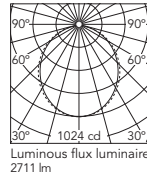
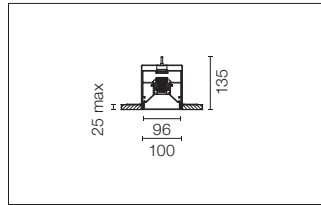

Beam Angle: 103°

h(m)	E(lx)	D(m)
1	1024	2.54
2	256	5.07
3	114	7.61
4	64	10.14
5	41	12.68

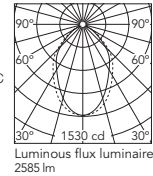

Beam Angle: 73°

h(m)	E(lx)	D(m)
1	1530	1.47
2	383	2.95
3	170	4.42
4	96	5.90
5	61	7.37

In-Finity Suspension Down 35 mm

Light Source: Top LED 18,5W/m - 2665 lm/m - 3000K/CRI 80 / 18,5W/m - 2800 lm/m - 4000K/CRI 80

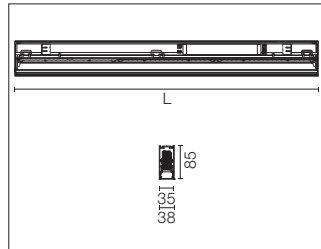

LED-Beleuchtungssystem in Modulbauweise für abgehängte Montage bestehend aus LED-Modulen, Aluminiumprofil und Diffusor. Die Treiber für direkten Netzanschluss 220-240V oder für den Anschluss an andere Module des Systems sind in den Leuchtmodulen inbegriffen. Befestigungsset nicht enthalten.

LED modular system for suspended installation, including LED luminaires, aluminum installation profile, and diffusers. Drivers included in lighting modules for 220-240V connection to mains or to other lighting modules. Suspension kit not included.

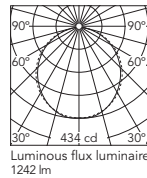

Beam Angle: 110°

h(m)	E(lx)	D(m)
1	434	2.84
2	108	5.68
3	48	8.52
4	27	11.36
5	17	14.19

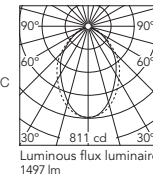

Beam Angle: 76°

h(m)	E(lx)	D(m)
1	811	1.55
2	203	3.11
3	90	4.66
4	51	6.22
5	32	7.77

IN - FINITY

In-Finity Suspension Down 70 mm

Light Source: Top LED 25W/m - 2985 lm/m - 3000K/CRI 80 / 25W/m - 3135 lm/m - 4000K/CRI 80

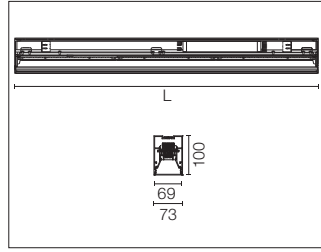

LED-Beleuchtungssystem in Modulbauweise für abgehängte Montage bestehend aus LED-Modulen, Aluminiumprofil und Diffusor. Die Treiber für direkten Netzanschluss 220-240V oder für den Anschluss an andere Module des Systems sind in den Leuchtmodulen inbegriffen. Befestigungsset nicht enthalten.

LED modular system for suspended installation, including LED luminaires, aluminum installation profile, and diffusers. Drivers included in lighting modules for 220-240V connection to mains or to other lighting modules. Suspension kit not included.

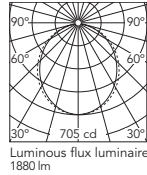

Beam Angle: 103°

h(m)	E(lx)	D(m)
1	705	2.51
2	176	5.03
3	78	7.54
4	44	10.05
5	28	12.57

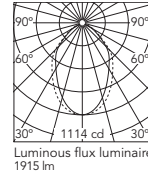

Beam Angle: 72°

h(m)	E(lx)	D(m)
1	1114	1.46
2	278	2.92
3	124	4.38
4	70	5.84
5	45	7.30

In-Finity Suspension Down 100 mm

Light Source: Top LED 25,5W/m - 3110 lm/m - 3000K/CRI 80 / 25,5W/m - 3265 lm/m - 4000K/CRI 80

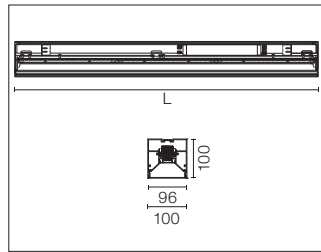

LED-Beleuchtungssystem in Modulbauweise für abgehängte Montage bestehend aus LED-Modulen, Aluminiumprofil und Diffusor. Die Treiber für direkten Netzanschluss 220-240V oder für den Anschluss an andere Module des Systems sind in den Leuchtmodulen inbegriffen. Befestigungsset nicht enthalten.

LED modular system for suspended installation, including LED luminaires, aluminum installation profile, and diffusers. Drivers included in lighting modules for 220-240V connection to mains or to other lighting modules. Suspension kit not included.

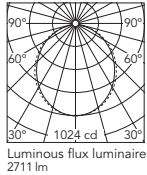

Beam Angle: 103°

h(m)	E(lx)	D(m)
1	1024	2.54
2	256	5.07
3	114	7.61
4	64	10.14
5	41	12.68

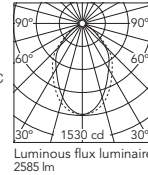

Beam Angle: 73°

h(m)	E(lx)	D(m)
1	1530	1.47
2	383	2.95
3	170	4.42
4	96	5.90
5	61	7.37

IN - FINITY

In-Finity Suspension Up&Down 35 mm

Light Source: Top LED 31,5W/m - 1785 lm/m UP - 2665 lm/m DOWN - 3000K/CRI 80 / 31,5W/m - 1875 lm/m UP - 2800 lm/m DOWN - 4000K/CRI 80

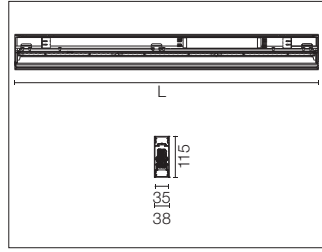

LED-Beleuchtungssystem in Modulbauweise für abgehängte Montage bestehend aus LED-Modulen, Aluminiumprofil und Diffusor. Die Treiber für direkten Netzanschluss 220-240V oder für den Anschluss an andere Module des Systems sind in den Leuchtmodulen inbegriffen. Befestigungsset enthalten.

LED modular system for suspended installation, including LED luminaires, aluminum installation profile, and diffusers. Drivers included in lighting modules for 220-240V connection to mains or to other lighting modules. Suspension kit included.

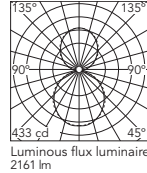

Beam Angle DIR: 110°

h(m)	E(lx)	D(m)
1	433	2.84
2	108	5.68
3	48	8.52
4	27	11.36
5	17	14.19

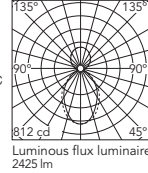

Beam Angle DIR: 76°

h(m)	E(lx)	D(m)
1	812	1.55
2	203	3.11
3	90	4.66
4	51	6.22
5	32	7.77

In-Finity Suspension Up&Down 70 mm

Light Source: Top LED 38W/m - 1785 lm/m UP - 2985 lm/m DOWN - 3000K/CRI 80 / 38W/m - 1875 lm/m UP - 3135 lm/m DOWN - 4000K/CRI 80

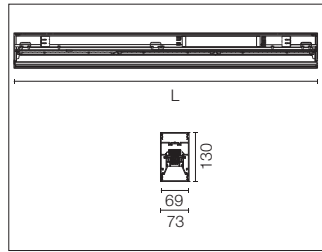

LED-Beleuchtungssystem in Modulbauweise für abgehängte Montage bestehend aus LED-Modulen, Aluminiumprofil und Diffusor. Die Treiber für direkten Netzanschluss 220-240V oder für den Anschluss an andere Module des Systems sind in den Leuchtmodulen inbegriffen. Befestigungsset enthalten.

LED modular system for suspended installation, including LED luminaires, aluminum installation profile, and diffusers. Drivers included in lighting modules for 220-240V connection to mains or to other lighting modules. Suspension kit included.

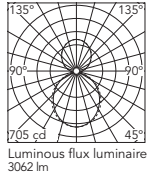

Beam Angle DIR: 103°

h(m)	E(lx)	D(m)
1	705	2.51
2	176	5.03
3	78	7.54
4	44	10.05
5	28	12.57

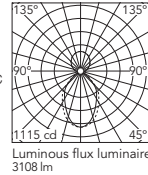

Beam Angle DIR: 72°

h(m)	E(lx)	D(m)
1	1115	1.46
2	279	2.92
3	124	4.38
4	70	5.84
5	45	7.30

In-Finity Suspension Up&Down 100 mm

Light Source: Top LED 38,5W/m - 1785 lm/m UP - 3110 lm/m DOWN - 3000K/CRI 80 / 38,5W/m - 1875 lm/m UP - 3265 lm/m DOWN - 4000K/CRI 80

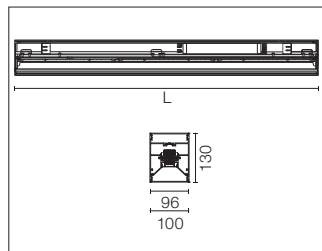

LED-Beleuchtungssystem in Modulbauweise für abgehängte Montage bestehend aus LED-Modulen, Aluminiumprofil und Diffusor. Die Treiber für direkten Netzanschluss 220-240V oder für den Anschluss an andere Module des Systems sind in den Leuchtmodulen inbegriffen. Befestigungsset enthalten.

LED modular system for suspended installation, including LED luminaires, aluminum installation profile, and diffusers. Drivers included in lighting modules for 220-240V connection to mains or to other lighting modules. Suspension kit included.

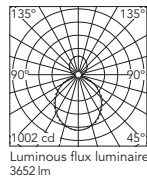

Beam Angle DIR: 103°

h(m)	E(lx)	D(m)
1	1002	2.54
2	250	5.07
3	111	7.61
4	63	10.14
5	40	12.68

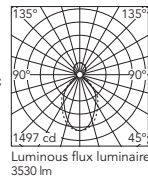

Beam Angle DIR: 73°

h(m)	E(lx)	D(m)
1	1497	1.47
2	374	2.95
3	166	4.42
4	94	5.90
5	60	7.37

IN - FINITY

Zubehör / Accessories

Metallverschluss für die verschiedenen Profile.
2 Stück pro Set.

Metal end cap for the different profiles.
2 unit kit.

Flos Architectural für eine Konfiguration ohne end caps kontaktieren.

Contact Flos Architectural team for a configuration without end caps.

*Die Ausführung Recessed No Trim ist nur in Weiss (40) erhältlich.

*No Trim Recessed version is only available in white finish (40).



Recessed Trim

35 mm

- 08.9051.40
- 08.9051.02
- 08.9051.NS

70 mm

- 08.9053.40
- 08.9053.02
- 08.9053.NS

100 mm

- 08.9055.40
- 08.9055.02
- 08.9055.NS

Recessed No Trim* / Surface / Suspension Down

35 mm

- 08.9050.40
- 08.9050.02
- 08.9050.NS

70 mm

- 08.9052.40
- 08.9052.02
- 08.9052.NS

100 mm

- 08.9054.40
- 08.9054.02
- 08.9054.NS

Suspension Up&Down

35 mm

- 08.9056.40
- 08.9056.02
- 08.9056.NS

70 mm

- 08.9057.40
- 08.9057.02
- 08.9057.NS

100 mm

- 08.9058.40
- 08.9058.02
- 08.9058.NS

Einzelstück Hängeset (L = 4 m). Maximale Entfernung zwischen den Befestigungskabeln: 2 m. Abmessungen Deckendübel (h=63mm, d=22mm) und Dübel am Profil (l=36mm a=24mm h=9mm)

One unit suspension kit (L = 4 m). Maximum distance between the suspension cables: 2 m. Ceiling anchor dimensions (h=63mm, d=22mm) and anchor to profile (l=36mm a=24mm h=9mm)



08.0030

Anschlussrosette für den hängenden Einbau von In-Finity. Die Standardausführung wird mit dreipoligem Kabel für einfache Schaltung geliefert. Die Ausführung Dali wird mit fünfpoligem Kabel geliefert, das für unabhängige Doppelschaltung der indirekten und direkten Beleuchtung in der Standardversion Up&Down eingesetzt werden kann. Mit 4 m langem Abhängkabel.

Power supply rose for the hanging installation of the In-finity. The standard version comes with a three-pole cable for basic switching. The Dali version comes with a five-pole cable that can be used for double switching, independent from the direct and indirect lighting in the standard Up&Down version. Includes a 4 m suspension cable.



08.0031.00
Dali Version
08.0031.00.DA

500 mm opaler diffusor. Diffuse, gleichmäßige und blendfreie Raumbelichtung. Zubehör zum Ausfüllen von Lücken in Gebäuden mit Ecken oder Längen von mehr als 3 m.

500 mm opal diffuser. Diffuse, glare free and uniform lighting throughout the room. Accessory to fill gaps in structures with corners or longer than 3 meters.



In-Finity 35
08.0109.00
In-Finity 70
08.0110.00
In-Finity 100
08.0111.00

500 mm mikroprismatischer diffusor. Hochwirksamer Diffusor, der durch seine einzigartige, mehrlagige mikro-prismatische Struktur für eine blendfreie Beleuchtung im UGR<19 Winkel sorgt. Zubehör zum Ausfüllen von Lücken in Gebäuden mit Ecken oder Längen von mehr als 3 m.

500 mm micro-prismatic diffuser. Highly efficient multilayer diffuser that, thanks to its unique micro-prismatic texture, provides a glare free UGR<19 light beam. Accessory to fill gaps in structures with corners or longer than 3 meters.



In-Finity 35
08.0112.00
In-Finity 70
08.0113.00
In-Finity 100
08.0114.00

LED SQUAD&MINI
DESIGNED BY FLOS ARCHITECTURAL

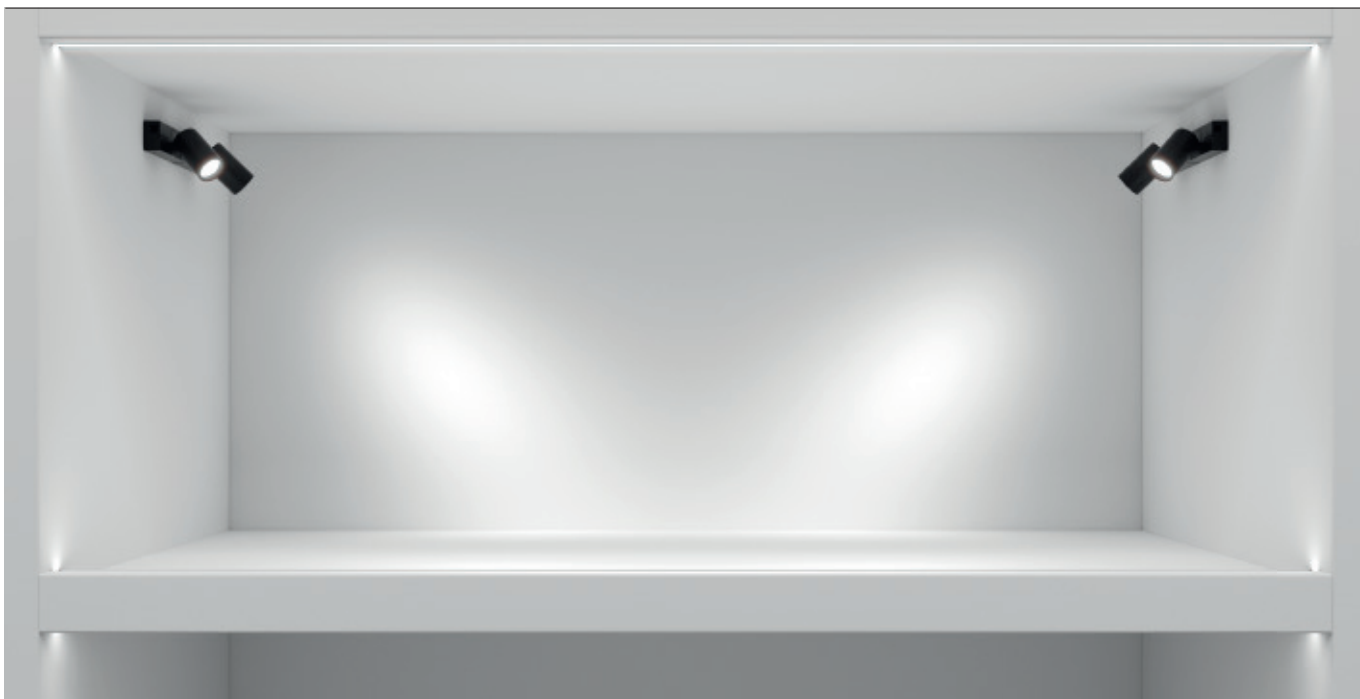

LED SQUAD
MINI



LIGHT SOURCE
POWER LED
17W/m
24V
1900 lm/m
3000K/CRI 90

LED SQUAD



LIGHT SOURCE
TOP LED
25W/m
24V
2500 lm/m
3000K/CRI 90

LED SQUAD
1 SPOT



LIGHT SOURCE
POWER LED
4W
24V
220 lm
3000K/CRI 80

LED SQUAD
2 SPOTS



LIGHT SOURCE
POWER LED
6W
24V
2x220 lm
3000K/CRI 80

LED Squad Mini

29 Eloxiertes Aluminium
29 Anodized Aluminium



LED Squad

29 Eloxiertes Aluminium
29 Anodized Aluminium

AN Eloxiertes Schwarz
AN Anodized Black



LED Squad Spot

30 Weiss
30 White

02 Grau
02 Grey

14 Schwarz
14 Black



LED SQUAD & MINI

Produktbeschreibung

Lichtquelle mit LED-Lampe für die Oberflächeninstallation, bestehend aus einem Profil aus stranggepresstem Aluminium mit integrierten linearen LED-Modulen. Verfügt über einen Opaldiffusor für eine optimale Lichtstreuung sowie über Schnellanschlüsse, um Module unterschiedlicher Länge miteinander verbinden zu können. Die Version Spot besteht aus einem Aluminium-Optikkörper, in den eine Hochleistungs-LED integriert wird. Die optische Steuerung erfolgt über Linsen mit drei Öffnungswinkeln.

Betriebsgerät

Das System benötigt eine 24-V-Stromversorgung, die durch Netzgeräte mit 20W und 60W gesichert wird. Maximale Länge von LED-Modulen, die über ein Netzgerät gespeist werden:

- LED Squad: 2 m (60W).
- LED Squad Mini: 3x1,118 m (60W).

Maximale Anzahl untereinander verbundener Spots mit einem Netzgerät: 6 Spots.

Zusatzinformationen

Maximale Leistung mit einem 60-W-Netzgerät.
Schutzgrad IP20.
Schutzklasse III.

Qualitätszeichen

Das Gerät entspricht der europäischen technischen Norm EN60598-1 und den entsprechenden Zusatzregelungen.

Description

Luminaire to be installed on surface with LED light source. Made out of aluminium extrusion profile in which linear LED modules are incorporated. It has an opal diffuser to obtain perfect light diffusion and quick connectors to be able to make joints between different length modules.

The Spot version is made up of an aluminium optical body which includes a high performance power LED. Optical control is made using lenses, with three opening angles.

Power Supply

The system is powered at 24V, and has 20W and 60W power supplies.

Maximum length of LED modules powered from a power supply:

- LED Squad: 2 m (60W).
- LED Squad Mini: 3x1,118 m (60W).

Maximum number of spots connected together with a power supply: 6 spots.

Additional Information

Maximum power with a 60W power supply.
IP20 protection grade.
Insulation class III.

Standard Compliance and Quality Marks

EN60598-1 European Technical Standards and any subsequent additions.



Led Squad



Led Squad Spot

LED SQUAD & MINI

LED Squad Mini

Light Source: Top LED 17 W/m - 24V - 1900 lm/m - 3000K/CRI 90

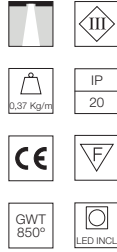
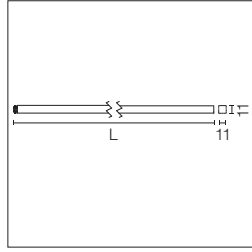

Leuchte zum Aufstellen mit LED-Lichtquelle. Bestehend aus einem stranggepressten Aluminiumprofil, in das lineare LED-Module eingebaut sind. Unsichtbare Punkte bei Dauerlicht. Es verfügt über einen Schnellanschluss, mit dem Module unterschiedlicher Länge ohne Verkabelung verbunden werden können. Es verfügt über ein magnetisches Befestigungssystem an Metalloberflächen oder Bügeln zum Anschrauben an herkömmliche Oberflächen.

Luminaire for surface installation with LED light source. Composed of an extruded aluminum profile to which LED linear modules are incorporated. Invisible dots with continuous light. It has a fast connector in order to join modules of different lengths without wiring. It has a magnetic fixing system on metal surfaces or brackets to screw on conventional surfaces.

Installationskabel und Treiber nicht enthalten. Muss separat bestellt werden.
Nicht mit Spots kompatibel.
Non dimmable.

Installation cables and driver not included. To be ordered separately.
Not compatible with spots.
Non dimmable.

L: 100 mm

1,5W - 190 lm

03.4060.29

10 Units Kit

03.4060.29.1Y

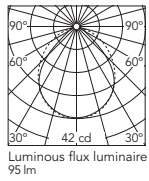

Beam Angle: 88°

L: 563 mm

8,8W - 1070 lm

03.4063.29

10 Units Kit

03.4063.29.1Y

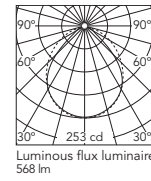

Beam Angle: 88°

L: 193 mm

2,9W - 367 lm

03.4061.29

10 Units Kit

03.4061.29.1Y

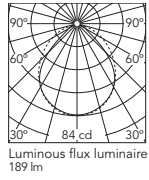

Beam Angle: 88°

L: 841 mm

13,2W - 1598 lm

03.4064.29

10 Units Kit

03.4064.29.1Y

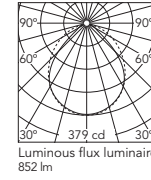

Beam Angle: 88°

L: 285 mm

4,4W - 542 lm

03.4062.29

10 Units Kit

03.4062.29.1Y

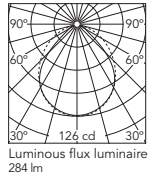

Beam Angle: 88°

L: 1118 mm

17,6W - 2125 lm

03.4065.29

10 Units Kit

03.4065.29.1Y

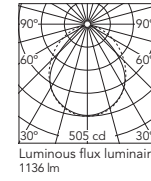

Beam Angle: 88°

LED Squad

Light Source: Top LED 25 W/m - 24V - 2500 lm/m - 3000K/CRI 90

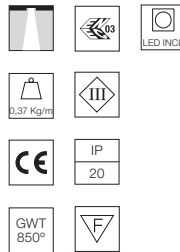
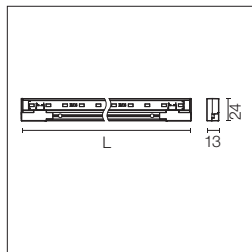

Wandlichtquelle für die direkte/ indirekte LED-Beleuchtung. Ferntransformator wird nicht mitgeliefert. Dimmable.

Direct/indirect lighting wall luminaire with LED. Remote transformer not included. Dimmable.

Installationskabel eingeschlossen: Stromkabel 500 mm. Verbindungskabel 60 mm.

Installation cables included: Power cable 500 mm. Connection cable 60 mm.

L: 125 mm

3,2W - 313 lm - 7 LEDs

03.3960.29B

03.3960.ANB

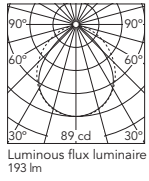

Beam Angle: 86°

L: 1000 mm

25W - 2500 lm - 56 LEDs

03.3963.29B

03.3963.ANB

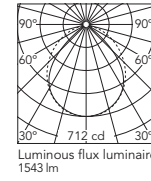

Beam Angle: 86°

L: 500 mm

12,5W - 1250 lm - 28 LEDs

03.3962.29B

03.3962.ANB

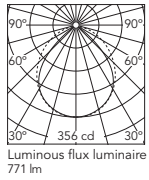

Beam Angle: 86°

LED SQUAD & MINI

LED Squad 1 Spot

Light Source: Power LED 4W - 24V - 220 lm - 3000K/CRI 80

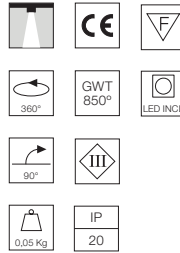
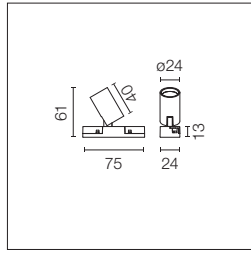

Projektor für die Oberflächeninstallation. Netzgerät wird nicht mitgeliefert. Dimmable.

Installationskabel eingeschlossen: Stromkabel 500 mm. Verbindungskabel 60 mm.

Surface mounted spotlight. Power supply not included. Dimmable.

Installation cables included: Power cable 500 mm. Connection cable 60 mm.

- 03.3970.30A
- 03.3970.02A
- 03.3970.14A

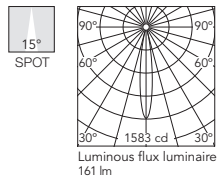

Beam Angle: 15°

h(m)	E(lx)	D(m)
1	1583	0.27
2	396	0.54
3	176	0.81
4	99	1.08
5	63	1.35

- 03.3972.30A
- 03.3972.02A
- 03.3972.14A

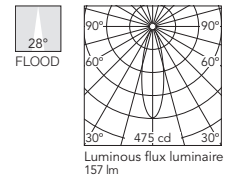

Beam Angle: 28°

h(m)	E(lx)	D(m)
1	475	0.49
2	119	0.99
3	53	1.48
4	30	1.98
5	19	2.47

- 03.3971.30A
- 03.3971.02A
- 03.3971.14A

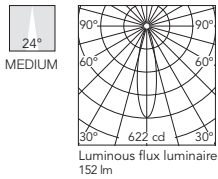

Beam Angle: 24°

h(m)	E(lx)	D(m)
1	622	0.43
2	156	0.85
3	69	1.28
4	39	1.71
5	25	2.13

LED Squad 2 Spots

Light Source: Power LED 6W - 24V - 2x220 lm - 3000K/CRI 80

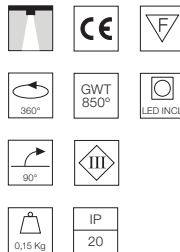
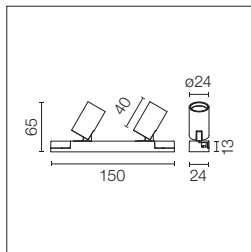

Projektor für die Oberflächeninstallation. Netzgerät wird nicht mitgeliefert. Non Dimmable.

Installationskabel eingeschlossen: Stromkabel 500 mm. Verbindungskabel 60 mm.

Surface mounted spotlight. Power supply not included. Non Dimmable.

Installation cables included: Power cable 500 mm. Connection cable 60 mm.

- 03.3975.30A
- 03.3975.02A
- 03.3975.14A

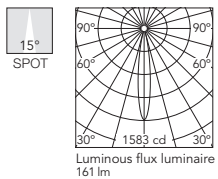

Beam Angle: 15°

h(m)	E(lx)	D(m)
1	1583	0.27
2	396	0.54
3	176	0.81
4	99	1.08
5	63	1.35

- 03.3977.30A
- 03.3977.02A
- 03.3977.14A

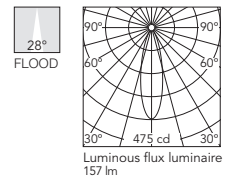

Beam Angle: 28°

h(m)	E(lx)	D(m)
1	475	0.49
2	119	0.99
3	53	1.48
4	30	1.98
5	19	2.47

- 03.3976.30A
- 03.3976.02A
- 03.3976.14A

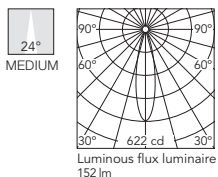

Beam Angle: 24°

h(m)	E(lx)	D(m)
1	622	0.43
2	156	0.85
3	69	1.28
4	39	1.71
5	25	2.13

LED SQUAD & MINI

Treiber / Drivers

LED Squad / LED Squad Mini

Elektronischer Transformator für LED mit beständiger Spannung (24V) – 100/240V.

Electronic transformer with constant voltage (24V) for LED. 100/240V.

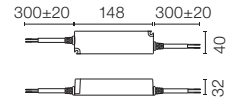

25W
60.8703

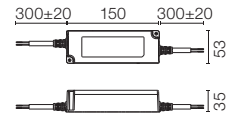

60W
60.9089

LED Squad: außer 2 Spots version / except for 2 Spots version

Steuereinheit für 1-10V-Dimmung; 1-Kanal-Steuerung für 24V-LED-Module; Netzgerät nicht inbegriffen. Max. 120W - 5A.

Dimmable 1-10V control unit with 1 channel for 24V LED modules. Power supply not included. Max. 120W - 5A.

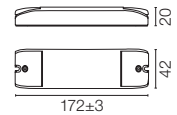

60.8640

Steuereinheit für Dali-Dimmung; für 12 bis 48V-LED-Module; Netzgerät nicht inbegriffen.

Dimmable Dali control unit for 12 to 48V LED modules. Power supply not included.

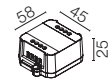

60.9678

LED Squad Mini

Stromkabel 2500 mm.

Feed cable 2500 mm.



06.0097.00

Verbindungskabel 150 mm.

Connection cable 150 mm.



06.0098.00

LIGHT CUT MINI

DESIGNED BY FLOS ARCHITECTURAL





PERIMETRAL

70 mm

140 mm



SPOTS MODULES

				
LIGHT SOURCE LED ARRAY 18W 1850 lm 3000K/CRI 90	LIGHT SOURCE LED ARRAY 14,4W 1780 lm 3000K/CRI 80 14,4W 1440 lm 3000K/CRI 90	LIGHT SOURCE POWER LED 10W 840 lm 3000K/CRI 80	LIGHT SOURCE PHOSPHOR LED 17W 1400 lm 3000K/CRI 98 18W 1870 lm 3000K/CRI 80	LIGHT SOURCE LED QR-CBC 51 GX5.3

□ 30 Mattweiss
30 Matt White

■ 14 Mattschwarz
14 Matt Black



LIGHT CUT MINI

Produktbeschreibung

Beleuchtungssystem bestehend aus einem stranggepressten Profil, das sich perfekt in Gipskartondecken integrieren lässt. LED- oder Halogenlampen Strahler können als Akzentlicht auf einfache Weise angebracht werden. Die Projektoren können direkt auf dem Profil installiert und mit einer Fernsteuerung der Klasse II genutzt werden. Darüber hinaus werden sie je nach Installationsart in zwei Größen angeboten und verfügen über Zubehör zur Optimierung des visuellen Komforts und über Farbfilter.

Zusatzinformationen

Nur auf Flächen aus Gipskarton mit 12,5 mm Stärke installierbar.
Es ist möglich die Profile auf jede Größe zuzuschneiden. Schutzgrad IP20.
Auf normal entflammaren Oberflächen einsetzbar.

Qualitätszeichen

Das Gerät entspricht der europäischen technischen Norm EN60598-1 und den entsprechenden Zusatzregelungen.

Description

Lighting system comprising an extruded profile which integrates perfectly in plasterboard ceilings. It is prepared for the simple integration of lighting with LED or halogens projectors. The projectors are prepared for installation directly on the profile, with Class II remote equipment. Furthermore, they are available in two sizes depending on the installation. It has accessories for visual comfort optimization and colour filters.

Additional Information

Can only be installed in 12.5 mm thick plaster-board. It is possible to cut the profiles to any size. IP20 protection grade. Suitable for installation on normally inflammable surfaces.

Standard Compliance and Quality Marks

EN60598-1 European Technical Standards and any subsequent additions.



Profiles



Spot Module



Spot Module
Electrical
Connection

LIGHT CUT MINI – PROFILES

Installation des Kanals 70 / Kanals 140

Struktursystem in Aluminiumausführung für den Einbau in Gipskartondecken. Ermöglicht die Installation von Projektoren. Für die Kanalinstallation werden Profile zu je 1 oder 2 Metern sowie doppelte Innen- und Außenecken genutzt. Es ist möglich die Profile auf jede Größe zuzuschneiden.

Channel 70 / Channel 140 Installation

Structural system in aluminium to integrate in plasterboard ceilings. It allows incorporation of projectors. Channel installation consists of 1 or 2 meter profiles, double inside and outside corners. It is possible to cut the profiles to any size.

Aluminiumprofil. Set mit 2 Stück.

Aluminium profile. 2 unit kit.

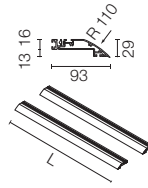

Channel 70 / 140

L: 1000 mm

08.8720.30
08.8720.14

L: 2000 mm

08.8721.30
08.8721.14

Endkappe.

End cap.

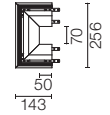
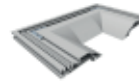

Channel 70

08.8705.30
08.8705.14

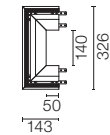

Channel 140

08.8706.30
08.8706.14

Winkel.

Corner.

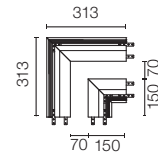

Channel 70

08.8707.30
08.8707.14

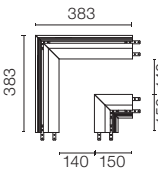

Channel 140

08.8708.30
08.8708.14

Perimetrische Installation

Struktursystem in Aluminiumausführung für den Einbau in Gipskartondecken. Ermöglicht die Installation von Projektoren. Für die perimetrale Installation werden Profile zu je 1 oder 2 Metern, Innenecken und Außenecken genutzt. Es ist möglich die Profile auf jede Größe zuzuschneiden.

Perimetral Installation

Structural system in aluminium to integrate in plasterboard ceilings. It allows incorporation of projectors. Perimetral installation consists of 1 or 2 meter profiles, inside and outside corners. It is possible to cut the profiles to any size.

Aluminiumprofil. Set mit 1 Stück.

Aluminium profile. 1 unit kit.

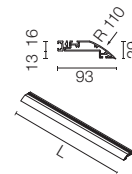

L: 1000 mm

08.8701.30
08.8701.14

L: 2000 mm

08.8702.30
08.8702.14

Innenwinkel.

Inner corner.

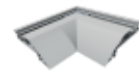

08.8709.30

08.8709.14

Außenwinkel.

Outer corner.



08.8710.30

08.8710.14

Zubehör für vertikalecke.

Accessory for vertical corner.

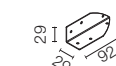

08.8711.00

LIGHT CUT MINI – SPOTS

Spot Module Power LED

Light Source: Power LED DC 900 mA - 10W - 840 lm - 3000K/CRI 80

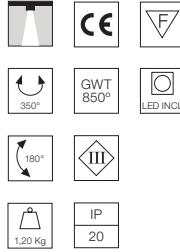
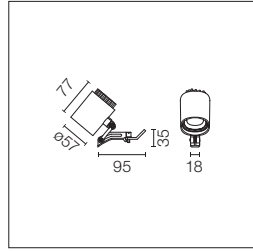

Projektor für die Installation in Light Cut Mini Systemen. Fernbedientes Konstantstrom-Netzgerät nicht im Lieferumfang enthalten.

Spotlight to be installed on Light Cut Mini system. Remote continuous current supply source not included.

Empfohlene Netzgeräte / Recommended power supply*:
 Non Dimmable 220-240V 60.9162
 Dimmable 0/1-10V 110-240V 60.9188
 Dimmable DALI 2 110-240V 60.9186
 Mains Dimming 220-240V 60.9467
 Casambi 220-240V 60.9207

* Siehe Treiberkapitel / Refer to the Drivers chapter

09.0220.30A
09.0220.14A

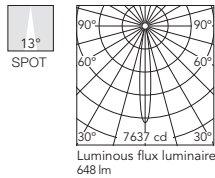

Beam Angle: 13°	h(m)	E(lx)	D(m)
1	7637	0.23	
2	1909	0.46	
3	849	0.69	
4	477	0.92	
5	305	1.14	

09.0221.30A
09.0221.14A

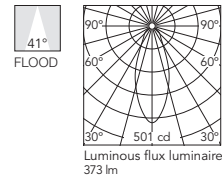

Beam Angle: 41°	h(m)	E(lx)	D(m)
1	501	0.75	
2	125	1.50	
3	56	2.25	
4	31	3.00	
5	20	3.75	

Spot Module Phosphor LED

Light Source: Phosphor LED DC 650 mA - 18W - 1870 lm - 3000K/CRI 80 / DC 700 mA - 17W - 1400 lm - 3000K/CRI 98

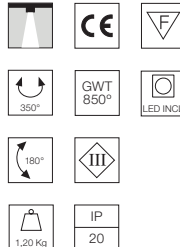
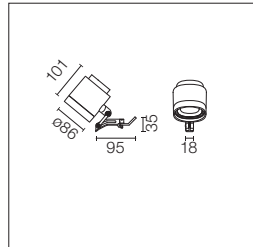

Projektor für die Installation in Light Cut Mini Systemen. Fernbedientes Konstantstrom-Netzgerät nicht im Lieferumfang enthalten.

Spotlight to be installed on Light Cut Mini system. Remote continuous current supply source not included.

Nur für den Kanal 140 anwendbar.

Only for Channel 140 installation.

Empfohlene Netzgeräte / Recommended power supply*:
 Non Dimmable 220-240V 60.9162
 Dimmable 0/1-10V 110-240V 60.9188
 Dimmable DALI 2 110-240V 60.9186
 Mains Dimming 220-240V 60.9467
 Casambi 220-240V 60.9207

* Siehe Treiberkapitel / Refer to the Drivers chapter

CRI 80
09.0230.30
09.0230.14

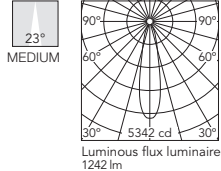

Beam Angle: 23°	h(m)	E(lx)	D(m)
1	5342	0.41	
2	1336	0.81	
3	594	1.22	
4	334	1.63	
5	214	2.03	

CRI 98
09.0232.30
09.0232.14

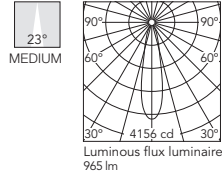

Beam Angle: 23°	h(m)	E(lx)	D(m)
1	4156	0.41	
2	1039	0.81	
3	462	1.22	
4	260	1.63	
5	166	2.04	

CRI 80
09.0231.30
09.0231.14

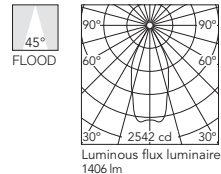

Beam Angle: 45°	h(m)	E(lx)	D(m)
1	2542	0.84	
2	636	1.68	
3	282	2.52	
4	159	3.35	
5	102	4.19	

CRI 98
09.0233.30
09.0233.14

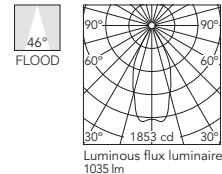

Beam Angle: 46°	h(m)	E(lx)	D(m)
1	1853	0.85	
2	463	1.70	
3	206	2.54	
4	116	3.39	
5	74	4.24	

Spot Module QR-CBC 51

Light Source: LED QR-CBC 51 GX5.3

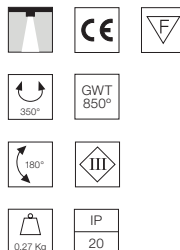
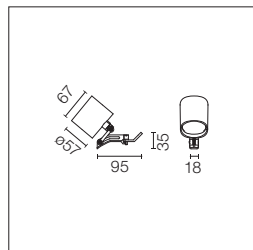

Projektor für die Installation in Light Cut Mini Systemen. Fernbedienter elektronischer Transformator nicht im Lieferumfang enthalten

Spotlight to be installed on Light Cut Mini system. Electronic transformer remote not included.

09.0203.30
09.0203.14

LIGHT CUT MINI

Zubehör / Accessories

Spot module: Power LED / QR-CBC 51

Abschirmzubehör.
Screening cylinder.



08.8380.30
08.8380.14

Filterhalter aus injiziertem
aluminium.



08.8363.30
08.8363.14

Filter-holder made from injected
aluminium.

Honeycomb
Honeycomb



08.8182.14

Blauer filter
Blue filter



08.8230.64.OD

Hellblauer filter
Sky blue filter



08.8230.65.OD

Amber filter
Amber filter



08.8230.66.OD

Roter filter
Red filter



08.8230.67.OD

U.V. filter
U.V. filter



08.8230.98.OD

Hot light
Hot light



08.8230.69

Cold light
Cold light



08.8230.CL

Daylight
Daylight



08.8230.DL

Neodimium
Neodimium



08.8230.ND

Spot module: LED Array 14,4W

Honeycomb
Honeycomb



08.8502.14

Blauer filter
Blue filter



08.8501.64.OD

Hellblauer filter
Sky blue filter



08.8501.65.OD

Amber filter
Amber filter



08.8501.66.OD

Roter filter
Red filter



08.8501.67.OD

Hot light
Hot light



08.8501.69

Cold light
Cold light



08.8501.CL

Daylight
Daylight



08.8501.DL

Neodimium
Neodimium



08.8501.ND

Spot module: LED Array 18W

Honeycomb
Honeycomb



08.3309.14

Elliptische linse
Elliptical lens



08.8627.68

Floodlinse
Flood lens



08.3310.19

HIGH COMFORT

Oblique Floor, Oblique, Light Shadow,
Light Shadow Pro&Dots, Circle of Light,
LED Curtain.

OBLIQUE FLOOR

DESIGNED BY VINCENT VAN DUYSSEN



LIGHT SOURCE
 TOP LED
 8W
 750 lm
 2700K/CRI 90
 800 lm
 3000K/CRI 90
 850 lm
 4000K/CRI 90

DY Weiss
 DY Matt White

AH Glanzgrau
 AH Gloss Grey

DX Rost
 DX Matt Rust

DW Braun
 DW Matt Brown

DR Anthrazit
 DR Matt Anthracite

DV Salbei-Glanz
 DV Gloss Salvia



Produktbeschreibung

Stehleuchte mit asymmetrischer direkter Beleuchtung und Bodenständer. Haptische Interaktion beim Schalten und Dimmen. Gehäuse aus Aluminiumdruckguss. Kopf aus Aluminiumdruckguss mit asymmetrischer Linse mit vollem Cut-Off, integriert in spritzgegossenem Methacrylat. Struktur aus stranggepresstem, mechanisch bearbeitetem Rohr aus Aluminiumlegierung. Völlig unsichtbare LED-Quellen für maximalen visuellen Komfort ohne Blenden oder Blendschutzzubehör, das die Leistung der Leuchte einschränkt. Die spezielle, patentierte Optikeinheit übertrifft die üblichen Beleuchtungsstandards für Anwendungen in Wohn-, Arbeits- und Lernumgebungen mit hohem Blendschutz und hervorragender Lichtqualität.

Betriebsgerät

Elektronischer Transformator 100-240 V - 50/60 Hz.

Zusatzinformationen

Schutzgrad IP20.
 Schutzklasse III.

Qualitätszeichen

Das Gerät entspricht der europäischen technischen Norm EN60598-1 und den entsprechenden Zusatzregelungen.

Description

Floor lamp with asymmetrical direct lighting and floor stand. Haptic interaction for switching and dimming. Cast aluminum body. Cast aluminum head with integrated full cut-off asymmetric lens in injection molded methacrylate. Structure made of a mechanically worked extruded aluminum alloy tube. Completely invisible LED sources for maximum visual comfort without the need for diaphragms or anti-glare accessories that limit the performance of the luminaire. The patented special optical unit exceeds the usual lighting standards for applications in residential, work and study environments with high glare protection and outstanding light quality.

Power Supply

100-240 V - 50/60 Hz electronic transformer.

Additional Information

IP20 protection grade.
 Insulation class III.

Standard Compliance and Quality Marks

EN60598-1 European Technical Standards and any subsequent additions.

Oblique Floor

Light Source: Top LED 8W - 24V - 750 lm - 2700K/CRI 90 / 8W - 24V - 800 lm - 3000K/CRI 90 / 8W - 24V - 850 lm - 4000K/CRI 90

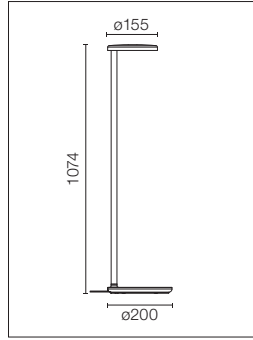

Stehleuchte, die dank ihrer innovativen, patentierten Linse eine asymmetrische Lichtverteilung bietet und gleichzeitig einen hohen Sehkomfort gewährleistet. Ihre Form, Höhe und Abmessungen stehen im Einklang mit der Funktionalität des Produkts, das eine hervorragende Beleuchtung zum Lesen oder als Begleiter bietet, wobei die Lichtquelle dem Blick des Benutzers verborgen bleibt.

Floor lamp that, thanks to its innovative patented lens, offers asymmetrical light distribution and excellent visual comfort. Its shape, height and dimensions are consistent with the functionality of the product, which provides excellent reading or companion lighting while keeping the light source invisible to the user.

- 2700K**
- 09.8220.DY
 - 09.8220.AH
 - 09.8220.DX
 - 09.8220.DW
 - 09.8220.DR
 - 09.8220.DV

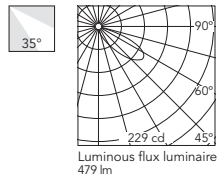

h(m)	E(lx)	D(m)
1	229	2.18
2	57	4.36
3	25	6.54
4	14	8.72
5	9	10.90

- 4000K**
- 09.8222.DY
 - 09.8222.AH
 - 09.8222.DX
 - 09.8222.DW
 - 09.8222.DR
 - 09.8222.DV

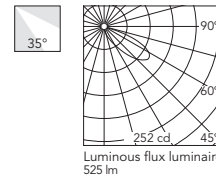

h(m)	E(lx)	D(m)
1	252	2.18
2	63	4.36
3	28	6.54
4	16	8.72
5	10	10.90

- 3000K**
- 09.8221.DY
 - 09.8221.AH
 - 09.8221.DX
 - 09.8221.DW
 - 09.8221.DR
 - 09.8221.DV

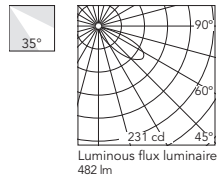

h(m)	E(lx)	D(m)
1	231	2.18
2	58	4.36
3	26	6.54
4	14	8.72
5	9	10.90

Oblique Floor USB-C

Light Source: Top LED 8W - 24V - 750 lm - 2700K/CRI 90 / 8W - 24V - 800 lm - 3000K/CRI 90 / 8W - 24V - 850 lm - 4000K/CRI 90

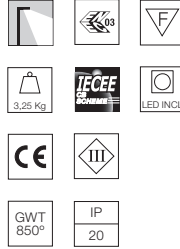
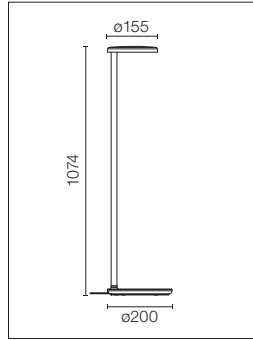

Stehleuchte, die dank ihrer innovativen, patentierten Linse eine asymmetrische Lichtverteilung bietet und gleichzeitig einen hohen Sehkomfort gewährleistet. Ihre Form, Höhe und Abmessungen stehen im Einklang mit der Funktionalität des Produkts, das eine hervorragende Beleuchtung zum Lesen oder als Begleiter bietet, wobei die Lichtquelle dem Blick des Benutzers verborgen bleibt. Modell mit mobiler USB-C-Ladestation in der Basis.

Floor lamp that, thanks to its innovative patented lens, offers asymmetrical light distribution and excellent visual comfort. Its shape, height and dimensions are consistent with the functionality of the product, which provides excellent reading or companion lighting while keeping the light source invisible to the user. Model with USB-C mobile charging in its base.

- 2700K**
- 09.8230.DY
 - 09.8230.AH
 - 09.8230.DX
 - 09.8230.DW
 - 09.8230.DR
 - 09.8230.DV

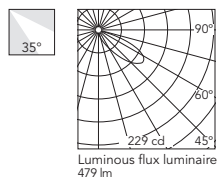

h(m)	E(lx)	D(m)
1	229	2.18
2	57	4.36
3	25	6.54
4	14	8.72
5	9	10.90

- 4000K**
- 09.8232.DY
 - 09.8232.AH
 - 09.8232.DX
 - 09.8232.DW
 - 09.8232.DR
 - 09.8232.DV

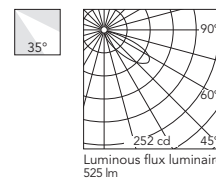

h(m)	E(lx)	D(m)
1	252	2.18
2	63	4.36
3	28	6.54
4	16	8.72
5	10	10.90

- 3000K**
- 09.8231.DY
 - 09.8231.AH
 - 09.8231.DX
 - 09.8231.DW
 - 09.8231.DR
 - 09.8231.DV

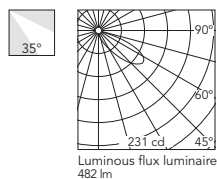

h(m)	E(lx)	D(m)
1	231	2.18
2	58	4.36
3	26	6.54
4	14	8.72
5	9	10.90

OBLIQUE

DESIGNED BY VINCENT VAN DUYSSEN



LIGHT SOURCE

TOP LED
8W
750 lm
2700K/CRI 90
800 lm
3000K/CRI 90
850 lm
4000K/CRI 90

DY Weiss
DY Matt White

AH Glanzgrau
AH Gloss Grey

DX Rost
DX Matt Rust

DW Braun
DW Matt Brown

DR Anthrazit
DR Matt Anthracite

DV Salbei-Glanz
DV Gloss Salvia



Produktbeschreibung

Tischleuchte mit direktem Licht und Halterung. Druckgegossener Aluminiumkörper. Druckgegossener Kopf mit asymmetrischer Vollschnittlinse, die in spritzgegossenes Methacrylat integriert ist. LED-Quellen sind für einen maximalen Sehkomfort völlig versteckt, ohne dass Membranen oder Blendschutz-Zubehör verwendet werden müssen, die die Leistung des Lampenkörpers einschränken. Die patentierte optische Spezialeinheit übertrifft die üblichen Beleuchtungsstandards für Anwendungen in Arbeits- und Bürobereichen, indem sie Beleuchtungswerte des Arbeitsbereichs von mehr als 1000 Lux mit hohem Blendungsschutz und minimiertem Flackern bietet. Die Lampenbasis ist bei allen Versionen mit einer USB-C-Buchse zum Laden kompatibler Geräte ausgestattet. Die Qi-Versionen verfügen über eine Polymeraußenabdeckung der Basis, die das zusätzliche drahtlose Laden mobiler Geräte ermöglicht. Struktur aus einem mechanisch bearbeiteten Rohr aus extrudierter Aluminiumlegierung. Der Dimmer-Regler und Ein-Aus-Schalter ist in der Leuchtenbasis integriert und verfügt über einen Timer.

Betriebsgerät

Elektronischer Transformator 100-240 V - 50/60 Hz.

Zusatzinformationen

Schutzgrad IP20.
Schutzklasse III.

Qualitätszeichen

Das Gerät entspricht der europäischen technischen Norm EN60598-1 und den entsprechenden Zusatzregelungen.

Description

Table lamp with direct light and support. Body in die-cast aluminium. Head in die-cast aluminium with integrated full cut-off asymmetric lens in injection moulded methacrylate. LED source completely hidden from view for the best visual comfort without diaphragms or anti-glare accessories that would limit the performance of the lamp. The special patented optics group exceeds regular lighting standards for application in work and study environments, producing lighting values on the work surface greater than 1000 lux with high glare protection and minimum flickering.

All lamp base versions are equipped with a USB-C connection to recharge compatible devices.

The Qi versions have an external polymer covering on the base that allows for supplementary charging of mobile devices via wireless. Structure made of an extruded tubular aluminium alloy produced mechanically.

The ON/OFF-dimmer switch is integrated into the base and features a timer.

Power Supply

100-240 V - 50/60 Hz electronic transformer.

Additional Information

IP20 protection grade.
Insulation class III.

Standard Compliance and Quality Marks

EN60598-1 European Technical Standards and any subsequent additions.

OBLIQUE

Oblique

Light Source: Top LED 8W - 24V - 750 lm - 2700K/CRI 90 / 8W - 24V - 800 lm - 3000K/CRI 90 / 8W - 24V - 850 lm - 4000K/CRI 90

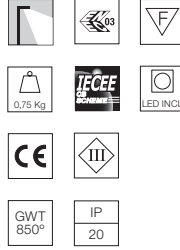
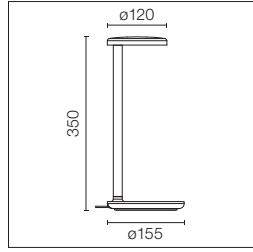

Profi-Tischlampe mit patentierter asymmetrischer Optik. Externes Netzteil mit einer Kabellänge von 1500 mm im Lieferumfang enthalten. In die Basis des Geräts integrierte USB-C-Buchse zum Laden kompatibler Geräte.

Professional table lamp with patented asymmetric optics. External power supply included with 1500-mm cable. USB-C connection integrated into the base of the device to recharge compatible devices.

2700K

- 09.8300.DY
- 09.8300.AH
- 09.8300.DX
- 09.8300.DW
- 09.8300.DR
- 09.8300.DV

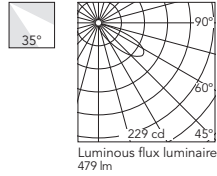

Beam Angle: 35°

h(m)	E(lx)	D(m)
1	229	2.18
2	57	4.36
3	25	6.54
4	14	8.72
5	9	10.90

4000K

- 09.8302.DY
- 09.8302.AH
- 09.8302.DX
- 09.8302.DW
- 09.8302.DR
- 09.8302.DV

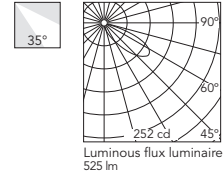

Beam Angle: 35°

h(m)	E(lx)	D(m)
1	252	2.18
2	63	4.36
3	28	6.54
4	16	8.72
5	10	10.90

3000K

- 09.8301.DY
- 09.8301.AH
- 09.8301.DX
- 09.8301.DW
- 09.8301.DR
- 09.8301.DV

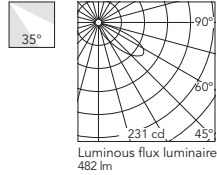

Beam Angle: 35°

h(m)	E(lx)	D(m)
1	231	2.18
2	58	4.36
3	26	6.54
4	14	8.72
5	9	10.90

Oblique Qi

Light Source: Top LED 8W - 48V - 750 lm - 2700K/CRI 90 / 8W - 48V - 800 lm - 3000K/CRI 90 / 8W - 48V - 850 lm - 4000K/CRI 90

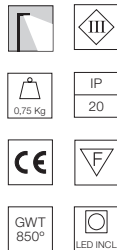
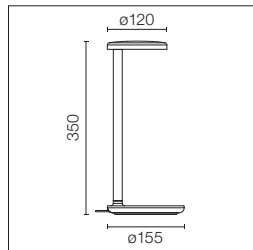

Profi-Tischlampe mit patentierter asymmetrischer Optik. Externes Netzteil mit einer Kabellänge von 1500 mm im Lieferumfang enthalten. In die Basis des Geräts integrierte USB-C-Buchse zum Laden kompatibler Geräte. Basis mit Qi-kompatiblem kabellosen Ladesystem für mobile Geräte und kabellosen Ladegehäusen für kompatible Geräte.

Professional table lamp with patented asymmetric optics. External power supply included with 1500-mm cable. USB-C connection integrated into the base of the device to recharge compatible devices. Base with Qi-compatible wireless recharging system for mobile devices and wireless recharging cases for compatible devices.

2700K

- 09.8310.DY
- 09.8310.AH
- 09.8310.DX
- 09.8310.DW
- 09.8310.DR
- 09.8310.DV

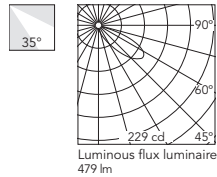

Beam Angle: 35°

h(m)	E(lx)	D(m)
1	229	2.18
2	57	4.36
3	25	6.54
4	14	8.72
5	9	10.90

4000K

- 09.8312.DY
- 09.8312.AH
- 09.8312.DX
- 09.8312.DW
- 09.8312.DR
- 09.8312.DV

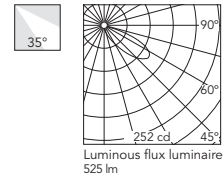

Beam Angle: 35°

h(m)	E(lx)	D(m)
1	252	2.18
2	63	4.36
3	28	6.54
4	16	8.72
5	10	10.90

3000K

- 09.8311.DY
- 09.8311.AH
- 09.8311.DX
- 09.8311.DW
- 09.8311.DR
- 09.8311.DV

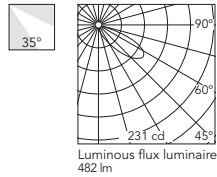

Beam Angle: 35°

h(m)	E(lx)	D(m)
1	231	2.18
2	58	4.36
3	26	6.54
4	14	8.72
5	9	10.90

FIXED
TRIM/NO TRIM
2 SPOTS



ADJUSTABLE
TRIM/NO TRIM
2 SPOTS



FIXED
TRIM/NO TRIM
4 SPOTS



ADJUSTABLE
TRIM / NO TRIM
4 SPOTS



FIXED
TRIM/NO TRIM
4 SPOTS SQUARE



FIXED
TRIM/NO TRIM
8 SPOTS*



ADJUSTABLE
TRIM/NO TRIM
8 SPOTS*



FIXED
TRIM/NO TRIM
12 SPOTS*



ADJUSTABLE
TRIM/NO TRIM
12 SPOTS*



WALL-WASHER
TRIM/NO TRIM
4 SPOTS



SURFACE
4 SPOTS



SURFACE
4 SPOTS SQUARE



LIGHT SOURCE
POWER LED
No dimmable/Dimmable
2,7W x Spot
270 lm x Spot
2700K/CRI 90
285 lm x Spot
3000K/CRI 90

LIGHT SOURCE
POWER LED
*Mains dimming
2,3W x Spot
225 lm x Spot
2700K/CRI 90
238 lm x Spot
3000K/CRI 90

Internal Finish

Light Shadow Fixed / Fixed Square
Adjustable / Surface / Surface Square

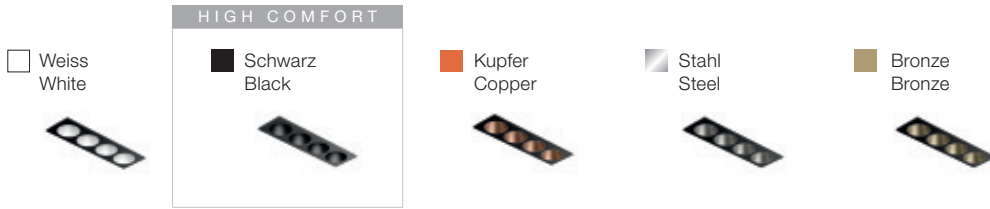

External Plate Finish

Light Shadow Fixed / Fixed Square
Adjustable / Surface / Surface Square



External Plate Finish

Light Shadow Wall-Washer



Box Finish

Light Shadow Surface / Surface Square

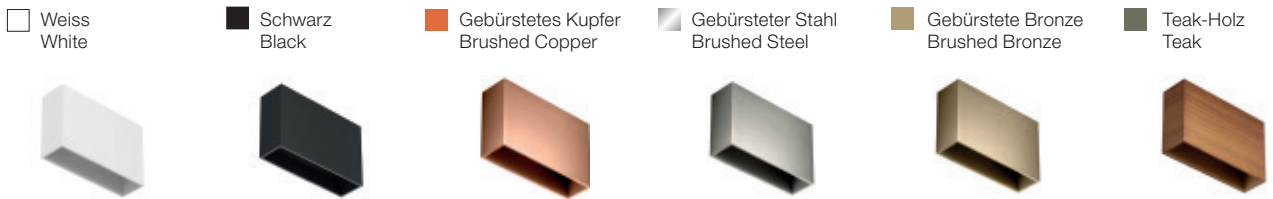

Light Shadow for The Running Magnet



Siehe Die Running Magnet Kollektion / See The Running Magnet collection

LIGHT SHADOW

DESIGNED BY FLOS ARCHITECTURAL

Produktbeschreibung

Innenbereichs-, Einbau- und Oberflächenleuchten. Aufgrund ihrer Haupteigenschaften, reduzierter Größe, Leistung und hervorragender Abschirmung, ermöglichen sie eine vollständige Integration in Räume. Die Produktreihe entstand aus dem Wunsch nach einer kompakten, einfach zu installierenden Leuchten mit dem unverwechselbaren Stil von Flos, die in Ausführungen mit schwarzen Abschirmkörpern eine hocheffiziente Beleuchtung unter Einhaltung höchster visueller Komfortanforderungen ermöglichen.

- Feste und verstellbare Einbauausführungen: 2/4/8/12 Spots (Trim / No Trim).
- Oberflächenausführung: 4 Spots.
- Version wall-washer: 4 spots (Trim / No Trim).

Die Produktreihe wird mit den Optiken Superakzent, Akzent und Allgemeinbeleuchtung angeboten. Um Lösungen in dekorativeren Umgebungen anzubieten, wurde die folgende Farbpalette mit einer Kombination aus Außen- und Innenlackierung entwickelt:

- Außenflächen: Schwarz und Weiß.
- Innenflächen: Weiß, Stahl, Bronze, Kupfer und Schwarz (hoher optischer Komfort).
- Außen-Box der Aufsatzausführung: schwarz, weiß, gebürsteter Stahl, gebürstete Bronze, gebürstetes Kupfer und Teakholz.

Einspeisung

DALI, Mains Dim und Casambi Versionen erhältlich. Siehe Modelle. 110V Version auf Nachfrage lieferbar.

Zubehör

Für die No Trim Version ist eine Vorinstallation mit Aluminium Einbaurahmen in Hohldecke notwendig. Muss separat bestellt werden (nicht nötig für die Trim Version).

Zusatzinformationen

Die No Trim Version ist für den Einbau in 12.5 mm Gipskartonplatten konzipiert. Schutzgrad IP20, IP23, IP44, IP55 je nach Modell. Schutzklasse II. Auf normal entflammaren Oberflächen einsetzbar.

Qualitätszeichen

Das Gerät entspricht der europäischen technischen Norm EN60598-1 und den entsprechenden Zusatzregelungen.

Description

Indoor, embedded and surface luminaires. Due to their main qualities (reduced size, high performance and great screening), they facilitate total integration into spaces. The family was born of the need for a compact, easy-to-install luminaire, with the distinctive Flos style, able to produce high efficiency lighting, while respecting the highest standards of visual comfort, in versions with black screening bodies.

- Fixed and adjustable embedded versions: 2/4/8/12 spots (Trim/No Trim).
- Fixed surface versions: 4 spots.
- Wall-washer version: 4 spots (Trim / No Trim).

The family is offered with super accented, accented and general lighting optics. For solutions in more decorative settings, the following range of colours has been developed, with a combination of interior and exterior painted finishes:

- exterior finishes: black and white.
- interior finishes: white, steel, bronze, copper and black (high comfort optics).
- outdoor box surface version: black, white, brushed steel, brushed bronze, brushed copper and teak.

Power Supply

DALI, Mains Dim and Casambi versions available. See models. Versions with 110V equipment available upon request.

Accessories

For the No Trim version, pre-installation frame in aluminium for false ceiling installation. It needs to be ordered separately (not necessary for Trim version).

Additional Information

No Trim version has been designed for 12.5 mm thick plasterboard installation. IP20, IP23, IP44, IP55 protection grade depending on the versions. Insulation class II. Suitable for installation on normally inflammable surfaces.

Standard Compliance and Quality Marks

EN60598-1 European Technical Standards and any subsequent additions.



Trim



No Trim



Surface



Continuous Line

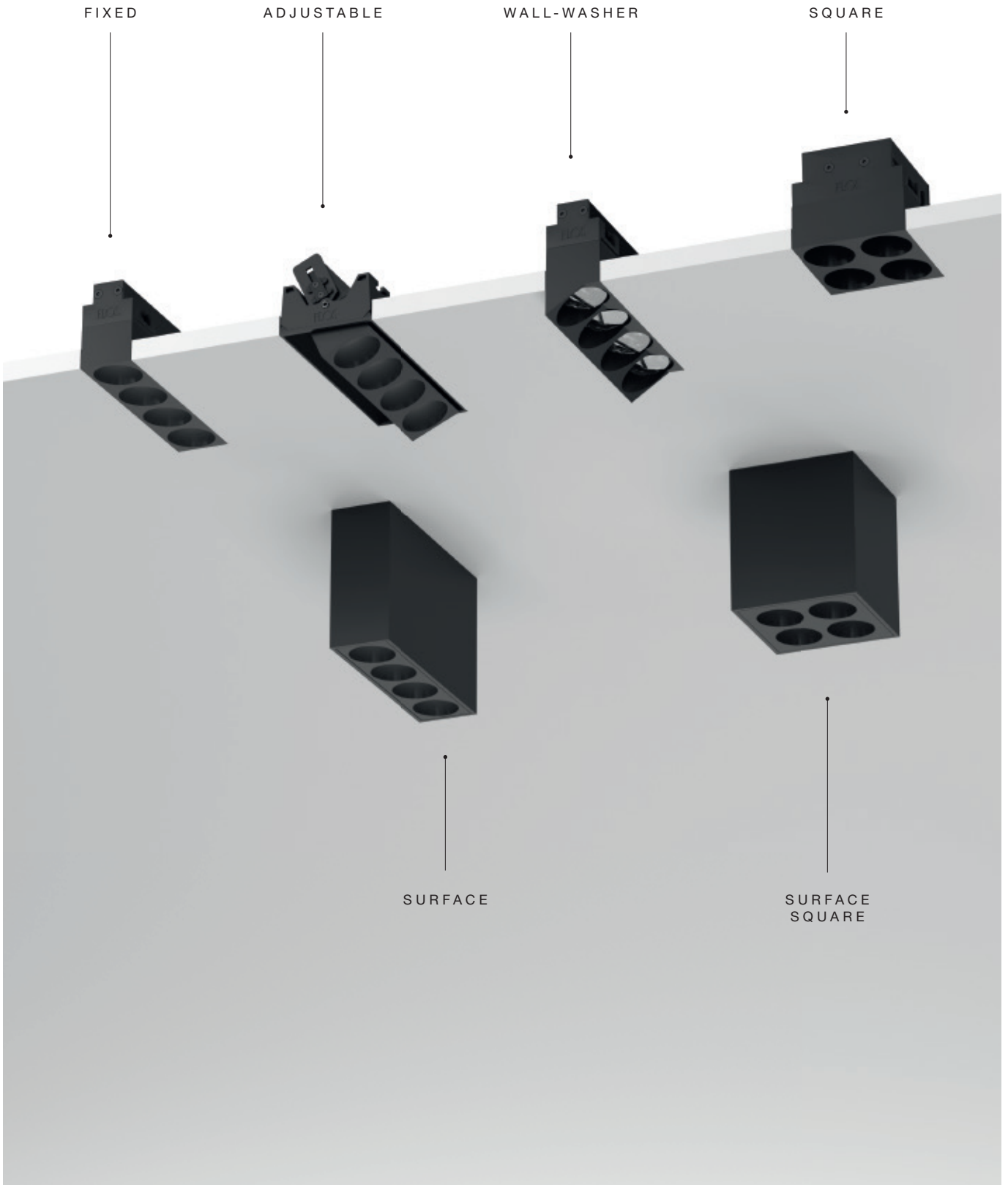

LIGHT SHADOW

Light Shadow Fixed Trim 2 Spots

Light Source: Power LED DC 900 mA 5,4W - 540 lm - 2700K/CRI 90 / 5,4W - 570 lm - 3000K/CRI 90

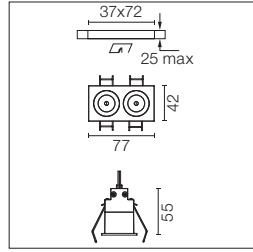

- GWT 850°
- IP 55
- 0,25 Kg
- 03
- F
- h=150 min
- TECEE
- 10 - 100%
- CE
- DALI
- LED INCL

Leuchte für Unterputzmontage mit 2 LED-Lichtquellen. Externes Netzgerät eingeschlossen (220-240V). Vorinstallationsrahmen nicht erforderlich.

Recessed integrated luminaire with 2 LED lighting spots. Remote power supply included (220-240V). Pre-installation frame not required.

E= Außenfarbe
I= Innenfarbe

E= External Finish
I= Internal Finish

Optic Spot 2700K

- | | |
|--|---------------|
| | Non Dimmable |
| | 03.8820.40A |
| | 03.8820.14A |
| | Dali Version |
| | 03.8820.40ADA |
| | 03.8820.14ADA |
| | Mains Dimming |
| | 03.8820.40ANI |
| | 03.8820.14ANI |
| | Casambi |
| | 03.8820.40ACB |
| | 03.8820.14ACB |
| | Non Dimmable |
| | 03.8821.40A |
| | 03.8821.14A |
| | Dali Version |
| | 03.8821.40ADA |
| | 03.8821.14ADA |
| | Mains Dimming |
| | 03.8821.40ANI |
| | 03.8821.14ANI |
| | Casambi |
| | 03.8821.40ACB |
| | 03.8821.14ACB |
| | Non Dimmable |
| | 05.1000.40A |
| | 05.1000.14A |
| | Dali Version |
| | 05.1000.40ADA |
| | 05.1000.14ADA |
| | Mains Dimming |
| | 05.1000.40ANI |
| | 05.1000.14ANI |
| | Casambi |
| | 05.1000.40ACB |
| | 05.1000.14ACB |
| | Non Dimmable |
| | 05.1001.40A |
| | 05.1001.14A |
| | Dali Version |
| | 05.1001.40ADA |
| | 05.1001.14ADA |
| | Mains Dimming |
| | 05.1001.40ANI |
| | 05.1001.14ANI |
| | Casambi |
| | 05.1001.40ACB |
| | 05.1001.14ACB |
| | Non Dimmable |
| | 05.1002.40A |
| | 05.1002.14A |
| | Dali Version |
| | 05.1002.40ADA |
| | 05.1002.14ADA |
| | Mains Dimming |
| | 05.1002.40ANI |
| | 05.1002.14ANI |
| | Casambi |
| | 05.1002.40ACB |
| | 05.1002.14ACB |

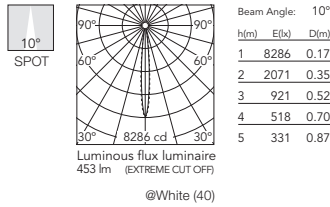





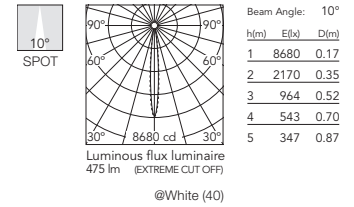

























Optic Spot 3000K

- | | |
|--|---------------|
| | Non Dimmable |
| | 03.8824.40A |
| | 03.8824.14A |
| | Dali Version |
| | 03.8824.40ADA |
| | 03.8824.14ADA |
| | Mains Dimming |
| | 03.8824.40ANI |
| | 03.8824.14ANI |
| | Casambi |
| | 03.8824.40ACB |
| | 03.8824.14ACB |
| | Non Dimmable |
| | 03.8825.40A |
| | 03.8825.14A |
| | Dali Version |
| | 03.8825.40ADA |
| | 03.8825.14ADA |
| | Mains Dimming |
| | 03.8825.40ANI |
| | 03.8825.14ANI |
| | Casambi |
| | 03.8825.40ACB |
| | 03.8825.14ACB |
| | Non Dimmable |
| | 05.1005.40A |
| | 05.1005.14A |
| | Dali Version |
| | 05.1005.40ADA |
| | 05.1005.14ADA |
| | Mains Dimming |
| | 05.1005.40ANI |
| | 05.1005.14ANI |
| | Casambi |
| | 05.1005.40ACB |
| | 05.1005.14ACB |
| | Non Dimmable |
| | 05.1006.40A |
| | 05.1006.14A |
| | Dali Version |
| | 05.1006.40ADA |
| | 05.1006.14ADA |
| | Mains Dimming |
| | 05.1006.40ANI |
| | 05.1006.14ANI |
| | Casambi |
| | 05.1006.40ACB |
| | 05.1006.14ACB |
| | Non Dimmable |
| | 05.1007.40A |
| | 05.1007.14A |
| | Dali Version |
| | 05.1007.40ADA |
| | 05.1007.14ADA |
| | Mains Dimming |
| | 05.1007.40ANI |
| | 05.1007.14ANI |
| | Casambi |
| | 05.1007.40ACB |
| | 05.1007.14ACB |







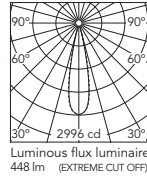

























Optic Medium 2700K

- | | |
|--|---------------|
|  | Non Dimmable |
|  | 03.9100.40A |
|  | 03.9100.14A |
| | Dali Version |
|  | 03.9100.40ADA |
|  | 03.9100.14ADA |
| | Mains Dimming |
|  | 03.9100.40ANI |
|  | 03.9100.14ANI |
| | Casambi |
|  | 03.9100.40ACB |
|  | 03.9100.14ACB |
| | Non Dimmable |
|  | 03.9101.40A |
|  | 03.9101.14A |
| | Dali Version |
|  | 03.9101.40ADA |
|  | 03.9101.14ADA |
| | Mains Dimming |
|  | 03.9101.40ANI |
|  | 03.9101.14ANI |
| | Casambi |
|  | 03.9101.40ACB |
|  | 03.9101.14ACB |
| | Non Dimmable |
|  | 05.1010.40A |
|  | 05.1010.14A |
| | Dali Version |
|  | 05.1010.40ADA |
|  | 05.1010.14ADA |
| | Mains Dimming |
|  | 05.1010.40ANI |
|  | 05.1010.14ANI |
| | Casambi |
|  | 05.1010.40ACB |
|  | 05.1010.14ACB |
| | Non Dimmable |
|  | 05.1011.40A |
|  | 05.1011.14A |
| | Dali Version |
|  | 05.1011.40ADA |
|  | 05.1011.14ADA |
| | Mains Dimming |
|  | 05.1011.40ANI |
|  | 05.1011.14ANI |
| | Casambi |
| | 05.1011.40ACB |
| | 05.1011.14ACB |
| | Non Dimmable |
| | 05.1012.40A |
| | 05.1012.14A |
| | Dali Version |
| | 05.1012.40ADA |
| | 05.1012.14ADA |
| | Mains Dimming |
| | 05.1012.40ANI |
| | 05.1012.14ANI |
| | Casambi |
| | 05.1012.40ACB |
| | 05.1012.14ACB |



h(m)	E(flx)	D(m)
1	2996	0.39
2	749	0.78
3	333	1.17
4	187	1.56
5	120	1.95

Optic Medium 3000K

- | | |
|---|---------------|
|  | Non Dimmable |
|  | 03.9110.40A |
|  | 03.9110.14A |
| | Dali Version |
|  | 03.9110.40ADA |
|  | 03.9110.14ADA |
| | Mains Dimming |
|  | 03.9110.40ANI |
|  | 03.9110.14ANI |
| | Casambi |
|  | 03.9110.40ACB |
|  | 03.9110.14ACB |
| | Non Dimmable |
|  | 03.9111.40A |
|  | 03.9111.14A |
| | Dali Version |
|  | 03.9111.40ADA |
|  | 03.9111.14ADA |
| | Mains Dimming |
|  | 03.9111.40ANI |
|  | 03.9111.14ANI |
| | Casambi |
|  | 03.9111.40ACB |
|  | 03.9111.14ACB |
| | Non Dimmable |
|  | 05.1015.40A |
|  | 05.1015.14A |
| | Dali Version |
|  | 05.1015.40ADA |
|  | 05.1015.14ADA |
| | Mains Dimming |
|  | 05.1015.40ANI |
|  | 05.1015.14ANI |
| | Casambi |
|  | 05.1015.40ACB |
|  | 05.1015.14ACB |
| | Non Dimmable |
|  | 05.1016.40A |
|  | 05.1016.14A |
| | Dali Version |
|  | 05.1016.40ADA |
|  | 05.1016.14ADA |
| | Mains Dimming |
|  | 05.1016.40ANI |
|  | 05.1016.14ANI |
| | Casambi |
| | 05.1016.40ACB |
| | 05.1016.14ACB |
| | Non Dimmable |
| | 05.1017.40A |
| | 05.1017.14A |
| | Dali Version |
| | 05.1017.40ADA |
| | 05.1017.14ADA |
| | Mains Dimming |
| | 05.1017.40ANI |
| | 05.1017.14ANI |
| | Casambi |
| | 05.1017.40ACB |
| | 05.1017.14ACB |

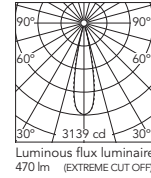

h(m)	E(flx)	D(m)
1	3139	0.39
2	785	0.78
3	349	1.17
4	196	1.56
5	126	1.95

LIGHT SHADOW

Light Shadow Fixed Trim 2 Spots

Light Source: Power LED DC 900 mA 5,4W - 540 lm - 2700K/CRI 90 / 5,4W - 570 lm - 3000K/CRI 90

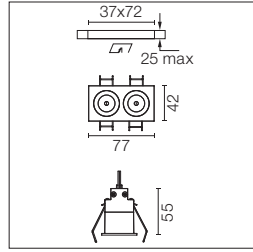

- GWT 850°
- IP 55
- 0,25 Kg
- DALI
- TECEE
- 10 - 100%
- h=150 min
- DALI
- CE
- LED INCL

Leuchte für Unterputzmontage mit 2 LED-Lichtquellen. Externes Netzgerät eingeschlossen (220-240V). Vorinstallationsrahmen nicht erforderlich.

E= Außenfarbe
I= Innenfarbe

Recessed integrated luminaire with 2 LED lighting spots. Remote power supply included (220-240V). Pre-installation frame not required.

E= External Finish
I= Internal Finish

Optic Flood 2700K

- | | |
|--|---------------|
| | Non Dimmable |
| | 03.9105.40A |
| | 03.9105.14A |
| | Dali Version |
| | 03.9105.40ADA |
| | 03.9105.14ADA |
| | Mains Dimming |
| | 03.9105.40ANI |
| | 03.9105.14ANI |
| | Casambi |
| | 03.9105.40ACB |
| | 03.9105.14ACB |
| | Non Dimmable |
| | 03.9106.40A |
| | 03.9106.14A |
| | Dali Version |
| | 03.9106.40ADA |
| | 03.9106.14ADA |
| | Mains Dimming |
| | 03.9106.40ANI |
| | 03.9106.14ANI |
| | Casambi |
| | 03.9106.40ACB |
| | 03.9106.14ACB |
| | Non Dimmable |
| | 05.1020.40A |
| | 05.1020.14A |
| | Dali Version |
| | 05.1020.40ADA |
| | 05.1020.14ADA |
| | Mains Dimming |
| | 05.1020.40ANI |
| | 05.1020.14ANI |
| | Casambi |
| | 05.1020.40ACB |
| | 05.1020.14ACB |
| | Non Dimmable |
| | 05.1021.40A |
| | 05.1021.14A |
| | Dali Version |
| | 05.1021.40ADA |
| | 05.1021.14ADA |
| | Mains Dimming |
| | 05.1021.40ANI |
| | 05.1021.14ANI |
| | Casambi |
| | 05.1021.40ACB |
| | 05.1021.14ACB |
| | Non Dimmable |
| | 05.1022.40A |
| | 05.1022.14A |
| | Dali Version |
| | 05.1022.40ADA |
| | 05.1022.14ADA |
| | Mains Dimming |
| | 05.1022.40ANI |
| | 05.1022.14ANI |
| | Casambi |
| | 05.1022.40ACB |
| | 05.1022.14ACB |

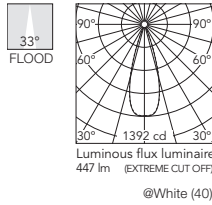





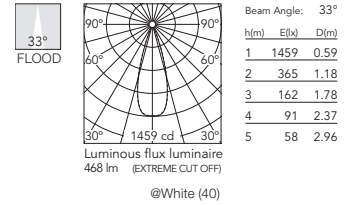















Optic Flood 3000K

- | | |
|--|---------------|
| | Non Dimmable |
| | 03.9115.40A |
| | 03.9115.14A |
| | Dali Version |
| | 03.9115.40ADA |
| | 03.9115.14ADA |
| | Mains Dimming |
| | 03.9115.40ANI |
| | 03.9115.14ANI |
| | Casambi |
| | 03.9115.40ACB |
| | 03.9115.14ACB |
| | Non Dimmable |
| | 03.9116.40A |
| | 03.9116.14A |
| | Dali Version |
| | 03.9116.40ADA |
| | 03.9116.14ADA |
| | Mains Dimming |
| | 03.9116.40ANI |
| | 03.9116.14ANI |
| | Casambi |
| | 03.9116.40ACB |
| | 03.9116.14ACB |
| | Non Dimmable |
| | 05.1025.40A |
| | 05.1025.14A |
| | Dali Version |
| | 05.1025.40ADA |
| | 05.1025.14ADA |
| | Mains Dimming |
| | 05.1025.40ANI |
| | 05.1025.14ANI |
| | Casambi |
| | 05.1025.40ACB |
| | 05.1025.14ACB |
| | Non Dimmable |
| | 05.1026.40A |
| | 05.1026.14A |
| | Dali Version |
| | 05.1026.40ADA |
| | 05.1026.14ADA |
| | Mains Dimming |
| | 05.1026.40ANI |
| | 05.1026.14ANI |
| | Casambi |
| | 05.1026.40ACB |
| | 05.1026.14ACB |
| | Non Dimmable |
| | 05.1027.40A |
| | 05.1027.14A |
| | Dali Version |
| | 05.1027.40ADA |
| | 05.1027.14ADA |
| | Mains Dimming |
| | 05.1027.40ANI |
| | 05.1027.14ANI |
| | Casambi |
| | 05.1027.40ACB |
| | 05.1027.14ACB |



Optic Wide Flood 2700K

-  Non Dimmable
03.8300.40A
03.8300.14A
Dali Version
-  03.8300.40ADA
03.8300.14ADA
Mains Dimming
-  03.8300.40ANI
03.8300.14ANI
Casambi
-  03.8300.40ACB
03.8300.14ACB
Non Dimmable
-  03.8301.40A
03.8301.14A
Dali Version
-  03.8301.40ADA
03.8301.14ADA
Mains Dimming
-  03.8301.40ANI
03.8301.14ANI
Casambi
-  03.8301.40ACB
03.8301.14ACB
Non Dimmable
-  05.1030.40A
05.1030.14A
Dali Version
-  05.1030.40ADA
05.1030.14ADA
Mains Dimming
-  05.1030.40ANI
05.1030.14ANI
Casambi
-  05.1030.40ACB
05.1030.14ACB
Non Dimmable
-  05.1031.40A
05.1031.14A
Dali Version
-  05.1031.40ADA
05.1031.14ADA
Mains Dimming
-  05.1031.40ANI
05.1031.14ANI
Casambi
-  05.1031.40ACB
05.1031.14ACB
Non Dimmable
-  05.1032.40A
05.1032.14A
Dali Version
-  05.1032.40ADA
05.1032.14ADA
Mains Dimming
-  05.1032.40ANI
05.1032.14ANI
Casambi
-  05.1032.40ACB
05.1032.14ACB

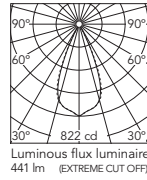





















Beam Angle: 45°

h(m)	E(lx)	D(m)
1	822	0.83
2	205	1.67
3	91	2.50
4	51	3.34
5	33	4.17

@White (40)

Optic Wide Flood 3000K

-  Non Dimmable
03.8304.40A
03.8304.14A
Dali Version
-  03.8304.40ADA
03.8304.14ADA
Mains Dimming
-  03.8304.40ANI
03.8304.14ANI
Casambi
-  03.8304.40ACB
03.8304.14ACB
Non Dimmable
-  03.8305.40A
03.8305.14A
Dali Version
-  03.8305.40ADA
03.8305.14ADA
Mains Dimming
-  03.8305.40ANI
03.8305.14ANI
Casambi
-  03.8305.40ACB
03.8305.14ACB
Non Dimmable
-  05.1035.40A
05.1035.14A
Dali Version
-  05.1035.40ADA
05.1035.14ADA
Mains Dimming
-  05.1035.40ANI
05.1035.14ANI
Casambi
-  05.1035.40ACB
05.1035.14ACB
Non Dimmable
-  05.1036.40A
05.1036.14A
Dali Version
-  05.1036.40ADA
05.1036.14ADA
Mains Dimming
-  05.1036.40ANI
05.1036.14ANI
Casambi
-  05.1036.40ACB
05.1036.14ACB
Non Dimmable
-  05.1037.40A
05.1037.14A
Dali Version
-  05.1037.40ADA
05.1037.14ADA
Mains Dimming
-  05.1037.40ANI
05.1037.14ANI
Casambi
-  05.1037.40ACB
05.1037.14ACB

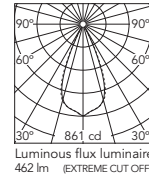

Beam Angle: 45°

h(m)	E(lx)	D(m)
1	861	0.83
2	215	1.67
3	96	2.50
4	54	3.34
5	34	4.17

@White (40)

Light Shadow Fixed Trim 4 Spots

Light Source: Power LED DC 900 mA 10,8W - 1080 lm - 2700K/CRI 90 / 10,8W - 1140 lm - 3000K/CRI 90

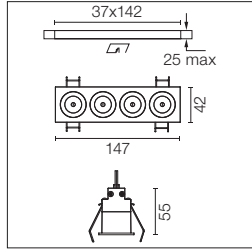

- GWT 850°
- IP 55
- 0,34 Kg
- DALI
- h=75 min
- CE
- TECEE
- 10 - 100%
- LED INCL

Leuchte für Unterputzmontage mit 4 LED-Lichtquellen. Externes Netzgerät eingeschlossen (220-240V).
Vorinstallationsrahmen nicht erforderlich.

Recessed integrated luminaire with 4 LED lighting spots. Remote power supply included (220-240V).
Pre-installation frame not required.

E= Außenfarbe
I= Innenfarbe

E= External Finish
I= Internal Finish

Optic Spot 2700K

- | | |
|--|---------------|
| | Non Dimmable |
| | 03.8828.40A |
| | 03.8828.14A |
| | Dali Version |
| | 03.8828.40ADA |
| | 03.8828.14ADA |
| | Mains Dimming |
| | 03.8828.40ANI |
| | 03.8828.14ANI |
| | Casambi |
| | 03.8828.40ACB |
| | 03.8828.14ACB |
| | Non Dimmable |
| | 03.8829.40A |
| | 03.8829.14A |
| | Dali Version |
| | 03.8829.40ADA |
| | 03.8829.14ADA |
| | Mains Dimming |
| | 03.8829.40ANI |
| | 03.8829.14ANI |
| | Casambi |
| | 03.8829.40ACB |
| | 03.8829.14ACB |
| | Non Dimmable |
| | 05.1100.40A |
| | 05.1100.14A |
| | Dali Version |
| | 05.1100.40ADA |
| | 05.1100.14ADA |
| | Mains Dimming |
| | 05.1100.40ANI |
| | 05.1100.14ANI |
| | Casambi |
| | 05.1100.40ACB |
| | 05.1100.14ACB |
| | Non Dimmable |
| | 05.1101.40A |
| | 05.1101.14A |
| | Dali Version |
| | 05.1101.40ADA |
| | 05.1101.14ADA |
| | Mains Dimming |
| | 05.1101.40ANI |
| | 05.1101.14ANI |
| | Casambi |
| | 05.1101.40ACB |
| | 05.1101.14ACB |
| | Non Dimmable |
| | 05.1102.40A |
| | 05.1102.14A |
| | Dali Version |
| | 05.1102.40ADA |
| | 05.1102.14ADA |
| | Mains Dimming |
| | 05.1102.40ANI |
| | 05.1102.14ANI |
| | Casambi |
| | 05.1102.40ACB |
| | 05.1102.14ACB |

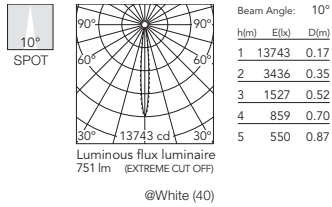





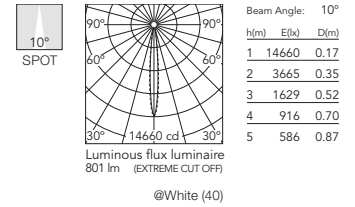















Optic Spot 3000K

- | | |
|--|---------------|
| | Non Dimmable |
| | 03.8832.40A |
| | 03.8832.14A |
| | Dali Version |
| | 03.8832.40ADA |
| | 03.8832.14ADA |
| | Mains Dimming |
| | 03.8832.40ANI |
| | 03.8832.14ANI |
| | Casambi |
| | 03.8832.40ACB |
| | 03.8832.14ACB |
| | Non Dimmable |
| | 03.8833.40A |
| | 03.8833.14A |
| | Dali Version |
| | 03.8833.40ADA |
| | 03.8833.14ADA |
| | Mains Dimming |
| | 03.8833.40ANI |
| | 03.8833.14ANI |
| | Casambi |
| | 03.8833.40ACB |
| | 03.8833.14ACB |
| | Non Dimmable |
| | 05.1105.40A |
| | 05.1105.14A |
| | Dali Version |
| | 05.1105.40ADA |
| | 05.1105.14ADA |
| | Mains Dimming |
| | 05.1105.40ANI |
| | 05.1105.14ANI |
| | Casambi |
| | 05.1105.40ACB |
| | 05.1105.14ACB |
| | Non Dimmable |
| | 05.1106.40A |
| | 05.1106.14A |
| | Dali Version |
| | 05.1106.40ADA |
| | 05.1106.14ADA |
| | Mains Dimming |
| | 05.1106.40ANI |
| | 05.1106.14ANI |
| | Casambi |
| | 05.1106.40ACB |
| | 05.1106.14ACB |
| | Non Dimmable |
| | 05.1107.40A |
| | 05.1107.14A |
| | Dali Version |
| | 05.1107.40ADA |
| | 05.1107.14ADA |
| | Mains Dimming |
| | 05.1107.40ANI |
| | 05.1107.14ANI |
| | Casambi |
| | 05.1107.40ACB |
| | 05.1107.14ACB |



**Optic Medium
2700K**

-  Non Dimmable
03.9120.40A
03.9120.14A
Dali Version
-  03.9120.40ADA
03.9120.14ADA
Mains Dimming
-  03.9120.40ANI
03.9120.14ANI
Casambi
-  03.9120.40ACB
03.9120.14ACB
Non Dimmable
-  03.9121.40A
03.9121.14A
Dali Version
-  03.9121.40ADA
03.9121.14ADA
Mains Dimming
-  03.9121.40ANI
03.9121.14ANI
Casambi
-  03.9121.40ACB
03.9121.14ACB
Non Dimmable
-  05.1110.40A
05.1110.14A
Dali Version
-  05.1110.40ADA
05.1110.14ADA
Mains Dimming
-  05.1110.40ANI
05.1110.14ANI
Casambi
-  05.1110.40ACB
05.1110.14ACB
Non Dimmable
-  05.1111.40A
05.1111.14A
Dali Version
-  05.1111.40ADA
05.1111.14ADA
Mains Dimming
-  05.1111.40ANI
05.1111.14ANI
Casambi
-  05.1111.40ACB
05.1111.14ACB
Non Dimmable
-  05.1112.40A
05.1112.14A
Dali Version
-  05.1112.40ADA
05.1112.14ADA
Mains Dimming
-  05.1112.40ANI
05.1112.14ANI
Casambi
-  05.1112.40ACB
05.1112.14ACB

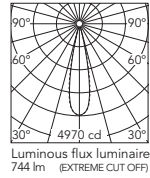





















Beam Angle: 22°

h(m)	E(lx)	D(m)
1	4970	0.39
2	1243	0.78
3	552	1.17
4	311	1.56
5	199	1.95

@White (40)

**Optic Medium
3000K**

-  Non Dimmable
03.9130.40A
03.9130.14A
Dali Version
-  03.9130.40ADA
03.9130.14ADA
Mains Dimming
-  03.9130.40ANI
03.9130.14ANI
Casambi
-  03.9130.40ACB
03.9130.14ACB
Non Dimmable
-  03.9131.40A
03.9131.14A
Dali Version
-  03.9131.40ADA
03.9131.14ADA
Mains Dimming
-  03.9131.40ANI
03.9131.14ANI
Casambi
-  03.9131.40ACB
03.9131.14ACB
Non Dimmable
-  05.1115.40A
05.1115.14A
Dali Version
-  05.1115.40ADA
05.1115.14ADA
Mains Dimming
-  05.1115.40ANI
05.1115.14ANI
Casambi
-  05.1115.40ACB
05.1115.14ACB
Non Dimmable
-  05.1116.40A
05.1116.14A
Dali Version
-  05.1116.40ADA
05.1116.14ADA
Mains Dimming
-  05.1116.40ANI
05.1116.14ANI
Casambi
-  05.1116.40ACB
05.1116.14ACB
Non Dimmable
-  05.1117.40A
05.1117.14A
Dali Version
-  05.1117.40ADA
05.1117.14ADA
Mains Dimming
-  05.1117.40ANI
05.1117.14ANI
Casambi
-  05.1117.40ACB
05.1117.14ACB

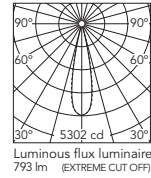

Beam Angle: 22°

h(m)	E(lx)	D(m)
1	5302	0.39
2	1325	0.78
3	589	1.17
4	331	1.56
5	212	1.95

@White (40)

LIGHT SHADOW

Light Shadow Fixed Trim 4 Spots

Light Source: Power LED DC 900 mA 10,8W - 1080 lm - 2700K/CRI 90 / 10,8W - 1140 lm - 3000K/CRI 90

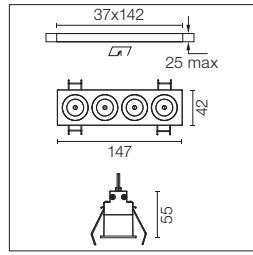

- GWT 850°
- IP 55
- 0.34 Kg
- 03
- F
- h=75 min
- TECEE
- 10 - 100%
- CE
- DALI
- LED INCL

Leuchte für Unterputzmontage mit 4 LED-Lichtquellen. Externes Netzgerät eingeschlossen (220-240V). Vorinstallationsrahmen nicht erforderlich.

Recessed integrated luminaire with 4 LED lighting spots. Remote power supply included (220-240V). Pre-installation frame not required.

E= Außenfarbe
I= Innenfarbe

E= External Finish
I= Internal Finish

Optic Flood 2700K

- | | |
|--|---------------|
| | Non Dimmable |
| | 03.9125.40A |
| | 03.9125.14A |
| | Dali Version |
| | 03.9125.40ADA |
| | 03.9125.14ADA |
| | Mains Dimming |
| | 03.9125.40ANI |
| | 03.9125.14ANI |
| | Casambi |
| | 03.9125.40ACB |
| | 03.9125.14ACB |
| | Non Dimmable |
| | 03.9126.40A |
| | 03.9126.14A |
| | Dali Version |
| | 03.9126.40ADA |
| | 03.9126.14ADA |
| | Mains Dimming |
| | 03.9126.40ANI |
| | 03.9126.14ANI |
| | Casambi |
| | 03.9126.40ACB |
| | 03.9126.14ACB |
| | Non Dimmable |
| | 05.1120.40A |
| | 05.1120.14A |
| | Dali Version |
| | 05.1120.40ADA |
| | 05.1120.14ADA |
| | Mains Dimming |
| | 05.1120.40ANI |
| | 05.1120.14ANI |
| | Casambi |
| | 05.1120.40ACB |
| | 05.1120.14ACB |
| | Non Dimmable |
| | 05.1121.40A |
| | 05.1121.14A |
| | Dali Version |
| | 05.1121.40ADA |
| | 05.1121.14ADA |
| | Mains Dimming |
| | 05.1121.40ANI |
| | 05.1121.14ANI |
| | Casambi |
| | 05.1121.40ACB |
| | 05.1121.14ACB |
| | Non Dimmable |
| | 05.1122.40A |
| | 05.1122.14A |
| | Dali Version |
| | 05.1122.40ADA |
| | 05.1122.14ADA |
| | Mains Dimming |
| | 05.1122.40ANI |
| | 05.1122.14ANI |
| | Casambi |
| | 05.1122.40ACB |
| | 05.1122.14ACB |

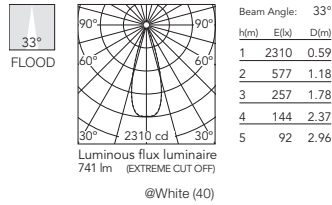





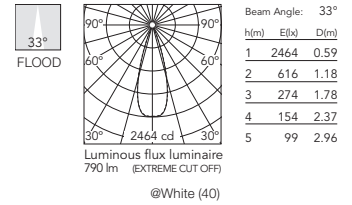



































Optic Flood 3000K

- | | |
|--|---------------|
| | Non Dimmable |
| | 03.9135.40A |
| | 03.9135.14A |
| | Dali Version |
| | 03.9135.40ADA |
| | 03.9135.14ADA |
| | Mains Dimming |
| | 03.9135.40ANI |
| | 03.9135.14ANI |
| | Casambi |
| | 03.9135.40ACB |
| | 03.9135.14ACB |
| | Non Dimmable |
| | 03.9136.40A |
| | 03.9136.14A |
| | Dali Version |
| | 03.9136.40ADA |
| | 03.9136.14ADA |
| | Mains Dimming |
| | 03.9136.40ANI |
| | 03.9136.14ANI |
| | Casambi |
| | 03.9136.40ACB |
| | 03.9136.14ACB |
| | Non Dimmable |
| | 05.1125.40A |
| | 05.1125.14A |
| | Dali Version |
| | 05.1125.40ADA |
| | 05.1125.14ADA |
| | Mains Dimming |
| | 05.1125.40ANI |
| | 05.1125.14ANI |
| | Casambi |
| | 05.1125.40ACB |
| | 05.1125.14ACB |
| | Non Dimmable |
| | 05.1126.40A |
| | 05.1126.14A |
| | Dali Version |
| | 05.1126.40ADA |
| | 05.1126.14ADA |
| | Mains Dimming |
| | 05.1126.40ANI |
| | 05.1126.14ANI |
| | Casambi |
| | 05.1126.40ACB |
| | 05.1126.14ACB |
| | Non Dimmable |
| | 05.1127.40A |
| | 05.1127.14A |
| | Dali Version |
| | 05.1127.40ADA |
| | 05.1127.14ADA |
| | Mains Dimming |
| | 05.1127.40ANI |
| | 05.1127.14ANI |
| | Casambi |
| | 05.1127.40ACB |
| | 05.1127.14ACB |



**Optic Wide Flood
2700K**

- | | |
|--|---------------|
|  | Non Dimmable |
|  | 03.8308.40A |
|  | 03.8308.14A |
| | Dali Version |
|  | 03.8308.40ADA |
|  | 03.8308.14ADA |
| | Mains Dimming |
|  | 03.8308.40ANI |
|  | 03.8308.14ANI |
| | Casambi |
|  | 03.8308.40ACB |
|  | 03.8308.14ACB |
| | Non Dimmable |
|  | 03.8309.40A |
|  | 03.8309.14A |
| | Dali Version |
|  | 03.8309.40ADA |
|  | 03.8309.14ADA |
| | Mains Dimming |
|  | 03.8309.40ANI |
|  | 03.8309.14ANI |
| | Casambi |
|  | 03.8309.40ACB |
|  | 03.8309.14ACB |
| | Non Dimmable |
|  | 05.1130.40A |
|  | 05.1130.14A |
| | Dali Version |
|  | 05.1130.40ADA |
|  | 05.1130.14ADA |
| | Mains Dimming |
|  | 05.1130.40ANI |
|  | 05.1130.14ANI |
| | Casambi |
|  | 05.1130.40ACB |
|  | 05.1130.14ACB |
| | Non Dimmable |
|  | 05.1131.40A |
|  | 05.1131.14A |
| | Dali Version |
|  | 05.1131.40ADA |
|  | 05.1131.14ADA |
| | Mains Dimming |
|  | 05.1131.40ANI |
|  | 05.1131.14ANI |
| | Casambi |
|  | 05.1131.40ACB |
|  | 05.1131.14ACB |
| | Non Dimmable |
|  | 05.1132.40A |
|  | 05.1132.14A |
| | Dali Version |
|  | 05.1132.40ADA |
|  | 05.1132.14ADA |
| | Mains Dimming |
|  | 05.1132.40ANI |
|  | 05.1132.14ANI |
| | Casambi |
|  | 05.1132.40ACB |
|  | 05.1132.14ACB |

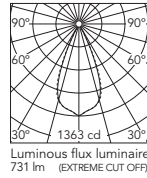









































Beam Angle: 45°

h(m)	E(lx)	D(m)
1	1363	0.83
2	341	1.67
3	151	2.50
4	85	3.34
5	55	4.17

@White (40)

**Optic Wide Flood
3000K**

- | | |
|---|---------------|
|  | Non Dimmable |
|  | 03.8312.40A |
|  | 03.8312.14A |
| | Dali Version |
|  | 03.8312.40ADA |
|  | 03.8312.14ADA |
| | Mains Dimming |
|  | 03.8312.40ANI |
|  | 03.8312.14ANI |
| | Casambi |
|  | 03.8312.40ACB |
|  | 03.8312.14ACB |
| | Non Dimmable |
|  | 03.8313.40A |
|  | 03.8313.14A |
| | Dali Version |
|  | 03.8313.40ADA |
|  | 03.8313.14ADA |
| | Mains Dimming |
|  | 03.8313.40ANI |
|  | 03.8313.14ANI |
| | Casambi |
|  | 03.8313.40ACB |
|  | 03.8313.14ACB |
| | Non Dimmable |
|  | 05.1135.40A |
|  | 05.1135.14A |
| | Dali Version |
|  | 05.1135.40ADA |
|  | 05.1135.14ADA |
| | Mains Dimming |
|  | 05.1135.40ANI |
|  | 05.1135.14ANI |
| | Casambi |
|  | 05.1135.40ACB |
|  | 05.1135.14ACB |
| | Non Dimmable |
|  | 05.1136.40A |
|  | 05.1136.14A |
| | Dali Version |
|  | 05.1136.40ADA |
|  | 05.1136.14ADA |
| | Mains Dimming |
|  | 05.1136.40ANI |
|  | 05.1136.14ANI |
| | Casambi |
|  | 05.1136.40ACB |
|  | 05.1136.14ACB |
| | Non Dimmable |
|  | 05.1137.40A |
|  | 05.1137.14A |
| | Dali Version |
|  | 05.1137.40ADA |
|  | 05.1137.14ADA |
| | Mains Dimming |
|  | 05.1137.40ANI |
|  | 05.1137.14ANI |
| | Casambi |
|  | 05.1137.40ACB |
|  | 05.1137.14ACB |

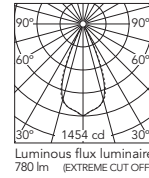

Beam Angle: 45°

h(m)	E(lx)	D(m)
1	1454	0.83
2	363	1.67
3	162	2.50
4	91	3.34
5	58	4.17

@White (40)

LIGHT SHADOW

Light Shadow Fixed Trim 4 Spots Square

Light Source: Power LED DC 900 mA 10,8W - 1080 lm - 2700K/CRI 90 / 10,8W - 1140 lm - 3000K/CRI 90

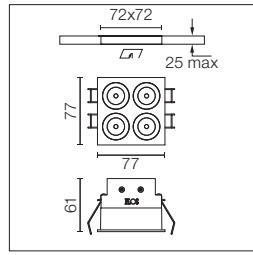

GWT 850°



0,34 Kg

10 - 100%



h=75 min

DALI



CE

IP 55

Leuchte für Unterputzmontage mit 4 LED-Lichtquellen. Externes Netzgerät eingeschlossen (220-240V). Vorinstallationsrahmen nicht erforderlich.

E= Außenfarbe
I= Innenfarbe

Recessed integrated luminaire with 4 LED lighting spots. Remote power supply included (220-240V). Pre-installation frame not required.

E= External Finish
I= Internal Finish

Optic Spot 2700K

- | | |
|-----|---------------|
| E I | Non Dimmable |
| ■ ■ | 05.0600.40 |
| ■ ■ | 05.0600.14 |
| | Dali Version |
| ■ ■ | 05.0600.40.DA |
| ■ ■ | 05.0600.14.DA |
| | Mains Dimming |
| ■ ■ | 05.0600.40.NI |
| ■ ■ | 05.0600.14.NI |
| | Casambi |
| ■ ■ | 05.0600.40.CB |
| ■ ■ | 05.0600.14.CB |
| | Non Dimmable |
| ■ ■ | 05.0601.40 |
| ■ ■ | 05.0601.14 |
| | Dali Version |
| ■ ■ | 05.0601.40.DA |
| ■ ■ | 05.0601.14.DA |
| | Mains Dimming |
| ■ ■ | 05.0601.40.NI |
| ■ ■ | 05.0601.14.NI |
| | Casambi |
| ■ ■ | 05.0601.40.CB |
| ■ ■ | 05.0601.14.CB |
| | Non Dimmable |
| ■ ■ | 05.0603.40 |
| ■ ■ | 05.0603.14 |
| | Dali Version |
| ■ ■ | 05.0603.40.DA |
| ■ ■ | 05.0603.14.DA |
| | Mains Dimming |
| ■ ■ | 05.0603.40.NI |
| ■ ■ | 05.0603.14.NI |
| | Casambi |
| ■ ■ | 05.0603.40.CB |
| ■ ■ | 05.0603.14.CB |
| | Non Dimmable |
| ■ ■ | 05.0604.40 |
| ■ ■ | 05.0604.14 |
| | Dali Version |
| ■ ■ | 05.0604.40.DA |
| ■ ■ | 05.0604.14.DA |
| | Mains Dimming |
| ■ ■ | 05.0604.40.NI |
| ■ ■ | 05.0604.14.NI |
| | Casambi |
| ■ ■ | 05.0604.40.CB |
| ■ ■ | 05.0604.14.CB |
| | Non Dimmable |
| ■ ■ | 05.0602.40 |
| ■ ■ | 05.0602.14 |
| | Dali Version |
| ■ ■ | 05.0602.40.DA |
| ■ ■ | 05.0602.14.DA |
| | Mains Dimming |
| ■ ■ | 05.0602.40.NI |
| ■ ■ | 05.0602.14.NI |
| | Casambi |
| ■ ■ | 05.0602.40.CB |
| ■ ■ | 05.0602.14.CB |

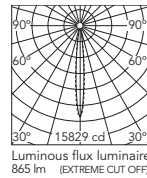

Beam Angle: 10°

h(m)	E(lx)	D(m)
1	15829	0.17
2	3957	0.35
3	1759	0.52
4	989	0.70
5	633	0.87

Luminous flux luminaire 865 lm (EXTREME CUT OFF)
@White (40)

Optic Spot 3000K

- | | |
|-----|---------------|
| E I | Non Dimmable |
| ■ ■ | 05.0605.40 |
| ■ ■ | 05.0605.14 |
| | Dali Version |
| ■ ■ | 05.0605.40.DA |
| ■ ■ | 05.0605.14.DA |
| | Mains Dimming |
| ■ ■ | 05.0605.40.NI |
| ■ ■ | 05.0605.14.NI |
| | Casambi |
| ■ ■ | 05.0605.40.CB |
| ■ ■ | 05.0605.14.CB |
| | Non Dimmable |
| ■ ■ | 05.0606.40 |
| ■ ■ | 05.0606.14 |
| | Dali Version |
| ■ ■ | 05.0606.40.DA |
| ■ ■ | 05.0606.14.DA |
| | Mains Dimming |
| ■ ■ | 05.0606.40.NI |
| ■ ■ | 05.0606.14.NI |
| | Casambi |
| ■ ■ | 05.0606.40.CB |
| ■ ■ | 05.0606.14.CB |
| | Non Dimmable |
| ■ ■ | 05.0608.40 |
| ■ ■ | 05.0608.14 |
| | Dali Version |
| ■ ■ | 05.0608.40.DA |
| ■ ■ | 05.0608.14.DA |
| | Mains Dimming |
| ■ ■ | 05.0608.40.NI |
| ■ ■ | 05.0608.14.NI |
| | Casambi |
| ■ ■ | 05.0608.40.CB |
| ■ ■ | 05.0608.14.CB |
| | Non Dimmable |
| ■ ■ | 05.0609.40 |
| ■ ■ | 05.0609.14 |
| | Dali Version |
| ■ ■ | 05.0609.40.DA |
| ■ ■ | 05.0609.14.DA |
| | Mains Dimming |
| ■ ■ | 05.0609.40.NI |
| ■ ■ | 05.0609.14.NI |
| | Casambi |
| ■ ■ | 05.0609.40.CB |
| ■ ■ | 05.0609.14.CB |
| | Non Dimmable |
| ■ ■ | 05.0607.40 |
| ■ ■ | 05.0607.14 |
| | Dali Version |
| ■ ■ | 05.0607.40.DA |
| ■ ■ | 05.0607.14.DA |
| | Mains Dimming |
| ■ ■ | 05.0607.40.NI |
| ■ ■ | 05.0607.14.NI |
| | Casambi |
| ■ ■ | 05.0607.40.CB |
| ■ ■ | 05.0607.14.CB |

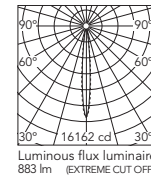









































Beam Angle: 10°

h(m)	E(lx)	D(m)
1	16162	0.17
2	4040	0.35
3	1796	0.52
4	1010	0.70
5	647	0.87







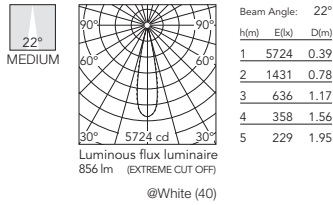

































Luminous flux luminaire 883 lm (EXTREME CUT OFF)
@White (40)

**Optic Medium
2700K**

- | | |
|--|---------------|
|  | Non Dimmable |
|  | 05.0610.40 |
|  | 05.0610.14 |
| | Dali Version |
|  | 05.0610.40.DA |
|  | 05.0610.14.DA |
| | Mains Dimming |
|  | 05.0610.40.NI |
|  | 05.0610.14.NI |
| | Casambi |
|  | 05.0610.40.CB |
|  | 05.0610.14.CB |
| | Non Dimmable |
|  | 05.0611.40 |
|  | 05.0611.14 |
| | Dali Version |
|  | 05.0611.40.DA |
|  | 05.0611.14.DA |
| | Mains Dimming |
|  | 05.0611.40.NI |
|  | 05.0611.14.NI |
| | Casambi |
|  | 05.0611.40.CB |
|  | 05.0611.14.CB |
| | Non Dimmable |
|  | 05.0613.40 |
|  | 05.0613.14 |
| | Dali Version |
|  | 05.0613.40.DA |
|  | 05.0613.14.DA |
| | Mains Dimming |
|  | 05.0613.40.NI |
|  | 05.0613.14.NI |
| | Casambi |
|  | 05.0613.40.CB |
|  | 05.0613.14.CB |
| | Non Dimmable |
|  | 05.0614.40 |
|  | 05.0614.14 |
| | Dali Version |
|  | 05.0614.40.DA |
|  | 05.0614.14.DA |
| | Mains Dimming |
|  | 05.0614.40.NI |
|  | 05.0614.14.NI |
| | Casambi |
|  | 05.0614.40.CB |
|  | 05.0614.14.CB |
| | Non Dimmable |
|  | 05.0612.40 |
|  | 05.0612.14 |
| | Dali Version |
|  | 05.0612.40.DA |
|  | 05.0612.14.DA |
| | Mains Dimming |
|  | 05.0612.40.NI |
|  | 05.0612.14.NI |
| | Casambi |
|  | 05.0612.40.CB |
|  | 05.0612.14.CB |



**Optic Medium
3000K**

- | | |
|---|---------------|
|  | Non Dimmable |
|  | 05.0615.40 |
|  | 05.0615.14 |
| | Dali Version |
|  | 05.0615.40.DA |
|  | 05.0615.14.DA |
| | Mains Dimming |
|  | 05.0615.40.NI |
|  | 05.0615.14.NI |
| | Casambi |
|  | 05.0615.40.CB |
|  | 05.0615.14.CB |
| | Non Dimmable |
|  | 05.0616.40 |
|  | 05.0616.14 |
| | Dali Version |
|  | 05.0616.40.DA |
|  | 05.0616.14.DA |
| | Mains Dimming |
|  | 05.0616.40.NI |
|  | 05.0616.14.NI |
| | Casambi |
|  | 05.0616.40.CB |
|  | 05.0616.14.CB |
| | Non Dimmable |
|  | 05.0618.40 |
|  | 05.0618.14 |
| | Dali Version |
|  | 05.0618.40.DA |
|  | 05.0618.14.DA |
| | Mains Dimming |
|  | 05.0618.40.NI |
|  | 05.0618.14.NI |
| | Casambi |
|  | 05.0618.40.CB |
|  | 05.0618.14.CB |
| | Non Dimmable |
|  | 05.0619.40 |
|  | 05.0619.14 |
| | Dali Version |
|  | 05.0619.40.DA |
|  | 05.0619.14.DA |
| | Mains Dimming |
|  | 05.0619.40.NI |
|  | 05.0619.14.NI |
| | Casambi |
|  | 05.0619.40.CB |
|  | 05.0619.14.CB |
| | Non Dimmable |
|  | 05.0617.40 |
|  | 05.0617.14 |
| | Dali Version |
|  | 05.0617.40.DA |
|  | 05.0617.14.DA |
| | Mains Dimming |
|  | 05.0617.40.NI |
|  | 05.0617.14.NI |
| | Casambi |
|  | 05.0617.40.CB |
|  | 05.0617.14.CB |

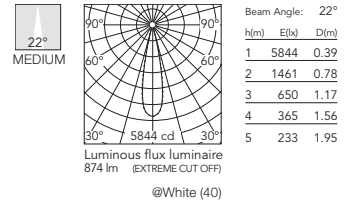

Light Shadow Fixed Trim 4 Spots Square

Light Source: Power LED DC 900 mA 10,8W - 1080 lm - 2700K/CRI 90 / 10,8W - 1140 lm - 3000K/CRI 90

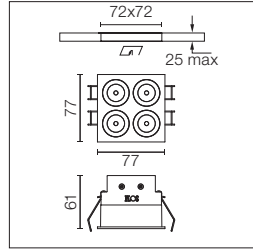

GWT 850°



Leuchte für Unterputzmontage mit 4 LED-Lichtquellen. Externes Netzgerät eingeschlossen (220-240V). Vorinstallationsrahmen nicht erforderlich.



0,34 Kg



h=75 min



LED INCL



IP 55

E= Außenfarbe
I= Innenfarbe

Recessed integrated luminaire with 4 LED lighting spots. Remote power supply included (220-240V). Pre-installation frame not required.

E= External Finish
I= Internal Finish

Optic Flood 2700K

- E I Non Dimmable
- 05.0620.40
- 05.0620.14
- Dali Version
- 05.0620.40.DA
- 05.0620.14.DA
- Mains Dimming
- 05.0620.40.NI
- 05.0620.14.NI
- Casambi
- 05.0620.40.CB
- 05.0620.14.CB
- Non Dimmable
- 05.0621.40
- 05.0621.14
- Dali Version
- 05.0621.40.DA
- 05.0621.14.DA
- Mains Dimming
- 05.0621.40.NI
- 05.0621.14.NI
- Casambi
- 05.0621.40.CB
- 05.0621.14.CB
- Non Dimmable
- 05.0623.40
- 05.0623.14
- Dali Version
- 05.0623.40.DA
- 05.0623.14.DA
- Mains Dimming
- 05.0623.40.NI
- 05.0623.14.NI
- Casambi
- 05.0623.40.CB
- 05.0623.14.CB
- Non Dimmable
- 05.0624.40
- 05.0624.14
- Dali Version
- 05.0624.40.DA
- 05.0624.14.DA
- Mains Dimming
- 05.0624.40.NI
- 05.0624.14.NI
- Casambi
- 05.0624.40.CB
- 05.0624.14.CB
- Non Dimmable
- 05.0622.40
- 05.0622.14
- Dali Version
- 05.0622.40.DA
- 05.0622.14.DA
- Mains Dimming
- 05.0622.40.NI
- 05.0622.14.NI
- Casambi
- 05.0622.40.CB
- 05.0622.14.CB

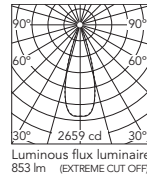

Beam Angle: 33°

h(m)	E(lx)	D(m)
1	2659	0.59
2	665	1.18
3	295	1.78
4	166	2.37
5	107	2.96

Luminous flux luminaire 853 lm (EXTREME CUT OFF)
@White (40)

Optic Flood 3000K

- E I Non Dimmable
- 05.0625.40
- 05.0625.14
- Dali Version
- 05.0625.40.DA
- 05.0625.14.DA
- Mains Dimming
- 05.0625.40.NI
- 05.0625.14.NI
- Casambi
- 05.0625.40.CB
- 05.0625.14.CB
- Non Dimmable
- 05.0626.40
- 05.0626.14
- Dali Version
- 05.0626.40.DA
- 05.0626.14.DA
- Mains Dimming
- 05.0626.40.NI
- 05.0626.14.NI
- Casambi
- 05.0626.40.CB
- 05.0626.14.CB
- Non Dimmable
- 05.0628.40
- 05.0628.14
- Dali Version
- 05.0628.40.DA
- 05.0628.14.DA
- Mains Dimming
- 05.0628.40.NI
- 05.0628.14.NI
- Casambi
- 05.0628.40.CB
- 05.0628.14.CB
- Non Dimmable
- 05.0629.40
- 05.0629.14
- Dali Version
- 05.0629.40.DA
- 05.0629.14.DA
- Mains Dimming
- 05.0629.40.NI
- 05.0629.14.NI
- Casambi
- 05.0629.40.CB
- 05.0629.14.CB
- Non Dimmable
- 05.0627.40
- 05.0627.14
- Dali Version
- 05.0627.40.DA
- 05.0627.14.DA
- Mains Dimming
- 05.0627.40.NI
- 05.0627.14.NI
- Casambi
- 05.0627.40.CB
- 05.0627.14.CB

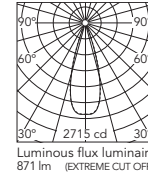





















Beam Angle: 33°

h(m)	E(lx)	D(m)
1	2715	0.59
2	679	1.18
3	301	1.78
4	170	2.37
5	109	2.96







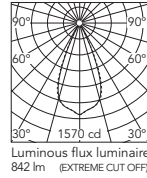













Luminous flux luminaire 871 lm (EXTREME CUT OFF)
@White (40)

Optic Wide Flood 2700K

-  Non Dimmable
05.0630.40
05.0630.14
-  05.0630.40.DA
05.0630.14.DA
-  05.0630.40.NI
05.0630.14.NI
-  05.0630.40.CB
05.0630.14.CB
-  05.0631.40
05.0631.14
-  05.0631.40.DA
05.0631.14.DA
-  05.0631.40.NI
05.0631.14.NI
-  05.0631.40.CB
05.0631.14.CB
-  05.0633.40
05.0633.14
-  05.0633.40.DA
05.0633.14.DA
-  05.0633.40.NI
05.0633.14.NI
-  05.0633.40.CB
05.0633.14.CB
-  05.0634.40
05.0634.14
-  05.0634.40.DA
05.0634.14.DA
-  05.0634.40.NI
05.0634.14.NI
-  05.0634.40.CB
05.0634.14.CB
-  05.0632.40
05.0632.14
-  05.0632.40.DA
05.0632.14.DA
-  05.0632.40.NI
05.0632.14.NI
-  05.0632.40.CB
05.0632.14.CB



Optic Wide Flood 3000K

-  Non Dimmable
05.0635.40
05.0635.14
-  05.0635.40.DA
05.0635.14.DA
-  05.0635.40.NI
05.0635.14.NI
-  05.0635.40.CB
05.0635.14.CB
-  05.0636.40
05.0636.14
-  05.0636.40.DA
05.0636.14.DA
-  05.0636.40.NI
05.0636.14.NI
-  05.0636.40.CB
05.0636.14.CB
-  05.0638.40
05.0638.14
-  05.0638.40.DA
05.0638.14.DA
-  05.0638.40.NI
05.0638.14.NI
-  05.0638.40.CB
05.0638.14.CB
-  05.0639.40
05.0639.14
-  05.0639.40.DA
05.0639.14.DA
-  05.0639.40.NI
05.0639.14.NI
-  05.0639.40.CB
05.0639.14.CB
-  05.0637.40
05.0637.14
-  05.0637.40.DA
05.0637.14.DA
-  05.0637.40.NI
05.0637.14.NI
-  05.0637.40.CB
05.0637.14.CB

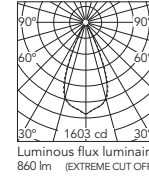

LIGHT SHADOW

Light Shadow Fixed Trim 8 Spots

Light Source: Power LED DC 900 mA 21,6W - 2160 lm - 2700K/CRI 90 / 21,6W - 2280 lm - 3000K/CRI 90
 Mains dimming: Power LED DC 750 mA 18,5W - 1800 lm - 2700K/CRI 90 / 18,5W - 1900 lm - 3000K/CRI 90

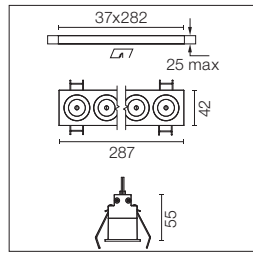

GWT 850°
 IP 55
 0.50 Kg
 Eco
 F
 TEGEE
 10 - 100%
 h=75 min
 CE
 DALI
 LED INCL

Leuchte für Unterputzmontage mit 8 LED-Lichtquellen. Externes Netzgerät eingeschlossen (220-240V). Vorinstallationsrahmen nicht erforderlich.

Recessed integrated luminaire with 8 LED lighting spots. Remote power supply included (220-240V). Pre-installation frame not required.

E= Außenfarbe
I= Innenfarbe

E= External Finish
I= Internal Finish

Optic Spot 2700K

- | | |
|--|---------------|
| | Non Dimmable |
| | 03.8836.40A |
| | 03.8836.14A |
| | Dali Version |
| | 03.8836.40ADA |
| | 03.8836.14ADA |
| | Mains Dimming |
| | 03.8836.40ANI |
| | 03.8836.14ANI |
| | Casambi |
| | 03.8836.40ACB |
| | 03.8836.14ACB |
| | Non Dimmable |
| | 03.8837.40A |
| | 03.8837.14A |
| | Dali Version |
| | 03.8837.40ADA |
| | 03.8837.14ADA |
| | Mains Dimming |
| | 03.8837.40ANI |
| | 03.8837.14ANI |
| | Casambi |
| | 03.8837.40ACB |
| | 03.8837.14ACB |
| | Non Dimmable |
| | 05.1200.40A |
| | 05.1200.14A |
| | Dali Version |
| | 05.1200.40ADA |
| | 05.1200.14ADA |
| | Mains Dimming |
| | 05.1200.40ANI |
| | 05.1200.14ANI |
| | Casambi |
| | 05.1200.40ACB |
| | 05.1200.14ACB |
| | Non Dimmable |
| | 05.1201.40A |
| | 05.1201.14A |
| | Dali Version |
| | 05.1201.40ADA |
| | 05.1201.14ADA |
| | Mains Dimming |
| | 05.1201.40ANI |
| | 05.1201.14ANI |
| | Casambi |
| | 05.1201.40ACB |
| | 05.1201.14ACB |
| | Non Dimmable |
| | 05.1202.40A |
| | 05.1202.14A |
| | Dali Version |
| | 05.1202.40ADA |
| | 05.1202.14ADA |
| | Mains Dimming |
| | 05.1202.40ANI |
| | 05.1202.14ANI |
| | Casambi |
| | 05.1202.40ACB |
| | 05.1202.14ACB |

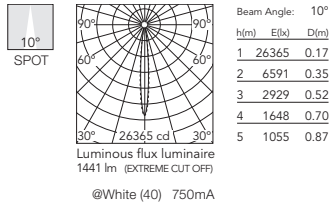
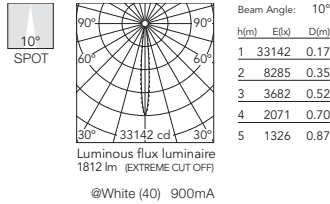





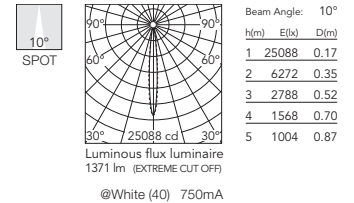
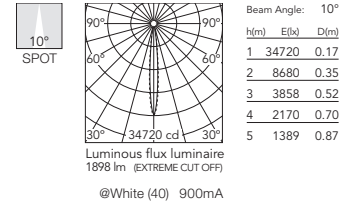















Optic Spot 3000K

- | | |
|--|---------------|
| | Non Dimmable |
| | 03.8840.40A |
| | 03.8840.14A |
| | Dali Version |
| | 03.8840.40ADA |
| | 03.8840.14ADA |
| | Mains Dimming |
| | 03.8840.40ANI |
| | 03.8840.14ANI |
| | Casambi |
| | 03.8840.40ACB |
| | 03.8840.14ACB |
| | Non Dimmable |
| | 03.8841.40A |
| | 03.8841.14A |
| | Dali Version |
| | 03.8841.40ADA |
| | 03.8841.14ADA |
| | Mains Dimming |
| | 03.8841.40ANI |
| | 03.8841.14ANI |
| | Casambi |
| | 03.8841.40ACB |
| | 03.8841.14ACB |
| | Non Dimmable |
| | 05.1205.40A |
| | 05.1205.14A |
| | Dali Version |
| | 05.1205.40ADA |
| | 05.1205.14ADA |
| | Mains Dimming |
| | 05.1205.40ANI |
| | 05.1205.14ANI |
| | Casambi |
| | 05.1205.40ACB |
| | 05.1205.14ACB |
| | Non Dimmable |
| | 05.1206.40A |
| | 05.1206.14A |
| | Dali Version |
| | 05.1206.40ADA |
| | 05.1206.14ADA |
| | Mains Dimming |
| | 05.1206.40ANI |
| | 05.1206.14ANI |
| | Casambi |
| | 05.1206.40ACB |
| | 05.1206.14ACB |
| | Non Dimmable |
| | 05.1207.40A |
| | 05.1207.14A |
| | Dali Version |
| | 05.1207.40ADA |
| | 05.1207.14ADA |
| | Mains Dimming |
| | 05.1207.40ANI |
| | 05.1207.14ANI |
| | Casambi |
| | 05.1207.40ACB |
| | 05.1207.14ACB |



Optic Medium 2700K

-  Non Dimmable
03.9140.40A
03.9140.14A
Dali Version
-  03.9140.40ADA
03.9140.14ADA
Mains Dimming
-  03.9140.40ANI
03.9140.14ANI
Casambi
-  03.9140.40ACB
03.9140.14ACB
Non Dimmable
-  03.9141.40A
03.9141.14A
Dali Version
-  03.9141.40ADA
03.9141.14ADA
Mains Dimming
-  03.9141.40ANI
03.9141.14ANI
Casambi
-  03.9141.40ACB
03.9141.14ACB
Non Dimmable
-  05.1210.40A
05.1210.14A
Dali Version
-  05.1210.40ADA
05.1210.14ADA
Mains Dimming
-  05.1210.40ANI
05.1210.14ANI
Casambi
-  05.1210.40ACB
05.1210.14ACB
Non Dimmable
-  05.1211.40A
05.1211.14A
Dali Version
-  05.1211.40ADA
05.1211.14ADA
Mains Dimming
-  05.1211.40ANI
05.1211.14ANI
Casambi
-  05.1211.40ACB
05.1211.14ACB
Non Dimmable
-  05.1212.40A
05.1212.14A
Dali Version
-  05.1212.40ADA
05.1212.14ADA
Mains Dimming
-  05.1212.40ANI
05.1212.14ANI
Casambi
-  05.1212.40ACB
05.1212.14ACB

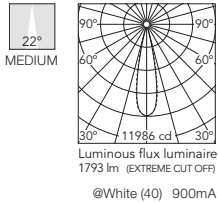

Beam Angle: 22°



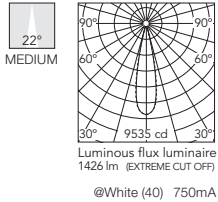

















h(m)	E(lx)	D(m)
1	11986	0.39
2	2996	0.78
3	1332	1.17
4	749	1.56
5	479	1.95



Beam Angle: 22°

h(m)	E(lx)	D(m)
1	9535	0.39
2	2384	0.78
3	1059	1.17
4	596	1.56
5	381	1.95

Optic Medium 3000K

-  Non Dimmable
03.9150.40A
03.9150.14A
Dali Version
-  03.9150.40ADA
03.9150.14ADA
Mains Dimming
-  03.9150.40ANI
03.9150.14ANI
Casambi
-  03.9150.40ACB
03.9150.14ACB
Non Dimmable
-  03.9151.40A
03.9151.14A
Dali Version
-  03.9151.40ADA
03.9151.14ADA
Mains Dimming
-  03.9151.40ANI
03.9151.14ANI
Casambi
-  03.9151.40ACB
03.9151.14ACB
Non Dimmable
-  05.1215.40A
05.1215.14A
Dali Version
-  05.1215.40ADA
05.1215.14ADA
Mains Dimming
-  05.1215.40ANI
05.1215.14ANI
Casambi
-  05.1215.40ACB
05.1215.14ACB
Non Dimmable
-  05.1216.40A
05.1216.14A
Dali Version
-  05.1216.40ADA
05.1216.14ADA
Mains Dimming
-  05.1216.40ANI
05.1216.14ANI
Casambi
-  05.1216.40ACB
05.1216.14ACB
Non Dimmable
-  05.1217.40A
05.1217.14A
Dali Version
-  05.1217.40ADA
05.1217.14ADA
Mains Dimming
-  05.1217.40ANI
05.1217.14ANI
Casambi
-  05.1217.40ACB
05.1217.14ACB

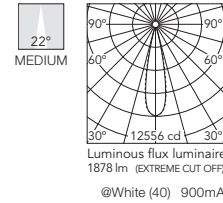

Beam Angle: 22°

h(m)	E(lx)	D(m)
1	12556	0.39
2	3139	0.78
3	1395	1.17
4	785	1.56
5	502	1.95

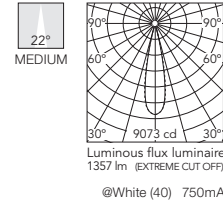

Beam Angle: 22°

h(m)	E(lx)	D(m)
1	9073	0.39
2	2268	0.78
3	1008	1.17
4	567	1.56
5	363	1.95

Light Shadow Fixed Trim 8 Spots

Light Source: Power LED DC 900 mA 21,6W - 2160 lm - 2700K/CRI 90 / 21,6W - 2280 lm - 3000K/CRI 90
 Mains dimming: Power LED DC 750 mA 18,5W - 1800 lm - 2700K/CRI 90 / 18,5W - 1900 lm - 3000K/CRI 90

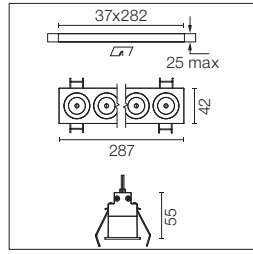

GWT 850°
 IP 55
 0,50 Kg
 10 - 100%
 h=75 min
 CE
 DALI
 LED INCL

Leuchte für Unterputzmontage mit 8 LED-Lichtquellen. Externes Netzgerät eingeschlossen (220-240V). Vorinstallationsrahmen nicht erforderlich.

Recessed integrated luminaire with 8 LED lighting spots. Remote power supply included (220-240V). Pre-installation frame not required.

E= Außenfarbe
 I= Innenfarbe

E= External Finish
 I= Internal Finish

Optic Flood 2700K

- E I Non Dimmable
- 03.9145.40A
- 03.9145.14A
- Dali Version
- 03.9145.40ADA
- 03.9145.14ADA
- Mains Dimming
- 03.9145.40ANI
- 03.9145.14ANI
- Casambi
- 03.9145.40ACB
- 03.9145.14ACB
- Non Dimmable
- 03.9146.40A
- 03.9146.14A
- Dali Version
- 03.9146.40ADA
- 03.9146.14ADA
- Mains Dimming
- 03.9146.40ANI
- 03.9146.14ANI
- Casambi
- 03.9146.40ACB
- 03.9146.14ACB
- Non Dimmable
- 05.1220.40A
- 05.1220.14A
- Dali Version
- 05.1220.40ADA
- 05.1220.14ADA
- Mains Dimming
- 05.1220.40ANI
- 05.1220.14ANI
- Casambi
- 05.1220.40ACB
- 05.1220.14ACB
- Non Dimmable
- 05.1221.40A
- 05.1221.14A
- Dali Version
- 05.1221.40ADA
- 05.1221.14ADA
- Mains Dimming
- 05.1221.40ANI
- 05.1221.14ANI
- Casambi
- 05.1221.40ACB
- 05.1221.14ACB
- Non Dimmable
- 05.1222.40A
- 05.1222.14A
- Dali Version
- 05.1222.40ADA
- 05.1222.14ADA
- Mains Dimming
- 05.1222.40ANI
- 05.1222.14ANI
- Casambi
- 05.1222.40ACB
- 05.1222.14ACB

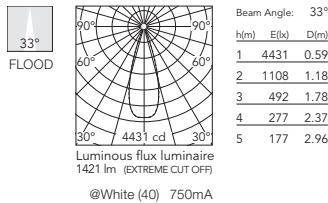
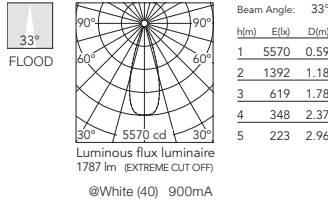





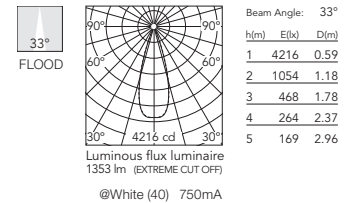
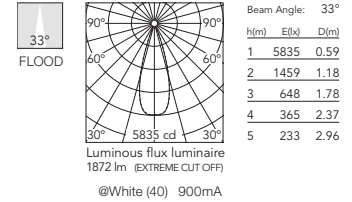



































Optic Flood 3000K

- E I Non Dimmable
- 03.9155.40A
- 03.9155.14A
- Dali Version
- 03.9155.40ADA
- 03.9155.14ADA
- Mains Dimming
- 03.9155.40ANI
- 03.9155.14ANI
- Casambi
- 03.9155.40ACB
- 03.9155.14ACB
- Non Dimmable
- 03.9156.40A
- 03.9156.14A
- Dali Version
- 03.9156.40ADA
- 03.9156.14ADA
- Mains Dimming
- 03.9156.40ANI
- 03.9156.14ANI
- Casambi
- 03.9156.40ACB
- 03.9156.14ACB
- Non Dimmable
- 05.1225.40A
- 05.1225.14A
- Dali Version
- 05.1225.40ADA
- 05.1225.14ADA
- Mains Dimming
- 05.1225.40ANI
- 05.1225.14ANI
- Casambi
- 05.1225.40ACB
- 05.1225.14ACB
- Non Dimmable
- 05.1226.40A
- 05.1226.14A
- Dali Version
- 05.1226.40ADA
- 05.1226.14ADA
- Mains Dimming
- 05.1226.40ANI
- 05.1226.14ANI
- Casambi
- 05.1226.40ACB
- 05.1226.14ACB
- Non Dimmable
- 05.1227.40A
- 05.1227.14A
- Dali Version
- 05.1227.40ADA
- 05.1227.14ADA
- Mains Dimming
- 05.1227.40ANI
- 05.1227.14ANI
- Casambi
- 05.1227.40ACB
- 05.1227.14ACB







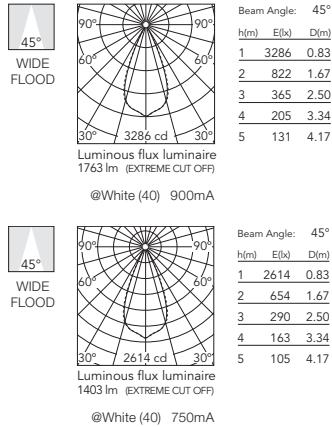



































Optic Wide Flood 2700K

-  Non Dimmable
-  03.8316.40A
-  03.8316.14A
- Dali Version
-  03.8316.40ADA
-  03.8316.14ADA
- Mains Dimming
-  03.8316.40ANI
-  03.8316.14ANI
- Casambi
-  03.8316.40ACB
-  03.8316.14ACB
- Non Dimmable
-  03.8317.40A
-  03.8317.14A
- Dali Version
-  03.8317.40ADA
-  03.8317.14ADA
- Mains Dimming
-  03.8317.40ANI
-  03.8317.14ANI
- Casambi
-  03.8317.40ACB
-  03.8317.14ACB
- Non Dimmable
-  05.1230.40A
-  05.1230.14A
- Dali Version
-  05.1230.40ADA
-  05.1230.14ADA
- Mains Dimming
-  05.1230.40ANI
-  05.1230.14ANI
- Casambi
-  05.1230.40ACB
-  05.1230.14ACB
- Non Dimmable
-  05.1231.40A
-  05.1231.14A
- Dali Version
-  05.1231.40ADA
-  05.1231.14ADA
- Mains Dimming
-  05.1231.40ANI
-  05.1231.14ANI
- Casambi
-  05.1231.40ACB
-  05.1231.14ACB
- Non Dimmable
-  05.1232.40A
-  05.1232.14A
- Dali Version
-  05.1232.40ADA
-  05.1232.14ADA
- Mains Dimming
-  05.1232.40ANI
-  05.1232.14ANI
- Casambi
-  05.1232.40ACB
-  05.1232.14ACB



Optic Wide Flood 3000K

-  Non Dimmable
-  03.8320.40A
-  03.8320.14A
- Dali Version
-  03.8320.40ADA
-  03.8320.14ADA
- Mains Dimming
-  03.8320.40ANI
-  03.8320.14ANI
- Casambi
-  03.8320.40ACB
-  03.8320.14ACB
- Non Dimmable
-  03.8321.40A
-  03.8321.14A
- Dali Version
-  03.8321.40ADA
-  03.8321.14ADA
- Mains Dimming
-  03.8321.40ANI
-  03.8321.14ANI
- Casambi
-  03.8321.40ACB
-  03.8321.14ACB
- Non Dimmable
-  05.1235.40A
-  05.1235.14A
- Dali Version
-  05.1235.40ADA
-  05.1235.14ADA
- Mains Dimming
-  05.1235.40ANI
-  05.1235.14ANI
- Casambi
-  05.1235.40ACB
-  05.1235.14ACB
- Non Dimmable
-  05.1236.40A
-  05.1236.14A
- Dali Version
-  05.1236.40ADA
-  05.1236.14ADA
- Mains Dimming
-  05.1236.40ANI
-  05.1236.14ANI
- Casambi
-  05.1236.40ACB
-  05.1236.14ACB
- Non Dimmable
-  05.1237.40A
-  05.1237.14A
- Dali Version
-  05.1237.40ADA
-  05.1237.14ADA
- Mains Dimming
-  05.1237.40ANI
-  05.1237.14ANI
- Casambi
-  05.1237.40ACB
-  05.1237.14ACB

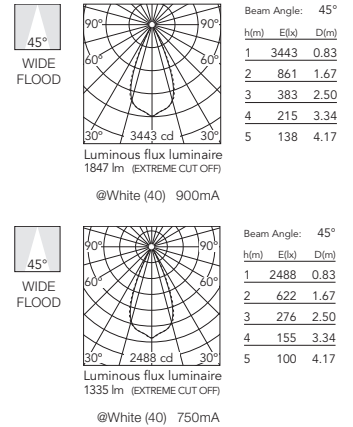

Light Shadow Fixed Trim 12 Spots

Light Source: Power LED DC 900 mA 32,4W - 3240 lm - 2700K/CRI 90 / 32,4W - 3420 lm - 3000K/CRI 90
 Mains dimming: Power LED DC 750 mA 28W - 2710 lm - 2700K/CRI 90 / 28W - 2860 lm - 3000K/CRI 90

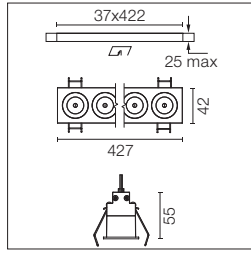

GWT 850° IP 55
 0,66 Kg
 h=75 min
 CE
 LED INCL

Leuchte für Unterputzmontage mit 12 LED-Lichtquellen. Externes Netzgerät eingeschlossen (220-240V). Vorinstallationsrahmen nicht erforderlich.

Recessed integrated luminaire with 12 LED lighting spots. Remote power supply included (220-240V). Pre-installation frame not required.

E= Außenfarbe
 I= Innenfarbe

E= External Finish
 I= Internal Finish

Optic Spot 2700K

- E I Non Dimmable
- 03.8844.40A
- 03.8844.14A
- Dali & Push Version
- 03.8844.40ADA
- 03.8844.14ADA
- Mains Dimming
- 03.8844.40ANI
- 03.8844.14ANI
- Casambi
- 03.8844.40ACB
- 03.8844.14ACB
- Non Dimmable
- 03.8845.40A
- 03.8845.14A
- Dali & Push Version
- 03.8845.40ADA
- 03.8845.14ADA
- Mains Dimming
- 03.8845.40ANI
- 03.8845.14ANI
- Casambi
- 03.8845.40ACB
- 03.8845.14ACB
- Non Dimmable
- 05.1300.40A
- 05.1300.14A
- Dali & Push Version
- 05.1300.40ADA
- 05.1300.14ADA
- Mains Dimming
- 05.1300.40ANI
- 05.1300.14ANI
- Casambi
- 05.1300.40ACB
- 05.1300.14ACB
- Non Dimmable
- 05.1301.40A
- 05.1301.14A
- Dali & Push Version
- 05.1301.40ADA
- 05.1301.14ADA
- Mains Dimming
- 05.1301.40ANI
- 05.1301.14ANI
- Casambi
- 05.1301.40ACB
- 05.1301.14ACB
- Non Dimmable
- 05.1302.40A
- 05.1302.14A
- Dali & Push Version
- 05.1302.40ADA
- 05.1302.14ADA
- Mains Dimming
- 05.1302.40ANI
- 05.1302.14ANI
- Casambi
- 05.1302.40ACB
- 05.1302.14ACB

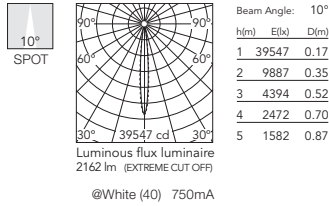
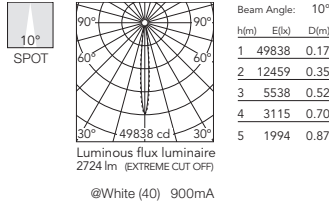





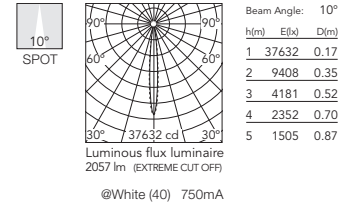
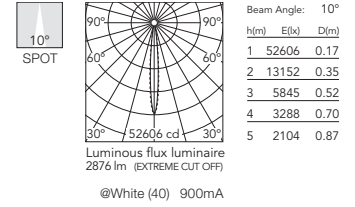















Optic Spot 3000K

- E I Non Dimmable
- 03.8848.40A
- 03.8848.14A
- Dali & Push Version
- 03.8848.40ADA
- 03.8848.14ADA
- Mains Dimming
- 03.8848.40ANI
- 03.8848.14ANI
- Casambi
- 03.8848.40ACB
- 03.8848.14ACB
- Non Dimmable
- 03.8849.40A
- 03.8849.14A
- Dali & Push Version
- 03.8849.40ADA
- 03.8849.14ADA
- Mains Dimming
- 03.8849.40ANI
- 03.8849.14ANI
- Casambi
- 03.8849.40ACB
- 03.8849.14ACB
- Non Dimmable
- 05.1305.40A
- 05.1305.14A
- Dali & Push Version
- 05.1305.40ADA
- 05.1305.14ADA
- Mains Dimming
- 05.1305.40ANI
- 05.1305.14ANI
- Casambi
- 05.1305.40ACB
- 05.1305.14ACB
- Non Dimmable
- 05.1306.40A
- 05.1306.14A
- Dali & Push Version
- 05.1306.40ADA
- 05.1306.14ADA
- Mains Dimming
- 05.1306.40ANI
- 05.1306.14ANI
- Casambi
- 05.1306.40ACB
- 05.1306.14ACB
- Non Dimmable
- 05.1307.40A
- 05.1307.14A
- Dali & Push Version
- 05.1307.40ADA
- 05.1307.14ADA
- Mains Dimming
- 05.1307.40ANI
- 05.1307.14ANI
- Casambi
- 05.1307.40ACB
- 05.1307.14ACB







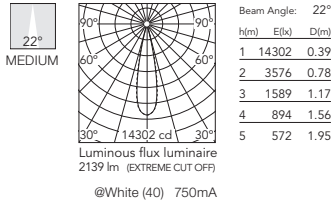
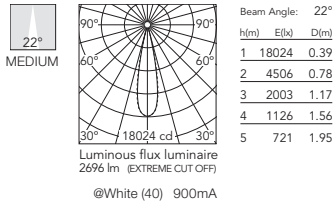















**Optic Medium
2700K**

-  Non Dimmable
03.9160.40A
03.9160.14A
Dali & Push Version
-  03.9160.40ADA
03.9160.14ADA
Mains Dimming
-  03.9160.40ANI
03.9160.14ANI
Casambi
-  03.9160.40ACB
03.9160.14ACB
Non Dimmable
-  03.9161.40A
03.9161.14A
Dali & Push Version
-  03.9161.40ADA
03.9161.14ADA
Mains Dimming
-  03.9161.40ANI
03.9161.14ANI
Casambi
-  03.9161.40ACB
03.9161.14ACB
Non Dimmable
-  05.1310.40A
05.1310.14A
Dali & Push Version
-  05.1310.40ADA
05.1310.14ADA
Mains Dimming
-  05.1310.40ANI
05.1310.14ANI
Casambi
-  05.1310.40ACB
05.1310.14ACB
Non Dimmable
-  05.1311.40A
05.1311.14A
Dali & Push Version
-  05.1311.40ADA
05.1311.14ADA
Mains Dimming
-  05.1311.40ANI
05.1311.14ANI
Casambi
-  05.1311.40ACB
05.1311.14ACB
Non Dimmable
-  05.1312.40A
05.1312.14A
Dali & Push Version
-  05.1312.40ADA
05.1312.14ADA
Mains Dimming
-  05.1312.40ANI
05.1312.14ANI
Casambi
-  05.1312.40ACB
05.1312.14ACB



**Optic Medium
3000K**

-  Non Dimmable
03.9170.40A
03.9170.14A
Dali & Push Version
-  03.9170.40ADA
03.9170.14ADA
Mains Dimming
-  03.9170.40ANI
03.9170.14ANI
Casambi
-  03.9170.40ACB
03.9170.14ACB
Non Dimmable
-  03.9171.40A
03.9171.14A
Dali & Push Version
-  03.9171.40ADA
03.9171.14ADA
Mains Dimming
-  03.9171.40ANI
03.9171.14ANI
Casambi
-  03.9171.40ACB
03.9171.14ACB
Non Dimmable
-  05.1315.40A
05.1315.14A
Dali & Push Version
-  05.1315.40ADA
05.1315.14ADA
Mains Dimming
-  05.1315.40ANI
05.1315.14ANI
Casambi
-  05.1315.40ACB
05.1315.14ACB
Non Dimmable
-  05.1316.40A
05.1316.14A
Dali & Push Version
-  05.1316.40ADA
05.1316.14ADA
Mains Dimming
-  05.1316.40ANI
05.1316.14ANI
Casambi
-  05.1316.40ACB
05.1316.14ACB
Non Dimmable
-  05.1317.40A
05.1317.14A
Dali & Push Version
-  05.1317.40ADA
05.1317.14ADA
Mains Dimming
-  05.1317.40ANI
05.1317.14ANI
Casambi
-  05.1317.40ACB
05.1317.14ACB

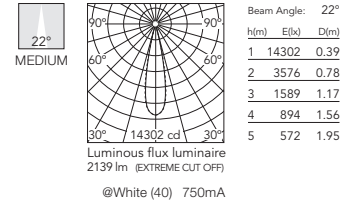
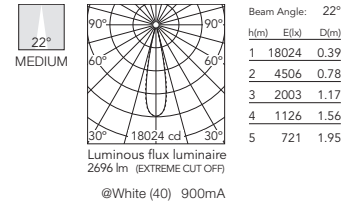

Light Shadow Fixed Trim 12 Spots

Light Source: Power LED DC 900 mA 32,4W - 3240 lm - 2700K/CRI 90 / 32,4W - 3420 lm - 3000K/CRI 90
 Mains dimming: Power LED DC 750 mA 28W - 2710 lm - 2700K/CRI 90 / 28W - 2860 lm - 3000K/CRI 90

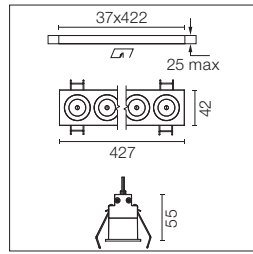

GWT 850° IP 55
 0,66 Kg
 h=75 min
 CE
 LED INCL

Leuchte für Unterputzmontage mit 12 LED-Lichtquellen. Externes Netzgerät eingeschlossen (220-240V). Vorinstallationsrahmen nicht erforderlich.

Recessed integrated luminaire with 12 LED lighting spots. Remote power supply included (220-240V). Pre-installation frame not required.

E= Außenfarbe
 I= Innenfarbe

E= External Finish
 I= Internal Finish

Optic Flood 2700K

- E I Non Dimmable
- 03.9165.40A
- 03.9165.14A
- Dali & Push Version
- 03.9165.40ADA
- 03.9165.14ADA
- Mains Dimming
- 03.9165.40ANI
- 03.9165.14ANI
- Casambi
- 03.9165.40ACB
- 03.9165.14ACB
- Non Dimmable
- 03.9166.40A
- 03.9166.14A
- Dali & Push Version
- 03.9166.40ADA
- 03.9166.14ADA
- Mains Dimming
- 03.9166.40ANI
- 03.9166.14ANI
- Casambi
- 03.9166.40ACB
- 03.9166.14ACB
- Non Dimmable
- 05.1320.40A
- 05.1320.14A
- Dali & Push Version
- 05.1320.40ADA
- 05.1320.14ADA
- Mains Dimming
- 05.1320.40ANI
- 05.1320.14ANI
- Casambi
- 05.1320.40ACB
- 05.1320.14ACB
- Non Dimmable
- 05.1321.40A
- 05.1321.14A
- Dali & Push Version
- 05.1321.40ADA
- 05.1321.14ADA
- Mains Dimming
- 05.1321.40ANI
- 05.1321.14ANI
- Casambi
- 05.1321.40ACB
- 05.1321.14ACB
- Non Dimmable
- 05.1322.40A
- 05.1322.14A
- Dali & Push Version
- 05.1322.40ADA
- 05.1322.14ADA
- Mains Dimming
- 05.1322.40ANI
- 05.1322.14ANI
- Casambi
- 05.1322.40ACB
- 05.1322.14ACB

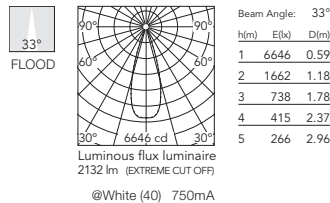
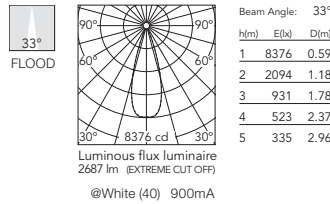





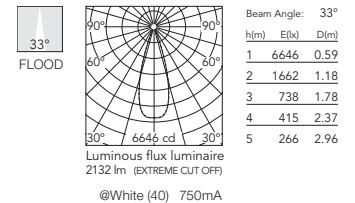
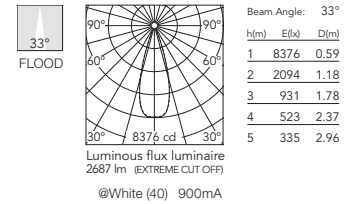

















































Optic Flood 3000K

- E I Non Dimmable
- 03.9175.40A
- 03.9175.14A
- Dali & Push Version
- 03.9175.40ADA
- 03.9175.14ADA
- Mains Dimming
- 03.9175.40ANI
- 03.9175.14ANI
- Casambi
- 03.9175.40ACB
- 03.9175.14ACB
- Non Dimmable
- 03.9176.40A
- 03.9176.14A
- Dali & Push Version
- 03.9176.40ADA
- 03.9176.14ADA
- Mains Dimming
- 03.9176.40ANI
- 03.9176.14ANI
- Casambi
- 03.9176.40ACB
- 03.9176.14ACB
- Non Dimmable
- 05.1325.40A
- 05.1325.14A
- Dali & Push Version
- 05.1325.40ADA
- 05.1325.14ADA
- Mains Dimming
- 05.1325.40ANI
- 05.1325.14ANI
- Casambi
- 05.1325.40ACB
- 05.1325.14ACB
- Non Dimmable
- 05.1326.40A
- 05.1326.14A
- Dali & Push Version
- 05.1326.40ADA
- 05.1326.14ADA
- Mains Dimming
- 05.1326.40ANI
- 05.1326.14ANI
- Casambi
- 05.1326.40ACB
- 05.1326.14ACB
- Non Dimmable
- 05.1327.40A
- 05.1327.14A
- Dali & Push Version
- 05.1327.40ADA
- 05.1327.14ADA
- Mains Dimming
- 05.1327.40ANI
- 05.1327.14ANI
- Casambi
- 05.1327.40ACB
- 05.1327.14ACB



Optic Wide Flood 2700K

-  Non Dimmable
-  03.8324.40A
-  03.8324.14A
-  Dali & Push Version
-  03.8324.40ADA
-  03.8324.14ADA
-  Mains Dimming
-  03.8324.40ANI
-  03.8324.14ANI
-  Casambi
-  03.8324.40ACB
-  03.8324.14ACB
-  Non Dimmable
-  03.8325.40A
-  03.8325.14A
-  Dali & Push Version
-  03.8325.40ADA
-  03.8325.14ADA
-  Mains Dimming
-  03.8325.40ANI
-  03.8325.14ANI
-  Casambi
-  03.8325.40ACB
-  03.8325.14ACB
-  Non Dimmable
-  05.1330.40A
-  05.1330.14A
-  Dali & Push Version
-  05.1330.40ADA
-  05.1330.14ADA
-  Mains Dimming
-  05.1330.40ANI
-  05.1330.14ANI
-  Casambi
-  05.1330.40ACB
-  05.1330.14ACB
-  Non Dimmable
-  05.1331.40A
-  05.1331.14A
-  Dali & Push Version
-  05.1331.40ADA
-  05.1331.14ADA
-  Mains Dimming
-  05.1331.40ANI
-  05.1331.14ANI
-  Casambi
-  05.1331.40ACB
-  05.1331.14ACB
-  Non Dimmable
-  05.1332.40A
-  05.1332.14A
-  Dali & Push Version
-  05.1332.40ADA
-  05.1332.14ADA
- Mains Dimming
- 05.1332.40ANI
- 05.1332.14ANI
- Casambi
- 05.1332.40ACB
- 05.1332.14ACB

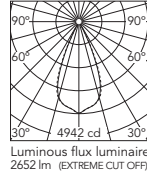

Beam Angle: 45°

h(m)	E(flx)	D(m)
1	4942	0.83
2	1235	1.67
3	549	2.50
4	309	3.34
5	198	4.17

Luminous flux luminaire 2652 lm (EXTREME CUT OFF)
@White (40) 900mA

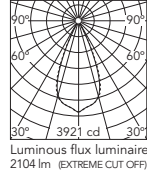























































Beam Angle: 45°

h(m)	E(flx)	D(m)
1	3921	0.83
2	980	1.67
3	436	2.50
4	245	3.34
5	157	4.17

Luminous flux luminaire 2104 lm (EXTREME CUT OFF)
@White (40) 750mA

Optic Wide Flood 3000K

-  Non Dimmable
-  03.8328.40A
-  03.8328.14A
-  Dali & Push Version
-  03.8328.40ADA
-  03.8328.14ADA
-  Mains Dimming
-  03.8328.40ANI
-  03.8328.14ANI
-  Casambi
-  03.8328.40ACB
-  03.8328.14ACB
-  Non Dimmable
-  03.8329.40A
-  03.8329.14A
-  Dali & Push Version
-  03.8329.40ADA
-  03.8329.14ADA
-  Mains Dimming
-  03.8329.40ANI
-  03.8329.14ANI
-  Casambi
-  03.8329.40ACB
-  03.8329.14ACB
-  Non Dimmable
-  05.1335.40A
-  05.1335.14A
-  Dali & Push Version
-  05.1335.40ADA
-  05.1335.14ADA
-  Mains Dimming
-  05.1335.40ANI
-  05.1335.14ANI
-  Casambi
-  05.1335.40ACB
-  05.1335.14ACB
-  Non Dimmable
-  05.1336.40A
-  05.1336.14A
-  Dali & Push Version
-  05.1336.40ADA
-  05.1336.14ADA
-  Mains Dimming
-  05.1336.40ANI
-  05.1336.14ANI
-  Casambi
-  05.1336.40ACB
-  05.1336.14ACB
-  Non Dimmable
-  05.1337.40A
-  05.1337.14A
-  Dali & Push Version
-  05.1337.40ADA
-  05.1337.14ADA
- Mains Dimming
- 05.1337.40ANI
- 05.1337.14ANI
- Casambi
- 05.1337.40ACB
- 05.1337.14ACB

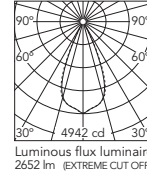

Beam Angle: 45°

h(m)	E(flx)	D(m)
1	4942	0.83
2	1235	1.67
3	549	2.50
4	309	3.34
5	198	4.17

Luminous flux luminaire 2652 lm (EXTREME CUT OFF)
@White (40) 900mA

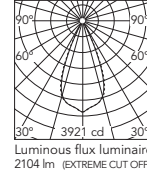

Beam Angle: 45°

h(m)	E(flx)	D(m)
1	3921	0.83
2	980	1.67
3	436	2.50
4	245	3.34
5	157	4.17

Luminous flux luminaire 2104 lm (EXTREME CUT OFF)
@White (40) 750mA

LIGHT SHADOW

Light Shadow Fixed No Trim 2 Spots

Light Source: Power LED DC 900 mA 5,4W - 540 lm - 2700K/CRI 90 / 5,4W - 570 lm - 3000K/CRI 90

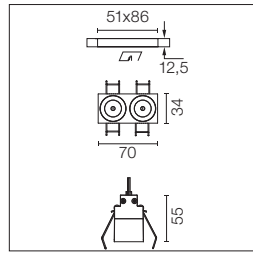

- GWT 850°
- IP 55
- 0,25 Kg
- 03
- F
- h=150 mm
- TECEE
- 10 - 100%
- CE
- DALI
- LED INCL

Leuchte für Unterputzmontage mit 2 LED-Lichtquellen. Externes Netzgerät eingeschlossen (220-240V). Vorinstallationsrahmen. Muss separat bestellt werden.

Recessed integrated luminaire with 2 LED lighting spots. Remote power supply included (220-240V). It requires a pre-installation frame, to be ordered separately.

E= Außenfarbe
I= Innenfarbe

E= External Finish
I= Internal Finish

Optic Spot 2700K

- | | |
|--|---------------|
| | Non Dimmable |
| | 03.8852.40A |
| | 03.8852.14A |
| | Dali Version |
| | 03.8852.40ADA |
| | 03.8852.14ADA |
| | Mains Dimming |
| | 03.8852.40ANI |
| | 03.8852.14ANI |
| | Casambi |
| | 03.8852.40ACB |
| | 03.8852.14ACB |
| | Non Dimmable |
| | 03.8853.40A |
| | 03.8853.14A |
| | Dali Version |
| | 03.8853.40ADA |
| | 03.8853.14ADA |
| | Mains Dimming |
| | 03.8853.40ANI |
| | 03.8853.14ANI |
| | Casambi |
| | 03.8853.40ACB |
| | 03.8853.14ACB |
| | Non Dimmable |
| | 05.1040.40A |
| | 05.1040.14A |
| | Dali Version |
| | 05.1040.40ADA |
| | 05.1040.14ADA |
| | Mains Dimming |
| | 05.1040.40ANI |
| | 05.1040.14ANI |
| | Casambi |
| | 05.1040.40ACB |
| | 05.1040.14ACB |
| | Non Dimmable |
| | 05.1041.40A |
| | 05.1041.14A |
| | Dali Version |
| | 05.1041.40ADA |
| | 05.1041.14ADA |
| | Mains Dimming |
| | 05.1041.40ANI |
| | 05.1041.14ANI |
| | Casambi |
| | 05.1041.40ACB |
| | 05.1041.14ACB |
| | Non Dimmable |
| | 05.1042.40A |
| | 05.1042.14A |
| | Dali Version |
| | 05.1042.40ADA |
| | 05.1042.14ADA |
| | Mains Dimming |
| | 05.1042.40ANI |
| | 05.1042.14ANI |
| | Casambi |
| | 05.1042.40ACB |
| | 05.1042.14ACB |

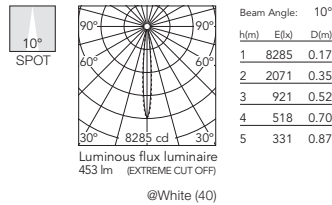





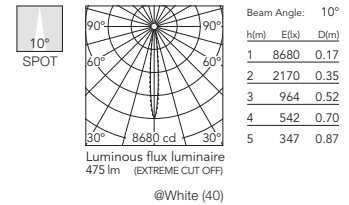















Optic Spot 3000K

- | | |
|--|---------------|
| | Non Dimmable |
| | 03.8856.40A |
| | 03.8856.14A |
| | Dali Version |
| | 03.8856.40ADA |
| | 03.8856.14ADA |
| | Mains Dimming |
| | 03.8856.40ANI |
| | 03.8856.14ANI |
| | Casambi |
| | 03.8856.40ACB |
| | 03.8856.14ACB |
| | Non Dimmable |
| | 03.8857.40A |
| | 03.8857.14A |
| | Dali Version |
| | 03.8857.40ADA |
| | 03.8857.14ADA |
| | Mains Dimming |
| | 03.8857.40ANI |
| | 03.8857.14ANI |
| | Casambi |
| | 03.8857.40ACB |
| | 03.8857.14ACB |
| | Non Dimmable |
| | 05.1045.40A |
| | 05.1045.14A |
| | Dali Version |
| | 05.1045.40ADA |
| | 05.1045.14ADA |
| | Mains Dimming |
| | 05.1045.40ANI |
| | 05.1045.14ANI |
| | Casambi |
| | 05.1045.40ACB |
| | 05.1045.14ACB |
| | Non Dimmable |
| | 05.1046.40A |
| | 05.1046.14A |
| | Dali Version |
| | 05.1046.40ADA |
| | 05.1046.14ADA |
| | Mains Dimming |
| | 05.1046.40ANI |
| | 05.1046.14ANI |
| | Casambi |
| | 05.1046.40ACB |
| | 05.1046.14ACB |
| | Non Dimmable |
| | 05.1047.40A |
| | 05.1047.14A |
| | Dali Version |
| | 05.1047.40ADA |
| | 05.1047.14ADA |
| | Mains Dimming |
| | 05.1047.40ANI |
| | 05.1047.14ANI |
| | Casambi |
| | 05.1047.40ACB |
| | 05.1047.14ACB |



**Optic Medium
2700K**

-  Non Dimmable
03.9200.40A
03.9200.14A
Dali Version
-  03.9200.40ADA
03.9200.14ADA
Mains Dimming
-  03.9200.40ANI
03.9200.14ANI
Casambi
-  03.9200.40ACB
03.9200.14ACB
Non Dimmable
-  03.9201.40A
03.9201.14A
Dali Version
-  03.9201.40ADA
03.9201.14ADA
Mains Dimming
-  03.9201.40ANI
03.9201.14ANI
Casambi
-  03.9201.40ACB
03.9201.14ACB
Non Dimmable
-  05.1050.40A
05.1050.14A
Dali Version
-  05.1050.40ADA
05.1050.14ADA
Mains Dimming
-  05.1050.40ANI
05.1050.14ANI
Casambi
-  05.1050.40ACB
05.1050.14ACB
Non Dimmable
-  05.1051.40A
05.1051.14A
Dali Version
-  05.1051.40ADA
05.1051.14ADA
Mains Dimming
-  05.1051.40ANI
05.1051.14ANI
Casambi
-  05.1051.40ACB
05.1051.14ACB
Non Dimmable
-  05.1052.40A
05.1052.14A
Dali Version
-  05.1052.40ADA
05.1052.14ADA
Mains Dimming
-  05.1052.40ANI
05.1052.14ANI
Casambi
-  05.1052.40ACB
05.1052.14ACB

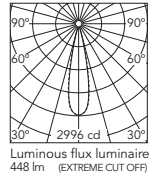





















Beam Angle: 22°

h(m)	E(lx)	D(m)
1	2996	0.39
2	749	0.78
3	333	1.17
4	187	1.56
5	120	1.95

@White (40)

**Optic Medium
3000K**

-  Non Dimmable
03.9210.40A
03.9210.14A
Dali Version
-  03.9210.40ADA
03.9210.14ADA
Mains Dimming
-  03.9210.40ANI
03.9210.14ANI
Casambi
-  03.9210.40ACB
03.9210.14ACB
Non Dimmable
-  03.9211.40A
03.9211.14A
Dali Version
-  03.9211.40ADA
03.9211.14ADA
Mains Dimming
-  03.9211.40ANI
03.9211.14ANI
Casambi
-  03.9211.40ACB
03.9211.14ACB
Non Dimmable
-  05.1055.40A
05.1055.14A
Dali Version
-  05.1055.40ADA
05.1055.14ADA
Mains Dimming
-  05.1055.40ANI
05.1055.14ANI
Casambi
-  05.1055.40ACB
05.1055.14ACB
Non Dimmable
-  05.1056.40A
05.1056.14A
Dali Version
-  05.1056.40ADA
05.1056.14ADA
Mains Dimming
-  05.1056.40ANI
05.1056.14ANI
Casambi
-  05.1056.40ACB
05.1056.14ACB
Non Dimmable
-  05.1057.40A
05.1057.14A
Dali Version
-  05.1057.40ADA
05.1057.14ADA
Mains Dimming
-  05.1057.40ANI
05.1057.14ANI
Casambi
-  05.1057.40ACB
05.1057.14ACB

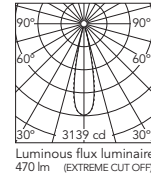

Beam Angle: 22°

h(m)	E(lx)	D(m)
1	3139	0.39
2	785	0.78
3	349	1.17
4	196	1.56
5	126	1.95

@White (40)

LIGHT SHADOW

Light Shadow Fixed No Trim 2 Spots

Light Source: Power LED DC 900 mA 5,4W - 540 lm - 2700K/CRI 90 / 5,4W - 570 lm - 3000K/CRI 90

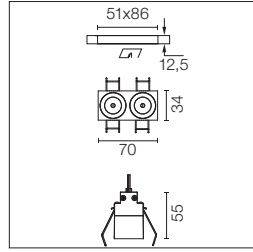

- GWT 850°
- IP 55
- 0,25 Kg
- EneC 03
- F
- h=150 mm
- TECEE
- 10 - 100%
- CE
- DALI
- LED INCL

Leuchte für Unterputzmontage mit 2 LED-Lichtquellen. Externes Netzgerät eingeschlossen (220-240V). Vorinstallationsrahmen. Muss separat bestellt werden.

Recessed integrated luminaire with 2 LED lighting spots. Remote power supply included (220-240V). It requires a pre-installation frame, to be ordered separately.

E= Außenfarbe
I= Innenfarbe

E= External Finish
I= Internal Finish

Optic Flood 2700K

- | | |
|--|---------------|
| | Non Dimmable |
| | 03.9205.40A |
| | 03.9205.14A |
| | Dali Version |
| | 03.9205.40ADA |
| | 03.9205.14ADA |
| | Mains Dimming |
| | 03.9205.40ANI |
| | 03.9205.14ANI |
| | Casambi |
| | 03.9205.40ACB |
| | 03.9205.14ACB |
| | Non Dimmable |
| | 03.9206.40A |
| | 03.9206.14A |
| | Dali Version |
| | 03.9206.40ADA |
| | 03.9206.14ADA |
| | Mains Dimming |
| | 03.9206.40ANI |
| | 03.9206.14ANI |
| | Casambi |
| | 03.9206.40ACB |
| | 03.9206.14ACB |
| | Non Dimmable |
| | 05.1060.40A |
| | 05.1060.14A |
| | Dali Version |
| | 05.1060.40ADA |
| | 05.1060.14ADA |
| | Mains Dimming |
| | 05.1060.40ANI |
| | 05.1060.14ANI |
| | Casambi |
| | 05.1060.40ACB |
| | 05.1060.14ACB |
| | Non Dimmable |
| | 05.1061.40A |
| | 05.1061.14A |
| | Dali Version |
| | 05.1061.40ADA |
| | 05.1061.14ADA |
| | Mains Dimming |
| | 05.1061.40ANI |
| | 05.1061.14ANI |
| | Casambi |
| | 05.1061.40ACB |
| | 05.1061.14ACB |
| | Non Dimmable |
| | 05.1062.40A |
| | 05.1062.14A |
| | Dali Version |
| | 05.1062.40ADA |
| | 05.1062.14ADA |
| | Mains Dimming |
| | 05.1062.40ANI |
| | 05.1062.14ANI |
| | Casambi |
| | 05.1062.40ACB |
| | 05.1062.14ACB |

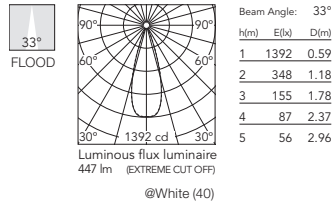





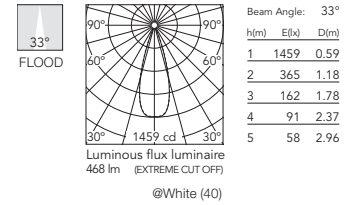



































Optic Flood 3000K

- | | |
|--|---------------|
| | Non Dimmable |
| | 03.9215.40A |
| | 03.9215.14A |
| | Dali Version |
| | 03.9215.40ADA |
| | 03.9215.14ADA |
| | Mains Dimming |
| | 03.9215.40ANI |
| | 03.9215.14ANI |
| | Casambi |
| | 03.9215.40ACB |
| | 03.9215.14ACB |
| | Non Dimmable |
| | 03.9216.40A |
| | 03.9216.14A |
| | Dali Version |
| | 03.9216.40ADA |
| | 03.9216.14ADA |
| | Mains Dimming |
| | 03.9216.40ANI |
| | 03.9216.14ANI |
| | Casambi |
| | 03.9216.40ACB |
| | 03.9216.14ACB |
| | Non Dimmable |
| | 05.1065.40A |
| | 05.1065.14A |
| | Dali Version |
| | 05.1065.40ADA |
| | 05.1065.14ADA |
| | Mains Dimming |
| | 05.1065.40ANI |
| | 05.1065.14ANI |
| | Casambi |
| | 05.1065.40ACB |
| | 05.1065.14ACB |
| | Non Dimmable |
| | 05.1066.40A |
| | 05.1066.14A |
| | Dali Version |
| | 05.1066.40ADA |
| | 05.1066.14ADA |
| | Mains Dimming |
| | 05.1066.40ANI |
| | 05.1066.14ANI |
| | Casambi |
| | 05.1066.40ACB |
| | 05.1066.14ACB |
| | Non Dimmable |
| | 05.1067.40A |
| | 05.1067.14A |
| | Dali Version |
| | 05.1067.40ADA |
| | 05.1067.14ADA |
| | Mains Dimming |
| | 05.1067.40ANI |
| | 05.1067.14ANI |
| | Casambi |
| | 05.1067.40ACB |
| | 05.1067.14ACB |







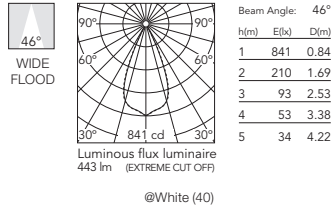



































Optic Wide Flood 2700K

-  Non Dimmable
-  03.8350.40A
-  03.8350.14A
- Dali Version
-  03.8350.40ADA
-  03.8350.14ADA
- Mains Dimming
-  03.8350.40ANI
-  03.8350.14ANI
- Casambi
-  03.8350.40ACB
-  03.8350.14ACB
- Non Dimmable
-  03.8351.40A
-  03.8351.14A
- Dali Version
-  03.8351.40ADA
-  03.8351.14ADA
- Mains Dimming
-  03.8351.40ANI
-  03.8351.14ANI
- Casambi
-  03.8351.40ACB
-  03.8351.14ACB
- Non Dimmable
-  05.1070.40A
-  05.1070.14A
- Dali Version
-  05.1070.40ADA
-  05.1070.14ADA
- Mains Dimming
-  05.1070.40ANI
-  05.1070.14ANI
- Casambi
-  05.1070.40ACB
-  05.1070.14ACB
- Non Dimmable
-  05.1071.40A
-  05.1071.14A
- Dali Version
-  05.1071.40ADA
-  05.1071.14ADA
- Mains Dimming
-  05.1071.40ANI
-  05.1071.14ANI
- Casambi
-  05.1071.40ACB
-  05.1071.14ACB
- Non Dimmable
-  05.1072.40A
-  05.1072.14A
- Dali Version
-  05.1072.40ADA
-  05.1072.14ADA
- Mains Dimming
-  05.1072.40ANI
-  05.1072.14ANI
- Casambi
-  05.1072.40ACB
-  05.1072.14ACB



Optic Wide Flood 3000K

-  Non Dimmable
-  03.8354.40A
-  03.8354.14A
- Dali Version
-  03.8354.40ADA
-  03.8354.14ADA
- Mains Dimming
-  03.8354.40ANI
-  03.8354.14ANI
- Casambi
-  03.8354.40ACB
-  03.8354.14ACB
- Non Dimmable
-  03.8355.40A
-  03.8355.14A
- Dali Version
-  03.8355.40ADA
-  03.8355.14ADA
- Mains Dimming
-  03.8355.40ANI
-  03.8355.14ANI
- Casambi
-  03.8355.40ACB
-  03.8355.14ACB
- Non Dimmable
-  05.1075.40A
-  05.1075.14A
- Dali Version
-  05.1075.40ADA
-  05.1075.14ADA
- Mains Dimming
-  05.1075.40ANI
-  05.1075.14ANI
- Casambi
-  05.1075.40ACB
-  05.1075.14ACB
- Non Dimmable
-  05.1076.40A
-  05.1076.14A
- Dali Version
-  05.1076.40ADA
-  05.1076.14ADA
- Mains Dimming
-  05.1076.40ANI
-  05.1076.14ANI
- Casambi
-  05.1076.40ACB
-  05.1076.14ACB
- Non Dimmable
-  05.1077.40A
-  05.1077.14A
- Dali Version
-  05.1077.40ADA
-  05.1077.14ADA
- Mains Dimming
-  05.1077.40ANI
-  05.1077.14ANI
- Casambi
-  05.1077.40ACB
-  05.1077.14ACB

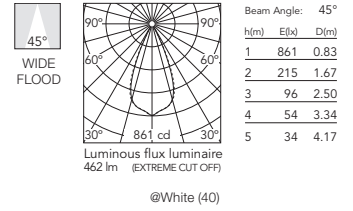

LIGHT SHADOW

Light Shadow Fixed No Trim 4 Spots

Light Source: Power LED DC 900 mA 10,8W - 1080 lm - 2700K/CRI 90 / 10,8W - 1140lm - 3000K/CRI 90

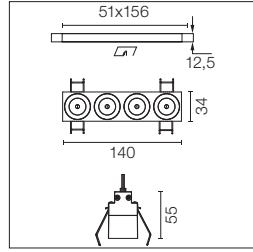

	GWT 850°		IP 55
	0,34 Kg		03
	h=75 min		TECEE
	CE		10 - 100%
	DALI		LED INCL

Leuchte für Unterputzmontage mit 4 LED-Lichtquellen. Externes Netzgerät eingeschlossen (220-240V). Vorinstallationsrahmen. Muss separat bestellt werden.

Recessed integrated luminaire with 4 LED lighting spots. Remote power supply included (220-240V). It requires a pre-installation frame, to be ordered separately.

E= Außenfarbe
I= Innenfarbe

E= External Finish
I= Internal Finish

Optic Spot 2700K

- | | |
|--|---------------|
| | Non Dimmable |
| | 03.8860.40A |
| | 03.8860.14A |
| | Dali Version |
| | 03.8860.40ADA |
| | 03.8860.14ADA |
| | Mains Dimming |
| | 03.8860.40ANI |
| | 03.8860.14ANI |
| | Casambi |
| | 03.8860.40ACB |
| | 03.8860.14ACB |
| | Non Dimmable |
| | 03.8861.40A |
| | 03.8861.14A |
| | Dali Version |
| | 03.8861.40ADA |
| | 03.8861.14ADA |
| | Mains Dimming |
| | 03.8861.40ANI |
| | 03.8861.14ANI |
| | Casambi |
| | 03.8861.40ACB |
| | 03.8861.14ACB |
| | Non Dimmable |
| | 05.1140.40A |
| | 05.1140.14A |
| | Dali Version |
| | 05.1140.40ADA |
| | 05.1140.14ADA |
| | Mains Dimming |
| | 05.1140.40ANI |
| | 05.1140.14ANI |
| | Casambi |
| | 05.1140.40ACB |
| | 05.1140.14ACB |
| | Non Dimmable |
| | 05.1141.40A |
| | 05.1141.14A |
| | Dali Version |
| | 05.1141.40ADA |
| | 05.1141.14ADA |
| | Mains Dimming |
| | 05.1141.40ANI |
| | 05.1141.14ANI |
| | Casambi |
| | 05.1141.40ACB |
| | 05.1141.14ACB |
| | Non Dimmable |
| | 05.1142.40A |
| | 05.1142.14A |
| | Dali Version |
| | 05.1142.40ADA |
| | 05.1142.14ADA |
| | Mains Dimming |
| | 05.1142.40ANI |
| | 05.1142.14ANI |
| | Casambi |
| | 05.1142.40ACB |
| | 05.1142.14ACB |

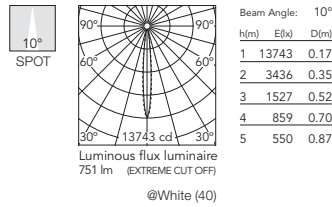





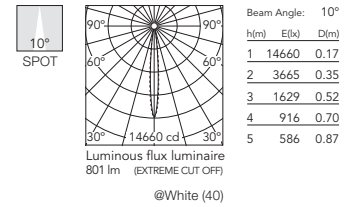















Optic Spot 3000K

- | | |
|--|---------------|
| | Non Dimmable |
| | 03.8864.40A |
| | 03.8864.14A |
| | Dali Version |
| | 03.8864.40ADA |
| | 03.8864.14ADA |
| | Mains Dimming |
| | 03.8864.40ANI |
| | 03.8864.14ANI |
| | Casambi |
| | 03.8864.40ACB |
| | 03.8864.14ACB |
| | Non Dimmable |
| | 03.8865.40A |
| | 03.8865.14A |
| | Dali Version |
| | 03.8865.40ADA |
| | 03.8865.14ADA |
| | Mains Dimming |
| | 03.8865.40ANI |
| | 03.8865.14ANI |
| | Casambi |
| | 03.8865.40ACB |
| | 03.8865.14ACB |
| | Non Dimmable |
| | 05.1145.40A |
| | 05.1145.14A |
| | Dali Version |
| | 05.1145.40ADA |
| | 05.1145.14ADA |
| | Mains Dimming |
| | 05.1145.40ANI |
| | 05.1145.14ANI |
| | Casambi |
| | 05.1145.40ACB |
| | 05.1145.14ACB |
| | Non Dimmable |
| | 05.1146.40A |
| | 05.1146.14A |
| | Dali Version |
| | 05.1146.40ADA |
| | 05.1146.14ADA |
| | Mains Dimming |
| | 05.1146.40ANI |
| | 05.1146.14ANI |
| | Casambi |
| | 05.1146.40ACB |
| | 05.1146.14ACB |
| | Non Dimmable |
| | 05.1147.40A |
| | 05.1147.14A |
| | Dali Version |
| | 05.1147.40ADA |
| | 05.1147.14ADA |
| | Mains Dimming |
| | 05.1147.40ANI |
| | 05.1147.14ANI |
| | Casambi |
| | 05.1147.40ACB |
| | 05.1147.14ACB |







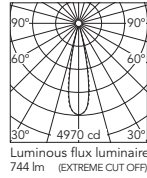















**Optic Medium
2700K**

-  Non Dimmable
03.9220.40A
03.9220.14A
Dali Version
-  03.9220.40ADA
03.9220.14ADA
Mains Dimming
-  03.9220.40ANI
03.9220.14ANI
Casambi
-  03.9220.40ACB
03.9220.14ACB
Non Dimmable
-  03.9221.40A
03.9221.14A
Dali Version
-  03.9221.40ADA
03.9221.14ADA
Mains Dimming
-  03.9221.40ANI
03.9221.14ANI
Casambi
-  03.9221.40ACB
03.9221.14ACB
Non Dimmable
-  05.1150.40A
05.1150.14A
Dali Version
-  05.1150.40ADA
05.1150.14ADA
Mains Dimming
-  05.1150.40ANI
05.1150.14ANI
Casambi
-  05.1150.40ACB
05.1150.14ACB
Non Dimmable
-  05.1151.40A
05.1151.14A
Dali Version
-  05.1151.40ADA
05.1151.14ADA
Mains Dimming
-  05.1151.40ANI
05.1151.14ANI
Casambi
-  05.1151.40ACB
05.1151.14ACB
Non Dimmable
-  05.1152.40A
05.1152.14A
Dali Version
-  05.1152.40ADA
05.1152.14ADA
Mains Dimming
-  05.1152.40ANI
05.1152.14ANI
Casambi
-  05.1152.40ACB
05.1152.14ACB



h(m)	E(lx)	D(m)
1	4970	0.39
2	1243	0.78
3	552	1.17
4	311	1.56
5	199	1.95

**Optic Medium
3000K**

-  Non Dimmable
03.9230.40A
03.9230.14A
Dali Version
-  03.9230.40ADA
03.9230.14ADA
Mains Dimming
-  03.9230.40ANI
03.9230.14ANI
Casambi
-  03.9230.40ACB
03.9230.14ACB
Non Dimmable
-  03.9231.40A
03.9231.14A
Dali Version
-  03.9231.40ADA
03.9231.14ADA
Mains Dimming
-  03.9231.40ANI
03.9231.14ANI
Casambi
-  03.9231.40ACB
03.9231.14ACB
Non Dimmable
-  05.1155.40A
05.1155.14A
Dali Version
-  05.1155.40ADA
05.1155.14ADA
Mains Dimming
-  05.1155.40ANI
05.1155.14ANI
Casambi
-  05.1155.40ACB
05.1155.14ACB
Non Dimmable
-  05.1156.40A
05.1156.14A
Dali Version
-  05.1156.40ADA
05.1156.14ADA
Mains Dimming
-  05.1156.40ANI
05.1156.14ANI
Casambi
-  05.1156.40ACB
05.1156.14ACB
Non Dimmable
-  05.1157.40A
05.1157.14A
Dali Version
-  05.1157.40ADA
05.1157.14ADA
Mains Dimming
-  05.1157.40ANI
05.1157.14ANI
Casambi
-  05.1157.40ACB
05.1157.14ACB

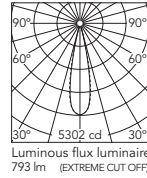

h(m)	E(lx)	D(m)
1	5302	0.39
2	1325	0.78
3	589	1.17
4	331	1.56
5	212	1.95

LIGHT SHADOW

Light Shadow Fixed No Trim 4 Spots

Light Source: Power LED DC 900 mA 10,8W - 1080 lm - 2700K/CRI 90 / 10,8W - 1140lm - 3000K/CRI 90

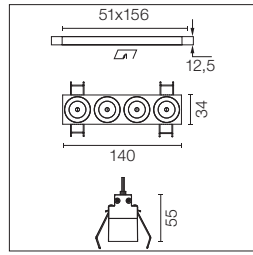

- GWT 850°
- IP 55
- 0,34 Kg
- 03
- F
- h=75 min
- TECEE
- 10-100%
- DALI
- LED INCL
- CE
-
-

Leuchte für Unterputzmontage mit 4 LED-Lichtquellen. Externes Netzgerät eingeschlossen (220-240V). Vorinstallationsrahmen. Muss separat bestellt werden.

Recessed integrated luminaire with 4 LED lighting spots. Remote power supply included (220-240V). It requires a pre-installation frame, to be ordered separately.

E= Außenfarbe
I= Innenfarbe

E= External Finish
I= Internal Finish

Optic Flood 2700K

- | | |
|--|---------------|
| | Non Dimmable |
| | 03.9225.40A |
| | 03.9225.14A |
| | Dali Version |
| | 03.9225.40ADA |
| | 03.9225.14ADA |
| | Mains Dimming |
| | 03.9225.40ANI |
| | 03.9225.14ANI |
| | Casambi |
| | 03.9225.40ACB |
| | 03.9225.14ACB |
| | Non Dimmable |
| | 03.9226.40A |
| | 03.9226.14A |
| | Dali Version |
| | 03.9226.40ADA |
| | 03.9226.14ADA |
| | Mains Dimming |
| | 03.9226.40ANI |
| | 03.9226.14ANI |
| | Casambi |
| | 03.9226.40ACB |
| | 03.9226.14ACB |
| | Non Dimmable |
| | 05.1160.40A |
| | 05.1160.14A |
| | Dali Version |
| | 05.1160.40ADA |
| | 05.1160.14ADA |
| | Mains Dimming |
| | 05.1160.40ANI |
| | 05.1160.14ANI |
| | Casambi |
| | 05.1160.40ACB |
| | 05.1160.14ACB |
| | Non Dimmable |
| | 05.1161.40A |
| | 05.1161.14A |
| | Dali Version |
| | 05.1161.40ADA |
| | 05.1161.14ADA |
| | Mains Dimming |
| | 05.1161.40ANI |
| | 05.1161.14ANI |
| | Casambi |
| | 05.1161.40ACB |
| | 05.1161.14ACB |
| | Non Dimmable |
| | 05.1162.40A |
| | 05.1162.14A |
| | Dali Version |
| | 05.1162.40ADA |
| | 05.1162.14ADA |
| | Mains Dimming |
| | 05.1162.40ANI |
| | 05.1162.14ANI |
| | Casambi |
| | 05.1162.40ACB |
| | 05.1162.14ACB |

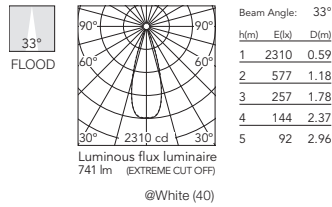





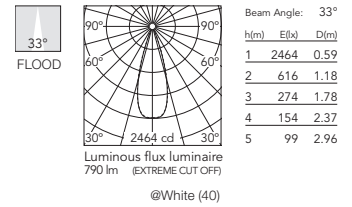















Optic Flood 3000K

- | | |
|--|---------------|
| | Non Dimmable |
| | 03.9235.40A |
| | 03.9235.14A |
| | Dali Version |
| | 03.9235.40ADA |
| | 03.9235.14ADA |
| | Mains Dimming |
| | 03.9235.40ANI |
| | 03.9235.14ANI |
| | Casambi |
| | 03.9235.40ACB |
| | 03.9235.14ACB |
| | Non Dimmable |
| | 03.9236.40A |
| | 03.9236.14A |
| | Dali Version |
| | 03.9236.40ADA |
| | 03.9236.14ADA |
| | Mains Dimming |
| | 03.9236.40ANI |
| | 03.9236.14ANI |
| | Casambi |
| | 03.9236.40ACB |
| | 03.9236.14ACB |
| | Non Dimmable |
| | 05.1165.40A |
| | 05.1165.14A |
| | Dali Version |
| | 05.1165.40ADA |
| | 05.1165.14ADA |
| | Mains Dimming |
| | 05.1165.40ANI |
| | 05.1165.14ANI |
| | Casambi |
| | 05.1165.40ACB |
| | 05.1165.14ACB |
| | Non Dimmable |
| | 05.1166.40A |
| | 05.1166.14A |
| | Dali Version |
| | 05.1166.40ADA |
| | 05.1166.14ADA |
| | Mains Dimming |
| | 05.1166.40ANI |
| | 05.1166.14ANI |
| | Casambi |
| | 05.1166.40ACB |
| | 05.1166.14ACB |
| | Non Dimmable |
| | 05.1167.40A |
| | 05.1167.14A |
| | Dali Version |
| | 05.1167.40ADA |
| | 05.1167.14ADA |
| | Mains Dimming |
| | 05.1167.40ANI |
| | 05.1167.14ANI |
| | Casambi |
| | 05.1167.40ACB |
| | 05.1167.14ACB |



**Optic Wide Flood
2700K**

-  Non Dimmable
03.8358.40A
03.8358.14A
Dali Version
-  03.8358.40ADA
03.8358.14ADA
Mains Dimming
-  03.8358.40ANI
03.8358.14ANI
Casambi
-  03.8358.40ACB
03.8358.14ACB
Non Dimmable
-  03.8359.40A
03.8359.14A
Dali Version
-  03.8359.40ADA
03.8359.14ADA
Mains Dimming
-  03.8359.40ANI
03.8359.14ANI
Casambi
-  03.8359.40ACB
03.8359.14ACB
Non Dimmable
-  05.1170.40A
05.1170.14A
Dali Version
-  05.1170.40ADA
05.1170.14ADA
Mains Dimming
-  05.1170.40ANI
05.1170.14ANI
Casambi
-  05.1170.40ACB
05.1170.14ACB
Non Dimmable
-  05.1171.40A
05.1171.14A
Dali Version
-  05.1171.40ADA
05.1171.14ADA
Mains Dimming
-  05.1171.40ANI
05.1171.14ANI
Casambi
-  05.1171.40ACB
05.1171.14ACB
Non Dimmable
-  05.1172.40A
05.1172.14A
Dali Version
-  05.1172.40ADA
05.1172.14ADA
Mains Dimming
-  05.1172.40ANI
05.1172.14ANI
Casambi
-  05.1172.40ACB
05.1172.14ACB

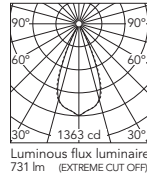





















Beam Angle: 45°

h(m)	E(lx)	D(m)
1	1363	0.83
2	341	1.67
3	151	2.50
4	85	3.34
5	55	4.17

@White (40)

**Optic Wide Flood
3000K**

-  Non Dimmable
03.8362.40A
03.8362.14A
Dali Version
-  03.8362.40ADA
03.8362.14ADA
Mains Dimming
-  03.8362.40ANI
03.8362.14ANI
Casambi
-  03.8362.40ACB
03.8362.14ACB
Non Dimmable
-  03.8363.40A
03.8363.14A
Dali Version
-  03.8363.40ADA
03.8363.14ADA
Mains Dimming
-  03.8363.40ANI
03.8363.14ANI
Casambi
-  03.8363.40ACB
03.8363.14ACB
Non Dimmable
-  05.1175.40A
05.1175.14A
Dali Version
-  05.1175.40ADA
05.1175.14ADA
Mains Dimming
-  05.1175.40ANI
05.1175.14ANI
Casambi
-  05.1175.40ACB
05.1175.14ACB
Non Dimmable
-  05.1176.40A
05.1176.14A
Dali Version
-  05.1176.40ADA
05.1176.14ADA
Mains Dimming
-  05.1176.40ANI
05.1176.14ANI
Casambi
-  05.1176.40ACB
05.1176.14ACB
Non Dimmable
-  05.1177.40A
05.1177.14A
Dali Version
-  05.1177.40ADA
05.1177.14ADA
Mains Dimming
-  05.1177.40ANI
05.1177.14ANI
Casambi
-  05.1177.40ACB
05.1177.14ACB

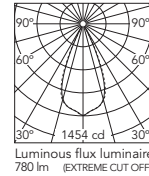

Beam Angle: 45°

h(m)	E(lx)	D(m)
1	1454	0.83
2	363	1.67
3	162	2.50
4	91	3.34
5	58	4.17

@White (40)

LIGHT SHADOW

Light Shadow Fixed No Trim 4 Spots Square

Light Source: Power LED DC 900 mA 10,8W - 1080 lm - 2700K/CRI 90 / 10,8W - 1140lm - 3000K/CRI 90

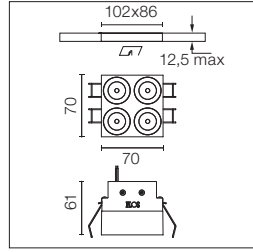

- GWT 850°
- TECEE
- DALI
- LED INCL
- CE
- IP 55

Leuchte für Unterputzmontage mit 4 LED-Lichtquellen. Externes Netzgerät eingeschlossen (220-240V). Vorinstallationsrahmen. Muss separat bestellt werden.

Recessed integrated luminaire with 4 LED lighting spots. Remote power supply included (220-240V). It requires a pre-installation frame, to be ordered separately.

E= Außenfarbe
I= Innenfarbe

E= External Finish
I= Internal Finish

Optic Spot 2700K

- | | |
|--|---------------|
| | Non Dimmable |
| | 05.0640.40 |
| | 05.0640.14 |
| | Dali Version |
| | 05.0640.40.DA |
| | 05.0640.14.DA |
| | Mains Dimming |
| | 05.0640.40.NI |
| | 05.0640.14.NI |
| | Casambi |
| | 05.0640.40.CB |
| | 05.0640.14.CB |
| | Non Dimmable |
| | 05.0641.40 |
| | 05.0641.14 |
| | Dali Version |
| | 05.0641.40.DA |
| | 05.0641.14.DA |
| | Mains Dimming |
| | 05.0641.40.NI |
| | 05.0641.14.NI |
| | Casambi |
| | 05.0641.40.CB |
| | 05.0641.14.CB |
| | Non Dimmable |
| | 05.0643.40 |
| | 05.0643.14 |
| | Dali Version |
| | 05.0643.40.DA |
| | 05.0643.14.DA |
| | Mains Dimming |
| | 05.0643.40.NI |
| | 05.0643.14.NI |
| | Casambi |
| | 05.0643.40.CB |
| | 05.0643.14.CB |
| | Non Dimmable |
| | 05.0644.40 |
| | 05.0644.14 |
| | Dali Version |
| | 05.0644.40.DA |
| | 05.0644.14.DA |
| | Mains Dimming |
| | 05.0644.40.NI |
| | 05.0644.14.NI |
| | Casambi |
| | 05.0644.40.CB |
| | 05.0644.14.CB |
| | Non Dimmable |
| | 05.0642.40 |
| | 05.0642.14 |
| | Dali Version |
| | 05.0642.40.DA |
| | 05.0642.14.DA |
| | Mains Dimming |
| | 05.0642.40.NI |
| | 05.0642.14.NI |
| | Casambi |
| | 05.0642.40.CB |
| | 05.0642.14.CB |

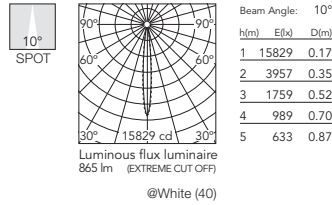





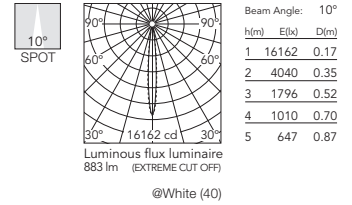



























Optic Spot 3000K

- | | |
|--|---------------|
| | Non Dimmable |
| | 05.0645.40 |
| | 05.0645.14 |
| | Dali Version |
| | 05.0645.40.DA |
| | 05.0645.14.DA |
| | Mains Dimming |
| | 05.0645.40.NI |
| | 05.0645.14.NI |
| | Casambi |
| | 05.0645.40.CB |
| | 05.0645.14.CB |
| | Non Dimmable |
| | 05.0646.40 |
| | 05.0646.14 |
| | Dali Version |
| | 05.0646.40.DA |
| | 05.0646.14.DA |
| | Mains Dimming |
| | 05.0646.40.NI |
| | 05.0646.14.NI |
| | Casambi |
| | 05.0646.40.CB |
| | 05.0646.14.CB |
| | Non Dimmable |
| | 05.0648.40 |
| | 05.0648.14 |
| | Dali Version |
| | 05.0648.40.DA |
| | 05.0648.14.DA |
| | Mains Dimming |
| | 05.0648.40.NI |
| | 05.0648.14.NI |
| | Casambi |
| | 05.0648.40.CB |
| | 05.0648.14.CB |
| | Non Dimmable |
| | 05.0649.40 |
| | 05.0649.14 |
| | Dali Version |
| | 05.0649.40.DA |
| | 05.0649.14.DA |
| | Mains Dimming |
| | 05.0649.40.NI |
| | 05.0649.14.NI |
| | Casambi |
| | 05.0649.40.CB |
| | 05.0649.14.CB |
| | Non Dimmable |
| | 05.0647.40 |
| | 05.0647.14 |
| | Dali Version |
| | 05.0647.40.DA |
| | 05.0647.14.DA |
| | Mains Dimming |
| | 05.0647.40.NI |
| | 05.0647.14.NI |
| | Casambi |
| | 05.0647.40.CB |
| | 05.0647.14.CB |



**Optic Medium
2700K**

- | | |
|--|---------------|
|  | Non Dimmable |
|  | 05.0650.40 |
|  | 05.0650.14 |
| | Dali Version |
|  | 05.0650.40.DA |
|  | 05.0650.14.DA |
| | Mains Dimming |
|  | 05.0650.40.NI |
|  | 05.0650.14.NI |
| | Casambi |
|  | 05.0650.40.CB |
|  | 05.0650.14.CB |
| | Non Dimmable |
|  | 05.0651.40 |
|  | 05.0651.14 |
| | Dali Version |
|  | 05.0651.40.DA |
|  | 05.0651.14.DA |
| | Mains Dimming |
|  | 05.0651.40.NI |
|  | 05.0651.14.NI |
| | Casambi |
|  | 05.0651.40.CB |
|  | 05.0651.14.CB |
| | Non Dimmable |
|  | 05.0653.40 |
|  | 05.0653.14 |
| | Dali Version |
|  | 05.0653.40.DA |
|  | 05.0653.14.DA |
| | Mains Dimming |
|  | 05.0653.40.NI |
|  | 05.0653.14.NI |
| | Casambi |
|  | 05.0653.40.CB |
|  | 05.0653.14.CB |
| | Non Dimmable |
|  | 05.0654.40 |
|  | 05.0654.14 |
| | Dali Version |
|  | 05.0654.40.DA |
|  | 05.0654.14.DA |
| | Mains Dimming |
|  | 05.0654.40.NI |
|  | 05.0654.14.NI |
| | Casambi |
|  | 05.0654.40.CB |
|  | 05.0654.14.CB |

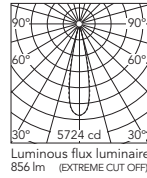



































Beam Angle: 22°

	h(m)	E(lx)	D(m)
1	5724	0.39	
2	1431	0.78	
3	636	1.17	
4	358	1.56	
5	229	1.95	

@White (40)

**Optic Medium
3000K**

- | | |
|---|---------------|
|  | Non Dimmable |
|  | 05.0655.40 |
|  | 05.0655.14 |
| | Dali Version |
|  | 05.0655.40.DA |
|  | 05.0655.14.DA |
| | Mains Dimming |
|  | 05.0655.40.NI |
|  | 05.0655.14.NI |
| | Casambi |
|  | 05.0655.40.CB |
|  | 05.0655.14.CB |
| | Non Dimmable |
|  | 05.0656.40 |
|  | 05.0656.14 |
| | Dali Version |
|  | 05.0656.40.DA |
|  | 05.0656.14.DA |
| | Mains Dimming |
|  | 05.0656.40.NI |
|  | 05.0656.14.NI |
| | Casambi |
|  | 05.0656.40.CB |
|  | 05.0656.14.CB |
| | Non Dimmable |
|  | 05.0658.40 |
|  | 05.0658.14 |
| | Dali Version |
|  | 05.0658.40.DA |
|  | 05.0658.14.DA |
| | Mains Dimming |
|  | 05.0658.40.NI |
|  | 05.0658.14.NI |
| | Casambi |
|  | 05.0658.40.CB |
|  | 05.0658.14.CB |
| | Non Dimmable |
|  | 05.0659.40 |
|  | 05.0659.14 |
| | Dali Version |
|  | 05.0659.40.DA |
|  | 05.0659.14.DA |
| | Mains Dimming |
|  | 05.0659.40.NI |
|  | 05.0659.14.NI |
| | Casambi |
|  | 05.0659.40.CB |
|  | 05.0659.14.CB |
| | Non Dimmable |
|  | 05.0657.40 |
| | 05.0657.14 |
| | Dali Version |
| | 05.0657.40.DA |
| | 05.0657.14.DA |
| | Mains Dimming |
| | 05.0657.40.NI |
| | 05.0657.14.NI |
| | Casambi |
| | 05.0657.40.CB |
| | 05.0657.14.CB |

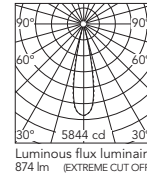

Beam Angle: 22°

	h(m)	E(lx)	D(m)
1	5844	0.39	
2	1461	0.78	
3	650	1.17	
4	365	1.56	
5	233	1.95	

@White (40)

LIGHT SHADOW

Light Shadow Fixed No Trim 4 Spots Square

Light Source: Power LED DC 900 mA 10,8W - 1080 lm - 2700K/CRI 90 / 10,8W - 1140lm - 3000K/CRI 90

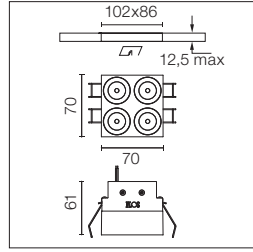

- GWT 850°
- 0,34 Kg
- CECEE
- DALI
- LED INCL
- IP 55
- h=75 min
- CE

Leuchte für Unterputzmontage mit 4 LED-Lichtquellen. Externes Netzgerät eingeschlossen (220-240V). Vorinstallationsrahmen. Muss separat bestellt werden.

Recessed integrated luminaire with 4 LED lighting spots. Remote power supply included (220-240V). It requires a pre-installation frame, to be ordered separately.

E= Außenfarbe
I= Innenfarbe

E= External Finish
I= Internal Finish

Optic Flood 2700K

- | | |
|--|---------------|
| | Non Dimmable |
| | 05.0660.40 |
| | 05.0660.14 |
| | Dali Version |
| | 05.0660.40.DA |
| | 05.0660.14.DA |
| | Mains Dimming |
| | 05.0660.40.NI |
| | 05.0660.14.NI |
| | Casambi |
| | 05.0660.40.CB |
| | 05.0660.14.CB |
| | Non Dimmable |
| | 05.0661.40 |
| | 05.0661.14 |
| | Dali Version |
| | 05.0661.40.DA |
| | 05.0661.14.DA |
| | Mains Dimming |
| | 05.0661.40.NI |
| | 05.0661.14.NI |
| | Casambi |
| | 05.0661.40.CB |
| | 05.0661.14.CB |
| | Non Dimmable |
| | 05.0663.40 |
| | 05.0663.14 |
| | Dali Version |
| | 05.0663.40.DA |
| | 05.0663.14.DA |
| | Mains Dimming |
| | 05.0663.40.NI |
| | 05.0663.14.NI |
| | Casambi |
| | 05.0663.40.CB |
| | 05.0663.14.CB |
| | Non Dimmable |
| | 05.0664.40 |
| | 05.0664.14 |
| | Dali Version |
| | 05.0664.40.DA |
| | 05.0664.14.DA |
| | Mains Dimming |
| | 05.0664.40.NI |
| | 05.0664.14.NI |
| | Casambi |
| | 05.0664.40.CB |
| | 05.0664.14.CB |
| | Non Dimmable |
| | 05.0662.40 |
| | 05.0662.14 |
| | Dali Version |
| | 05.0662.40.DA |
| | 05.0662.14.DA |
| | Mains Dimming |
| | 05.0662.40.NI |
| | 05.0662.14.NI |
| | Casambi |
| | 05.0662.40.CB |
| | 05.0662.14.CB |

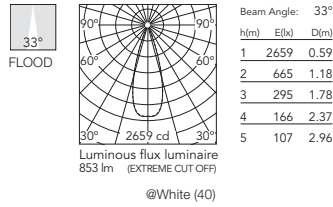





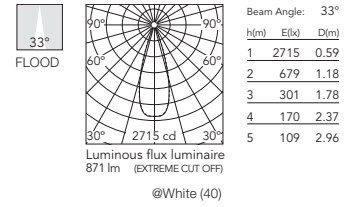















Optic Flood 3000K

- | | |
|--|---------------|
| | Non Dimmable |
| | 05.0665.40 |
| | 05.0665.14 |
| | Dali Version |
| | 05.0665.40.DA |
| | 05.0665.14.DA |
| | Mains Dimming |
| | 05.0665.40.NI |
| | 05.0665.14.NI |
| | Casambi |
| | 05.0665.40.CB |
| | 05.0665.14.CB |
| | Non Dimmable |
| | 05.0666.40 |
| | 05.0666.14 |
| | Dali Version |
| | 05.0666.40.DA |
| | 05.0666.14.DA |
| | Mains Dimming |
| | 05.0666.40.NI |
| | 05.0666.14.NI |
| | Casambi |
| | 05.0666.40.CB |
| | 05.0666.14.CB |
| | Non Dimmable |
| | 05.0668.40 |
| | 05.0668.14 |
| | Dali Version |
| | 05.0668.40.DA |
| | 05.0668.14.DA |
| | Mains Dimming |
| | 05.0668.40.NI |
| | 05.0668.14.NI |
| | Casambi |
| | 05.0668.40.CB |
| | 05.0668.14.CB |
| | Non Dimmable |
| | 05.0669.40 |
| | 05.0669.14 |
| | Dali Version |
| | 05.0669.40.DA |
| | 05.0669.14.DA |
| | Mains Dimming |
| | 05.0669.40.NI |
| | 05.0669.14.NI |
| | Casambi |
| | 05.0669.40.CB |
| | 05.0669.14.CB |
| | Non Dimmable |
| | 05.0667.40 |
| | 05.0667.14 |
| | Dali Version |
| | 05.0667.40.DA |
| | 05.0667.14.DA |
| | Mains Dimming |
| | 05.0667.40.NI |
| | 05.0667.14.NI |
| | Casambi |
| | 05.0667.40.CB |
| | 05.0667.14.CB |







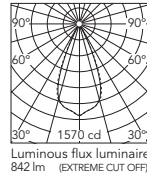















Optic Wide Flood 2700K

-  Non Dimmable
05.0670.40
05.0670.14
-  05.0670.40.DA
05.0670.14.DA
-  05.0670.40.NI
05.0670.14.NI
-  05.0670.40.CB
05.0670.14.CB
-  05.0671.40
05.0671.14
-  05.0671.40.DA
05.0671.14.DA
-  05.0671.40.NI
05.0671.14.NI
-  05.0671.40.CB
05.0671.14.CB
-  05.0673.40
05.0673.14
-  05.0673.40.DA
05.0673.14.DA
-  05.0673.40.NI
05.0673.14.NI
-  05.0673.40.CB
05.0673.14.CB
-  05.0674.40
05.0674.14
-  05.0674.40.DA
05.0674.14.DA
-  05.0674.40.NI
05.0674.14.NI
-  05.0674.40.CB
05.0674.14.CB
-  05.0672.40
05.0672.14
-  05.0672.40.DA
05.0672.14.DA
-  05.0672.40.NI
05.0672.14.NI
-  05.0672.40.CB
05.0672.14.CB



Optic Wide Flood 3000K

-  Non Dimmable
05.0675.40
05.0675.14
-  05.0675.40.DA
05.0675.14.DA
-  05.0675.40.NI
05.0675.14.NI
-  05.0675.40.CB
05.0675.14.CB
-  05.0676.40
05.0676.14
-  05.0676.40.DA
05.0676.14.DA
-  05.0676.40.NI
05.0676.14.NI
-  05.0676.40.CB
05.0676.14.CB
-  05.0678.40
05.0678.14
-  05.0678.40.DA
05.0678.14.DA
-  05.0678.40.NI
05.0678.14.NI
-  05.0678.40.CB
05.0678.14.CB
-  05.0679.40
05.0679.14
-  05.0679.40.DA
05.0679.14.DA
-  05.0679.40.NI
05.0679.14.NI
-  05.0679.40.CB
05.0679.14.CB
-  05.0677.40
05.0677.14
-  05.0677.40.DA
05.0677.14.DA
-  05.0677.40.NI
05.0677.14.NI
-  05.0677.40.CB
05.0677.14.CB

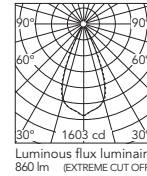

LIGHT SHADOW

Light Shadow Fixed No Trim 8 Spots

Light Source: Power LED DC 900 mA 21,6W - 2160 lm - 2700K/CRI 90 / 21,6W - 2280 lm - 3000K/CRI 90
 Mains dimming: Power LED DC 750 mA 18,5W - 1800 lm - 2700K/CRI 90 / 18,5W - 1900 lm - 3000K/CRI 90

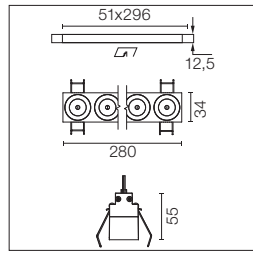

GWT 850°
 IP 55
 0,50 Kg
 Eco
 F
 h=75 min
 TEGEE
 10 - 100%
 CE
 DALI
 LED INCL

Leuchte für Unterputzmontage mit 8 LED-Lichtquellen. Externes Netzgerät eingeschlossen (220-240V). Vorinstallationsrahmen. Muss separat bestellt werden.

Recessed integrated luminaire with 8 LED lighting spots. Remote power supply included (220-240V). It requires a pre-installation frame, to be ordered separately.

E= Außenfarbe
I= Innenfarbe

E= External Finish
I= Internal Finish

Optic Spot 2700K

- | | |
|--|---------------|
| | Non Dimmable |
| | 03.8868.40A |
| | 03.8868.14A |
| | Dali Version |
| | 03.8868.40ADA |
| | 03.8868.14ADA |
| | Mains Dimming |
| | 03.8868.40ANI |
| | 03.8868.14ANI |
| | Casambi |
| | 03.8868.40ACB |
| | 03.8868.14ACB |
| | Non Dimmable |
| | 03.8869.40A |
| | 03.8869.14A |
| | Dali Version |
| | 03.8869.40ADA |
| | 03.8869.14ADA |
| | Mains Dimming |
| | 03.8869.40ANI |
| | 03.8869.14ANI |
| | Casambi |
| | 03.8869.40ACB |
| | 03.8869.14ACB |
| | Non Dimmable |
| | 05.1240.40A |
| | 05.1240.14A |
| | Dali Version |
| | 05.1240.40ADA |
| | 05.1240.14ADA |
| | Mains Dimming |
| | 05.1240.40ANI |
| | 05.1240.14ANI |
| | Casambi |
| | 05.1240.40ACB |
| | 05.1240.14ACB |
| | Non Dimmable |
| | 05.1241.40A |
| | 05.1241.14A |
| | Dali Version |
| | 05.1241.40ADA |
| | 05.1241.14ADA |
| | Mains Dimming |
| | 05.1241.40ANI |
| | 05.1241.14ANI |
| | Casambi |
| | 05.1241.40ACB |
| | 05.1241.14ACB |
| | Non Dimmable |
| | 05.1242.40A |
| | 05.1242.14A |
| | Dali Version |
| | 05.1242.40ADA |
| | 05.1242.14ADA |
| | Mains Dimming |
| | 05.1242.40ANI |
| | 05.1242.14ANI |
| | Casambi |
| | 05.1242.40ACB |
| | 05.1242.14ACB |

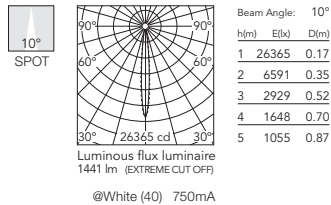
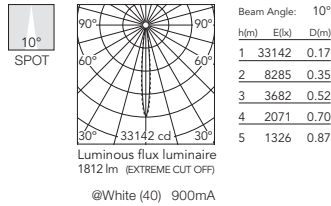





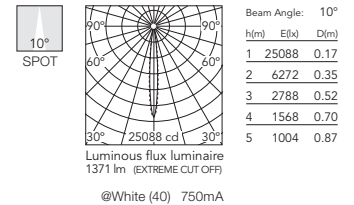
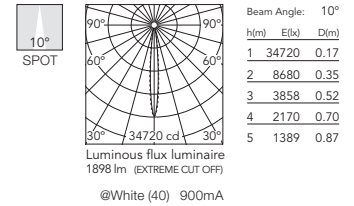















Optic Spot 3000K

- | | |
|--|---------------|
| | Non Dimmable |
| | 03.8872.40A |
| | 03.8872.14A |
| | Dali Version |
| | 03.8872.40ADA |
| | 03.8872.14ADA |
| | Mains Dimming |
| | 03.8872.40ANI |
| | 03.8872.14ANI |
| | Casambi |
| | 03.8872.40ACB |
| | 03.8872.14ACB |
| | Non Dimmable |
| | 03.8873.40A |
| | 03.8873.14A |
| | Dali Version |
| | 03.8873.40ADA |
| | 03.8873.14ADA |
| | Mains Dimming |
| | 03.8873.40ANI |
| | 03.8873.14ANI |
| | Casambi |
| | 03.8873.40ACB |
| | 03.8873.14ACB |
| | Non Dimmable |
| | 05.1245.40A |
| | 05.1245.14A |
| | Dali Version |
| | 05.1245.40ADA |
| | 05.1245.14ADA |
| | Mains Dimming |
| | 05.1245.40ANI |
| | 05.1245.14ANI |
| | Casambi |
| | 05.1245.40ACB |
| | 05.1245.14ACB |
| | Non Dimmable |
| | 05.1246.40A |
| | 05.1246.14A |
| | Dali Version |
| | 05.1246.40ADA |
| | 05.1246.14ADA |
| | Mains Dimming |
| | 05.1246.40ANI |
| | 05.1246.14ANI |
| | Casambi |
| | 05.1246.40ACB |
| | 05.1246.14ACB |
| | Non Dimmable |
| | 05.1247.40A |
| | 05.1247.14A |
| | Dali Version |
| | 05.1247.40ADA |
| | 05.1247.14ADA |
| | Mains Dimming |
| | 05.1247.40ANI |
| | 05.1247.14ANI |
| | Casambi |
| | 05.1247.40ACB |
| | 05.1247.14ACB |







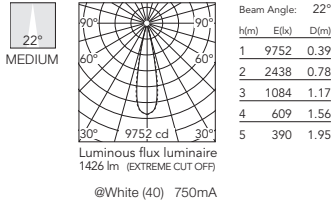
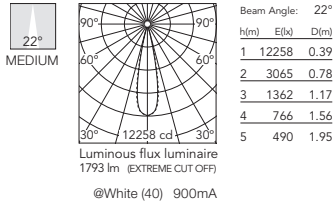















Optic Medium 2700K

-  Non Dimmable
03.9240.40A
03.9240.14A
Dali Version
-  03.9240.40ADA
03.9240.14ADA
Mains Dimming
-  03.9240.40ANI
03.9240.14ANI
Casambi
-  03.9240.40ACB
03.9240.14ACB
Non Dimmable
-  03.9241.40A
03.9241.14A
Dali Version
-  03.9241.40ADA
03.9241.14ADA
Mains Dimming
-  03.9241.40ANI
03.9241.14ANI
Casambi
-  03.9241.40ACB
03.9241.14ACB
Non Dimmable
-  05.1250.40A
05.1250.14A
Dali Version
-  05.1250.40ADA
05.1250.14ADA
Mains Dimming
-  05.1250.40ANI
05.1250.14ANI
Casambi
-  05.1250.40ACB
05.1250.14ACB
Non Dimmable
-  05.1251.40A
05.1251.14A
Dali Version
-  05.1251.40ADA
05.1251.14ADA
Mains Dimming
-  05.1251.40ANI
05.1251.14ANI
Casambi
-  05.1251.40ACB
05.1251.14ACB
Non Dimmable
-  05.1252.40A
05.1252.14A
Dali Version
-  05.1252.40ADA
05.1252.14ADA
Mains Dimming
-  05.1252.40ANI
05.1252.14ANI
Casambi
-  05.1252.40ACB
05.1252.14ACB



Optic Medium 3000K

-  Non Dimmable
03.9250.40A
03.9250.14A
Dali Version
-  03.9250.40ADA
03.9250.14ADA
Mains Dimming
-  03.9250.40ANI
03.9250.14ANI
Casambi
-  03.9250.40ACB
03.9250.14ACB
Non Dimmable
-  03.9251.40A
03.9251.14A
Dali Version
-  03.9251.40ADA
03.9251.14ADA
Mains Dimming
-  03.9251.40ANI
03.9251.14ANI
Casambi
-  03.9251.40ACB
03.9251.14ACB
Non Dimmable
-  05.1255.40A
05.1255.14A
Dali Version
-  05.1255.40ADA
05.1255.14ADA
Mains Dimming
-  05.1255.40ANI
05.1255.14ANI
Casambi
-  05.1255.40ACB
05.1255.14ACB
Non Dimmable
-  05.1256.40A
05.1256.14A
Dali Version
-  05.1256.40ADA
05.1256.14ADA
Mains Dimming
-  05.1256.40ANI
05.1256.14ANI
Casambi
-  05.1256.40ACB
05.1256.14ACB
Non Dimmable
-  05.1257.40A
05.1257.14A
Dali Version
-  05.1257.40ADA
05.1257.14ADA
Mains Dimming
-  05.1257.40ANI
05.1257.14ANI
Casambi
-  05.1257.40ACB
05.1257.14ACB

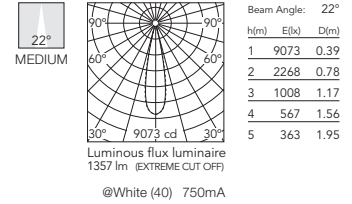
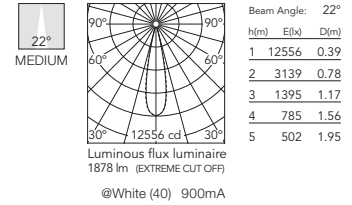

LIGHT SHADOW

Light Shadow Fixed No Trim 8 Spots

Light Source: Power LED DC 900 mA 21,6W - 2160 lm - 2700K/CRI 90 / 21,6W - 2280 lm - 3000K/CRI 90
 Mains dimming: Power LED DC 750 mA 18,5W - 1800 lm - 2700K/CRI 90 / 18,5W - 1900 lm - 3000K/CRI 90

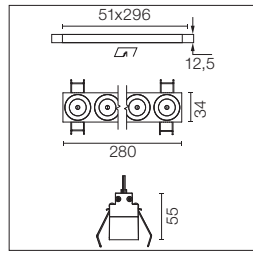

GWT 850° IP 55
 0,50 Kg
 h=75 min
 CE
 LED INCL

Leuchte für Unterputzmontage mit 8 LED-Lichtquellen. Externes Netzgerät eingeschlossen (220-240V). Vorinstallationsrahmen. Muss separat bestellt werden.

E= Außenfarbe
 I= Innenfarbe

Recessed integrated luminaire with 8 LED lighting spots. Remote power supply included (220-240V). It requires a pre-installation frame, to be ordered separately.

E= External Finish
 I= Internal Finish

Optic Flood 2700K

- | | |
|-----|---------------|
| E I | Non Dimmable |
| ■ ■ | 03.9245.40A |
| ■ ■ | 03.9245.14A |
| | Dali Version |
| ■ ■ | 03.9245.40ADA |
| ■ ■ | 03.9245.14ADA |
| | Mains Dimming |
| ■ ■ | 03.9245.40ANI |
| ■ ■ | 03.9245.14ANI |
| | Casambi |
| ■ ■ | 03.9245.40ACB |
| ■ ■ | 03.9245.14ACB |
| | Non Dimmable |
| ■ ■ | 03.9246.40A |
| ■ ■ | 03.9246.14A |
| | Dali Version |
| ■ ■ | 03.9246.40ADA |
| ■ ■ | 03.9246.14ADA |
| | Mains Dimming |
| ■ ■ | 03.9246.40ANI |
| ■ ■ | 03.9246.14ANI |
| | Casambi |
| ■ ■ | 03.9246.40ACB |
| ■ ■ | 03.9246.14ACB |
| | Non Dimmable |
| ■ ■ | 05.1260.40A |
| ■ ■ | 05.1260.14A |
| | Dali Version |
| ■ ■ | 05.1260.40ADA |
| ■ ■ | 05.1260.14ADA |
| | Mains Dimming |
| ■ ■ | 05.1260.40ANI |
| ■ ■ | 05.1260.14ANI |
| | Casambi |
| ■ ■ | 05.1260.40ACB |
| ■ ■ | 05.1260.14ACB |
| | Non Dimmable |
| ■ ■ | 05.1261.40A |
| ■ ■ | 05.1261.14A |
| | Dali Version |
| ■ ■ | 05.1261.40ADA |
| ■ ■ | 05.1261.14ADA |
| | Mains Dimming |
| ■ ■ | 05.1261.40ANI |
| ■ ■ | 05.1261.14ANI |
| | Casambi |
| ■ ■ | 05.1261.40ACB |
| ■ ■ | 05.1261.14ACB |
| | Non Dimmable |
| ■ ■ | 05.1262.40A |
| ■ ■ | 05.1262.14A |
| | Dali Version |
| ■ ■ | 05.1262.40ADA |
| ■ ■ | 05.1262.14ADA |
| | Mains Dimming |
| ■ ■ | 05.1262.40ANI |
| ■ ■ | 05.1262.14ANI |
| | Casambi |
| ■ ■ | 05.1262.40ACB |
| ■ ■ | 05.1262.14ACB |

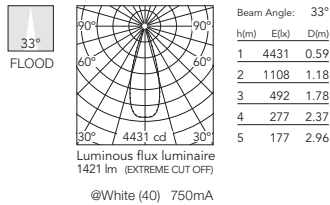
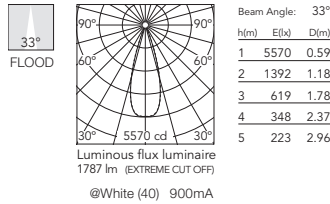





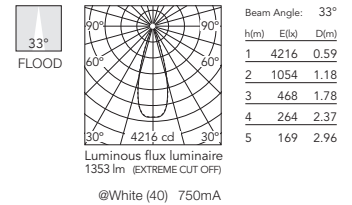
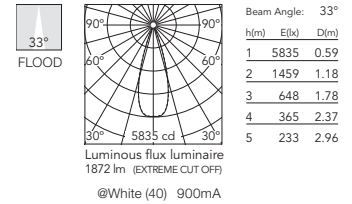















Optic Flood 3000K

- | | |
|-----|---------------|
| E I | Non Dimmable |
| ■ ■ | 03.9255.40A |
| ■ ■ | 03.9255.14A |
| | Dali Version |
| ■ ■ | 03.9255.40ADA |
| ■ ■ | 03.9255.14ADA |
| | Mains Dimming |
| ■ ■ | 03.9255.40ANI |
| ■ ■ | 03.9255.14ANI |
| | Casambi |
| ■ ■ | 03.9255.40ACB |
| ■ ■ | 03.9255.14ACB |
| | Non Dimmable |
| ■ ■ | 03.9256.40A |
| ■ ■ | 03.9256.14A |
| | Dali Version |
| ■ ■ | 03.9256.40ADA |
| ■ ■ | 03.9256.14ADA |
| | Mains Dimming |
| ■ ■ | 03.9256.40ANI |
| ■ ■ | 03.9256.14ANI |
| | Casambi |
| ■ ■ | 03.9256.40ACB |
| ■ ■ | 03.9256.14ACB |
| | Non Dimmable |
| ■ ■ | 05.1265.40A |
| ■ ■ | 05.1265.14A |
| | Dali Version |
| ■ ■ | 05.1265.40ADA |
| ■ ■ | 05.1265.14ADA |
| | Mains Dimming |
| ■ ■ | 05.1265.40ANI |
| ■ ■ | 05.1265.14ANI |
| | Casambi |
| ■ ■ | 05.1265.40ACB |
| ■ ■ | 05.1265.14ACB |
| | Non Dimmable |
| ■ ■ | 05.1266.40A |
| ■ ■ | 05.1266.14A |
| | Dali Version |
| ■ ■ | 05.1266.40ADA |
| ■ ■ | 05.1266.14ADA |
| | Mains Dimming |
| ■ ■ | 05.1266.40ANI |
| ■ ■ | 05.1266.14ANI |
| | Casambi |
| ■ ■ | 05.1266.40ACB |
| ■ ■ | 05.1266.14ACB |
| | Non Dimmable |
| ■ ■ | 05.1267.40A |
| ■ ■ | 05.1267.14A |
| | Dali Version |
| ■ ■ | 05.1267.40ADA |
| ■ ■ | 05.1267.14ADA |
| | Mains Dimming |
| ■ ■ | 05.1267.40ANI |
| ■ ■ | 05.1267.14ANI |
| | Casambi |
| ■ ■ | 05.1267.40ACB |
| ■ ■ | 05.1267.14ACB |







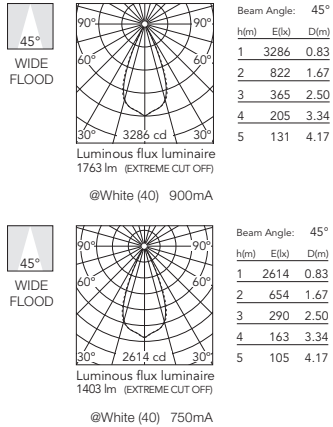















Optic Wide Flood 2700K

-  Non Dimmable
03.8366.40A
03.8366.14A
Dali Version
-  03.8366.40ADA
03.8366.14ADA
Mains Dimming
-  03.8366.40ANI
03.8366.14ANI
Casambi
-  03.8366.40ACB
03.8366.14ACB
Non Dimmable
-  03.8367.40A
03.8367.14A
Dali Version
-  03.8367.40ADA
03.8367.14ADA
Mains Dimming
-  03.8367.40ANI
03.8367.14ANI
Casambi
-  03.8367.40ACB
03.8367.14ACB
Non Dimmable
-  05.1270.40A
05.1270.14A
Dali Version
-  05.1270.40ADA
05.1270.14ADA
Mains Dimming
-  05.1270.40ANI
05.1270.14ANI
Casambi
-  05.1270.40ACB
05.1270.14ACB
Non Dimmable
-  05.1271.40A
05.1271.14A
Dali Version
-  05.1271.40ADA
05.1271.14ADA
Mains Dimming
-  05.1271.40ANI
05.1271.14ANI
Casambi
-  05.1271.40ACB
05.1271.14ACB
Non Dimmable
-  05.1272.40A
05.1272.14A
Dali Version
-  05.1272.40ADA
05.1272.14ADA
Mains Dimming
-  05.1272.40ANI
05.1272.14ANI
Casambi
-  05.1272.40ACB
05.1272.14ACB



Optic Wide Flood 3000K

-  Non Dimmable
03.8370.40A
03.8370.14A
Dali Version
-  03.8370.40ADA
03.8370.14ADA
Mains Dimming
-  03.8370.40ANI
03.8370.14ANI
Casambi
-  03.8370.40ACB
03.8370.14ACB
Non Dimmable
-  03.8371.40A
03.8371.14A
Dali Version
-  03.8371.40ADA
03.8371.14ADA
Mains Dimming
-  03.8371.40ANI
03.8371.14ANI
Casambi
-  03.8371.40ACB
03.8371.14ACB
Non Dimmable
-  05.1275.40A
05.1275.14A
Dali Version
-  05.1275.40ADA
05.1275.14ADA
Mains Dimming
-  05.1275.40ANI
05.1275.14ANI
Casambi
-  05.1275.40ACB
05.1275.14ACB
Non Dimmable
-  05.1276.40A
05.1276.14A
Dali Version
-  05.1276.40ADA
05.1276.14ADA
Mains Dimming
-  05.1276.40ANI
05.1276.14ANI
Casambi
-  05.1276.40ACB
05.1276.14ACB
Non Dimmable
-  05.1277.40A
05.1277.14A
Dali Version
-  05.1277.40ADA
05.1277.14ADA
Mains Dimming
-  05.1277.40ANI
05.1277.14ANI
Casambi
-  05.1277.40ACB
05.1277.14ACB

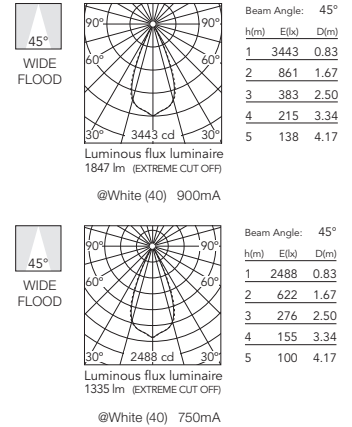

LIGHT SHADOW

Light Shadow Fixed No Trim 12 Spots

Light Source: Power LED DC 900 mA 32,4W - 3240 lm - 2700K/CRI 90 / 32,4W - 3420 lm - 3000K/CRI 90
 Mains dimming: Power LED DC 750 mA 28W - 2710 lm - 2700K/CRI 90 / 28W - 2860 lm - 3000K/CRI 90

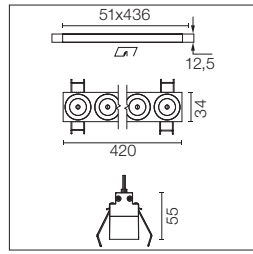

GWT 850°
 IP 55
 0.66 Kg
 Eco
 TEGEE
 h=75 min
 CE
 DALI
 LED INCL

Leuchte für Unterputzmontage mit 12 LED-Lichtquellen. Externes Netzgerät eingeschlossen (220-240V). Vorinstallationsrahmen. Muss separat bestellt werden.

Recessed integrated luminaire with 12 LED lighting spots. Remote power supply included (220-240V). It requires a pre-installation frame, to be ordered separately.

E= Außenfarbe
I= Innenfarbe

E= External Finish
I= Internal Finish

Optic Spot 2700K

- | | |
|--|---------------------|
| | Non Dimmable |
| | 03.8876.40A |
| | 03.8876.14A |
| | Dali & Push Version |
| | 03.8876.40ADA |
| | 03.8876.14ADA |
| | Mains Dimming |
| | 03.8876.40ANI |
| | 03.8876.14ANI |
| | Casambi |
| | 03.8876.40ACB |
| | 03.8876.14ACB |
| | Non Dimmable |
| | 03.8877.40A |
| | 03.8877.14A |
| | Dali & Push Version |
| | 03.8877.40ADA |
| | 03.8877.14ADA |
| | Mains Dimming |
| | 03.8877.40ANI |
| | 03.8877.14ANI |
| | Casambi |
| | 03.8877.40ACB |
| | 03.8877.14ACB |
| | Non Dimmable |
| | 05.1340.40A |
| | 05.1340.14A |
| | Dali & Push Version |
| | 05.1340.40ADA |
| | 05.1340.14ADA |
| | Mains Dimming |
| | 05.1340.40ANI |
| | 05.1340.14ANI |
| | Casambi |
| | 05.1340.40ACB |
| | 05.1340.14ACB |
| | Non Dimmable |
| | 05.1341.40A |
| | 05.1341.14A |
| | Dali & Push Version |
| | 05.1341.40ADA |
| | 05.1341.14ADA |
| | Mains Dimming |
| | 05.1341.40ANI |
| | 05.1341.14ANI |
| | Casambi |
| | 05.1341.40ACB |
| | 05.1341.14ACB |
| | Non Dimmable |
| | 05.1342.40A |
| | 05.1342.14A |
| | Dali & Push Version |
| | 05.1342.40ADA |
| | 05.1342.14ADA |
| | Mains Dimming |
| | 05.1342.40ANI |
| | 05.1342.14ANI |
| | Casambi |
| | 05.1342.40ACB |
| | 05.1342.14ACB |

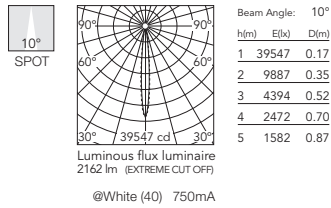
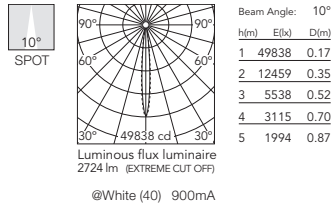





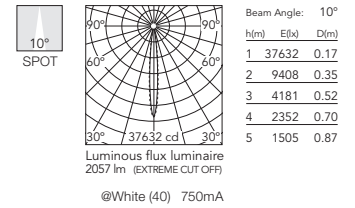
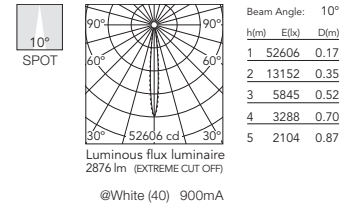















Optic Spot 3000K

- | | |
|--|---------------------|
| | Non Dimmable |
| | 03.8880.40A |
| | 03.8880.14A |
| | Dali & Push Version |
| | 03.8880.40ADA |
| | 03.8880.14ADA |
| | Mains Dimming |
| | 03.8880.40ANI |
| | 03.8880.14ANI |
| | Casambi |
| | 03.8880.40ACB |
| | 03.8880.14ACB |
| | Non Dimmable |
| | 03.8881.40A |
| | 03.8881.14A |
| | Dali & Push Version |
| | 03.8881.40ADA |
| | 03.8881.14ADA |
| | Mains Dimming |
| | 03.8881.40ANI |
| | 03.8881.14ANI |
| | Casambi |
| | 03.8881.40ACB |
| | 03.8881.14ACB |
| | Non Dimmable |
| | 05.1345.40A |
| | 05.1345.14A |
| | Dali & Push Version |
| | 05.1345.40ADA |
| | 05.1345.14ADA |
| | Mains Dimming |
| | 05.1345.40ANI |
| | 05.1345.14ANI |
| | Casambi |
| | 05.1345.40ACB |
| | 05.1345.14ACB |
| | Non Dimmable |
| | 05.1346.40A |
| | 05.1346.14A |
| | Dali & Push Version |
| | 05.1346.40ADA |
| | 05.1346.14ADA |
| | Mains Dimming |
| | 05.1346.40ANI |
| | 05.1346.14ANI |
| | Casambi |
| | 05.1346.40ACB |
| | 05.1346.14ACB |
| | Non Dimmable |
| | 05.1347.40A |
| | 05.1347.14A |
| | Dali & Push Version |
| | 05.1347.40ADA |
| | 05.1347.14ADA |
| | Mains Dimming |
| | 05.1347.40ANI |
| | 05.1347.14ANI |
| | Casambi |
| | 05.1347.40ACB |
| | 05.1347.14ACB |







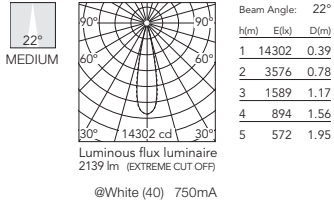
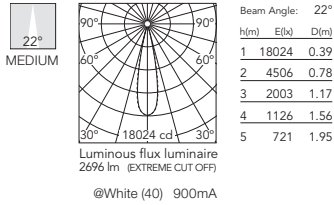















Optic Medium 2700K

-  Non Dimmable
03.9260.40A
03.9260.14A
Dali & Push Version
-  03.9260.40ADA
03.9260.14ADA
Mains Dimming
-  03.9260.40ANI
03.9260.14ANI
Casambi
-  03.9260.40ACB
03.9260.14ACB
Non Dimmable
-  03.9261.40A
03.9261.14A
Dali & Push Version
-  03.9261.40ADA
03.9261.14ADA
Mains Dimming
-  03.9261.40ANI
03.9261.14ANI
Casambi
-  03.9261.40ACB
03.9261.14ACB
Non Dimmable
-  05.1350.40A
05.1350.14A
Dali & Push Version
-  05.1350.40ADA
05.1350.14ADA
Mains Dimming
-  05.1350.40ANI
05.1350.14ANI
Casambi
-  05.1350.40ACB
05.1350.14ACB
Non Dimmable
-  05.1351.40A
05.1351.14A
Dali & Push Version
-  05.1351.40ADA
05.1351.14ADA
Mains Dimming
-  05.1351.40ANI
05.1351.14ANI
Casambi
-  05.1351.40ACB
05.1351.14ACB
Non Dimmable
-  05.1352.40A
05.1352.14A
Dali & Push Version
-  05.1352.40ADA
05.1352.14ADA
Mains Dimming
-  05.1352.40ANI
05.1352.14ANI
Casambi
-  05.1352.40ACB
05.1352.14ACB



Optic Medium 3000K

-  Non Dimmable
03.9270.40A
03.9270.14A
Dali & Push Version
-  03.9270.40ADA
03.9270.14ADA
Mains Dimming
-  03.9270.40ANI
03.9270.14ANI
Casambi
-  03.9270.40ACB
03.9270.14ACB
Non Dimmable
-  03.9271.40A
03.9271.14A
Dali & Push Version
-  03.9271.40ADA
03.9271.14ADA
Mains Dimming
-  03.9271.40ANI
03.9271.14ANI
Casambi
-  03.9271.40ACB
03.9271.14ACB
Non Dimmable
-  05.1355.40A
05.1355.14A
Dali & Push Version
-  05.1355.40ADA
05.1355.14ADA
Mains Dimming
-  05.1355.40ANI
05.1355.14ANI
Casambi
-  05.1355.40ACB
05.1355.14ACB
Non Dimmable
-  05.1356.40A
05.1356.14A
Dali & Push Version
-  05.1356.40ADA
05.1356.14ADA
Mains Dimming
-  05.1356.40ANI
05.1356.14ANI
Casambi
-  05.1356.40ACB
05.1356.14ACB
Non Dimmable
-  05.1357.40A
05.1357.14A
Dali & Push Version
-  05.1357.40ADA
05.1357.14ADA
Mains Dimming
-  05.1357.40ANI
05.1357.14ANI
Casambi
-  05.1357.40ACB
05.1357.14ACB

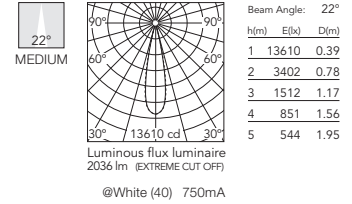
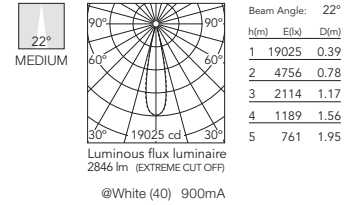

Light Shadow Fixed No Trim 12 Spots

Light Source: Power LED DC 900 mA 32,4W - 3240 lm - 2700K/CRI 90 / 32,4W - 3420 lm - 3000K/CRI 90
 Mains dimming: Power LED DC 750 mA 28W - 2710 lm - 2700K/CRI 90 / 28W - 2860 lm - 3000K/CRI 90

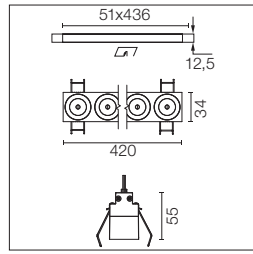

GWT 850°
 IP 55
 0.66 Kg
 Eco
 TEGEE
 h=75 min
 CE
 DALI
 LED INCL

Leuchte für Unterputzmontage mit 12 LED-Lichtquellen. Externes Netzgerät eingeschlossen (220-240V). Vorinstallationsrahmen. Muss separat bestellt werden.

Recessed integrated luminaire with 12 LED lighting spots. Remote power supply included (220-240V). It requires a pre-installation frame, to be ordered separately.

E= Außenfarbe
I= Innenfarbe

E= External Finish
I= Internal Finish

Optic Flood 2700K

- | | |
|--|---------------------|
| | Non Dimmable |
| | 03.9265.40A |
| | 03.9265.14A |
| | Dali & Push Version |
| | 03.9265.40ADA |
| | 03.9265.14ADA |
| | Mains Dimming |
| | 03.9265.40ANI |
| | 03.9265.14ANI |
| | Casambi |
| | 03.9265.40ACB |
| | 03.9265.14ACB |
| | Non Dimmable |
| | 03.9266.40A |
| | 03.9266.14A |
| | Dali & Push Version |
| | 03.9266.40ADA |
| | 03.9266.14ADA |
| | Mains Dimming |
| | 03.9266.40ANI |
| | 03.9266.14ANI |
| | Casambi |
| | 03.9266.40ACB |
| | 03.9266.14ACB |
| | Non Dimmable |
| | 05.1360.40A |
| | 05.1360.14A |
| | Dali & Push Version |
| | 05.1360.40ADA |
| | 05.1360.14ADA |
| | Mains Dimming |
| | 05.1360.40ANI |
| | 05.1360.14ANI |
| | Casambi |
| | 05.1360.40ACB |
| | 05.1360.14ACB |
| | Non Dimmable |
| | 05.1361.40A |
| | 05.1361.14A |
| | Dali & Push Version |
| | 05.1361.40ADA |
| | 05.1361.14ADA |
| | Mains Dimming |
| | 05.1361.40ANI |
| | 05.1361.14ANI |
| | Casambi |
| | 05.1361.40ACB |
| | 05.1361.14ACB |
| | Non Dimmable |
| | 05.1362.40A |
| | 05.1362.14A |
| | Dali & Push Version |
| | 05.1362.40ADA |
| | 05.1362.14ADA |
| | Mains Dimming |
| | 05.1362.40ANI |
| | 05.1362.14ANI |
| | Casambi |
| | 05.1362.40ACB |
| | 05.1362.14ACB |

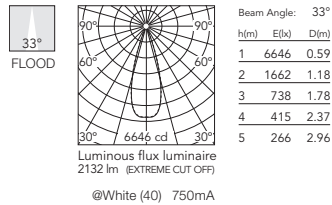
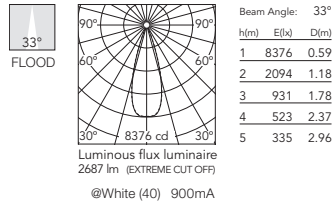

Optic Flood 3000K

- | | |
|--|---------------------|
| | Non Dimmable |
| | 03.9275.40A |
| | 03.9275.14A |
| | Dali & Push Version |
| | 03.9275.40ADA |
| | 03.9275.14ADA |
| | Mains Dimming |
| | 03.9275.40ANI |
| | 03.9275.14ANI |
| | Casambi |
| | 03.9275.40ACB |
| | 03.9275.14ACB |
| | Non Dimmable |
| | 03.9276.40A |
| | 03.9276.14A |
| | Dali & Push Version |
| | 03.9276.40ADA |
| | 03.9276.14ADA |
| | Mains Dimming |
| | 03.9276.40ANI |
| | 03.9276.14ANI |
| | Casambi |
| | 03.9276.40ACB |
| | 03.9276.14ACB |
| | Non Dimmable |
| | 05.1365.40A |
| | 05.1365.14A |
| | Dali & Push Version |
| | 05.1365.40ADA |
| | 05.1365.14ADA |
| | Mains Dimming |
| | 05.1365.40ANI |
| | 05.1365.14ANI |
| | Casambi |
| | 05.1365.40ACB |
| | 05.1365.14ACB |
| | Non Dimmable |
| | 05.1366.40A |
| | 05.1366.14A |
| | Dali & Push Version |
| | 05.1366.40ADA |
| | 05.1366.14ADA |
| | Mains Dimming |
| | 05.1366.40ANI |
| | 05.1366.14ANI |
| | Casambi |
| | 05.1366.40ACB |
| | 05.1366.14ACB |
| | Non Dimmable |
| | 05.1367.40A |
| | 05.1367.14A |
| | Dali & Push Version |
| | 05.1367.40ADA |
| | 05.1367.14ADA |
| | Mains Dimming |
| | 05.1367.40ANI |
| | 05.1367.14ANI |
| | Casambi |
| | 05.1367.40ACB |
| | 05.1367.14ACB |

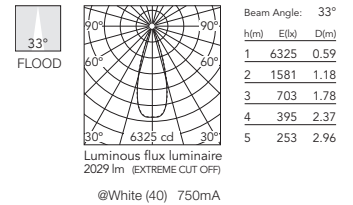
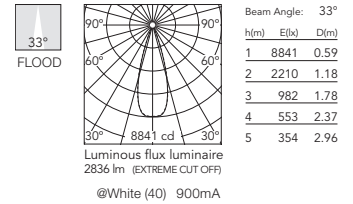

LIGHT SHADOW

Optic Wide Flood 2700K

- E I Non Dimmable
03.8374.40A
03.8374.14A
Dali & Push Version
- E I Non Dimmable
03.8374.40ADA
03.8374.14ADA
Mains Dimming
- E I Non Dimmable
03.8374.40ANI
03.8374.14ANI
Casambi
- E I Non Dimmable
03.8374.40ACB
03.8374.14ACB
Non Dimmable
- E I Non Dimmable
03.8375.40A
03.8375.14A
Dali & Push Version
- E I Non Dimmable
03.8375.40ADA
03.8375.14ADA
Mains Dimming
- E I Non Dimmable
03.8375.40ANI
03.8375.14ANI
Casambi
- E I Non Dimmable
03.8375.40ACB
03.8375.14ACB
Non Dimmable
- E I Non Dimmable
05.1370.40A
05.1370.14A
Dali & Push Version
- E I Non Dimmable
05.1370.40ADA
05.1370.14ADA
Mains Dimming
- E I Non Dimmable
05.1370.40ANI
05.1370.14ANI
Casambi
- E I Non Dimmable
05.1370.40ACB
05.1370.14ACB
Non Dimmable
- E I Non Dimmable
05.1371.40A
05.1371.14A
Dali & Push Version
- E I Non Dimmable
05.1371.40ADA
05.1371.14ADA
Mains Dimming
- E I Non Dimmable
05.1371.40ANI
05.1371.14ANI
Casambi
- E I Non Dimmable
05.1371.40ACB
05.1371.14ACB
Non Dimmable
- E I Non Dimmable
05.1372.40A
05.1372.14A
Dali & Push Version
- E I Non Dimmable
05.1372.40ADA
05.1372.14ADA
Mains Dimming
- E I Non Dimmable
05.1372.40ANI
05.1372.14ANI
Casambi
- E I Non Dimmable
05.1372.40ACB
05.1372.14ACB
Non Dimmable

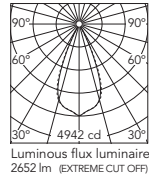

Beam Angle: 45°

h(m)	E(ft)	D(m)
1	4942	0.83
2	1235	1.67
3	549	2.50
4	309	3.34
5	198	4.17

Luminous flux luminaire 4942 cd
2652 lm (EXTREME CUT OFF)

@White (40) 900mA

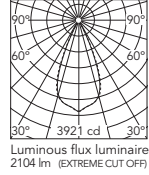

Beam Angle: 45°

h(m)	E(ft)	D(m)
1	3921	0.83
2	980	1.67
3	436	2.50
4	245	3.34
5	157	4.17

Luminous flux luminaire 3921 cd
2104 lm (EXTREME CUT OFF)

@White (40) 750mA

Optic Wide Flood 3000K

- E I Non Dimmable
03.8378.40A
03.8378.14A
Dali & Push Version
- E I Non Dimmable
03.8378.40ADA
03.8378.14ADA
Mains Dimming
- E I Non Dimmable
03.8378.40ANI
03.8378.14ANI
Casambi
- E I Non Dimmable
03.8378.40ACB
03.8378.14ACB
Non Dimmable
- E I Non Dimmable
03.8379.40A
03.8379.14A
Dali & Push Version
- E I Non Dimmable
03.8379.40ADA
03.8379.14ADA
Mains Dimming
- E I Non Dimmable
03.8379.40ANI
03.8379.14ANI
Casambi
- E I Non Dimmable
03.8379.40ACB
03.8379.14ACB
Non Dimmable
- E I Non Dimmable
05.1375.40A
05.1375.14A
Dali & Push Version
- E I Non Dimmable
05.1375.40ADA
05.1375.14ADA
Mains Dimming
- E I Non Dimmable
05.1375.40ANI
05.1375.14ANI
Casambi
- E I Non Dimmable
05.1375.40ACB
05.1375.14ACB
Non Dimmable
- E I Non Dimmable
05.1376.40A
05.1376.14A
Dali & Push Version
- E I Non Dimmable
05.1376.40ADA
05.1376.14ADA
Mains Dimming
- E I Non Dimmable
05.1376.40ANI
05.1376.14ANI
Casambi
- E I Non Dimmable
05.1376.40ACB
05.1376.14ACB
Non Dimmable
- E I Non Dimmable
05.1377.40A
05.1377.14A
Dali & Push Version
- E I Non Dimmable
05.1377.40ADA
05.1377.14ADA
Mains Dimming
- E I Non Dimmable
05.1377.40ANI
05.1377.14ANI
Casambi
- E I Non Dimmable
05.1377.40ACB
05.1377.14ACB
Non Dimmable

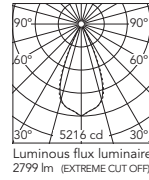

Beam Angle: 45°

h(m)	E(ft)	D(m)
1	5216	0.83
2	1304	1.67
3	580	2.50
4	326	3.34
5	209	4.17

Luminous flux luminaire 5216 cd
2799 lm (EXTREME CUT OFF)

@White (40) 900mA

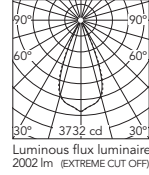

Beam Angle: 45°

h(m)	E(ft)	D(m)
1	3732	0.83
2	933	1.67
3	415	2.50
4	233	3.34
5	149	4.17

Luminous flux luminaire 3732 cd
2002 lm (EXTREME CUT OFF)

@White (40) 750mA

LIGHT SHADOW

Light Shadow Adjustable Trim 2 Spots

Light Source: Power LED DC 900 mA 5,4W - 540 lm - 2700K/CRI 90 / 5,4W - 570 lm - 3000K/CRI 90

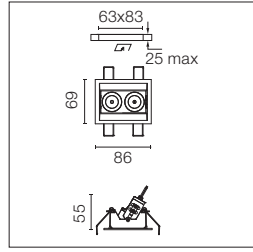

- GWT 850°
- 30°-30°
- 0,25 Kg
- TECEE**
- DALI
- LED INCL
- h=150 min
- CE
- IP 20

Leuchte für Unterputzmontage mit 2 LED-Lichtquellen. Externes Netzgerät eingeschlossen (220-240V). Vorinstallationsrahmen nicht erforderlich.

Recessed integrated luminaire with 2 LED lighting spots. Remote power supply included (220-240V). Pre-Installation frame not required.

E= Außenfarbe
I= Innenfarbe

E= External Finish
I= Internal Finish

Optic Spot 2700K

- | E | I | Non Dimmable |
|---|---|---------------|
| □ | □ | 03.8884.40A |
| □ | □ | 03.8884.14A |
| □ | □ | Dali Version |
| □ | □ | 03.8884.40ADA |
| □ | □ | 03.8884.14ADA |
| □ | □ | Mains Dimming |
| □ | □ | 03.8884.40ANI |
| □ | □ | 03.8884.14ANI |
| □ | □ | Casambi |
| □ | □ | 03.8884.40ACB |
| □ | □ | 03.8884.14ACB |
| □ | □ | Non Dimmable |
| □ | □ | 03.8885.40A |
| □ | □ | 03.8885.14A |
| □ | □ | Dali Version |
| □ | □ | 03.8885.40ADA |
| □ | □ | 03.8885.14ADA |
| □ | □ | Mains Dimming |
| □ | □ | 03.8885.40ANI |
| □ | □ | 03.8885.14ANI |
| □ | □ | Casambi |
| □ | □ | 03.8885.40ACB |
| □ | □ | 03.8885.14ACB |
| □ | □ | Non Dimmable |
| □ | □ | 05.1400.40A |
| □ | □ | 05.1400.14A |
| □ | □ | Dali Version |
| □ | □ | 05.1400.40ADA |
| □ | □ | 05.1400.14ADA |
| □ | □ | Mains Dimming |
| □ | □ | 05.1400.40ANI |
| □ | □ | 05.1400.14ANI |
| □ | □ | Casambi |
| □ | □ | 05.1400.40ACB |
| □ | □ | 05.1400.14ACB |
| □ | □ | Non Dimmable |
| □ | □ | 05.1401.40A |
| □ | □ | 05.1401.14A |
| □ | □ | Dali Version |
| □ | □ | 05.1401.40ADA |
| □ | □ | 05.1401.14ADA |
| □ | □ | Mains Dimming |
| □ | □ | 05.1401.40ANI |
| □ | □ | 05.1401.14ANI |
| □ | □ | Casambi |
| □ | □ | 05.1401.40ACB |
| □ | □ | 05.1401.14ACB |
| □ | □ | Non Dimmable |
| □ | □ | 05.1402.40A |
| □ | □ | 05.1402.14A |
| □ | □ | Dali Version |
| □ | □ | 05.1402.40ADA |
| □ | □ | 05.1402.14ADA |
| □ | □ | Mains Dimming |
| □ | □ | 05.1402.40ANI |
| □ | □ | 05.1402.14ANI |
| □ | □ | Casambi |
| □ | □ | 05.1402.40ACB |
| □ | □ | 05.1402.14ACB |

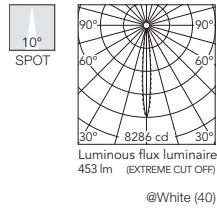





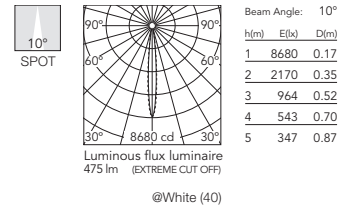















Optic Spot 3000K

- | E | I | Non Dimmable |
|---|---|---------------|
| □ | □ | 03.8888.40A |
| □ | □ | 03.8888.14A |
| □ | □ | Dali Version |
| □ | □ | 03.8888.40ADA |
| □ | □ | 03.8888.14ADA |
| □ | □ | Mains Dimming |
| □ | □ | 03.8888.40ANI |
| □ | □ | 03.8888.14ANI |
| □ | □ | Casambi |
| □ | □ | 03.8888.40ACB |
| □ | □ | 03.8888.14ACB |
| □ | □ | Non Dimmable |
| □ | □ | 03.8889.40A |
| □ | □ | 03.8889.14A |
| □ | □ | Dali Version |
| □ | □ | 03.8889.40ADA |
| □ | □ | 03.8889.14ADA |
| □ | □ | Mains Dimming |
| □ | □ | 03.8889.40ANI |
| □ | □ | 03.8889.14ANI |
| □ | □ | Casambi |
| □ | □ | 03.8889.40ACB |
| □ | □ | 03.8889.14ACB |
| □ | □ | Non Dimmable |
| □ | □ | 05.1405.40A |
| □ | □ | 05.1405.14A |
| □ | □ | Dali Version |
| □ | □ | 05.1405.40ADA |
| □ | □ | 05.1405.14ADA |
| □ | □ | Mains Dimming |
| □ | □ | 05.1405.40ANI |
| □ | □ | 05.1405.14ANI |
| □ | □ | Casambi |
| □ | □ | 05.1405.40ACB |
| □ | □ | 05.1405.14ACB |
| □ | □ | Non Dimmable |
| □ | □ | 05.1406.40A |
| □ | □ | 05.1406.14A |
| □ | □ | Dali Version |
| □ | □ | 05.1406.40ADA |
| □ | □ | 05.1406.14ADA |
| □ | □ | Mains Dimming |
| □ | □ | 05.1406.40ANI |
| □ | □ | 05.1406.14ANI |
| □ | □ | Casambi |
| □ | □ | 05.1406.40ACB |
| □ | □ | 05.1406.14ACB |
| □ | □ | Non Dimmable |
| □ | □ | 05.1407.40A |
| □ | □ | 05.1407.14A |
| □ | □ | Dali Version |
| □ | □ | 05.1407.40ADA |
| □ | □ | 05.1407.14ADA |
| □ | □ | Mains Dimming |
| □ | □ | 05.1407.40ANI |
| □ | □ | 05.1407.14ANI |
| □ | □ | Casambi |
| □ | □ | 05.1407.40ACB |
| □ | □ | 05.1407.14ACB |



**Optic Medium
2700K**



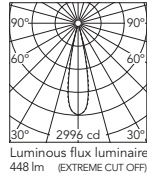

















-  Non Dimmable
03.9300.40A
03.9300.14A
Dali Version
-  03.9300.40ADA
03.9300.14ADA
Mains Dimming
-  03.9300.40ANI
03.9300.14ANI
Casambi
-  03.9300.40CB
03.9300.14ACB
Non Dimmable
-  03.9301.40A
03.9301.14A
Dali Version
-  03.9301.40ADA
03.9301.14ADA
Mains Dimming
-  03.9301.40ANI
03.9301.14ANI
Casambi
-  03.9301.40ACB
03.9301.14ACB
Non Dimmable
-  05.1410.40A
05.1410.14A
Dali Version
-  05.1410.40ADA
05.1410.14ADA
Mains Dimming
-  05.1410.40ANI
05.1410.14ANI
Casambi
-  05.1410.40ACB
05.1410.14ACB
Non Dimmable
-  05.1411.40A
05.1411.14A
Dali Version
-  05.1411.40ADA
05.1411.14ADA
Mains Dimming
-  05.1411.40ANI
05.1411.14ANI
Casambi
-  05.1411.40ACB
05.1411.14ACB
Non Dimmable
-  05.1412.40A
05.1412.14A
Dali Version
-  05.1412.40ADA
05.1412.14ADA
Mains Dimming
-  05.1412.40ANI
05.1412.14ANI
Casambi
-  05.1412.40ACB
05.1412.14ACB



Beam Angle: 22°

h(m)	E(lx)	D(m)
1	2996	0.39
2	749	0.78
3	333	1.17
4	187	1.56
5	120	1.95

**Optic Medium
3000K**

-  Non Dimmable
03.9310.40A
03.9310.14A
Dali Version
-  03.9310.40ADA
03.9310.14ADA
Mains Dimming
-  03.9310.40ANI
03.9310.14ANI
Casambi
-  03.9310.40ACB
03.9310.14ACB
Non Dimmable
-  03.9311.40A
03.9311.14A
Dali Version
-  03.9311.40ADA
03.9311.14ADA
Mains Dimming
-  03.9311.40ANI
03.9311.14ANI
Casambi
-  03.9311.40ACB
03.9311.14ACB
Non Dimmable
-  05.1415.40A
05.1415.14A
Dali Version
-  05.1415.40ADA
05.1415.14ADA
Mains Dimming
-  05.1415.40ANI
05.1415.14ANI
Casambi
-  05.1415.40ACB
05.1415.14ACB
Non Dimmable
-  05.1416.40A
05.1416.14A
Dali Version
-  05.1416.40ADA
05.1416.14ADA
Mains Dimming
-  05.1416.40ANI
05.1416.14ANI
Casambi
-  05.1416.40ACB
05.1416.14ACB
Non Dimmable
-  05.1417.40A
05.1417.14A
Dali Version
-  05.1417.40ADA
05.1417.14ADA
Mains Dimming
-  05.1417.40ANI
05.1417.14ANI
Casambi
-  05.1417.40ACB
05.1417.14ACB

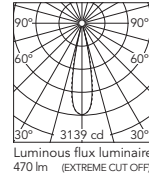

Beam Angle: 22°

h(m)	E(lx)	D(m)
1	3139	0.39
2	785	0.78
3	349	1.17
4	196	1.56
5	126	1.95

Light Shadow Adjustable Trim 2 Spots

Light Source: Power LED DC 900 mA 5,4W - 540 lm - 2700K/CRI 90 / 5,4W - 570 lm - 3000K/CRI 90

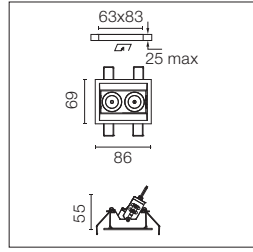

GWT 850°
 30°-30°
 0,25 Kg
 TECEE
 LED INCL
 DALI
 10-100%
 IP 20
 CE

Leuchte für Unterputzmontage mit 2 LED-Lichtquellen. Externes Netzgerät eingeschlossen (220-240V). Vorinstallationsrahmen nicht erforderlich.

E= Außenfarbe
I= Innenfarbe

Recessed integrated luminaire with 2 LED lighting spots. Remote power supply included (220-240V). Pre-Installation frame not required.

E= External Finish
I= Internal Finish

Optic Flood 2700K

- | | |
|--|---------------|
| | Non Dimmable |
| | 03.9305.40A |
| | 03.9305.14A |
| | Dali Version |
| | 03.9305.40ADA |
| | 03.9305.14ADA |
| | Mains Dimming |
| | 03.9305.40ANI |
| | 03.9305.14ANI |
| | Casambi |
| | 03.9305.40ACB |
| | 03.9305.14ACB |
| | Non Dimmable |
| | 03.9306.40A |
| | 03.9306.14A |
| | Dali Version |
| | 03.9306.40ADA |
| | 03.9306.14ADA |
| | Mains Dimming |
| | 03.9306.40ANI |
| | 03.9306.14ANI |
| | Casambi |
| | 03.9306.40ACB |
| | 03.9306.14ACB |
| | Non Dimmable |
| | 05.1420.40A |
| | 05.1420.14A |
| | Dali Version |
| | 05.1420.40ADA |
| | 05.1420.14ADA |
| | Mains Dimming |
| | 05.1420.40ANI |
| | 05.1420.14ANI |
| | Casambi |
| | 05.1420.40ACB |
| | 05.1420.14ACB |
| | Non Dimmable |
| | 05.1421.40A |
| | 05.1421.14A |
| | Dali Version |
| | 05.1421.40ADA |
| | 05.1421.14ADA |
| | Mains Dimming |
| | 05.1421.40ANI |
| | 05.1421.14ANI |
| | Casambi |
| | 05.1421.40ACB |
| | 05.1421.14ACB |
| | Non Dimmable |
| | 05.1422.40A |
| | 05.1422.14A |
| | Dali Version |
| | 05.1422.40ADA |
| | 05.1422.14ADA |
| | Mains Dimming |
| | 05.1422.40ANI |
| | 05.1422.14ANI |
| | Casambi |
| | 05.1422.40ACB |
| | 05.1422.14ACB |

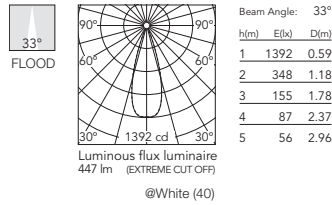





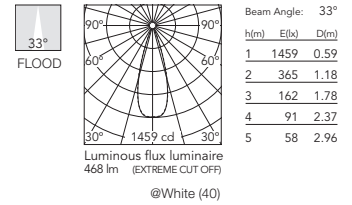



































Optic Flood 3000K

- | | |
|--|---------------|
| | Non Dimmable |
| | 03.9315.40A |
| | 03.9315.14A |
| | Dali Version |
| | 03.9315.40ADA |
| | 03.9315.14ADA |
| | Mains Dimming |
| | 03.9315.40ANI |
| | 03.9315.14ANI |
| | Casambi |
| | 03.9315.40ACB |
| | 03.9315.14ACB |
| | Non Dimmable |
| | 03.9316.40A |
| | 03.9316.14A |
| | Dali Version |
| | 03.9316.40ADA |
| | 03.9316.14ADA |
| | Mains Dimming |
| | 03.9316.40ANI |
| | 03.9316.14ANI |
| | Casambi |
| | 03.9316.40ACB |
| | 03.9316.14ACB |
| | Non Dimmable |
| | 05.1425.40A |
| | 05.1425.14A |
| | Dali Version |
| | 05.1425.40ADA |
| | 05.1425.14ADA |
| | Mains Dimming |
| | 05.1425.40ANI |
| | 05.1425.14ANI |
| | Casambi |
| | 05.1425.40ACB |
| | 05.1425.14ACB |
| | Non Dimmable |
| | 05.1426.40A |
| | 05.1426.14A |
| | Dali Version |
| | 05.1426.40ADA |
| | 05.1426.14ADA |
| | Mains Dimming |
| | 05.1426.40ANI |
| | 05.1426.14ANI |
| | Casambi |
| | 05.1426.40ACB |
| | 05.1426.14ACB |
| | Non Dimmable |
| | 05.1427.40A |
| | 05.1427.14A |
| | Dali Version |
| | 05.1427.40ADA |
| | 05.1427.14ADA |
| | Mains Dimming |
| | 05.1427.40ANI |
| | 05.1427.14ANI |
| | Casambi |
| | 05.1427.40ACB |
| | 05.1427.14ACB |



Optic Wide Flood 2700K

-  Non Dimmable
-  03.7300.40A
-  03.7300.14A
- Dali Version
-  03.7300.40ADA
-  03.7300.14ADA
- Mains Dimming
-  03.7300.40ANI
-  03.7300.14ANI
- Casambi
-  03.7300.40ACB
-  03.7300.14ACB
- Non Dimmable
-  03.7301.40A
-  03.7301.14A
- Dali Version
-  03.7301.40ADA
-  03.7301.14ADA
- Mains Dimming
-  03.7301.40ANI
-  03.7301.14ANI
- Casambi
-  03.7301.40ACB
-  03.7301.14ACB
- Non Dimmable
-  05.1430.40A
-  05.1430.14A
- Dali Version
-  05.1430.40ADA
-  05.1430.14ADA
- Mains Dimming
-  05.1430.40ANI
-  05.1430.14ANI
- Casambi
-  05.1430.40ACB
-  05.1430.14ACB
- Non Dimmable
-  05.1431.40A
-  05.1431.14A
- Dali Version
-  05.1431.40ADA
-  05.1431.14ADA
- Mains Dimming
-  05.1431.40ANI
-  05.1431.14ANI
- Casambi
-  05.1431.40ACB
-  05.1431.14ACB
- Non Dimmable
-  05.1432.40A
-  05.1432.14A
- Dali Version
-  05.1432.40ADA
-  05.1432.14ADA
- Mains Dimming
-  05.1432.40ANI
-  05.1432.14ANI
- Casambi
-  05.1432.40ACB
-  05.1432.14ACB

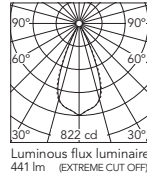









































Beam Angle: 45°

h(m)	E(lx)	D(m)
1	822	0.83
2	205	1.67
3	91	2.50
4	51	3.34
5	33	4.17

@White (40)

Optic Wide Flood 3000K

-  Non Dimmable
-  03.7304.40A
-  03.7304.14A
- Dali Version
-  03.7304.40ADA
-  03.7304.14ADA
- Mains Dimming
-  03.7304.40ANI
-  03.7304.14ANI
- Casambi
-  03.7304.40ACB
-  03.7304.14ACB
- Non Dimmable
-  03.7305.40A
-  03.7305.14A
- Dali Version
-  03.7305.40ADA
-  03.7305.14ADA
- Mains Dimming
-  03.7305.40ANI
-  03.7305.14ANI
- Casambi
-  03.7305.40ACB
-  03.7305.14ACB
- Non Dimmable
-  05.1435.40A
-  05.1435.14A
- Dali Version
-  05.1435.40ADA
-  05.1435.14ADA
- Mains Dimming
-  05.1435.40ANI
-  05.1435.14ANI
- Casambi
-  05.1435.40ACB
-  05.1435.14ACB
- Non Dimmable
-  05.1436.40A
-  05.1436.14A
- Dali Version
-  05.1436.40ADA
-  05.1436.14ADA
- Mains Dimming
-  05.1436.40ANI
-  05.1436.14ANI
- Casambi
-  05.1436.40ACB
-  05.1436.14ACB
- Non Dimmable
-  05.1437.40A
-  05.1437.14A
- Dali Version
-  05.1437.40ADA
-  05.1437.14ADA
- Mains Dimming
-  05.1437.40ANI
-  05.1437.14ANI
- Casambi
-  05.1437.40ACB
-  05.1437.14ACB

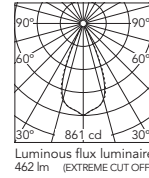





















Beam Angle: 45°

h(m)	E(lx)	D(m)
1	861	0.83
2	215	1.67
3	96	2.50
4	54	3.34
5	34	4.17

@White (40)

**Optic Medium
2700K**



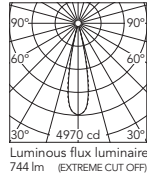

















-  Non Dimmable
03.9320.40A
03.9320.14A
Dali Version
-  03.9320.40ADA
03.9320.14ADA
Mains Dimming
-  03.9320.40ANI
03.9320.14ANI
Casambi
-  03.9320.40ACB
03.9320.14ACB
Non Dimmable
-  03.9321.40A
03.9321.14A
Dali Version
-  03.9321.40ADA
03.9321.14ADA
Mains Dimming
-  03.9321.40ANI
03.9321.14ANI
Casambi
-  03.9321.40ACB
03.9321.14ACB
Non Dimmable
-  05.1510.40A
05.1510.14A
Dali Version
-  05.1510.40ADA
05.1510.14ADA
Mains Dimming
-  05.1510.40ANI
05.1510.14ANI
Casambi
-  05.1510.40ACB
05.1510.14ACB
Non Dimmable
-  05.1511.40A
05.1511.14A
Dali Version
-  05.1511.40ADA
05.1511.14ADA
Mains Dimming
-  05.1511.40ANI
05.1511.14ANI
Casambi
-  05.1511.40ACB
05.1511.14ACB
Non Dimmable
-  05.1512.40A
05.1512.14A
Dali Version
-  05.1512.40ADA
05.1512.14ADA
Mains Dimming
-  05.1512.40ANI
05.1512.14ANI
Casambi
-  05.1512.40ACB
05.1512.14ACB



Beam Angle: 22°

h(m)	E(lx)	D(m)
1	4970	0.39
2	1243	0.78
3	552	1.17
4	311	1.56
5	199	1.95

**Optic Medium
3000K**

-  Non Dimmable
03.9330.40A
03.9330.14A
Dali Version
-  03.9330.40ADA
03.9330.14ADA
Mains Dimming
-  03.9330.40ANI
03.9330.14ANI
Casambi
-  03.9330.40ACB
03.9330.14ACB
Non Dimmable
-  03.9331.40A
03.9331.14A
Dali Version
-  03.9331.40ADA
03.9331.14ADA
Mains Dimming
-  03.9331.40ANI
03.9331.14ANI
Casambi
-  03.9331.40ACB
03.9331.14ACB
Non Dimmable
-  05.1515.40A
05.1515.14A
Dali Version
-  05.1515.40ADA
05.1515.14ADA
Mains Dimming
-  05.1515.40ANI
05.1515.14ANI
Casambi
-  05.1515.40ACB
05.1515.14ACB
Non Dimmable
-  05.1516.40A
05.1516.14A
Dali Version
-  05.1516.40ADA
05.1516.14ADA
Mains Dimming
-  05.1516.40ANI
05.1516.14ANI
Casambi
-  05.1516.40ACB
05.1516.14ACB
Non Dimmable
-  05.1517.40A
05.1517.14A
Dali Version
-  05.1517.40ADA
05.1517.14ADA
Mains Dimming
-  05.1517.40ANI
05.1517.14ANI
Casambi
-  05.1517.40ACB
05.1517.14ACB

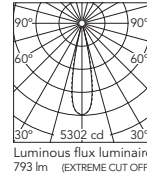

Beam Angle: 22°

h(m)	E(lx)	D(m)
1	5302	0.39
2	1325	0.78
3	589	1.17
4	331	1.56
5	212	1.95

Light Shadow Adjustable Trim 4 Spots

Light Source: Power LED DC 900 mA 10,8W - 1080 lm - 2700K/CRI 90 / 10,8W - 1140lm - 3000K/CRI 90

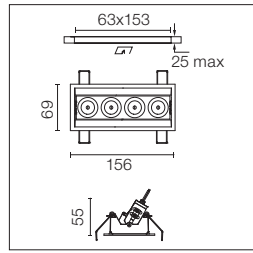

GWT 850°
 30° 30°
 0,34 Kg
 TECEE
 LED INCL
 h=75 min
 CE
 IP 20

Leuchte für Unterputzmontage mit 4 LED-Lichtquellen. Externes Netzgerät eingeschlossen (220-240V). Vorinstallationsrahmen nicht erforderlich.

E= Außenfarbe
I= Innenfarbe

Recessed integrated luminaire with 4 LED lighting spots. Remote power supply included (220-240V). Pre-Installation frame not required.

E= External Finish
I= Internal Finish

Optic Flood 2700K

- | | |
|--|---------------|
| | Non Dimmable |
| | 03.9325.40A |
| | 03.9325.14A |
| | Dali Version |
| | 03.9325.40ADA |
| | 03.9325.14ADA |
| | Mains Dimming |
| | 03.9325.40ANI |
| | 03.9325.14ANI |
| | Casambi |
| | 03.9325.40ACB |
| | 03.9325.14ACB |
| | Non Dimmable |
| | 03.9326.40A |
| | 03.9326.14A |
| | Dali Version |
| | 03.9326.40ADA |
| | 03.9326.14ADA |
| | Mains Dimming |
| | 03.9326.40ANI |
| | 03.9326.14ANI |
| | Casambi |
| | 03.9326.40ACB |
| | 03.9326.14ACB |
| | Non Dimmable |
| | 05.1520.40A |
| | 05.1520.14A |
| | Dali Version |
| | 05.1520.40ADA |
| | 05.1520.14ADA |
| | Mains Dimming |
| | 05.1520.40ANI |
| | 05.1520.14ANI |
| | Casambi |
| | 05.1520.40ACB |
| | 05.1520.14ACB |
| | Non Dimmable |
| | 05.1521.40A |
| | 05.1521.14A |
| | Dali Version |
| | 05.1521.40ADA |
| | 05.1521.14ADA |
| | Mains Dimming |
| | 05.1521.40ANI |
| | 05.1521.14ANI |
| | Casambi |
| | 05.1521.40ACB |
| | 05.1521.14ACB |
| | Non Dimmable |
| | 05.1522.40A |
| | 05.1522.14A |
| | Dali Version |
| | 05.1522.40ADA |
| | 05.1522.14ADA |
| | Mains Dimming |
| | 05.1522.40ANI |
| | 05.1522.14ANI |
| | Casambi |
| | 05.1522.40ACB |
| | 05.1522.14ACB |

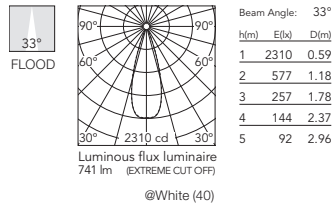





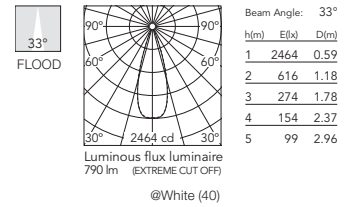















Optic Flood 3000K

- | | |
|--|---------------|
| | Non Dimmable |
| | 03.9335.40A |
| | 03.9335.14A |
| | Dali Version |
| | 03.9335.40ADA |
| | 03.9335.14ADA |
| | Mains Dimming |
| | 03.9335.40ANI |
| | 03.9335.14ANI |
| | Casambi |
| | 03.9335.40ACB |
| | 03.9335.14ACB |
| | Non Dimmable |
| | 03.9336.40A |
| | 03.9336.14A |
| | Dali Version |
| | 03.9336.40ADA |
| | 03.9336.14ADA |
| | Mains Dimming |
| | 03.9336.40ANI |
| | 03.9336.14ANI |
| | Casambi |
| | 03.9336.40ACB |
| | 03.9336.14ACB |
| | Non Dimmable |
| | 05.1525.40A |
| | 05.1525.14A |
| | Dali Version |
| | 05.1525.40ADA |
| | 05.1525.14ADA |
| | Mains Dimming |
| | 05.1525.40ANI |
| | 05.1525.14ANI |
| | Casambi |
| | 05.1525.40ACB |
| | 05.1525.14ACB |
| | Non Dimmable |
| | 05.1526.40A |
| | 05.1526.14A |
| | Dali Version |
| | 05.1526.40ADA |
| | 05.1526.14ADA |
| | Mains Dimming |
| | 05.1526.40ANI |
| | 05.1526.14ANI |
| | Casambi |
| | 05.1526.40ACB |
| | 05.1526.14ACB |
| | Non Dimmable |
| | 05.1527.40A |
| | 05.1527.14A |
| | Dali Version |
| | 05.1527.40ADA |
| | 05.1527.14ADA |
| | Mains Dimming |
| | 05.1527.40ANI |
| | 05.1527.14ANI |
| | Casambi |
| | 05.1527.40ACB |
| | 05.1527.14ACB |







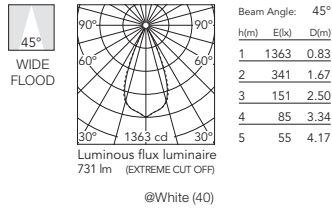















Optic Wide Flood 2700K

-  Non Dimmable
03.7308.40A
03.7308.14A
Dali Version
-  03.7308.40ADA
03.7308.14ADA
Mains Dimming
-  03.7308.40ANI
03.7308.14ANI
Casambi
-  03.7308.40ACB
03.7308.14ACB
Non Dimmable
-  03.7309.40A
03.7309.14A
Dali Version
-  03.7309.40ADA
03.7309.14ADA
Mains Dimming
-  03.7309.40ANI
03.7309.14ANI
Casambi
-  03.7309.40ACB
03.7309.14ACB
Non Dimmable
-  05.1530.40A
05.1530.14A
Dali Version
-  05.1530.40ADA
05.1530.14ADA
Mains Dimming
-  05.1530.40ANI
05.1530.14ANI
Casambi
-  05.1530.40ACB
05.1530.14ACB
Non Dimmable
-  05.1531.40A
05.1531.14A
Dali Version
-  05.1531.40ADA
05.1531.14ADA
Mains Dimming
-  05.1531.40ANI
05.1531.14ANI
Casambi
-  05.1531.40ACB
05.1531.14ACB
Non Dimmable
-  05.1532.40A
05.1532.14A
Dali Version
-  05.1532.40ADA
05.1532.14ADA
Mains Dimming
-  05.1532.40ANI
05.1532.14ANI
Casambi
-  05.1532.40ACB
05.1532.14ACB



Optic Wide Flood 3000K

-  Non Dimmable
03.7312.40A
03.7312.14A
Dali Version
-  03.7312.40ADA
03.7312.14ADA
Mains Dimming
-  03.7312.40ANI
03.7312.14ANI
Casambi
-  03.7312.40ACB
03.7312.14ACB
Non Dimmable
-  03.7313.40A
03.7313.14A
Dali Version
-  03.7313.40ADA
03.7313.14ADA
Mains Dimming
-  03.7313.40ANI
03.7313.14ANI
Casambi
-  03.7313.40ACB
03.7313.14ACB
Non Dimmable
-  05.1535.40A
05.1535.14A
Dali Version
-  05.1535.40ADA
05.1535.14ADA
Mains Dimming
-  05.1535.40ANI
05.1535.14ANI
Casambi
-  05.1535.40ACB
05.1535.14ACB
Non Dimmable
-  05.1536.40A
05.1536.14A
Dali Version
-  05.1536.40ADA
05.1536.14ADA
Mains Dimming
-  05.1536.40ANI
05.1536.14ANI
Casambi
-  05.1536.40ACB
05.1536.14ACB
Non Dimmable
-  05.1537.40A
05.1537.14A
Dali Version
-  05.1537.40ADA
05.1537.14ADA
Mains Dimming
-  05.1537.40ANI
05.1537.14ANI
Casambi
-  05.1537.40ACB
05.1537.14ACB

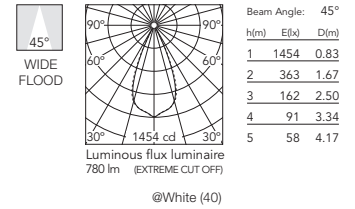

LIGHT SHADOW

Light Shadow Adjustable Trim 8 Spots

Light Source: Power LED DC 900 mA 21,6W - 2160 lm - 2700K/CRI 90 / 21,6W - 2280 lm - 3000K/CRI 90
 Mains dimming: Power LED DC 750 mA 18,5W - 1800 lm - 2700K/CRI 90 / 18,5W - 1900 lm - 3000K/CRI 90

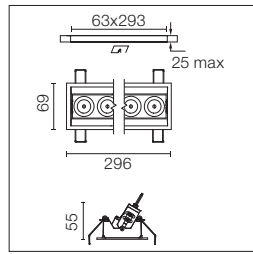

- GWT 850°
- 30°-30°
- 0,50 Kg
- h=75 min
- CE
- IP 20
- E= I=
- LED INCL
- DALI
- 10-100%
- TEGEE

Leuchte für Unterputzmontage mit 8 LED-Lichtquellen. Externes Netzgerät eingeschlossen (220-240V). Vorinstallationsrahmen nicht erforderlich.

E= Außenfarbe
I= Innenfarbe

Recessed integrated luminaire with 8 LED lighting spots. Remote power supply included (220-240V). Pre-Installation frame not required.

E= External Finish
I= Internal Finish

Optic Spot 2700K

- | | |
|--|---------------|
| | Non Dimmable |
| | 03.8900.40A |
| | 03.8900.14A |
| | Dali Version |
| | 03.8900.40ADA |
| | 03.8900.14ADA |
| | Mains Dimming |
| | 03.8900.40ANI |
| | 03.8900.14ANI |
| | Casambi |
| | 03.8900.40ACB |
| | 03.8900.14ACB |
| | Non Dimmable |
| | 03.8901.40A |
| | 03.8901.14A |
| | Dali Version |
| | 03.8901.40ADA |
| | 03.8901.14ADA |
| | Mains Dimming |
| | 03.8901.40ANI |
| | 03.8901.14ANI |
| | Casambi |
| | 03.8901.40ACB |
| | 03.8901.14ACB |
| | Non Dimmable |
| | 05.1600.40A |
| | 05.1600.14A |
| | Dali Version |
| | 05.1600.40ADA |
| | 05.1600.14ADA |
| | Mains Dimming |
| | 05.1600.40ANI |
| | 05.1600.14ANI |
| | Casambi |
| | 05.1601.40ACB |
| | 05.1601.14ACB |
| | Non Dimmable |
| | 05.1602.40A |
| | 05.1602.14A |
| | Dali Version |
| | 05.1602.40ADA |
| | 05.1602.14ADA |
| | Mains Dimming |
| | 05.1602.40ANI |
| | 05.1602.14ANI |
| | Casambi |
| | 05.1602.40ACB |
| | 05.1602.14ACB |

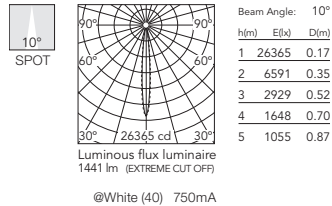
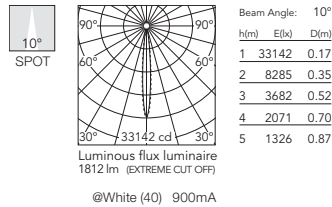





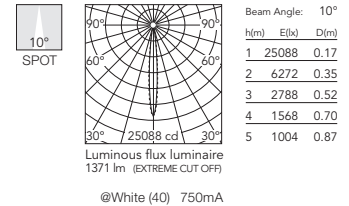
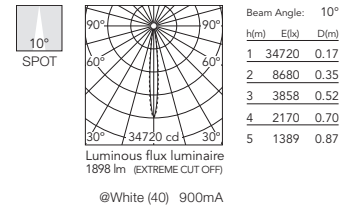















Optic Spot 3000K

- | | |
|--|---------------|
| | Non Dimmable |
| | 03.8904.40A |
| | 03.8904.14A |
| | Dali Version |
| | 03.8904.40ADA |
| | 03.8904.14ADA |
| | Mains Dimming |
| | 03.8904.40ANI |
| | 03.8904.14ANI |
| | Casambi |
| | 03.8904.40ACB |
| | 03.8904.14ACB |
| | Non Dimmable |
| | 03.8905.40A |
| | 03.8905.14A |
| | Dali Version |
| | 03.8905.40ADA |
| | 03.8905.14ADA |
| | Mains Dimming |
| | 03.8905.40ANI |
| | 03.8905.14ANI |
| | Casambi |
| | 03.8905.40ACB |
| | 03.8905.14ACB |
| | Non Dimmable |
| | 05.1605.40A |
| | 05.1605.14A |
| | Dali Version |
| | 05.1605.40ADA |
| | 05.1605.14ADA |
| | Mains Dimming |
| | 05.1605.40ANI |
| | 05.1605.14ANI |
| | Casambi |
| | 05.1605.40ACB |
| | 05.1605.14ACB |
| | Non Dimmable |
| | 05.1606.40A |
| | 05.1606.14A |
| | Dali Version |
| | 05.1606.40ADA |
| | 05.1606.14ADA |
| | Mains Dimming |
| | 05.1606.40ANI |
| | 05.1606.14ANI |
| | Casambi |
| | 05.1606.40ACB |
| | 05.1606.14ACB |
| | Non Dimmable |
| | 05.1607.40A |
| | 05.1607.14A |
| | Dali Version |
| | 05.1607.40ADA |
| | 05.1607.14ADA |
| | Mains Dimming |
| | 05.1607.40ANI |
| | 05.1607.14ANI |
| | Casambi |
| | 05.1607.40ACB |
| | 05.1607.14ACB |



**Optic Medium
2700K**

-  Non Dimmable
03.9340.40A
03.9340.14A
Dali Version
-  03.9340.40ADA
03.9340.14ADA
Mains Dimming
-  03.9340.40ANI
03.9340.14ANI
Casambi
-  03.9340.40ACB
03.9340.14ACB
Non Dimmable
-  03.9341.40A
03.9341.14A
Dali Version
-  03.9341.40ADA
03.9341.14ADA
Mains Dimming
-  03.9341.40ANI
03.9341.14ANI
Casambi
-  03.9341.40ACB
03.9341.14ACB
Non Dimmable
-  05.1610.40A
05.1610.14A
Dali Version
-  05.1610.40ADA
05.1610.14ADA
Mains Dimming
-  05.1610.40ANI
05.1610.14ANI
Casambi
-  05.1610.40ACB
05.1610.14ACB
Non Dimmable
-  05.1611.40A
05.1611.14A
Dali Version
-  05.1611.40ADA
05.1611.14ADA
Mains Dimming
-  05.1611.40ANI
05.1611.14ANI
Casambi
-  05.1611.40ACB
05.1611.14ACB
Non Dimmable
-  05.1612.40A
05.1612.14A
Dali Version
-  05.1612.40ADA
05.1612.14ADA
Mains Dimming
-  05.1612.40ANI
05.1612.14ANI
Casambi
-  05.1612.40ACB
05.1612.14ACB

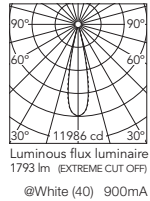

Beam Angle: 22°



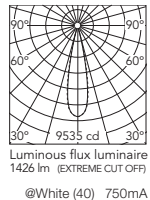

















h(m)	E(lx)	D(m)
1	11986	0.39
2	2996	0.78
3	1332	1.17
4	749	1.56
5	479	1.95



Beam Angle: 22°

h(m)	E(lx)	D(m)
1	9535	0.39
2	2384	0.78
3	1059	1.17
4	596	1.56
5	381	1.95

**Optic Medium
3000K**

-  Non Dimmable
03.9350.40A
03.9350.14A
Dali Version
-  03.9350.40ADA
03.9350.14ADA
Mains Dimming
-  03.9350.40ANI
03.9350.14ANI
Casambi
-  03.9350.40ACB
03.9350.14ACB
Non Dimmable
-  03.9351.40A
03.9351.14A
Dali Version
-  03.9351.40ADA
03.9351.14ADA
Mains Dimming
-  03.9351.40ANI
03.9351.14ANI
Casambi
-  03.9351.40ACB
03.9351.14ACB
Non Dimmable
-  05.1615.40A
05.1615.14A
Dali Version
-  05.1615.40ADA
05.1615.14ADA
Mains Dimming
-  05.1615.40ANI
05.1615.14ANI
Casambi
-  05.1615.40ACB
05.1615.14ACB
Non Dimmable
-  05.1616.40A
05.1616.14A
Dali Version
-  05.1616.40ADA
05.1616.14ADA
Mains Dimming
-  05.1616.40ANI
05.1616.14ANI
Casambi
-  05.1616.40ACB
05.1616.14ACB
Non Dimmable
-  05.1617.40A
05.1617.14A
Dali Version
-  05.1617.40ADA
05.1617.14ADA
Mains Dimming
-  05.1617.40ANI
05.1617.14ANI
Casambi
-  05.1617.40ACB
05.1617.14ACB

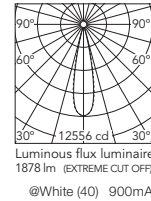

Beam Angle: 22°

h(m)	E(lx)	D(m)
1	12556	0.39
2	3139	0.78
3	1395	1.17
4	785	1.56
5	502	1.95

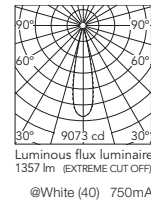

Beam Angle: 22°

h(m)	E(lx)	D(m)
1	9073	0.39
2	2268	0.78
3	1008	1.17
4	567	1.56
5	363	1.95

LIGHT SHADOW

Light Shadow Adjustable Trim 8 Spots

Light Source: Power LED DC 900 mA 21,6W - 2160 lm - 2700K/CRI 90 / 21,6W - 2280 lm - 3000K/CRI 90
 Mains dimming: Power LED DC 750 mA 18,5W - 1800 lm - 2700K/CRI 90 / 18,5W - 1900 lm - 3000K/CRI 90

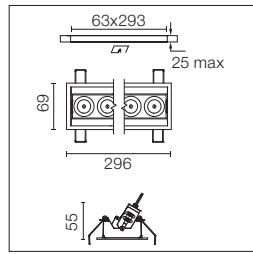

- GWT 850°
- 30°-30°
- 0,50 Kg
- h=75 min
- CE
- IP 20
- E= I=
- LED INCL
- DALI
- 10-100%
- TEGEE

Leuchte für Unterputzmontage mit 8 LED-Lichtquellen. Externes Netzgerät eingeschlossen (220-240V). Vorinstallationsrahmen nicht erforderlich.

E= Außenfarbe
I= Innenfarbe

Recessed integrated luminaire with 8 LED lighting spots. Remote power supply included (220-240V). Pre-Installation frame not required.

E= External Finish
I= Internal Finish

Optic Flood 2700K

- | | |
|--|---------------|
| | Non Dimmable |
| | 03.9345.40A |
| | 03.9345.14A |
| | Dali Version |
| | 03.9345.40ADA |
| | 03.9345.14ADA |
| | Mains Dimming |
| | 03.9345.40ANI |
| | 03.9345.14ANI |
| | Casambi |
| | 03.9345.40ACB |
| | 03.9345.14ACB |
| | Non Dimmable |
| | 03.9346.40A |
| | 03.9346.14A |
| | Dali Version |
| | 03.9346.40ADA |
| | 03.9346.14ADA |
| | Mains Dimming |
| | 03.9346.40ANI |
| | 03.9346.14ANI |
| | Casambi |
| | 03.9346.40ACB |
| | 03.9346.14ACB |
| | Non Dimmable |
| | 05.1620.40A |
| | 05.1620.14A |
| | Dali Version |
| | 05.1620.40ADA |
| | 05.1620.14ADA |
| | Mains Dimming |
| | 05.1620.40ANI |
| | 05.1620.14ANI |
| | Casambi |
| | 05.1620.40ACB |
| | 05.1620.14ACB |
| | Non Dimmable |
| | 05.1621.40A |
| | 05.1621.14A |
| | Dali Version |
| | 05.1621.40ADA |
| | 05.1621.14ADA |
| | Mains Dimming |
| | 05.1621.40ANI |
| | 05.1621.14ANI |
| | Casambi |
| | 05.1621.40ACB |
| | 05.1621.14ACB |
| | Non Dimmable |
| | 05.1622.40A |
| | 05.1622.14A |
| | Dali Version |
| | 05.1622.40ADA |
| | 05.1622.14ADA |
| | Mains Dimming |
| | 05.1622.40ANI |
| | 05.1622.14ANI |
| | Casambi |
| | 05.1622.40ACB |
| | 05.1622.14ACB |

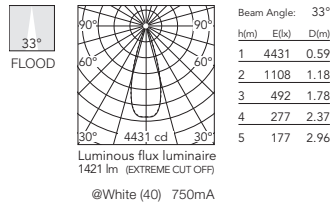
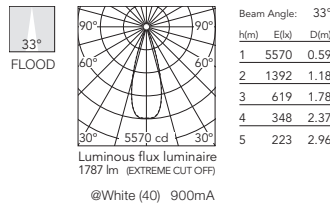





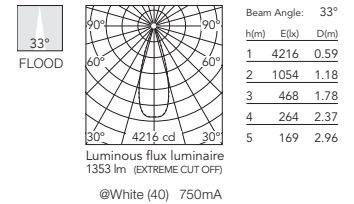
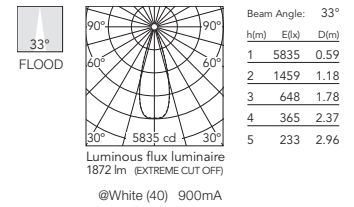



































Optic Flood 3000K

- | | |
|--|---------------|
| | Non Dimmable |
| | 03.9355.40A |
| | 03.9355.14A |
| | Dali Version |
| | 03.9355.40ADA |
| | 03.9355.14ADA |
| | Mains Dimming |
| | 03.9355.40ANI |
| | 03.9355.14ANI |
| | Casambi |
| | 03.9355.40ACB |
| | 03.9355.14ACB |
| | Non Dimmable |
| | 03.9356.40A |
| | 03.9356.14A |
| | Dali Version |
| | 03.9356.40ADA |
| | 03.9356.14ADA |
| | Mains Dimming |
| | 03.9356.40ANI |
| | 03.9356.14ANI |
| | Casambi |
| | 03.9356.40ACB |
| | 03.9356.14ACB |
| | Non Dimmable |
| | 05.1625.40A |
| | 05.1625.14A |
| | Dali Version |
| | 05.1625.40ADA |
| | 05.1625.14ADA |
| | Mains Dimming |
| | 05.1625.40ANI |
| | 05.1625.14ANI |
| | Casambi |
| | 05.1625.40ACB |
| | 05.1625.14ACB |
| | Non Dimmable |
| | 05.1626.40A |
| | 05.1626.14A |
| | Dali Version |
| | 05.1626.40ADA |
| | 05.1626.14ADA |
| | Mains Dimming |
| | 05.1626.40ANI |
| | 05.1626.14ANI |
| | Casambi |
| | 05.1626.40ACB |
| | 05.1626.14ACB |
| | Non Dimmable |
| | 05.1627.40A |
| | 05.1627.14A |
| | Dali Version |
| | 05.1627.40ADA |
| | 05.1627.14ADA |
| | Mains Dimming |
| | 05.1627.40ANI |
| | 05.1627.14ANI |
| | Casambi |
| | 05.1627.40ACB |
| | 05.1627.14ACB |







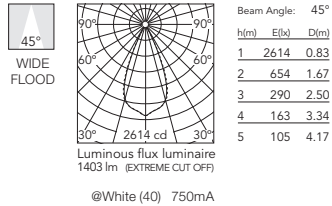
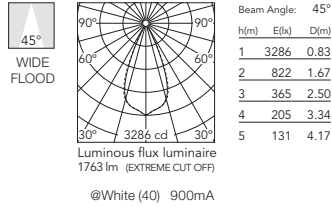



































Optic Wide Flood 2700K

-  Non Dimmable
-  03.7316.40A
-  03.7316.14A
- Dali Version
-  03.7316.40ADA
-  03.7316.14ADA
- Mains Dimming
-  03.7316.40ANI
-  03.7316.14ANI
- Casambi
-  03.7316.40ACB
-  03.7316.14ACB
- Non Dimmable
-  03.7317.40A
-  03.7317.14A
- Dali Version
-  03.7317.40ADA
-  03.7317.14ADA
- Mains Dimming
-  03.7317.40ANI
-  03.7317.14ANI
- Casambi
-  03.7317.40ACB
-  03.7317.14ACB
- Non Dimmable
-  05.1630.40A
-  05.1630.14A
- Dali Version
-  05.1630.40ADA
-  05.1630.14ADA
- Mains Dimming
-  05.1630.40ANI
-  05.1630.14ANI
- Casambi
-  05.1630.40ACB
-  05.1630.14ACB
- Non Dimmable
-  05.1631.40A
-  05.1631.14A
- Dali Version
-  05.1631.40ADA
-  05.1631.14ADA
- Mains Dimming
-  05.1631.40ANI
-  05.1631.14ANI
- Casambi
-  05.1631.40ACB
-  05.1631.14ACB
- Non Dimmable
-  05.1632.40A
-  05.1632.14A
- Dali Version
-  05.1632.40ADA
-  05.1632.14ADA
- Mains Dimming
-  05.1632.40ANI
-  05.1632.14ANI
- Casambi
-  05.1632.40ACB
-  05.1632.14ACB



Optic Wide Flood 3000K

-  Non Dimmable
-  03.7320.40A
-  03.7320.14A
- Dali Version
-  03.7320.40ADA
-  03.7320.14ADA
- Mains Dimming
-  03.7320.40ANI
-  03.7320.14ANI
- Casambi
-  03.7320.40ACB
-  03.7320.14ACB
- Non Dimmable
-  03.7321.40A
-  03.7321.14A
- Dali Version
-  03.7321.40ADA
-  03.7321.14ADA
- Mains Dimming
-  03.7321.40ANI
-  03.7321.14ANI
- Casambi
-  03.7321.40ACB
-  03.7321.14ACB
- Non Dimmable
-  05.1635.40A
-  05.1635.14A
- Dali Version
-  05.1635.40ADA
-  05.1635.14ADA
- Mains Dimming
-  05.1635.40ANI
-  05.1635.14ANI
- Casambi
-  05.1635.40ACB
-  05.1635.14ACB
- Non Dimmable
-  05.1636.40A
-  05.1636.14A
- Dali Version
-  05.1636.40ADA
-  05.1636.14ADA
- Mains Dimming
-  05.1636.40ANI
-  05.1636.14ANI
- Casambi
-  05.1636.40ACB
-  05.1636.14ACB
- Non Dimmable
-  05.1637.40A
-  05.1637.14A
- Dali Version
-  05.1637.40ADA
-  05.1637.14ADA
- Mains Dimming
-  05.1637.40ANI
-  05.1637.14ANI
- Casambi
-  05.1637.40ACB
-  05.1637.14ACB

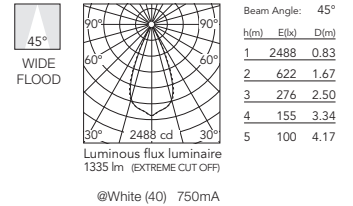
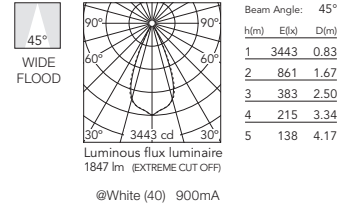

Light Shadow Adjustable Trim 12 Spots

Light Source: Power LED DC 900 mA 32,4W - 3240 lm - 2700K/CRI 90 / 32,4W - 3420 lm - 3000K/CRI 90
 Mains dimming: Power LED DC 750 mA 28W - 2710 lm - 2700K/CRI 90 / 28W - 2860 lm - 3000K/CRI 90

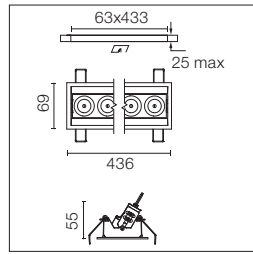

GWT 850°
 30°-30°
 0.66 Kg
 TEGEE
 DALI
 LED INCL
 h=75 min
 CE
 IP 20

Leuchte für Unterputzmontage mit 12 LED-Lichtquellen. Externes Netzgerät eingeschlossen (220-240V). Vorinstallationsrahmen nicht erforderlich.

Recessed integrated luminaire with 12 LED lighting spots. Remote power supply included (220-240V). Pre-installation frame not required.

E= Außenfarbe
 I= Innenfarbe

E= External Finish
 I= Internal Finish

Optic Spot 2700K

- E I Non Dimmable
- 03.8908.40A
- 03.8908.14A
- Dali & Push Version
- 03.8908.40ADA
- 03.8908.14ADA
- Mains Dimming
- 03.8908.40ANI
- 03.8908.14ANI
- Casambi
- 03.8908.40ACB
- 03.8908.14ACB
- Non Dimmable
- 03.8909.40A
- 03.8909.14A
- Dali & Push Version
- 03.8909.40ADA
- 03.8909.14ADA
- Mains Dimming
- 03.8909.40ANI
- 03.8909.14ANI
- Casambi
- 03.8909.40ACB
- 03.8909.14ACB
- Non Dimmable
- 05.1700.40A
- 05.1700.14A
- Dali & Push Version
- 05.1700.40ADA
- 05.1700.14ADA
- Mains Dimming
- 05.1700.40ANI
- 05.1700.14ANI
- Casambi
- 05.1700.40ACB
- 05.1700.14ACB
- Non Dimmable
- 05.1701.40A
- 05.1701.14A
- Dali & Push Version
- 05.1701.40ADA
- 05.1701.14ADA
- Mains Dimming
- 05.1701.40ANI
- 05.1701.14ANI
- Casambi
- 05.1701.40ACB
- 05.1701.14ACB
- Non Dimmable
- 05.1702.40A
- 05.1702.14A
- Dali & Push Version
- 05.1702.40ADA
- 05.1702.14ADA
- Mains Dimming
- 05.1702.40ANI
- 05.1702.14ANI
- Casambi
- 05.1702.40ACB
- 05.1702.14ACB

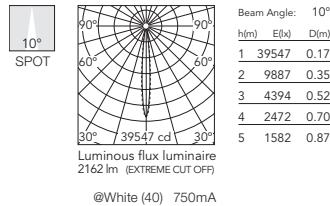
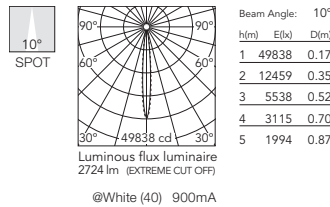





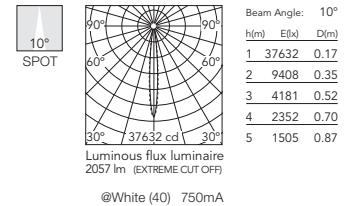
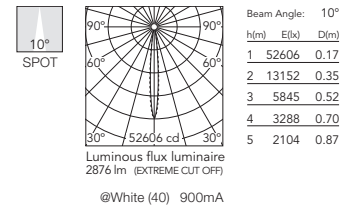















Optic Spot 3000K

- E I Non Dimmable
- 03.8912.40A
- 03.8912.14A
- Dali & Push Version
- 03.8912.40ADA
- 03.8912.14ADA
- Mains Dimming
- 03.8912.40ANI
- 03.8912.14ANI
- Casambi
- 03.8912.40ACB
- 03.8912.14ACB
- Non Dimmable
- 03.8913.40A
- 03.8913.14A
- Dali & Push Version
- 03.8913.40ADA
- 03.8913.14ADA
- Mains Dimming
- 03.8913.40ANI
- 03.8913.14ANI
- Casambi
- 03.8913.40ACB
- 03.8913.14ACB
- Non Dimmable
- 05.1705.40A
- 05.1705.14A
- Dali & Push Version
- 05.1705.40ADA
- 05.1705.14ADA
- Mains Dimming
- 05.1705.40ANI
- 05.1705.14ANI
- Casambi
- 05.1705.40ACB
- 05.1705.14ACB
- Non Dimmable
- 05.1706.40A
- 05.1706.14A
- Dali & Push Version
- 05.1706.40ADA
- 05.1706.14ADA
- Mains Dimming
- 05.1706.40ANI
- 05.1706.14ANI
- Casambi
- 05.1706.40ACB
- 05.1706.14ACB
- Non Dimmable
- 05.1707.40A
- 05.1707.14A
- Dali & Push Version
- 05.1707.40ADA
- 05.1707.14ADA
- Mains Dimming
- 05.1707.40ANI
- 05.1707.14ANI
- Casambi
- 05.1707.40ACB
- 05.1707.14ACB



**Optic Medium
2700K**

-  Non Dimmable
03.9360.40A
03.9360.14A
Dali & Push Version
-  03.9360.40ADA
03.9360.14ADA
Mains Dimming
-  03.9360.40ANI
03.9360.14ANI
Casambi
-  03.9360.40ACB
03.9360.14ACB
Non Dimmable
-  03.9361.40A
03.9361.14A
Dali & Push Version
-  03.9361.40ADA
03.9361.14ADA
Mains Dimming
-  03.9361.40ANI
03.9361.14ANI
Casambi
-  03.9361.40ACB
03.9361.14ACB
Non Dimmable
-  05.1710.40A
05.1710.14A
Dali & Push Version
-  05.1710.40ADA
05.1710.14ADA
Mains Dimming
-  05.1710.40ANI
05.1710.14ANI
Casambi
-  05.1710.40ACB
05.1710.14ACB
Non Dimmable
-  05.1711.40A
05.1711.14A
Dali & Push Version
-  05.1711.40ADA
05.1711.14ADA
Mains Dimming
-  05.1711.40ANI
05.1711.14ANI
Casambi
-  05.1711.40ACB
05.1711.14ACB
Non Dimmable
-  05.1712.40A
05.1712.14A
Dali & Push Version
-  05.1712.40ADA
05.1712.14ADA
Mains Dimming
-  05.1712.40ANI
05.1712.14ANI
Casambi
-  05.1712.40ACB
05.1712.14ACB

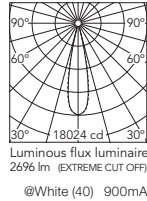

Beam Angle: 22°



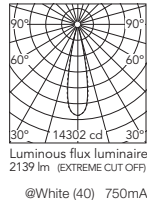

















h(m)	E(lx)	D(m)
1	18024	0.39
2	4506	0.78
3	2003	1.17
4	1126	1.56
5	721	1.95



Beam Angle: 22°

h(m)	E(lx)	D(m)
1	14302	0.39
2	3576	0.78
3	1589	1.17
4	894	1.56
5	572	1.95

**Optic Medium
3000K**

-  Non Dimmable
03.9370.40A
03.9370.14A
Dali & Push Version
-  03.9370.40ADA
03.9370.14ADA
Mains Dimming
-  03.9370.40ANI
03.9370.14ANI
Casambi
-  03.9370.40ACB
03.9370.14ACB
Non Dimmable
-  03.9371.40A
03.9371.14A
Dali & Push Version
-  03.9371.40ADA
03.9371.14ADA
Mains Dimming
-  03.9371.40ANI
03.9371.14ANI
Casambi
-  03.9371.40ACB
03.9371.14ACB
Non Dimmable
-  05.1715.40A
05.1715.14A
Dali & Push Version
-  05.1715.40ADA
05.1715.14ADA
Mains Dimming
-  05.1715.40ANI
05.1715.14ANI
Casambi
-  05.1715.40ACB
05.1715.14ACB
Non Dimmable
-  05.1716.40A
05.1716.14A
Dali & Push Version
-  05.1716.40ADA
05.1716.14ADA
Mains Dimming
-  05.1716.40ANI
05.1716.14ANI
Casambi
-  05.1716.40ACB
05.1716.14ACB
Non Dimmable
-  05.1717.40A
05.1717.14A
Dali & Push Version
-  05.1717.40ADA
05.1717.14ADA
Mains Dimming
-  05.1717.40ANI
05.1717.14ANI
Casambi
-  05.1717.40ACB
05.1717.14ACB

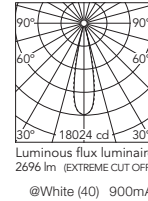

Beam Angle: 22°

h(m)	E(lx)	D(m)
1	18024	0.39
2	4506	0.78
3	2003	1.17
4	1126	1.56
5	721	1.95

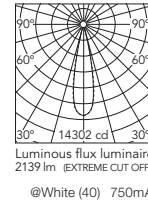

Beam Angle: 22°

h(m)	E(lx)	D(m)
1	14302	0.39
2	3576	0.78
3	1589	1.17
4	894	1.56
5	572	1.95

LIGHT SHADOW

Light Shadow Adjustable Trim 12 Spots

Light Source: Power LED DC 900 mA 32,4W - 3240 lm - 2700K/CRI 90 / 32,4W - 3420 lm - 3000K/CRI 90
 Mains dimming: Power LED DC 750 mA 28W - 2710 lm - 2700K/CRI 90 / 28W - 2860 lm - 3000K/CRI 90

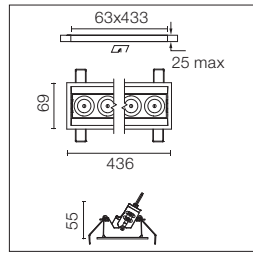

- GWT 850°
- 30°-30°
- 0.66 Kg
- TEGEE
- DALI LED INCL
- h=75 min
- CE
- IP 20

Leuchte für Unterputzmontage mit 12 LED-Lichtquellen. Externes Netzgerät eingeschlossen (220-240V). Vorinstallationsrahmen nicht erforderlich.

Recessed integrated luminaire with 12 LED lighting spots. Remote power supply included (220-240V). Pre-installation frame not required.

E= Außenfarbe
I= Innenfarbe

E= External Finish
I= Internal Finish

Optic Flood 2700K

- | | |
|--|---------------------|
| | Non Dimmable |
| | 03.9365.40A |
| | 03.9365.14A |
| | Dali & Push Version |
| | 03.9365.40ADA |
| | 03.9365.14ADA |
| | Mains Dimming |
| | 03.9365.40ANI |
| | 03.9365.14ANI |
| | Casambi |
| | 03.9365.40ACB |
| | 03.9365.14ACB |
| | Non Dimmable |
| | 03.9366.40A |
| | 03.9366.14A |
| | Dali & Push Version |
| | 03.9366.40ADA |
| | 03.9366.14ADA |
| | Mains Dimming |
| | 03.9366.40ANI |
| | 03.9366.14ANI |
| | Casambi |
| | 03.9366.40ACB |
| | 03.9366.14ACB |
| | Non Dimmable |
| | 05.1720.40A |
| | 05.1720.14A |
| | Dali & Push Version |
| | 05.1720.40ADA |
| | 05.1720.14ADA |
| | Mains Dimming |
| | 05.1720.40ANI |
| | 05.1720.14ANI |
| | Casambi |
| | 05.1720.40ACB |
| | 05.1720.14ACB |
| | Non Dimmable |
| | 05.1721.40A |
| | 05.1721.14A |
| | Dali & Push Version |
| | 05.1721.40ADA |
| | 05.1721.14ADA |
| | Mains Dimming |
| | 05.1721.40ANI |
| | 05.1721.14ANI |
| | Casambi |
| | 05.1721.40ACB |
| | 05.1721.14ACB |
| | Non Dimmable |
| | 05.1722.40A |
| | 05.1722.14A |
| | Dali & Push Version |
| | 05.1722.40ADA |
| | 05.1722.14ADA |
| | Mains Dimming |
| | 05.1722.40ANI |
| | 05.1722.14ANI |
| | Casambi |
| | 05.1722.40ACB |
| | 05.1722.14ACB |

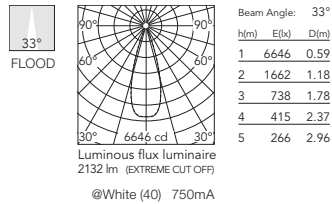
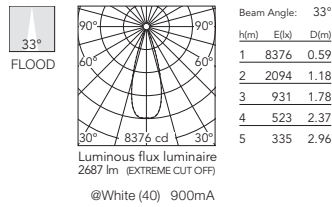





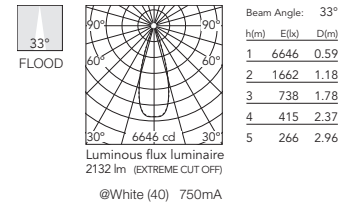
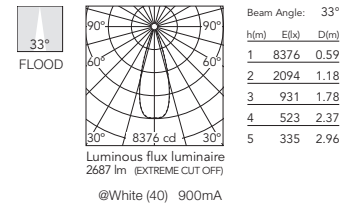













































Optic Flood 3000K

- | | |
|--|---------------------|
| | Non Dimmable |
| | 03.9375.40A |
| | 03.9375.14A |
| | Dali & Push Version |
| | 03.9375.40ADA |
| | 03.9375.14ADA |
| | Mains Dimming |
| | 03.9375.40ANI |
| | 03.9375.14ANI |
| | Casambi |
| | 03.9375.40ACB |
| | 03.9375.14ACB |
| | Non Dimmable |
| | 03.9376.40A |
| | 03.9376.14A |
| | Dali & Push Version |
| | 03.9376.40ADA |
| | 03.9376.14ADA |
| | Mains Dimming |
| | 03.9376.40ANI |
| | 03.9376.14ANI |
| | Casambi |
| | 03.9376.40ACB |
| | 03.9376.14ACB |
| | Non Dimmable |
| | 05.1725.40A |
| | 05.1725.14A |
| | Dali & Push Version |
| | 05.1725.40ADA |
| | 05.1725.14ADA |
| | Mains Dimming |
| | 05.1725.40ANI |
| | 05.1725.14ANI |
| | Casambi |
| | 05.1725.40ACB |
| | 05.1725.14ACB |
| | Non Dimmable |
| | 05.1726.40A |
| | 05.1726.14A |
| | Dali & Push Version |
| | 05.1726.40ADA |
| | 05.1726.14ADA |
| | Mains Dimming |
| | 05.1726.40ANI |
| | 05.1726.14ANI |
| | Casambi |
| | 05.1726.40ACB |
| | 05.1726.14ACB |
| | Non Dimmable |
| | 05.1727.40A |
| | 05.1727.14A |
| | Dali & Push Version |
| | 05.1727.40ADA |
| | 05.1727.14ADA |
| | Mains Dimming |
| | 05.1727.40ANI |
| | 05.1727.14ANI |
| | Casambi |
| | 05.1727.40ACB |
| | 05.1727.14ACB |







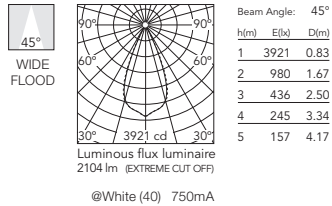
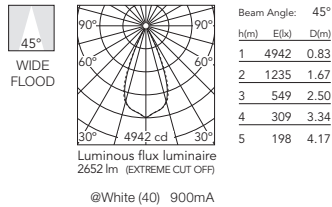













































Optic Wide Flood 2700K

-  Non Dimmable
-  03.7324.40A
-  03.7324.14A
-  Dali & Push Version
-  03.7324.40ADA
-  03.7324.14ADA
-  Mains Dimming
-  03.7324.40ANI
-  03.7324.14ANI
-  Casambi
-  03.7324.40ACB
-  03.7324.14ACB
-  Non Dimmable
-  03.7325.40A
-  03.7325.14A
-  Dali & Push Version
-  03.7325.40ADA
-  03.7325.14ADA
-  Mains Dimming
-  03.7325.40ANI
-  03.7325.14ANI
-  Casambi
-  03.7325.40ACB
-  03.7325.14ACB
-  Non Dimmable
-  05.1730.40A
-  05.1730.14A
-  Dali & Push Version
-  05.1730.40ADA
-  05.1730.14ADA
-  Mains Dimming
-  05.1730.40ANI
-  05.1730.14ANI
-  Casambi
-  05.1730.40ACB
-  05.1730.14ACB
-  Non Dimmable
-  05.1731.40A
-  05.1731.14A
-  Dali & Push Version
-  05.1731.40ADA
-  05.1731.14ADA
-  Mains Dimming
-  05.1731.40ANI
-  05.1731.14ANI
-  Casambi
-  05.1731.40ACB
-  05.1731.14ACB
-  Non Dimmable
-  05.1732.40A
-  05.1732.14A
- Dali & Push Version
- 05.1732.40ADA
- 05.1732.14ADA
- Mains Dimming
- 05.1732.40ANI
- 05.1732.14ANI
- Casambi
- 05.1732.40ACB
- 05.1732.14ACB



Optic Wide Flood 3000K

-  Non Dimmable
-  03.7328.40A
-  03.7328.14A
-  Dali & Push Version
-  03.7328.40ADA
-  03.7328.14ADA
-  Mains Dimming
-  03.7328.40ANI
-  03.7328.14ANI
-  Casambi
-  03.7328.40ACB
-  03.7328.14ACB
-  Non Dimmable
-  03.7329.40A
-  03.7329.14A
-  Dali & Push Version
-  03.7329.40ADA
-  03.7329.14ADA
-  Mains Dimming
-  03.7329.40ANI
-  03.7329.14ANI
-  Casambi
-  03.7329.40ACB
-  03.7329.14ACB
-  Non Dimmable
-  05.1735.40A
-  05.1735.14A
-  Dali & Push Version
-  05.1735.40ADA
-  05.1735.14ADA
-  Mains Dimming
-  05.1735.40ANI
-  05.1735.14ANI
-  Casambi
-  05.1735.40ACB
-  05.1735.14ACB
-  Non Dimmable
-  05.1736.40A
-  05.1736.14A
-  Dali & Push Version
-  05.1736.40ADA
-  05.1736.14ADA
-  Mains Dimming
-  05.1736.40ANI
-  05.1736.14ANI
-  Casambi
-  05.1736.40ACB
-  05.1736.14ACB
-  Non Dimmable
-  05.1737.40A
-  05.1737.14A
- Dali & Push Version
- 05.1737.40ADA
- 05.1737.14ADA
- Mains Dimming
- 05.1737.40ANI
- 05.1737.14ANI
- Casambi
- 05.1737.40ACB
- 05.1737.14ACB

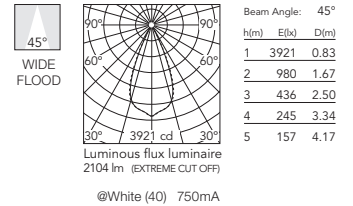
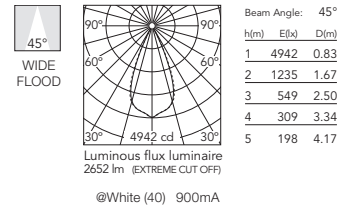

LIGHT SHADOW

Light Shadow Adjustable No Trim 2 Spots

Light Source: Power LED DC 900 mA 5,4W - 540 lm - 2700K/CRI 90 / 5,4W - 570 lm - 3000K/CRI 90

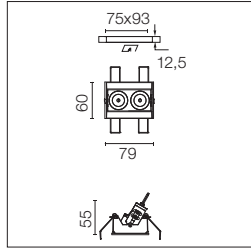

- GWT 850°
- 30°-30°
- 0,25 Kg
- h=150 min
- CE
- IP 20
- E= I=
- DALI
- LED INCL
- TECEE
- 10-100%

Leuchte für Unterputzmontage mit 2 LED-Lichtquellen. Externes Netzgerät eingeschlossen (220-240V). Vorinstallationsrahmen. Muss separat bestellt werden.

E= Außenfarbe
I= Innenfarbe

Recessed integrated luminaire with 2 LED lighting spots. Remote power supply included (220-240V). It requires a pre-installation frame, to be ordered separately.

E= External Finish
I= Internal Finish

Optic Spot 2700K

- | E | I | Non Dimmable |
|---|---|---------------|
| | | 03.8916.40A |
| | | 03.8916.14A |
| | | Dali Version |
| | | 03.8916.40ADA |
| | | 03.8916.14ADA |
| | | Mains Dimming |
| | | 03.8916.40ANI |
| | | 03.8916.14ANI |
| | | Casambi |
| | | 03.8916.40ACB |
| | | 03.8916.14ACB |
| | | Non Dimmable |
| | | 03.8917.40A |
| | | 03.8917.14A |
| | | Dali Version |
| | | 03.8917.40ADA |
| | | 03.8917.14ADA |
| | | Mains Dimming |
| | | 03.8917.40ANI |
| | | 03.8917.14ANI |
| | | Casambi |
| | | 03.8917.40ACB |
| | | 03.8917.14ACB |
| | | Non Dimmable |
| | | 05.1440.40A |
| | | 05.1440.14A |
| | | Dali Version |
| | | 05.1440.40ADA |
| | | 05.1440.14ADA |
| | | Mains Dimming |
| | | 05.1440.40ANI |
| | | 05.1440.14ANI |
| | | Casambi |
| | | 05.1440.40ACB |
| | | 05.1440.14ACB |
| | | Non Dimmable |
| | | 05.1441.40A |
| | | 05.1441.14A |
| | | Dali Version |
| | | 05.1441.40ADA |
| | | 05.1441.14ADA |
| | | Mains Dimming |
| | | 05.1441.40ANI |
| | | 05.1441.14ANI |
| | | Casambi |
| | | 05.1441.40ACB |
| | | 05.1441.14ACB |
| | | Non Dimmable |
| | | 05.1442.40A |
| | | 05.1442.14A |
| | | Dali Version |
| | | 05.1442.40ADA |
| | | 05.1442.14ADA |
| | | Mains Dimming |
| | | 05.1442.40ANI |
| | | 05.1442.14ANI |
| | | Casambi |
| | | 05.1442.40ACB |
| | | 05.1442.14ACB |

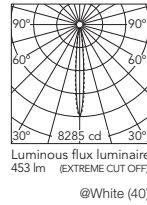





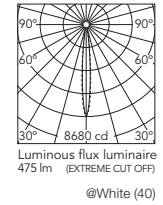















Optic Spot 3000K

- | E | I | Non Dimmable |
|---|---|---------------|
| | | 03.8920.40A |
| | | 03.8920.14A |
| | | Dali Version |
| | | 03.8920.40ADA |
| | | 03.8920.14ADA |
| | | Mains Dimming |
| | | 03.8920.40ANI |
| | | 03.8920.14ANI |
| | | Casambi |
| | | 03.8920.40ACB |
| | | 03.8920.14ACB |
| | | Non Dimmable |
| | | 03.8921.40A |
| | | 03.8921.14A |
| | | Dali Version |
| | | 03.8921.40ADA |
| | | 03.8921.14ADA |
| | | Mains Dimming |
| | | 03.8921.40ANI |
| | | 03.8921.14ANI |
| | | Casambi |
| | | 03.8921.40ACB |
| | | 03.8921.14ACB |
| | | Non Dimmable |
| | | 05.1445.40A |
| | | 05.1445.14A |
| | | Dali Version |
| | | 05.1445.40ADA |
| | | 05.1445.14ADA |
| | | Mains Dimming |
| | | 05.1445.40ANI |
| | | 05.1445.14ANI |
| | | Casambi |
| | | 05.1445.40ACB |
| | | 05.1445.14ACB |
| | | Non Dimmable |
| | | 05.1446.40A |
| | | 05.1446.14A |
| | | Dali Version |
| | | 05.1446.40ADA |
| | | 05.1446.14ADA |
| | | Mains Dimming |
| | | 05.1446.40ANI |
| | | 05.1446.14ANI |
| | | Casambi |
| | | 05.1446.40ACB |
| | | 05.1446.14ACB |
| | | Non Dimmable |
| | | 05.1447.40A |
| | | 05.1447.14A |
| | | Dali Version |
| | | 05.1447.40ADA |
| | | 05.1447.14ADA |
| | | Mains Dimming |
| | | 05.1447.40ANI |
| | | 05.1447.14ANI |
| | | Casambi |
| | | 05.1447.40ACB |
| | | 05.1447.14ACB |



**Optic Medium
2700K**



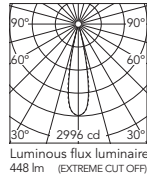

















- | | |
|--|---|
|  | Non Dimmable |
|  | 03.9400.40A
03.9400.14A
Dali Version |
|  | 03.9400.40ADA
03.9400.14ADA
Mains Dimming |
|  | 03.9400.40ANI
03.9400.14ANI
Casambi |
|  | 03.9400.40ACB
03.9400.14ACB
Non Dimmable |
|  | 03.9401.40A
03.9401.14A
Dali Version |
|  | 03.9401.40ADA
03.9401.14ADA
Mains Dimming |
|  | 03.9401.40ANI
03.9401.14ANI
Casambi |
|  | 03.9401.40ACB
03.9401.14ACB
Non Dimmable |
|  | 05.1450.40A
05.1450.14A
Dali Version |
|  | 05.1450.40ADA
05.1450.14ADA
Mains Dimming |
|  | 05.1450.40ANI
05.1450.14ANI
Casambi |
|  | 05.1450.40ACB
05.1450.14ACB
Non Dimmable |
|  | 05.1451.40A
05.1451.14A
Dali Version |
|  | 05.1451.40ADA
05.1451.14ADA
Mains Dimming |
|  | 05.1451.40ANI
05.1451.14ANI
Casambi |
|  | 05.1451.40ACB
05.1451.14ACB
Non Dimmable |
|  | 05.1452.40A
05.1452.14A
Dali Version |
|  | 05.1452.40ADA
05.1452.14ADA
Mains Dimming |
|  | 05.1452.40ANI
05.1452.14ANI
Casambi |
|  | 05.1452.40ACB
05.1452.14ACB |



Beam Angle: 22°

h(m)	E(lx)	D(m)
1	2996	0.39
2	749	0.78
3	333	1.17
4	187	1.56
5	120	1.95

**Optic Medium
3000K**

- | | |
|---|---|
|  | Non Dimmable |
|  | 03.9410.40A
03.9410.14A
Dali Version |
|  | 03.9410.40ADA
03.9410.14ADA
Mains Dimming |
|  | 03.9410.40ANI
03.9410.14ANI
Casambi |
|  | 03.9410.40ACB
03.9410.14ACB
Non Dimmable |
|  | 03.9411.40A
03.9411.14A
Dali Version |
|  | 03.9411.40ADA
03.9411.14ADA
Mains Dimming |
|  | 03.9411.40ANI
03.9411.14ANI
Casambi |
|  | 03.9411.40ACB
03.9411.14ACB
Non Dimmable |
|  | 05.1455.40A
05.1455.14A
Dali Version |
|  | 05.1455.40ADA
05.1455.14ADA
Mains Dimming |
|  | 05.1455.40ANI
05.1455.14ANI
Casambi |
|  | 05.1455.40ACB
05.1455.14ACB
Non Dimmable |
|  | 05.1456.40A
05.1456.14A
Dali Version |
|  | 05.1456.40ADA
05.1456.14ADA
Mains Dimming |
|  | 05.1456.40ANI
05.1456.14ANI
Casambi |
|  | 05.1456.40ACB
05.1456.14ACB
Non Dimmable |
|  | 05.1457.40A
05.1457.14A
Dali Version |
|  | 05.1457.40ADA
05.1457.14ADA
Mains Dimming |
|  | 05.1457.40ANI
05.1457.14ANI
Casambi |
|  | 05.1457.40ACB
05.1457.14ACB |

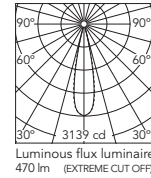

Beam Angle: 22°

h(m)	E(lx)	D(m)
1	3139	0.39
2	785	0.78
3	349	1.17
4	196	1.56
5	126	1.95

LIGHT SHADOW

Light Shadow Adjustable No Trim 2 Spots

Light Source: Power LED DC 900 mA 5,4W - 540 lm - 2700K/CRI 90 / 5,4W - 570 lm - 3000K/CRI 90

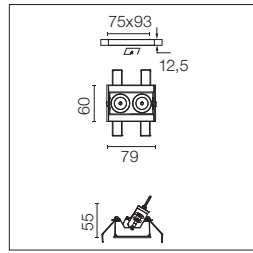

- GWT 850°
- E=I
- 30°-30°
- 0.03
- 10-100%
- DALI
- LED INCL
- 0,25 Kg
- TECEE
- h=150 min
- LED INCL
- CE
- IP 20

Leuchte für Unterputzmontage mit 2 LED-Lichtquellen. Externes Netzgerät eingeschlossen (220-240V). Vorinstallationsrahmen. Muss separat bestellt werden.

E= Außenfarbe
I= Innenfarbe

Recessed integrated luminaire with 2 LED lighting spots. Remote power supply included (220-240V). It requires a pre-installation frame, to be ordered separately.

E= External Finish
I= Internal Finish

Optic Flood 2700K

- | | |
|--|---------------|
| | Non Dimmable |
| | 03.9405.40A |
| | 03.9405.14A |
| | Dali Version |
| | 03.9405.40ADA |
| | 03.9405.14ADA |
| | Mains Dimming |
| | 03.9405.40ANI |
| | 03.9405.14ANI |
| | Casambi |
| | 03.9405.40ACB |
| | 03.9405.14ACB |
| | Non Dimmable |
| | 03.9406.40A |
| | 03.9406.14A |
| | Dali Version |
| | 03.9406.40ADA |
| | 03.9406.14ADA |
| | Mains Dimming |
| | 03.9406.40ANI |
| | 03.9406.14ANI |
| | Casambi |
| | 03.9406.40ACB |
| | 03.9406.14ACB |
| | Non Dimmable |
| | 05.1460.40A |
| | 05.1460.14A |
| | Dali Version |
| | 05.1460.40ADA |
| | 05.1460.14ADA |
| | Mains Dimming |
| | 05.1460.40ANI |
| | 05.1460.14ANI |
| | Casambi |
| | 05.1460.40ACB |
| | 05.1460.14ACB |
| | Non Dimmable |
| | 05.1461.40A |
| | 05.1461.14A |
| | Dali Version |
| | 05.1461.40ADA |
| | 05.1461.14ADA |
| | Mains Dimming |
| | 05.1461.40ANI |
| | 05.1461.14ANI |
| | Casambi |
| | 05.1461.40ACB |
| | 05.1461.14ACB |
| | Non Dimmable |
| | 05.1462.40A |
| | 05.1462.14A |
| | Dali Version |
| | 05.1462.40ADA |
| | 05.1462.14ADA |
| | Mains Dimming |
| | 05.1462.40ANI |
| | 05.1462.14ANI |
| | Casambi |
| | 05.1462.40ACB |
| | 05.1462.14ACB |

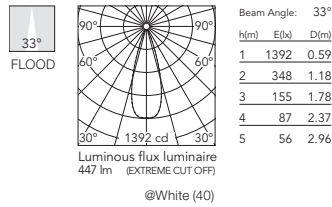





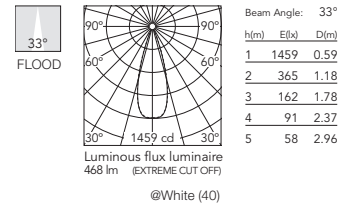















Optic Flood 3000K

- | | |
|--|---------------|
| | Non Dimmable |
| | 03.9415.40A |
| | 03.9415.14A |
| | Dali Version |
| | 03.9415.40ADA |
| | 03.9415.14ADA |
| | Mains Dimming |
| | 03.9415.40ANI |
| | 03.9415.14ANI |
| | Casambi |
| | 03.9415.40ACB |
| | 03.9415.14ACB |
| | Non Dimmable |
| | 03.9416.40A |
| | 03.9416.14A |
| | Dali Version |
| | 03.9416.40ADA |
| | 03.9416.14ADA |
| | Mains Dimming |
| | 03.9416.40ANI |
| | 03.9416.14ANI |
| | Casambi |
| | 03.9416.40ACB |
| | 03.9416.14ACB |
| | Non Dimmable |
| | 05.1465.40A |
| | 05.1465.14A |
| | Dali Version |
| | 05.1465.40ADA |
| | 05.1465.14ADA |
| | Mains Dimming |
| | 05.1465.40ANI |
| | 05.1465.14ANI |
| | Casambi |
| | 05.1465.40ACB |
| | 05.1465.14ACB |
| | Non Dimmable |
| | 05.1466.40A |
| | 05.1466.14A |
| | Dali Version |
| | 05.1466.40ADA |
| | 05.1466.14ADA |
| | Mains Dimming |
| | 05.1466.40ANI |
| | 05.1466.14ANI |
| | Casambi |
| | 05.1466.40ACB |
| | 05.1466.14ACB |
| | Non Dimmable |
| | 05.1467.40A |
| | 05.1467.14A |
| | Dali Version |
| | 05.1467.40ADA |
| | 05.1467.14ADA |
| | Mains Dimming |
| | 05.1467.40ANI |
| | 05.1467.14ANI |
| | Casambi |
| | 05.1467.40ACB |
| | 05.1467.14ACB |



Optic Wide Flood 2700K

-  Non Dimmable
03.7350.40A
03.7350.14A
Dali Version
-  03.7350.40ADA
03.7350.14ADA
Mains Dimming
-  03.7350.40ANI
03.7350.14ANI
Casambi
-  03.7350.40ACB
03.7350.14ACB
Non Dimmable
-  03.7351.40A
03.7351.14A
Dali Version
-  03.7351.40ADA
03.7351.14ADA
Mains Dimming
-  03.7351.40ANI
03.7351.14ANI
Casambi
-  03.7351.40ACB
03.7351.14ACB
Non Dimmable
-  05.1470.40A
05.1470.14A
Dali Version
-  05.1470.40ADA
05.1470.14ADA
Mains Dimming
-  05.1470.40ANI
05.1470.14ANI
Casambi
-  05.1470.40ACB
05.1470.14ACB
Non Dimmable
-  05.1471.40A
05.1471.14A
Dali Version
-  05.1471.40ADA
05.1471.14ADA
Mains Dimming
-  05.1471.40ANI
05.1471.14ANI
Casambi
-  05.1471.40ACB
05.1471.14ACB
Non Dimmable
-  05.1472.40A
05.1472.14A
Dali Version
-  05.1472.40ADA
05.1472.14ADA
Mains Dimming
-  05.1472.40ANI
05.1472.14ANI
Casambi
-  05.1472.40ACB
05.1472.14ACB

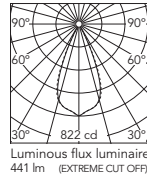





















Beam Angle: 45°

h(m)	E(lx)	D(m)
1	822	0.83
2	205	1.67
3	91	2.50
4	51	3.34
5	33	4.17

@White (40)

Optic Wide Flood 3000K

-  Non Dimmable
03.7354.40A
03.7354.14A
Dali Version
-  03.7354.40ADA
03.7354.14ADA
Mains Dimming
-  03.7354.40ANI
03.7354.14ANI
Casambi
-  03.7354.40ACB
03.7354.14ACB
Non Dimmable
-  03.7355.40A
03.7355.14A
Dali Version
-  03.7355.40ADA
03.7355.14ADA
Mains Dimming
-  03.7355.40ANI
03.7355.14ANI
Casambi
-  03.7355.40ACB
03.7355.14ACB
Non Dimmable
-  05.1475.40A
05.1475.14A
Dali Version
-  05.1475.40ADA
05.1475.14ADA
Mains Dimming
-  05.1475.40ANI
05.1475.14ANI
Casambi
-  05.1475.40ACB
05.1475.14ACB
Non Dimmable
-  05.1476.40A
05.1476.14A
Dali Version
-  05.1476.40ADA
05.1476.14ADA
Mains Dimming
-  05.1476.40ANI
05.1476.14ANI
Casambi
-  05.1476.40ACB
05.1476.14ACB
Non Dimmable
-  05.1477.40A
05.1477.14A
Dali Version
-  05.1477.40ADA
05.1477.14ADA
Mains Dimming
-  05.1477.40ANI
05.1477.14ANI
Casambi
-  05.1477.40ACB
05.1477.14ACB

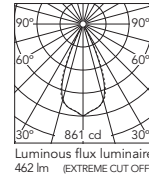

Beam Angle: 45°

h(m)	E(lx)	D(m)
1	861	0.83
2	215	1.67
3	96	2.50
4	54	3.34
5	34	4.17

@White (40)

LIGHT SHADOW

Light Shadow Adjustable No Trim 4 Spots

Light Source: Power LED DC 900 mA 10,8W - 1080 lm - 2700K/CRI 90 / 10,8W - 1140lm - 3000K/CRI 90

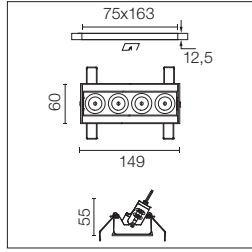

- GWT 850°
- DALI
- LED INCL
- 30° 30°
- TECEE
- 0.34 Kg
- h=75 min
- CE
- IP 20

Leuchte für Unterputzmontage mit 4 LED-Lichtquellen. Externes Netzgerät eingeschlossen (220-240V). Vorinstallationsrahmen. Muss separat bestellt werden.

E= Außenfarbe
I= Innenfarbe

Recessed integrated luminaire with 4 LED lighting spots. Remote power supply included (220-240V). It requires a pre-installation frame, to be ordered separately.

E= External Finish
I= Internal Finish.

Optic Spot 2700K

- | E | I | Non Dimmable |
|--------------------------|--------------------------|---------------|
| <input type="checkbox"/> | <input type="checkbox"/> | 03.8924.40A |
| <input type="checkbox"/> | <input type="checkbox"/> | 03.8924.14A |
| <input type="checkbox"/> | <input type="checkbox"/> | Dali Version |
| <input type="checkbox"/> | <input type="checkbox"/> | 03.8924.40ADA |
| <input type="checkbox"/> | <input type="checkbox"/> | 03.8924.14ADA |
| <input type="checkbox"/> | <input type="checkbox"/> | Mains Dimming |
| <input type="checkbox"/> | <input type="checkbox"/> | 03.8924.40ANI |
| <input type="checkbox"/> | <input type="checkbox"/> | 03.8924.14ANI |
| <input type="checkbox"/> | <input type="checkbox"/> | Casambi |
| <input type="checkbox"/> | <input type="checkbox"/> | 03.8924.40ACB |
| <input type="checkbox"/> | <input type="checkbox"/> | 03.8924.14ACB |
| <input type="checkbox"/> | <input type="checkbox"/> | Non Dimmable |
| <input type="checkbox"/> | <input type="checkbox"/> | 03.8925.40A |
| <input type="checkbox"/> | <input type="checkbox"/> | 03.8925.14A |
| <input type="checkbox"/> | <input type="checkbox"/> | Dali Version |
| <input type="checkbox"/> | <input type="checkbox"/> | 03.8925.40ADA |
| <input type="checkbox"/> | <input type="checkbox"/> | 03.8925.14ADA |
| <input type="checkbox"/> | <input type="checkbox"/> | Mains Dimming |
| <input type="checkbox"/> | <input type="checkbox"/> | 03.8925.40ANI |
| <input type="checkbox"/> | <input type="checkbox"/> | 03.8925.14ANI |
| <input type="checkbox"/> | <input type="checkbox"/> | Casambi |
| <input type="checkbox"/> | <input type="checkbox"/> | 03.8925.40ACB |
| <input type="checkbox"/> | <input type="checkbox"/> | 03.8925.14ACB |
| <input type="checkbox"/> | <input type="checkbox"/> | Non Dimmable |
| <input type="checkbox"/> | <input type="checkbox"/> | 05.1540.40A |
| <input type="checkbox"/> | <input type="checkbox"/> | 05.1540.14A |
| <input type="checkbox"/> | <input type="checkbox"/> | Dali Version |
| <input type="checkbox"/> | <input type="checkbox"/> | 05.1540.40ADA |
| <input type="checkbox"/> | <input type="checkbox"/> | 05.1540.14ADA |
| <input type="checkbox"/> | <input type="checkbox"/> | Mains Dimming |
| <input type="checkbox"/> | <input type="checkbox"/> | 05.1540.40ANI |
| <input type="checkbox"/> | <input type="checkbox"/> | 05.1540.14ANI |
| <input type="checkbox"/> | <input type="checkbox"/> | Casambi |
| <input type="checkbox"/> | <input type="checkbox"/> | 05.1540.40ACB |
| <input type="checkbox"/> | <input type="checkbox"/> | 05.1540.14ACB |
| <input type="checkbox"/> | <input type="checkbox"/> | Non Dimmable |
| <input type="checkbox"/> | <input type="checkbox"/> | 05.1541.40A |
| <input type="checkbox"/> | <input type="checkbox"/> | 05.1541.14A |
| <input type="checkbox"/> | <input type="checkbox"/> | Dali Version |
| <input type="checkbox"/> | <input type="checkbox"/> | 05.1541.40ADA |
| <input type="checkbox"/> | <input type="checkbox"/> | 05.1541.14ADA |
| <input type="checkbox"/> | <input type="checkbox"/> | Mains Dimming |
| <input type="checkbox"/> | <input type="checkbox"/> | 05.1541.40ANI |
| <input type="checkbox"/> | <input type="checkbox"/> | 05.1541.14ANI |
| <input type="checkbox"/> | <input type="checkbox"/> | Casambi |
| <input type="checkbox"/> | <input type="checkbox"/> | 05.1541.40ACB |
| <input type="checkbox"/> | <input type="checkbox"/> | 05.1541.14ACB |
| <input type="checkbox"/> | <input type="checkbox"/> | Non Dimmable |
| <input type="checkbox"/> | <input type="checkbox"/> | 05.1542.40A |
| <input type="checkbox"/> | <input type="checkbox"/> | 05.1542.14A |
| <input type="checkbox"/> | <input type="checkbox"/> | Dali Version |
| <input type="checkbox"/> | <input type="checkbox"/> | 05.1542.40ADA |
| <input type="checkbox"/> | <input type="checkbox"/> | 05.1542.14ADA |
| <input type="checkbox"/> | <input type="checkbox"/> | Mains Dimming |
| <input type="checkbox"/> | <input type="checkbox"/> | 05.1542.40ANI |
| <input type="checkbox"/> | <input type="checkbox"/> | 05.1542.14ANI |
| <input type="checkbox"/> | <input type="checkbox"/> | Casambi |
| <input type="checkbox"/> | <input type="checkbox"/> | 05.1542.40ACB |
| <input type="checkbox"/> | <input type="checkbox"/> | 05.1542.14ACB |

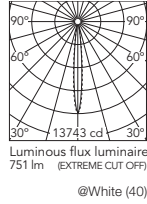

Beam Angle:	h(m)	E(lx)	D(m)
10°	1	13743	0.17
30°	2	3436	0.35
60°	3	1527	0.52
90°	4	859	0.70
120°	5	550	0.87





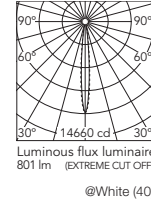















Optic Spot 3000K

- | E | I | Non Dimmable |
|--------------------------|--------------------------|---------------|
| <input type="checkbox"/> | <input type="checkbox"/> | 03.8928.40A |
| <input type="checkbox"/> | <input type="checkbox"/> | 03.8928.14A |
| <input type="checkbox"/> | <input type="checkbox"/> | Dali Version |
| <input type="checkbox"/> | <input type="checkbox"/> | 03.8928.40ADA |
| <input type="checkbox"/> | <input type="checkbox"/> | 03.8928.14ADA |
| <input type="checkbox"/> | <input type="checkbox"/> | Mains Dimming |
| <input type="checkbox"/> | <input type="checkbox"/> | 03.8928.40ANI |
| <input type="checkbox"/> | <input type="checkbox"/> | 03.8928.14ANI |
| <input type="checkbox"/> | <input type="checkbox"/> | Casambi |
| <input type="checkbox"/> | <input type="checkbox"/> | 03.8928.40ACB |
| <input type="checkbox"/> | <input type="checkbox"/> | 03.8928.14ACB |
| <input type="checkbox"/> | <input type="checkbox"/> | Non Dimmable |
| <input type="checkbox"/> | <input type="checkbox"/> | 03.8929.40A |
| <input type="checkbox"/> | <input type="checkbox"/> | 03.8929.14A |
| <input type="checkbox"/> | <input type="checkbox"/> | Dali Version |
| <input type="checkbox"/> | <input type="checkbox"/> | 03.8929.40ADA |
| <input type="checkbox"/> | <input type="checkbox"/> | 03.8929.14ADA |
| <input type="checkbox"/> | <input type="checkbox"/> | Mains Dimming |
| <input type="checkbox"/> | <input type="checkbox"/> | 03.8929.40ANI |
| <input type="checkbox"/> | <input type="checkbox"/> | 03.8929.14ANI |
| <input type="checkbox"/> | <input type="checkbox"/> | Casambi |
| <input type="checkbox"/> | <input type="checkbox"/> | 03.8929.40ACB |
| <input type="checkbox"/> | <input type="checkbox"/> | 03.8929.14ACB |
| <input type="checkbox"/> | <input type="checkbox"/> | Non Dimmable |
| <input type="checkbox"/> | <input type="checkbox"/> | 05.1545.40A |
| <input type="checkbox"/> | <input type="checkbox"/> | 05.1545.14A |
| <input type="checkbox"/> | <input type="checkbox"/> | Dali Version |
| <input type="checkbox"/> | <input type="checkbox"/> | 05.1545.40ADA |
| <input type="checkbox"/> | <input type="checkbox"/> | 05.1545.14ADA |
| <input type="checkbox"/> | <input type="checkbox"/> | Mains Dimming |
| <input type="checkbox"/> | <input type="checkbox"/> | 05.1545.40ANI |
| <input type="checkbox"/> | <input type="checkbox"/> | 05.1545.14ANI |
| <input type="checkbox"/> | <input type="checkbox"/> | Casambi |
| <input type="checkbox"/> | <input type="checkbox"/> | 05.1545.40ACB |
| <input type="checkbox"/> | <input type="checkbox"/> | 05.1545.14ACB |
| <input type="checkbox"/> | <input type="checkbox"/> | Non Dimmable |
| <input type="checkbox"/> | <input type="checkbox"/> | 05.1546.40A |
| <input type="checkbox"/> | <input type="checkbox"/> | 05.1546.14A |
| <input type="checkbox"/> | <input type="checkbox"/> | Dali Version |
| <input type="checkbox"/> | <input type="checkbox"/> | 05.1546.40ADA |
| <input type="checkbox"/> | <input type="checkbox"/> | 05.1546.14ADA |
| <input type="checkbox"/> | <input type="checkbox"/> | Mains Dimming |
| <input type="checkbox"/> | <input type="checkbox"/> | 05.1546.40ANI |
| <input type="checkbox"/> | <input type="checkbox"/> | 05.1546.14ANI |
| <input type="checkbox"/> | <input type="checkbox"/> | Casambi |
| <input type="checkbox"/> | <input type="checkbox"/> | 05.1546.40ACB |
| <input type="checkbox"/> | <input type="checkbox"/> | 05.1546.14ACB |
| <input type="checkbox"/> | <input type="checkbox"/> | Non Dimmable |
| <input type="checkbox"/> | <input type="checkbox"/> | 05.1547.40A |
| <input type="checkbox"/> | <input type="checkbox"/> | 05.1547.14A |
| <input type="checkbox"/> | <input type="checkbox"/> | Dali Version |
| <input type="checkbox"/> | <input type="checkbox"/> | 05.1547.40ADA |
| <input type="checkbox"/> | <input type="checkbox"/> | 05.1547.14ADA |
| <input type="checkbox"/> | <input type="checkbox"/> | Mains Dimming |
| <input type="checkbox"/> | <input type="checkbox"/> | 05.1547.40ANI |
| <input type="checkbox"/> | <input type="checkbox"/> | 05.1547.14ANI |
| <input type="checkbox"/> | <input type="checkbox"/> | Casambi |
| <input type="checkbox"/> | <input type="checkbox"/> | 05.1547.40ACB |
| <input type="checkbox"/> | <input type="checkbox"/> | 05.1547.14ACB |



Beam Angle:	h(m)	E(lx)	D(m)
10°	1	14660	0.17
30°	2	3665	0.35
60°	3	1629	0.52
90°	4	916	0.70
120°	5	586	0.87





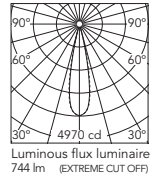















**Optic Medium
2700K**

-  Non Dimmable
03.9420.40A
03.9420.14A
Dali Version
-  03.9420.40ADA
03.9420.14ADA
Mains Dimming
-  03.9420.40ANI
03.9420.14ANI
Casambi
-  03.9420.40ACB
03.9420.14ACB
Non Dimmable
-  03.9421.40A
03.9421.14A
Dali Version
-  03.9421.40ADA
03.9421.14ADA
Mains Dimming
-  03.9421.40ANI
03.9421.14ANI
Casambi
-  03.9421.40ACB
03.9421.14ACB
Non Dimmable
-  05.1550.40A
05.1550.14A
Dali Version
-  05.1550.40ADA
05.1550.14ADA
Mains Dimming
-  05.1550.40ANI
05.1550.14ANI
Casambi
-  05.1550.40ACB
05.1550.14ACB
Non Dimmable
-  05.1551.40A
05.1551.14A
Dali Version
-  05.1551.40ADA
05.1551.14ADA
Mains Dimming
-  05.1551.40ANI
05.1551.14ANI
Casambi
-  05.1551.40ACB
05.1551.14ACB
Non Dimmable
-  05.1552.40A
05.1552.14A
Dali Version
-  05.1552.40ADA
05.1552.14ADA
Mains Dimming
-  05.1552.40ANI
05.1552.14ANI
Casambi
-  05.1552.40ACB
05.1552.14ACB
Non Dimmable



h(m)	E(lx)	D(m)
1	4970	0.39
2	1243	0.78
3	552	1.17
4	311	1.56
5	199	1.95

**Optic Medium
3000K**

-  Non Dimmable
03.9430.40A
03.9430.14A
Dali Version
-  03.9430.40ADA
03.9430.14ADA
Mains Dimming
-  03.9430.40ANI
03.9430.14ANI
Casambi
-  03.9430.40ACB
03.9430.14ACB
Non Dimmable
-  03.9431.40A
03.9431.14A
Dali Version
-  03.9431.40ADA
03.9431.14ADA
Mains Dimming
-  03.9431.40ANI
03.9431.14ANI
Casambi
-  03.9431.40ACB
03.9431.14ACB
Non Dimmable
-  05.1555.40A
05.1555.14A
Dali Version
-  05.1555.40ADA
05.1555.14ADA
Mains Dimming
-  05.1555.40ANI
05.1555.14ANI
Casambi
-  05.1555.40ACB
05.1555.14ACB
Non Dimmable
-  05.1556.40A
05.1556.14A
Dali Version
-  05.1556.40ADA
05.1556.14ADA
Mains Dimming
-  05.1556.40ANI
05.1556.14ANI
Casambi
-  05.1556.40ACB
05.1556.14ACB
Non Dimmable
-  05.1557.40A
05.1557.14A
Dali Version
-  05.1557.40ADA
05.1557.14ADA
Mains Dimming
-  05.1557.40ANI
05.1557.14ANI
Casambi
-  05.1557.40ACB
05.1557.14ACB
Non Dimmable

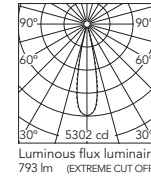

h(m)	E(lx)	D(m)
1	5302	0.39
2	1325	0.78
3	589	1.17
4	331	1.56
5	212	1.95

LIGHT SHADOW

Light Shadow Adjustable No Trim 4 Spots

Light Source: Power LED DC 900 mA 10,8W - 1080 lm - 2700K/CRI 90 / 10,8W - 1140lm - 3000K/CRI 90

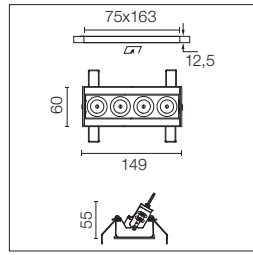

- GWT 850°
- 30° 30°
- 0.34 Kg
- h=75 min
- CE
- IP 20
- F
- 03
- DALI
- LED INCL
- TECEE
- IP 20

Leuchte für Unterputzmontage mit 4 LED-Lichtquellen. Externes Netzgerät eingeschlossen (220-240V). Vorinstallationsrahmen. Muss separat bestellt werden.

E= Außenfarbe
I= Innenfarbe

Recessed integrated luminaire with 4 LED lighting spots. Remote power supply included (220-240V). It requires a pre-installation frame, to be ordered separately.

E= External Finish
I= Internal Finish.

Optic Flood 2700K

- | E | I | Non Dimmable |
|---|---|---------------|
| | | 03.9425.40A |
| | | 03.9425.14A |
| | | Dali Version |
| | | 03.9425.40ADA |
| | | 03.9425.14ADA |
| | | Mains Dimming |
| | | 03.9425.40ANI |
| | | 03.9425.14ANI |
| | | Casambi |
| | | 03.9425.40ACB |
| | | 03.9425.14ACB |
| | | Non Dimmable |
| | | 03.9426.40A |
| | | 03.9426.14A |
| | | Dali Version |
| | | 03.9426.40ADA |
| | | 03.9426.14ADA |
| | | Mains Dimming |
| | | 03.9426.40ANI |
| | | 03.9426.14ANI |
| | | Casambi |
| | | 03.9426.40ACB |
| | | 03.9426.14ACB |
| | | Non Dimmable |
| | | 05.1560.40A |
| | | 05.1560.14A |
| | | Dali Version |
| | | 05.1560.40ADA |
| | | 05.1560.14ADA |
| | | Mains Dimming |
| | | 05.1560.40ANI |
| | | 05.1560.14ANI |
| | | Casambi |
| | | 05.1560.40ACB |
| | | 05.1560.14ACB |
| | | Non Dimmable |
| | | 05.1561.40A |
| | | 05.1561.14A |
| | | Dali Version |
| | | 05.1561.40ADA |
| | | 05.1561.14ADA |
| | | Mains Dimming |
| | | 05.1561.40ANI |
| | | 05.1561.14ANI |
| | | Casambi |
| | | 05.1561.40ACB |
| | | 05.1561.14ACB |
| | | Non Dimmable |
| | | 05.1562.40A |
| | | 05.1562.14A |
| | | Dali Version |
| | | 05.1562.40ADA |
| | | 05.1562.14ADA |
| | | Mains Dimming |
| | | 05.1562.40ANI |
| | | 05.1562.14ANI |
| | | Casambi |
| | | 05.1562.40ACB |
| | | 05.1562.14ACB |

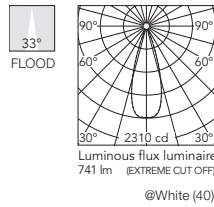

Optic Flood 3000K

- | E | I | Non Dimmable |
|---|---|---------------|
| | | 03.9435.40A |
| | | 03.9435.14A |
| | | Dali Version |
| | | 03.9435.40ADA |
| | | 03.9435.14ADA |
| | | Mains Dimming |
| | | 03.9435.40ANI |
| | | 03.9435.14ANI |
| | | Casambi |
| | | 03.9435.40ACB |
| | | 03.9435.14ACB |
| | | Non Dimmable |
| | | 03.9436.40A |
| | | 03.9436.14A |
| | | Dali Version |
| | | 03.9436.40ADA |
| | | 03.9436.14ADA |
| | | Mains Dimming |
| | | 03.9436.40ANI |
| | | 03.9436.14ANI |
| | | Casambi |
| | | 03.9436.40ACB |
| | | 03.9436.14ACB |
| | | Non Dimmable |
| | | 05.1565.40A |
| | | 05.1565.14A |
| | | Dali Version |
| | | 05.1565.40ADA |
| | | 05.1565.14ADA |
| | | Mains Dimming |
| | | 05.1565.40ANI |
| | | 05.1565.14ANI |
| | | Casambi |
| | | 05.1565.40ACB |
| | | 05.1565.14ACB |
| | | Non Dimmable |
| | | 05.1566.40A |
| | | 05.1566.14A |
| | | Dali Version |
| | | 05.1566.40ADA |
| | | 05.1566.14ADA |
| | | Mains Dimming |
| | | 05.1566.40ANI |
| | | 05.1566.14ANI |
| | | Casambi |
| | | 05.1566.40ACB |
| | | 05.1566.14ACB |
| | | Non Dimmable |
| | | 05.1567.40A |
| | | 05.1567.14A |
| | | Dali Version |
| | | 05.1567.40ADA |
| | | 05.1567.14ADA |
| | | Mains Dimming |
| | | 05.1567.40ANI |
| | | 05.1567.14ANI |
| | | Casambi |
| | | 05.1567.40ACB |
| | | 05.1567.14ACB |

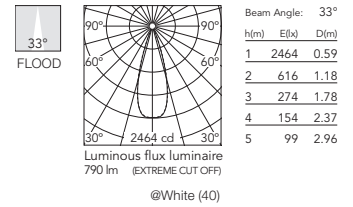

Optic Wide Flood 2700K

- | | |
|-----|---------------|
| E I | Non Dimmable |
| | 03.7358.40A |
| | 03.7358.14A |
| | Dali Version |
| | 03.7358.40ADA |
| | 03.7358.14ADA |
| | Mains Dimming |
| | 03.7358.40ANI |
| | 03.7358.14ANI |
| | Casambi |
| | 03.7358.40ACB |
| | 03.7358.14ACB |
| | Non Dimmable |
| | 03.7359.40A |
| | 03.7359.14A |
| | Dali Version |
| | 03.7359.40ADA |
| | 03.7359.14ADA |
| | Mains Dimming |
| | 03.7359.40ANI |
| | 03.7359.14ANI |
| | Casambi |
| | 03.7359.40ACB |
| | 03.7359.14ACB |
| | Non Dimmable |
| | 05.1570.40A |
| | 05.1570.14A |
| | Dali Version |
| | 05.1570.40ADA |
| | 05.1570.14ADA |
| | Mains Dimming |
| | 05.1570.40ANI |
| | 05.1570.14ANI |
| | Casambi |
| | 05.1570.40ACB |
| | 05.1570.14ACB |
| | Non Dimmable |
| | 05.1571.40A |
| | 05.1571.14A |
| | Dali Version |
| | 05.1571.40ADA |
| | 05.1571.14ADA |
| | Mains Dimming |
| | 05.1571.40ANI |
| | 05.1571.14ANI |
| | Casambi |
| | 05.1571.40ACB |
| | 05.1571.14ACB |
| | Non Dimmable |
| | 05.1572.40A |
| | 05.1572.14A |
| | Dali Version |
| | 05.1572.40ADA |
| | 05.1572.14ADA |
| | Mains Dimming |
| | 05.1572.40ANI |
| | 05.1572.14ANI |
| | Casambi |
| | 05.1572.40ACB |
| | 05.1572.14ACB |

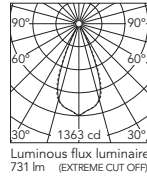

Beam Angle: 45°

	h(m)	E(lx)	D(m)
1	1363	0.83	
2	341	1.67	
3	151	2.50	
4	85	3.34	
5	55	4.17	

@White (40)

Optic Wide Flood 3000K

- | | |
|-----|---------------|
| E I | Non Dimmable |
| | 03.7362.40A |
| | 03.7362.14A |
| | Dali Version |
| | 03.7362.40ADA |
| | 03.7362.14ADA |
| | Mains Dimming |
| | 03.7362.40ANI |
| | 03.7362.14ANI |
| | Casambi |
| | 03.7362.40ACB |
| | 03.7362.14ACB |
| | Non Dimmable |
| | 03.7363.40A |
| | 03.7363.14A |
| | Dali Version |
| | 03.7363.40ADA |
| | 03.7363.14ADA |
| | Mains Dimming |
| | 03.7363.40ANI |
| | 03.7363.14ANI |
| | Casambi |
| | 03.7363.40ACB |
| | 03.7363.14ACB |
| | Non Dimmable |
| | 05.1575.40A |
| | 05.1575.14A |
| | Dali Version |
| | 05.1575.40ADA |
| | 05.1575.14ADA |
| | Mains Dimming |
| | 05.1575.40ANI |
| | 05.1575.14ANI |
| | Casambi |
| | 05.1575.40ACB |
| | 05.1575.14ACB |
| | Non Dimmable |
| | 05.1576.40A |
| | 05.1576.14A |
| | Dali Version |
| | 05.1576.40ADA |
| | 05.1576.14ADA |
| | Mains Dimming |
| | 05.1576.40ANI |
| | 05.1576.14ANI |
| | Casambi |
| | 05.1576.40ACB |
| | 05.1576.14ACB |
| | Non Dimmable |
| | 05.1577.40A |
| | 05.1577.14A |
| | Dali Version |
| | 05.1577.40ADA |
| | 05.1577.14ADA |
| | Mains Dimming |
| | 05.1577.40ANI |
| | 05.1577.14ANI |
| | Casambi |
| | 05.1577.40ACB |
| | 05.1577.14ACB |

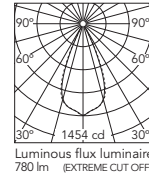

Beam Angle: 45°

	h(m)	E(lx)	D(m)
1	1454	0.83	
2	363	1.67	
3	162	2.50	
4	91	3.34	
5	58	4.17	

@White (40)

LIGHT SHADOW

Light Shadow Adjustable No Trim 8 Spots

Light Source: Power LED DC 900 mA 21,6W - 2160 lm - 2700K/CRI 90 / 21,6W - 2280 lm - 3000K/CRI 90
 Mains dimming: Power LED DC 750 mA 18,5W - 1800 lm - 2700K/CRI 90 / 18,5W - 1900 lm - 3000K/CRI 90

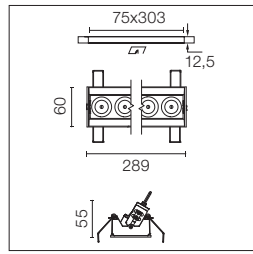

- GWT 850°
- 30°-30°
- 0,50 Kg
- TEGEE
- DALI LED INCL
- h=75 min
- CE
- IP 20

Leuchte für Unterputzmontage mit 8 LED-Lichtquellen. Externes Netzgerät eingeschlossen (220-240V). Vorinstallationsrahmen. Muss separat bestellt werden.

E= Außenfarbe
I= Innenfarbe

Recessed integrated luminaire with 8 LED lighting spots. Remote power supply included (220-240V). It requires a pre-installation frame, to be ordered separately.

E= External Finish
I= Internal Finish

Optic Spot 2700K

- Non Dimmable
- 03.8932.40A
- 03.8932.14A
- Dali Version
- 03.8932.40ADA
- 03.8932.14ADA
- Mains Dimming
- 03.8932.40ANI
- 03.8932.14ANI
- Casambi
- 03.8932.40ACB
- 03.8932.14ACB
- Non Dimmable
- 03.8933.40A
- 03.8933.14A
- Dali Version
- 03.8933.40ADA
- 03.8933.14ADA
- Mains Dimming
- 03.8933.40ANI
- 03.8933.14ANI
- Casambi
- 03.8933.40ACB
- 03.8933.14ACB
- Non Dimmable
- 05.1640.40A
- 05.1640.14A
- Dali Version
- 05.1640.40ADA
- 05.1640.14ADA
- Mains Dimming
- 05.1640.40ANI
- 05.1640.14ANI
- Casambi
- 05.1640.40ACB
- 05.1640.14ACB
- Non Dimmable
- 05.1641.40A
- 05.1641.14A
- Dali Version
- 05.1641.40ADA
- 05.1641.14ADA
- Mains Dimming
- 05.1641.40ANI
- 05.1641.14ANI
- Casambi
- 05.1641.40ACB
- 05.1641.14ACB
- Non Dimmable
- 05.1642.40A
- 05.1642.14A
- Dali Version
- 05.1642.40ADA
- 05.1642.14ADA
- Mains Dimming
- 05.1642.40ANI
- 05.1642.14ANI
- Casambi
- 05.1642.40ACB
- 05.1642.14ACB

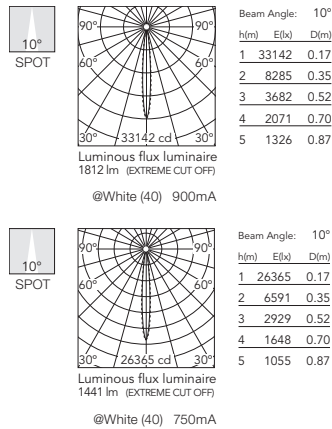





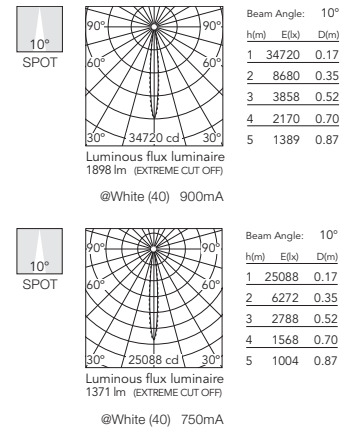















Optic Spot 3000K

- Non Dimmable
- 03.8936.40A
- 03.8936.14A
- Dali Version
- 03.8936.40ADA
- 03.8936.14ADA
- Mains Dimming
- 03.8936.40ANI
- 03.8936.14ANI
- Casambi
- 03.8936.40ACB
- 03.8936.14ACB
- Non Dimmable
- 03.8937.40A
- 03.8937.14A
- Dali Version
- 03.8937.40ADA
- 03.8937.14ADA
- Mains Dimming
- 03.8937.40ANI
- 03.8937.14ANI
- Casambi
- 03.8937.40ACB
- 03.8937.14ACB
- Non Dimmable
- 05.1645.40A
- 05.1645.14A
- Dali Version
- 05.1645.40ADA
- 05.1645.14ADA
- Mains Dimming
- 05.1645.40ANI
- 05.1645.14ANI
- Casambi
- 05.1645.40ACB
- 05.1645.14ACB
- Non Dimmable
- 05.1646.40A
- 05.1646.14A
- Dali Version
- 05.1646.40ADA
- 05.1646.14ADA
- Mains Dimming
- 05.1646.40ANI
- 05.1646.14ANI
- Casambi
- 05.1646.40ACB
- 05.1646.14ACB
- Non Dimmable
- 05.1647.40A
- 05.1647.14A
- Dali Version
- 05.1647.40ADA
- 05.1647.14ADA
- Mains Dimming
- 05.1647.40ANI
- 05.1647.14ANI
- Casambi
- 05.1647.40ACB
- 05.1647.14ACB







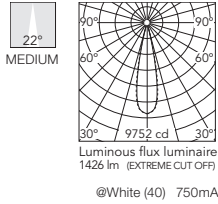
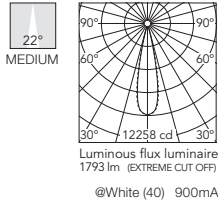















Optic Medium 2700K

-  Non Dimmable
03.9440.40A
03.9440.14A
Dali Version
-  03.9440.40ADA
03.9440.14ADA
Mains Dimming
-  03.9440.40ANI
03.9440.14ANI
Casambi
-  03.9440.40ACB
03.9440.14ACB
Non Dimmable
-  03.9441.40A
03.9441.14A
Dali Version
-  03.9441.40ADA
03.9441.14ADA
Mains Dimming
-  03.9441.40ANI
03.9441.14ANI
Casambi
-  03.9441.40ACB
03.9441.14ACB
Non Dimmable
-  05.1650.40A
05.1650.14A
Dali Version
-  05.1650.40ADA
05.1650.14ADA
Mains Dimming
-  05.1650.40ANI
05.1650.14ANI
Casambi
-  05.1650.40ACB
05.1650.14ACB
Non Dimmable
-  05.1651.40A
05.1651.14A
Dali Version
-  05.1651.40ADA
05.1651.14ADA
Mains Dimming
-  05.1651.40ANI
05.1651.14ANI
Casambi
-  05.1651.40ACB
05.1651.14ACB
Non Dimmable
-  05.1652.40A
05.1652.14A
Dali Version
-  05.1652.40ADA
05.1652.14ADA
Mains Dimming
-  05.1652.40ANI
05.1652.14ANI
Casambi
-  05.1652.40ACB
05.1652.14ACB
Non Dimmable



Optic Medium 3000K

-  Non Dimmable
03.9450.40A
03.9450.14A
Dali Version
-  03.9450.40ADA
03.9450.14ADA
Mains Dimming
-  03.9450.40ANI
03.9450.14ANI
Casambi
-  03.9450.40ACB
03.9450.14ACB
Non Dimmable
-  03.9451.40A
03.9451.14A
Dali Version
-  03.9451.40ADA
03.9451.14ADA
Mains Dimming
-  03.9451.40ANI
03.9451.14ANI
Casambi
-  03.9451.40ACB
03.9451.14ACB
Non Dimmable
-  05.1655.40A
05.1655.14A
Dali Version
-  05.1655.40ADA
05.1655.14ADA
Mains Dimming
-  05.1655.40ANI
05.1655.14ANI
Casambi
-  05.1655.40ACB
05.1655.14ACB
Non Dimmable
-  05.1656.40A
05.1656.14A
Dali Version
-  05.1656.40ADA
05.1656.14ADA
Mains Dimming
-  05.1656.40ANI
05.1656.14ANI
Casambi
-  05.1656.40ACB
05.1656.14ACB
Non Dimmable
-  05.1657.40A
05.1657.14A
Dali Version
-  05.1657.40ADA
05.1657.14ADA
Mains Dimming
-  05.1657.40ANI
05.1657.14ANI
Casambi
-  05.1657.40ACB
05.1657.14ACB
Non Dimmable

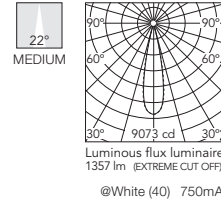
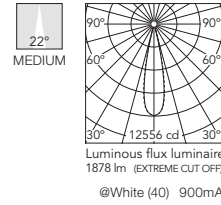

Light Shadow Adjustable No Trim 8 Spots

Light Source: Power LED DC 900 mA 21,6W - 2160 lm - 2700K/CRI 90 / 21,6W - 2280 lm - 3000K/CRI 90
 Mains dimming: Power LED DC 750 mA 18,5W - 1800 lm - 2700K/CRI 90 / 18,5W - 1900 lm - 3000K/CRI 90

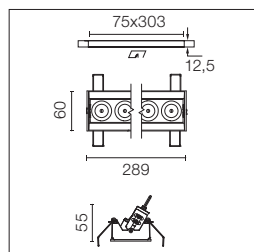

Leuchte für Unterputzmontage mit 8 LED-Lichtquellen. Externes Netzgerät eingeschlossen (220-240V). Vorinstallationsrahmen. Muss separat bestellt werden.

E= Außenfarbe
I= Innenfarbe

Recessed integrated luminaire with 8 LED lighting spots. Remote power supply included (220-240V). It requires a pre-installation frame, to be ordered separately.

E= External Finish
I= Internal Finish

Optic Flood 2700K

E	I	Non Dimmable
□	□	03.9445.40A
□	□	03.9445.14A
□	□	Dali Version
□	□	03.9445.40ADA
□	□	03.9445.14ADA
□	□	Mains Dimming
□	□	03.9445.40ANI
□	□	03.9445.14ANI
□	□	Casambi
□	□	03.9445.40ACB
□	□	03.9445.14ACB
□	□	Non Dimmable
□	□	03.9446.40A
□	□	03.9446.14A
□	□	Dali Version
□	□	03.9446.40ADA
□	□	03.9446.14ADA
□	□	Mains Dimming
□	□	03.9446.40ANI
□	□	03.9446.14ANI
□	□	Casambi
□	□	03.9446.40ACB
□	□	03.9446.14ACB
□	□	Non Dimmable
□	□	05.1660.40A
□	□	05.1660.14A
□	□	Dali Version
□	□	05.1660.40ADA
□	□	05.1660.14ADA
□	□	Mains Dimming
□	□	05.1660.40ANI
□	□	05.1660.14ANI
□	□	Casambi
□	□	05.1660.40ACB
□	□	05.1660.14ACB
□	□	Non Dimmable
□	□	05.1661.40A
□	□	05.1661.14A
□	□	Dali Version
□	□	05.1661.40ADA
□	□	05.1661.14ADA
□	□	Mains Dimming
□	□	05.1661.40ANI
□	□	05.1661.14ANI
□	□	Casambi
□	□	05.1661.40ACB
□	□	05.1661.14ACB
□	□	Non Dimmable
□	□	05.1662.40A
□	□	05.1662.14A
□	□	Dali Version
□	□	05.1662.40ADA
□	□	05.1662.14ADA
□	□	Mains Dimming
□	□	05.1662.40ANI
□	□	05.1662.14ANI
□	□	Casambi
□	□	05.1662.40ACB
□	□	05.1662.14ACB

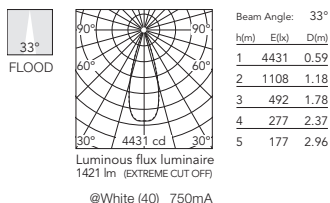
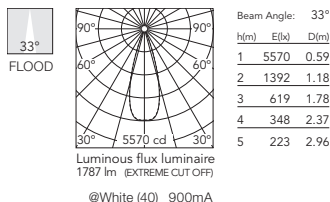





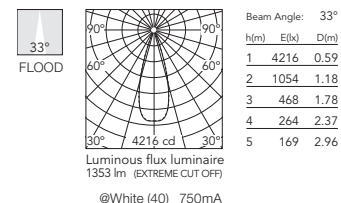
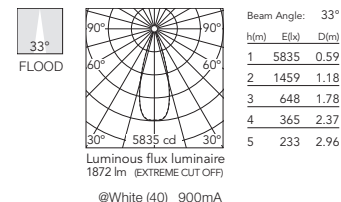















Optic Flood 3000K

E	I	Non Dimmable
□	□	03.9455.40A
□	□	03.9455.14A
□	□	Dali Version
□	□	03.9455.40ADA
□	□	03.9455.14ADA
□	□	Mains Dimming
□	□	03.9455.40ANI
□	□	03.9455.14ANI
□	□	Casambi
□	□	03.9455.40ACB
□	□	03.9455.14ACB
□	□	Non Dimmable
□	□	03.9456.40A
□	□	03.9456.14A
□	□	Dali Version
□	□	03.9456.40ADA
□	□	03.9456.14ADA
□	□	Mains Dimming
□	□	03.9456.40ANI
□	□	03.9456.14ANI
□	□	Casambi
□	□	03.9456.40ACB
□	□	03.9456.14ACB
□	□	Non Dimmable
□	□	05.1665.40A
□	□	05.1665.14A
□	□	Dali Version
□	□	05.1665.40ADA
□	□	05.1665.14ADA
□	□	Mains Dimming
□	□	05.1665.40ANI
□	□	05.1665.14ANI
□	□	Casambi
□	□	05.1665.40ACB
□	□	05.1665.14ACB
□	□	Non Dimmable
□	□	05.1666.40A
□	□	05.1666.14A
□	□	Dali Version
□	□	05.1666.40ADA
□	□	05.1666.14ADA
□	□	Mains Dimming
□	□	05.1666.40ANI
□	□	05.1666.14ANI
□	□	Casambi
□	□	05.1666.40ACB
□	□	05.1666.14ACB
□	□	Non Dimmable
□	□	05.1667.40A
□	□	05.1667.14A
□	□	Dali Version
□	□	05.1667.40ADA
□	□	05.1667.14ADA
□	□	Mains Dimming
□	□	05.1667.40ANI
□	□	05.1667.14ANI
□	□	Casambi
□	□	05.1667.40ACB
□	□	05.1667.14ACB







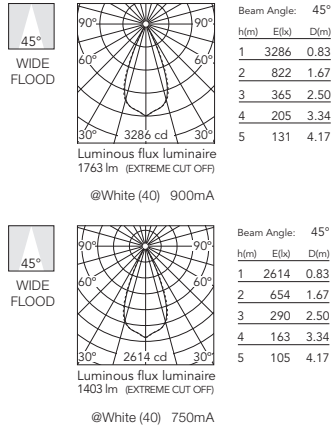















Optic Wide Flood 2700K

-  Non Dimmable
03.7366.40A
03.7366.14A
Dali Version
-  03.7366.40ADA
03.7366.14ADA
Mains Dimming
-  03.7366.40ANI
03.7366.14ANI
Casambi
-  03.7366.40ACB
03.7366.14ACB
Non Dimmable
-  03.7367.40A
03.7367.14A
Dali Version
-  03.7367.40ADA
03.7367.14ADA
Mains Dimming
-  03.7367.40ANI
03.7367.14ANI
Casambi
-  03.7367.40ACB
03.7367.14ACB
Non Dimmable
-  05.1670.40A
05.1670.14A
Dali Version
-  05.1670.40ADA
05.1670.14ADA
Mains Dimming
-  05.1670.40ANI
05.1670.14ANI
Casambi
-  05.1670.40ACB
05.1670.14ACB
Non Dimmable
-  05.1671.40A
05.1671.14A
Dali Version
-  05.1671.40ADA
05.1671.14ADA
Mains Dimming
-  05.1671.40ANI
05.1671.14ANI
Casambi
-  05.1671.40ACB
05.1671.14ACB
Non Dimmable
-  05.1672.40A
05.1672.14A
Dali Version
-  05.1672.40ADA
05.1672.14ADA
Mains Dimming
-  05.1672.40ANI
05.1672.14ANI
Casambi
-  05.1672.40ACB
05.1672.14ACB



Optic Wide Flood 3000K

-  Non Dimmable
03.7370.40A
03.7370.14A
Dali Version
-  03.7370.40ADA
03.7370.14ADA
Mains Dimming
-  03.7370.40ANI
03.7370.14ANI
Casambi
-  03.7370.40ACB
03.7370.14ACB
Non Dimmable
-  03.7371.40A
03.7371.14A
Dali Version
-  03.7371.40ADA
03.7371.14ADA
Mains Dimming
-  03.7371.40ANI
03.7371.14ANI
Casambi
-  03.7371.40ACB
03.7371.14ACB
Non Dimmable
-  05.1675.40A
05.1675.14A
Dali Version
-  05.1675.40ADA
05.1675.14ADA
Mains Dimming
-  05.1675.40ANI
05.1675.14ANI
Casambi
-  05.1675.40ACB
05.1675.14ACB
Non Dimmable
-  05.1676.40A
05.1676.14A
Dali Version
-  05.1676.40ADA
05.1676.14ADA
Mains Dimming
-  05.1676.40ANI
05.1676.14ANI
Casambi
-  05.1676.40ACB
05.1676.14ACB
Non Dimmable
-  05.1677.40A
05.1677.14A
Dali Version
-  05.1677.40ADA
05.1677.14ADA
Mains Dimming
-  05.1677.40ANI
05.1677.14ANI
Casambi
-  05.1677.40ACB
05.1677.14ACB

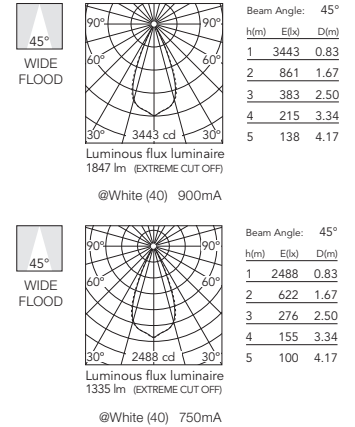

LIGHT SHADOW

Light Shadow Adjustable No Trim 12 Spots

Light Source: Power LED DC 900 mA 32,4W - 3240 lm - 2700K/CRI 90 / 32,4W - 3420 lm - 3000K/CRI 90
 Mains dimming: Power LED DC 750 mA 28W - 2710 lm - 2700K/CRI 90 / 28W - 2860 lm - 3000K/CRI 90

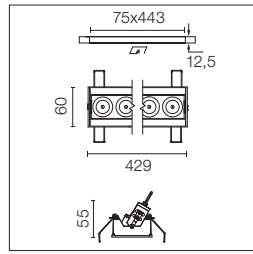

- GWT 850°
- 30°-30°
- 0,66 Kg
- TEGEE
- DALI
- LED INCL
- h=75 min
- CE
- IP 20

Leuchte für Unterputzmontage mit 12 LED-Lichtquellen. Externes Netzgerät eingeschlossen (220-240V). Vorinstallationsrahmen. Muss separat bestellt werden.

E= Außenfarbe
I= Innenfarbe

Recessed integrated luminaire with 12 LED lighting spots. Remote power supply included (220-240V). It requires a pre-installation frame, to be ordered separately.

E= External Finish
I= Internal Finish

Optic Spot 2700K

- Non Dimmable
- 03.8940.40A
- 03.8940.14A
- Dali & Push Version
- 03.8940.40ADA
- 03.8940.14ADA
- Mains Dimming
- 03.8940.40ANI
- 03.8940.14ANI
- Casambi
- 03.8940.40ACB
- 03.8940.14ACB
- Non Dimmable
- 03.8941.40A
- 03.8941.14A
- Dali & Push Version
- 03.8941.40ADA
- 03.8941.14ADA
- Mains Dimming
- 03.8941.40ANI
- 03.8941.14ANI
- Casambi
- 03.8941.40ACB
- 03.8941.14ACB
- Non Dimmable
- 05.1740.40A
- 05.1740.14A
- Dali & Push Version
- 05.1740.40ADA
- 05.1740.14ADA
- Mains Dimming
- 05.1740.40ANI
- 05.1740.14ANI
- Casambi
- 05.1740.40ACB
- 05.1740.14ACB
- Non Dimmable
- 05.1741.40A
- 05.1741.14A
- Dali & Push Version
- 05.1741.40ADA
- 05.1741.14ADA
- Mains Dimming
- 05.1741.40ANI
- 05.1741.14ANI
- Casambi
- 05.1741.40ACB
- 05.1741.14ACB
- Non Dimmable
- 05.1742.40A
- 05.1742.14A
- Dali & Push Version
- 05.1742.40ADA
- 05.1742.14ADA
- Mains Dimming
- 05.1742.40ANI
- 05.1742.14ANI
- Casambi
- 05.1742.40ACB
- 05.1742.14ACB

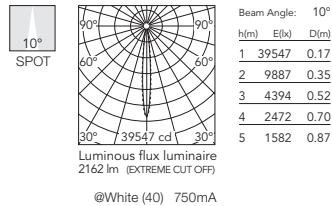
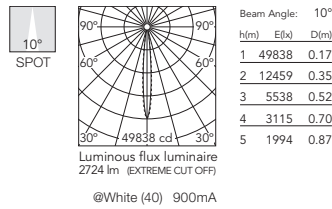





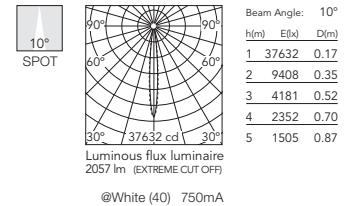
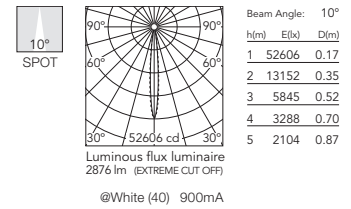















Optic Spot 3000K

- Non Dimmable
- 03.8944.40A
- 03.8944.14A
- Dali & Push Version
- 03.8944.40ADA
- 03.8944.14ADA
- Mains Dimming
- 03.8944.40ANI
- 03.8944.14ANI
- Casambi
- 03.8944.40ACB
- 03.8944.14ACB
- Non Dimmable
- 03.8945.40A
- 03.8945.14A
- Dali & Push Version
- 03.8945.40ADA
- 03.8945.14ADA
- Mains Dimming
- 03.8945.40ANI
- 03.8945.14ANI
- Casambi
- 03.8945.40ACB
- 03.8945.14ACB
- Non Dimmable
- 05.1745.40A
- 05.1745.14A
- Dali & Push Version
- 05.1745.40ADA
- 05.1745.14ADA
- Mains Dimming
- 05.1745.40ANI
- 05.1745.14ANI
- Casambi
- 05.1745.40ACB
- 05.1745.14ACB
- Non Dimmable
- 05.1746.40A
- 05.1746.14A
- Dali & Push Version
- 05.1746.40ADA
- 05.1746.14ADA
- Mains Dimming
- 05.1746.40ANI
- 05.1746.14ANI
- Casambi
- 05.1746.40ACB
- 05.1746.14ACB
- Non Dimmable
- 05.1747.40A
- 05.1747.14A
- Dali & Push Version
- 05.1747.40ADA
- 05.1747.14ADA
- Mains Dimming
- 05.1747.40ANI
- 05.1747.14ANI
- Casambi
- 05.1747.40ACB
- 05.1747.14ACB







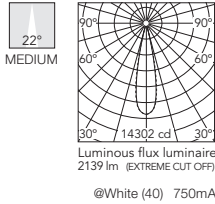
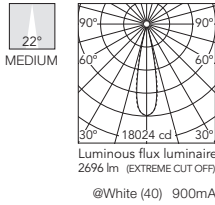















**Optic Medium
2700K**

-  Non Dimmable
03.9460.40A
03.9460.14A
Dali & Push Version
-  03.9460.40ADA
03.9460.14ADA
Mains Dimming
-  03.9460.40ANI
03.9460.14ANI
Casambi
-  03.9460.40ACB
03.9460.14ACB
Non Dimmable
-  03.9461.40A
03.9461.14A
Dali & Push Version
-  03.9461.40ADA
03.9461.14ADA
Mains Dimming
-  03.9461.40ANI
03.9461.14ANI
Casambi
-  03.9461.40ACB
03.9461.14ACB
Non Dimmable
-  05.1750.40A
05.1750.14A
Dali & Push Version
-  05.1750.40ADA
05.1750.14ADA
Mains Dimming
-  05.1750.40ANI
05.1750.14ANI
Casambi
-  05.1750.40ACB
05.1750.14ACB
Non Dimmable
-  05.1751.40A
05.1751.14A
Dali & Push Version
-  05.1751.40ADA
05.1751.14ADA
Mains Dimming
-  05.1751.40ANI
05.1751.14ANI
Casambi
-  05.1751.40ACB
05.1751.14ACB
Non Dimmable
-  05.1752.40A
05.1752.14A
Dali & Push Version
-  05.1752.40ADA
05.1752.14ADA
Mains Dimming
-  05.1752.40ANI
05.1752.14ANI
Casambi
-  05.1752.40ACB
05.1752.14ACB



**Optic Medium
3000K**

-  Non Dimmable
03.9470.40A
03.9470.14A
Dali & Push Version
-  03.9470.40ADA
03.9470.14ADA
Mains Dimming
-  03.9470.40ANI
03.9470.14ANI
Casambi
-  03.9470.40ACB
03.9470.14ACB
Non Dimmable
-  03.9471.40A
03.9471.14A
Dali & Push Version
-  03.9471.40ADA
03.9471.14ADA
Mains Dimming
-  03.9471.40ANI
03.9471.14ANI
Casambi
-  03.9471.40ACB
03.9471.14ACB
Non Dimmable
-  05.1755.40A
05.1755.14A
Dali & Push Version
-  05.1755.40ADA
05.1755.14ADA
Mains Dimming
-  05.1755.40ANI
05.1755.14ANI
Casambi
-  05.1755.40ACB
05.1755.14ACB
Non Dimmable
-  05.1756.40A
05.1756.14A
Dali & Push Version
-  05.1756.40ADA
05.1756.14ADA
Mains Dimming
-  05.1756.40ANI
05.1756.14ANI
Casambi
-  05.1756.40ACB
05.1756.14ACB
Non Dimmable
-  05.1757.40A
05.1757.14A
Dali & Push Version
-  05.1757.40ADA
05.1757.14ADA
Mains Dimming
-  05.1757.40ANI
05.1757.14ANI
Casambi
-  05.1757.40ACB
05.1757.14ACB

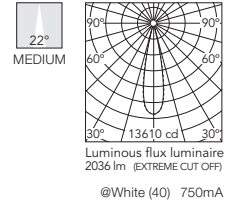
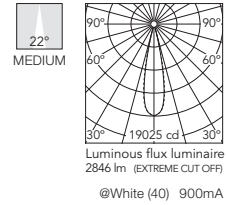

LIGHT SHADOW

Light Shadow Adjustable No Trim 12 Spots

Light Source: Power LED DC 900 mA 32,4W - 3240 lm - 2700K/CRI 90 / 32,4W - 3420 lm - 3000K/CRI 90
 Mains dimming: Power LED DC 750 mA 28W - 2710 lm - 2700K/CRI 90 / 28W - 2860 lm - 3000K/CRI 90

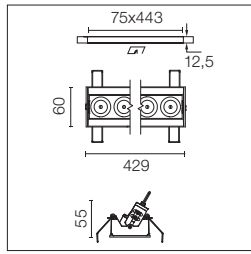

Leuchte für Unterputzmontage mit 12 LED-Lichtquellen. Externes Netzgerät eingeschlossen (220-240V). Vorinstallationsrahmen. Muss separat bestellt werden.

Recessed integrated luminaire with 12 LED lighting spots. Remote power supply included (220-240V). It requires a pre-installation frame, to be ordered separately.

E= Außenfarbe
I= Innenfarbe

E= External Finish
I= Internal Finish

Optic Flood 2700K

- E I Non Dimmable
- 03.9465.40A
- 03.9465.14A
- Dali & Push Version
- 03.9465.40ADA
- 03.9465.14ADA
- Mains Dimming
- 03.9465.40ANI
- 03.9465.14ANI
- Casambi
- 03.9465.40ACB
- 03.9465.14ACB
- Non Dimmable
- 03.9466.40A
- 03.9466.14A
- Dali & Push Version
- 03.9466.40ADA
- 03.9466.14ADA
- Mains Dimming
- 03.9466.40ANI
- 03.9466.14ANI
- Casambi
- 03.9466.40ACB
- 03.9466.14ACB
- Non Dimmable
- 05.1760.40A
- 05.1760.14A
- Dali & Push Version
- 05.1760.40ADA
- 05.1760.14ADA
- Mains Dimming
- 05.1760.40ANI
- 05.1760.14ANI
- Casambi
- 05.1760.40ACB
- 05.1760.14ACB
- Non Dimmable
- 05.1761.40A
- 05.1761.14A
- Dali & Push Version
- 05.1761.40ADA
- 05.1761.14ADA
- Mains Dimming
- 05.1761.40ANI
- 05.1761.14ANI
- Casambi
- 05.1761.40ACB
- 05.1761.14ACB
- Non Dimmable
- 05.1762.40A
- 05.1762.14A
- Dali & Push Version
- 05.1762.40ADA
- 05.1762.14ADA
- Mains Dimming
- 05.1762.40ANI
- 05.1762.14ANI
- Casambi
- 05.1762.40ACB
- 05.1762.14ACB

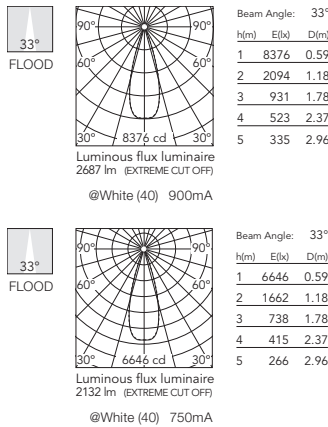





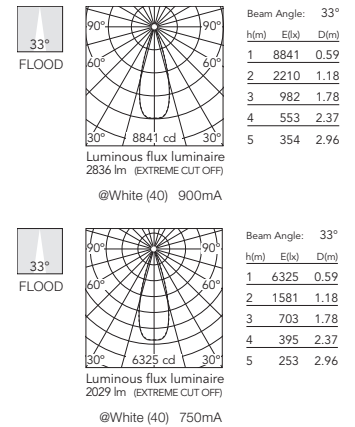























































Optic Flood 3000K

- E I Non Dimmable
- 03.9475.40A
- 03.9475.14A
- Dali & Push Version
- 03.9475.40ADA
- 03.9475.14ADA
- Mains Dimming
- 03.9475.40ANI
- 03.9475.14ANI
- Casambi
- 03.9475.40ACB
- 03.9475.14ACB
- Non Dimmable
- 03.9476.40A
- 03.9476.14A
- Dali & Push Version
- 03.9476.40ADA
- 03.9476.14ADA
- Mains Dimming
- 03.9476.40ANI
- 03.9476.14ANI
- Casambi
- 03.9476.40ACB
- 03.9476.14ACB
- Non Dimmable
- 05.1765.40A
- 05.1765.14A
- Dali & Push Version
- 05.1765.40ADA
- 05.1765.14ADA
- Mains Dimming
- 05.1765.40ANI
- 05.1765.14ANI
- Casambi
- 05.1765.40ACB
- 05.1765.14ACB
- Non Dimmable
- 05.1766.40A
- 05.1766.14A
- Dali & Push Version
- 05.1766.40ADA
- 05.1766.14ADA
- Mains Dimming
- 05.1766.40ANI
- 05.1766.14ANI
- Casambi
- 05.1766.40ACB
- 05.1766.14ACB
- Non Dimmable
- 05.1767.40A
- 05.1767.14A
- Dali & Push Version
- 05.1767.40ADA
- 05.1767.14ADA
- Mains Dimming
- 05.1767.40ANI
- 05.1767.14ANI
- Casambi
- 05.1767.40ACB
- 05.1767.14ACB







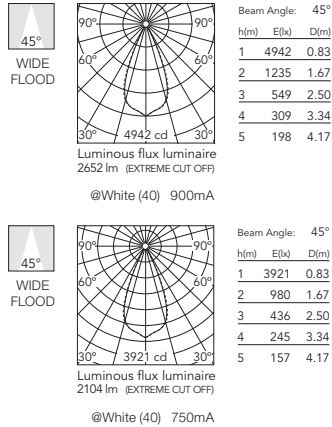























































Optic Wide Flood 2700K

-  Non Dimmable
-  03.7374.40A
-  03.7374.14A
-  Dali & Push Version
-  03.7374.40ADA
-  03.7374.14ADA
-  Mains Dimming
-  03.7374.40ANI
-  03.7374.14ANI
-  Casambi
-  03.7374.40ACB
-  03.7374.14ACB
-  Non Dimmable
-  03.7375.40A
-  03.7375.14A
-  Dali & Push Version
-  03.7375.40ADA
-  03.7375.14ADA
-  Mains Dimming
-  03.7375.40ANI
-  03.7375.14ANI
-  Casambi
-  03.7375.40ACB
-  03.7375.14ACB
-  Non Dimmable
-  05.1770.40A
-  05.1770.14A
-  Dali & Push Version
-  05.1770.40ADA
-  05.1770.14ADA
-  Mains Dimming
-  05.1770.40ANI
-  05.1770.14ANI
-  Casambi
-  05.1770.40ACB
-  05.1770.14ACB
-  Non Dimmable
-  05.1771.40A
-  05.1771.14A
-  Dali & Push Version
-  05.1771.40ADA
-  05.1771.14ADA
-  Mains Dimming
-  05.1771.40ANI
-  05.1771.14ANI
-  Casambi
-  05.1771.40ACB
-  05.1771.14ACB
-  Non Dimmable
-  05.1772.40A
-  05.1772.14A
-  Dali & Push Version
-  05.1772.40ADA
-  05.1772.14ADA
-  Mains Dimming
-  05.1772.40ANI
-  05.1772.14ANI
-  Casambi
-  05.1772.40ACB
-  05.1772.14ACB



Optic Wide Flood 3000K

-  Non Dimmable
-  03.7378.40A
-  03.7378.14A
-  Dali & Push Version
-  03.7378.40ADA
-  03.7378.14ADA
-  Mains Dimming
-  03.7378.40ANI
-  03.7378.14ANI
-  Casambi
-  03.7378.40ACB
-  03.7378.14ACB
-  Non Dimmable
-  03.7379.40A
-  03.7379.14A
-  Dali & Push Version
-  03.7379.40ADA
-  03.7379.14ADA
-  Mains Dimming
-  03.7379.40ANI
-  03.7379.14ANI
-  Casambi
-  03.7379.40ACB
-  03.7379.14ACB
-  Non Dimmable
-  05.1775.40A
-  05.1775.14A
-  Dali & Push Version
-  05.1775.40ADA
-  05.1775.14ADA
-  Mains Dimming
-  05.1775.40ANI
-  05.1775.14ANI
-  Casambi
-  05.1775.40ACB
-  05.1775.14ACB
-  Non Dimmable
-  05.1776.40A
-  05.1776.14A
-  Dali & Push Version
-  05.1776.40ADA
-  05.1776.14ADA
-  Mains Dimming
-  05.1776.40ANI
-  05.1776.14ANI
-  Casambi
-  05.1776.40ACB
-  05.1776.14ACB
-  Non Dimmable
-  05.1777.40A
-  05.1777.14A
-  Dali & Push Version
-  05.1777.40ADA
-  05.1777.14ADA
-  Mains Dimming
-  05.1777.40ANI
-  05.1777.14ANI
-  Casambi
-  05.1777.40ACB
-  05.1777.14ACB

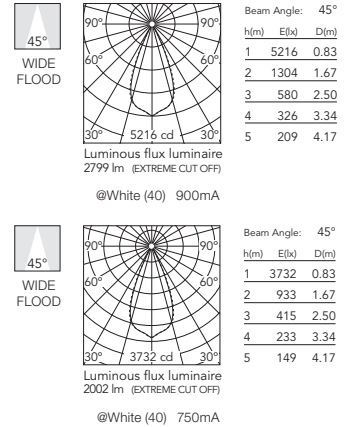

LIGHT SHADOW WALL-WASHER

Light Shadow Wall-Washer Trim 4 Spots

Light Source: Power LED 1 DC 900 mA 0,8W - 1080 lm - 2700K/CRI 90 / 10,8W - 1140lm - 3000K/CRI 90

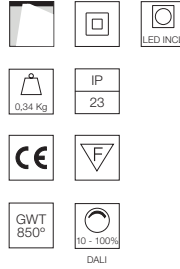
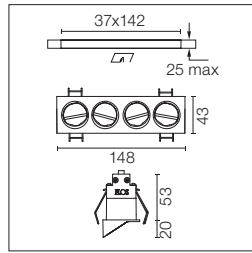

Einbauleuchte mit 4 LED-Strahlern.
Fernbedienung inklusive (220-240V).
Vorinstallationsrahmen nicht erforderlich.

Recessed integrated luminaire with
4 LED lighting spots. Remote power
supply included (220-240V).
Pre-installation frame not required.

2700K

- 03.9901.40A
- 03.9901.14A
- Dali Version
- 03.9901.40ADA
- 03.9901.14ADA
- Mains Dimming
- 03.9901.40ANI
- 03.9901.14ANI
- Casambi
- 03.9901.40ACB
- 03.9901.14ACB

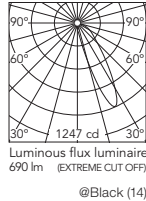

Beam Angle: 22°

h(m)	E(lx)	D(m)
1	1247	0.50
2	312	0.99
3	139	1.49
4	78	1.99
5	50	2.48

3000K

- 03.9900.40A
- 03.9900.14A
- Dali Version
- 03.9900.40ADA
- 03.9900.14ADA
- Mains Dimming
- 03.9900.40ANI
- 03.9900.14ANI
- Casambi
- 03.9900.40ACB
- 03.9900.14ACB

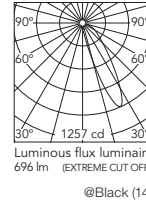

Beam Angle: 22°

h(m)	E(lx)	D(m)
1	1257	0.50
2	314	0.99
3	140	1.49
4	79	1.99
5	50	2.48

Light Shadow Wall-Washer No Trim 4 Spots

Light Source: Power LED DC 900 mA 10,8W - 1080 lm - 2700K/CRI 90 / 10,8W - 1140lm - 3000K/CRI 90

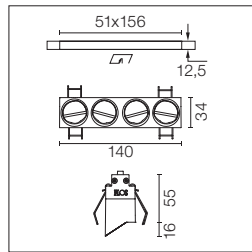

Einbauleuchte mit 4 LED-Strahlern.
Fernbedienung inklusive (220-240V).
Vorinstallationsrahmen erforderlich,
separat zu bestellen (08.0511.00).

Recessed integrated luminaire with
4 LED lighting spots. Remote power
supply included (220-240V).
It requires a pre-installation frame,
to be ordered separately
(08.0511.00).

2700K

- 03.9903.40A
- 03.9903.14A
- Dali Version
- 03.9903.40ADA
- 03.9903.14ADA
- Mains Dimming
- 03.9903.40ANI
- 03.9903.14ANI
- Casambi
- 03.9903.40ACB
- 03.9903.14ACB

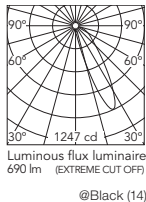

Beam Angle: 22°

h(m)	E(lx)	D(m)
1	1247	0.50
2	312	0.99
3	139	1.49
4	78	1.99
5	50	2.48

3000K

- 03.9902.40A
- 03.9902.14A
- Dali Version
- 03.9902.40ADA
- 03.9902.14ADA
- Mains Dimming
- 03.9902.40ANI
- 03.9902.14ANI
- Casambi
- 03.9902.40ACB
- 03.9902.14ACB

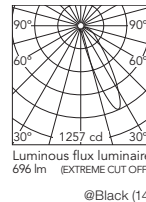

Beam Angle: 22°

h(m)	E(lx)	D(m)
1	1257	0.50
2	314	0.99
3	140	1.49
4	79	1.99
5	50	2.48

LIGHT SHADOW

Zubehör / Accessories

Light Shadow Fixed No Trim

Montagerahmen.	Pre-installation frame.			2L 08.0510.00
Montagerahmen.	Pre-installation frame.			4L 08.0511.00
Montagerahmen.	Pre-installation frame.			8L 08.0512.00
Montagerahmen.	Pre-installation frame.			12L 08.0513.00

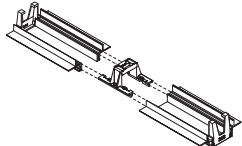

Zubehör für die Montage in fortlaufender Reihe No Trim. Jedes Zubehörteil ermöglicht den Anschluss von zwei No-Trim-Rahmen für die Vorinstallation.	Accessory for mounting of No Trim continuous line. Each accessory allows connection between two No Trim pre-installation frames.			08.0052.90
---	--	---	--	------------

Light Shadow Adjustable No Trim

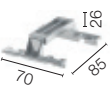
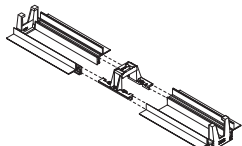
Montagerahmen.	Pre-installation frame.			2L 08.0515.00
Montagerahmen.	Pre-installation frame.			4L 08.0516.00
Montagerahmen.	Pre-installation frame.			8L 08.0517.00
Montagerahmen.	Pre-installation frame.			12L 08.0518.00

Zubehör für die Montage in fortlaufender Reihe No Trim. Jedes Zubehörteil ermöglicht die Verbindung zwischen zwei linearen No Trim-Voreinbaurahmen.	Accessory for mounting of No Trim continuous line. Each accessory allows connection between two No Trim pre-installation linear frames.			08.0059.90
---	---	---	--	------------

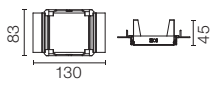
Light Shadow Fixed No Trim Square

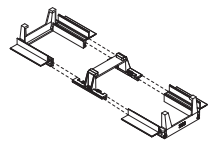
Montagerahmen. Jedes Zubehörteil ermöglicht die Verbindung zwischen zwei eckigen No Trim-Voreinbaurahmen.	Pre-installation frame. Each accessory allows connection between two No Trim pre-installation square frames.			4L 08.0269.00
Zubehör für die Montage in fortlaufender Reihe No Trim. Jedes Zubehörteil ermöglicht den Anschluss von zwei No-Trim-Rahmen für die Vorinstallation.	Accessory for mounting of No Trim continuous line. Each accessory allows connection between two No Trim pre-installation frames.			4L 08.0270.00

LIGHT SHADOW

Light Shadow Surface 4 Spots

Light Source: Power LED DC 900 mA 10,8W - 1080 lm - 2700K/CRI 90 / 10,8W - 1140lm - 3000K/CRI 90

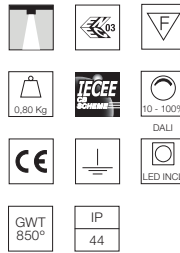
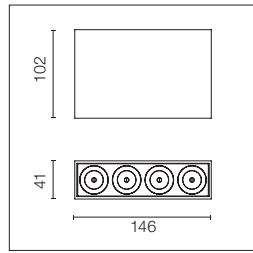

Aufsatzleuchte mit 4 LED-Leuchten. Netzteil 220-240V in der Leuchte integriert.

Surface luminaire with 4 LED lighting spots. Power source 220-240V incorporated.

E= Außenfarbe
I= Innenfarbe
B= Box-Ausführung

E= External Finish
I= Internal Finish
B= Box Finish

Optic Spot 2700K

B	E	I	Product Code
Non Dimmable			03.8956.40A
03.8956.14A			
03.8957.40A			
03.8957.14A			
05.2102.40A			
05.2103.40A			
Dali Version			03.8956.40ADA
03.8956.14ADA			
03.8957.40ADA			
03.8957.14ADA			
05.2102.40ADA			
05.2103.40ADA			
Casambi			03.8956.40ACB
03.8956.14ACB			
03.8957.40ACB			
03.8957.14ACB			
05.2102.40ACB			
05.2103.40ACB			

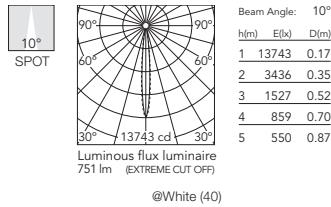

Optic Spot 3000K

B	E	I	Product Code
Non Dimmable			03.8960.40A
03.8960.14A			
03.8961.40A			
03.8961.14A			
05.2107.40A			
05.2108.40A			
Dali Version			03.8960.40ADA
03.8960.14ADA			
03.8961.40ADA			
03.8961.14ADA			
05.2107.40ADA			
05.2108.40ADA			
Casambi			03.8960.40ACB
03.8960.14ACB			
03.8961.40ACB			
03.8961.14ACB			
05.2107.40ACB			
05.2108.40ACB			

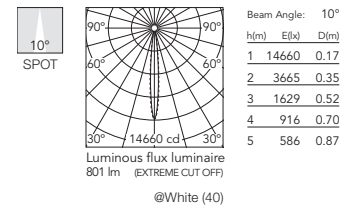

B	E	I	Product Code
Non Dimmable			03.8965.14A
03.8965.40A			
03.8964.14A			
03.8964.40A			
05.2142.14A			
05.2143.14A			
Dali Version			03.8965.14ADA
03.8965.40ADA			
03.8964.14ADA			
03.8964.40ADA			
05.2142.14ADA			
05.2143.14ADA			
Casambi			03.8965.14ACB
03.8965.40ACB			
03.8964.14ACB			
03.8964.40ACB			
05.2142.14ACB			
05.2143.14ACB			

B	E	I	Product Code
Non Dimmable			03.8969.14A
03.8969.40A			
03.8968.14A			
03.8968.40A			
05.2147.14A			
05.2148.14A			
Dali Version			03.8969.14ADA
03.8969.40ADA			
03.8968.14ADA			
03.8968.40ADA			
05.2147.14ADA			
05.2148.14ADA			
Casambi			03.8969.14ACB
03.8969.40ACB			
03.8968.14ACB			
03.8968.40ACB			
05.2147.14ACB			
05.2148.14ACB			

B	E	I	Product Code
Non Dimmable			05.2300.14A
05.2301.14A			
Dali Version			05.2300.14ADA
05.2301.14ADA			
Casambi			05.2300.14ACB
05.2301.14ACB			

B	E	I	Product Code
Non Dimmable			05.2200.14A
05.2201.14A			
Dali Version			05.2200.14ADA
05.2201.14ADA			
Casambi			05.2200.14ACB
05.2201.14ACB			

B	E	I	Product Code
Non Dimmable			05.2305.14A
05.2306.14A			
Dali Version			05.2305.14ADA
05.2306.14ADA			
Casambi			05.2305.14ACB
05.2306.14ACB			

B	E	I	Product Code
Non Dimmable			05.2205.14A
05.2206.14A			
Dali Version			05.2205.14ADA
05.2206.14ADA			
Casambi			05.2205.14ACB
05.2206.14ACB			

B	E	I	Product Code
Non Dimmable			05.2340.14A
05.2341.14A			
Dali Version			05.2340.14ADA
05.2341.14ADA			
Casambi			05.2340.14ACB
05.2341.14ACB			

B	E	I	Product Code
Non Dimmable			05.2240.14A
05.2241.14A			
Dali Version			05.2240.14ADA
05.2241.14ADA			
Casambi			05.2240.14ACB
05.2241.14ACB			

B	E	I	Product Code
Non Dimmable			05.2345.14A
05.2346.14A			
Dali Version			05.2345.14ADA
05.2346.14ADA			
Casambi			05.2345.14ACB
05.2346.14ACB			

B	E	I	Product Code
Non Dimmable			05.2245.14A
05.2246.14A			
Dali Version			05.2245.14ADA
05.2246.14ADA			
Casambi			05.2245.14ACB
05.2246.14ACB			

Optic Medium 2700K



Non Dimmable
 03.9720.40A
 03.9720.14A
 03.9721.40A
 03.9721.14A
 05.2112.40A
 05.2113.40A



Dali Version
 03.9720.40ADA
 03.9720.14ADA
 03.9721.40ADA
 03.9721.14ADA
 05.2112.40ADA
 05.2113.40ADA



Casambi
 03.9720.40ACB
 03.9720.14ACB
 03.9721.40ACB
 03.9721.14ACB
 05.2112.40ACB
 05.2113.40ACB

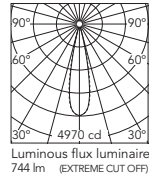

Beam Angle: 22°

h(m)	E(lx)	D(m)
1	4970	0.39
2	1243	0.78
3	552	1.17
4	311	1.56
5	199	1.95

@White (40)

Optic Medium 3000K

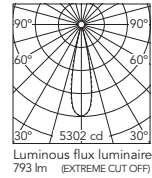

Beam Angle: 22°

h(m)	E(lx)	D(m)
1	5302	0.39
2	1325	0.78
3	589	1.17
4	331	1.56
5	212	1.95

@White (40)



Non Dimmable
 03.9730.40A
 03.9730.14A
 03.9731.40A
 03.9731.14A
 05.2117.40A
 05.2118.40A



Dali Version
 03.9730.40ADA
 03.9730.14ADA
 03.9731.40ADA
 03.9731.14ADA
 05.2117.40ADA
 05.2118.40ADA



Casambi
 03.9730.40ACB
 03.9730.14ACB
 03.9731.40ACB
 03.9731.14ACB
 05.2117.40ACB
 05.2118.40ACB



Non Dimmable
 03.9821.14A
 03.9821.40A
 03.9820.14A
 03.9820.40A
 05.2152.14A
 05.2153.14A



Dali Version
 03.9821.14ADA
 03.9821.40ADA
 03.9820.14ADA
 03.9820.40ADA
 03.2152.40ADA
 05.2153.14ADA



Casambi
 03.9821.14ACB
 03.9821.40ACB
 03.9820.14ACB
 03.9820.40ACB
 03.2152.40ACB
 05.2153.14ACB



Non Dimmable
 03.9831.14A
 03.9831.40A
 03.9830.14A
 03.9830.40A
 05.2157.14A
 05.2158.14A



Dali Version
 03.9831.14ADA
 03.9831.40ADA
 03.9830.14ADA
 03.9830.40ADA
 05.2157.14ADA
 05.2158.14ADA



Casambi
 03.9831.14ACB
 03.9831.40ACB
 03.9830.14ACB
 03.9830.40ACB
 05.2157.14ACB
 05.2158.14ACB



Non Dimmable
 05.2310.14A
 05.2311.14A
 Dali Version
 05.2310.14ADA
 05.2311.14ADA
 Casambi
 05.2310.14ACB
 05.2311.14ACB



Non Dimmable
 05.2315.14A
 05.2316.14A
 Dali Version
 05.2315.14ADA
 05.2316.14ADA
 Casambi
 05.2315.14ACB
 05.2316.14ACB



Non Dimmable
 05.2350.14A
 05.2351.14A
 Dali Version
 05.2350.14ADA
 05.2351.14ADA
 Casambi
 05.2350.14ACB
 05.2351.14ACB



Non Dimmable
 05.2355.14A
 05.2356.14A
 Dali Version
 05.2355.14ADA
 05.2356.14ADA
 Casambi
 05.2355.14ACB
 05.2356.14ACB



Non Dimmable
 05.2210.14A
 05.2211.14A
 Dali Version
 05.2210.14ADA
 05.2211.14ADA
 Casambi
 05.2210.14ACB
 05.2211.14ACB



Non Dimmable
 05.2215.14A
 05.2216.14A
 Dali Version
 05.2215.14ADA
 05.2216.14ADA
 Casambi
 05.2215.14ACB
 05.2216.14ACB



Non Dimmable
 05.2250.14A
 05.2251.14A
 Dali Version
 05.2250.14ADA
 05.2251.14ADA
 Casambi
 05.2250.14ACB
 05.2251.14ACB



Non Dimmable
 05.2255.14A
 05.2256.14A
 Dali Version
 05.2255.14ADA
 05.2256.14ADA
 Casambi
 05.2255.14ACB
 05.2256.14ACB

LIGHT SHADOW

Light Shadow Surface 4 Spots

Light Source: Power LED DC 900 mA 10,8W - 1080 lm - 2700K/CRI 90 / 10,8W - 1140lm - 3000K/CRI 90

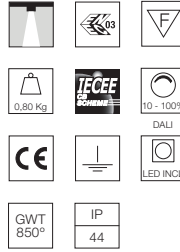
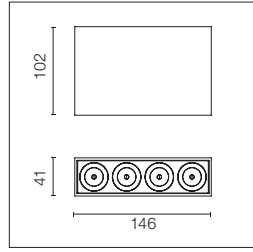

Aufsatzleuchte mit 4 LED-Leuchten. Netzteil 220-240V in der Leuchte integriert.

Surface luminaire with 4 LED lighting spots. Power source 220-240V incorporated.

E= Außenfarbe
I= Innenfarbe
B= Box-Ausführung

E= External Finish
I= Internal Finish
B= Box Finish

Optic Flood 2700K

B	E	I	Non Dimmable
█	█	█	03.9725.40A
█	█	█	03.9725.14A
█	█	█	03.9726.40A
█	█	█	03.9726.14A
█	█	█	05.2122.40A
█	█	█	05.2123.40A
Dali Version			
█	█	█	03.9725.40ADA
█	█	█	03.9725.14ADA
█	█	█	03.9726.40ADA
█	█	█	03.9726.14ADA
█	█	█	05.2122.40ADA
█	█	█	05.2123.40ADA
Casambi			
█	█	█	03.9725.40ACB
█	█	█	03.9725.14ACB
█	█	█	03.9726.40ACB
█	█	█	03.9726.14ACB
█	█	█	05.2122.40ACB
█	█	█	05.2123.40ACB

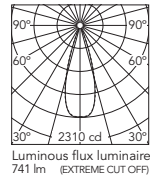

Optic Flood 3000K

B	E	I	Non Dimmable
█	█	█	03.9735.40A
█	█	█	03.9735.14A
█	█	█	03.9736.40A
█	█	█	03.9736.14A
█	█	█	05.2127.40A
█	█	█	05.2128.40A
Dali Version			
█	█	█	03.9735.40ADA
█	█	█	03.9735.14ADA
█	█	█	03.9736.40ADA
█	█	█	03.9736.14ADA
█	█	█	05.2127.40ADA
█	█	█	05.2128.40ADA
Casambi			
█	█	█	03.9735.40ACB
█	█	█	03.9735.14ACB
█	█	█	03.9736.40ACB
█	█	█	03.9736.14ACB
█	█	█	05.2127.40ACB
█	█	█	05.2128.40ACB

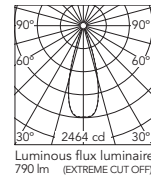

Non Dimmable			
█	█	█	03.9826.14A
█	█	█	03.9826.40A
█	█	█	03.9825.14A
█	█	█	03.9825.40A
█	█	█	05.2162.14A
█	█	█	05.2163.14A
Dali Version			
█	█	█	03.9826.14ADA
█	█	█	03.9826.40ADA
█	█	█	03.9825.14ADA
█	█	█	03.9825.40ADA
█	█	█	05.2162.14ADA
█	█	█	05.2163.14ADA
Casambi			
█	█	█	03.9826.14ACB
█	█	█	03.9826.40ACB
█	█	█	03.9825.14ACB
█	█	█	03.9825.40ACB
█	█	█	05.2162.14ACB
█	█	█	05.2163.14ACB

Non Dimmable			
█	█	█	03.9836.14A
█	█	█	03.9836.40A
█	█	█	03.9835.14A
█	█	█	03.9835.40A
█	█	█	05.2167.14A
█	█	█	05.2168.14A
Dali Version			
█	█	█	03.9836.14ADA
█	█	█	03.9836.40ADA
█	█	█	03.9835.14ADA
█	█	█	03.9835.40ADA
█	█	█	05.2167.14ADA
█	█	█	05.2168.14ADA
Casambi			
█	█	█	03.9836.14ACB
█	█	█	03.9836.40ACB
█	█	█	03.9835.14ACB
█	█	█	03.9835.40ACB
█	█	█	05.2167.14ACB
█	█	█	05.2168.14ACB

Non Dimmable			
█	█	█	05.2320.14A
█	█	█	05.2321.14A
Dali Version			
█	█	█	05.2320.14ADA
█	█	█	05.2321.14ADA
Casambi			
█	█	█	05.2320.14ACB
█	█	█	05.2321.14ACB

Non Dimmable			
█	█	█	05.2220.14A
█	█	█	05.2221.14A
Dali Version			
█	█	█	05.2220.14ADA
█	█	█	05.2221.14ADA
Casambi			
█	█	█	05.2220.14ACB
█	█	█	05.2221.14ACB

Non Dimmable			
█	█	█	05.2325.14A
█	█	█	05.2326.14A
Dali Version			
█	█	█	05.2325.14ADA
█	█	█	05.2326.14ADA
Casambi			
█	█	█	05.2325.14ACB
█	█	█	05.2326.14ACB

Non Dimmable			
█	█	█	05.2225.14A
█	█	█	05.2226.14A
Dali Version			
█	█	█	05.2225.14ADA
█	█	█	05.2226.14ADA
Casambi			
█	█	█	05.2225.14ACB
█	█	█	05.2226.14ACB

Non Dimmable			
█	█	█	05.2360.14A
█	█	█	05.2361.14A
Dali Version			
█	█	█	05.2360.14ADA
█	█	█	05.2361.14ADA
Casambi			
█	█	█	05.2360.14ACB
█	█	█	05.2361.14ACB

Non Dimmable			
█	█	█	05.2260.14A
█	█	█	05.2261.14A
Dali Version			
█	█	█	05.2260.14ADA
█	█	█	05.2261.14ADA
Casambi			
█	█	█	05.2260.14ACB
█	█	█	05.2261.14ACB

Non Dimmable			
█	█	█	05.2365.14A
█	█	█	05.2366.14A
Dali Version			
█	█	█	05.2365.14ADA
█	█	█	05.2366.14ADA
Casambi			
█	█	█	05.2365.14ACB
█	█	█	05.2366.14ACB

Non Dimmable			
█	█	█	05.2265.14A
█	█	█	05.2266.14A
Dali Version			
█	█	█	05.2265.14ADA
█	█	█	05.2266.14ADA
Casambi			
█	█	█	05.2265.14ACB
█	█	█	05.2266.14ACB

Optic Wide Flood 2700K



Non Dimmable
 03.9760.40A
 03.9760.14A
 03.9761.40A
 03.9761.14A
 05.2132.40A
 05.2133.40A



Dali Version
 03.9760.40ADA
 03.9760.14ADA
 03.9761.40ADA
 03.9761.14ADA
 05.2132.40ADA
 05.2133.40ADA



Casambi
 03.9760.40ACB
 03.9760.14ACB
 03.9761.40ACB
 03.9761.14ACB
 05.2132.40ACB
 05.2133.40ACB



Non Dimmable
 03.9861.14A
 03.9861.40A
 03.9860.14A
 03.9860.40A
 05.2172.14A
 05.2173.14A



Dali Version
 03.9861.14ADA
 03.9861.40ADA
 03.9860.14ADA
 03.9860.40ADA
 05.2172.14ADA
 05.2173.14ADA



Casambi
 03.9861.14ACB
 03.9861.40ACB
 03.9860.14ACB
 03.9860.40ACB
 05.2172.14ACB
 05.2173.14ACB



Non Dimmable
 05.2330.14A
 05.2331.14A
 Dali Version
 05.2330.14ADA
 05.2331.14ADA
 Casambi
 05.2330.14ACB
 05.2331.14ACB



Non Dimmable
 05.2370.14A
 05.2371.14A
 Dali Version
 05.2370.14ADA
 05.2371.14ADA
 Casambi
 05.2370.14ACB
 05.2371.14ACB

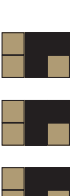

Non Dimmable
 05.2230.14A
 05.2231.14A
 Dali Version
 05.2230.14ADA
 05.2231.14ADA
 Casambi
 05.2230.14ACB
 05.2231.14ACB



Non Dimmable
 05.2270.14A
 05.2271.14A
 Dali Version
 05.2270.14ADA
 05.2271.14ADA
 Casambi
 05.2270.14ACB
 05.2271.14ACB

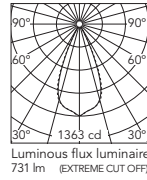

Beam Angle: 45°

h(m)	E(lx)	D(m)
1	1363	0.83
2	341	1.67
3	151	2.50
4	85	3.34
5	55	4.17

Luminous flux luminaire
 731 lm (EXTREME CUT OFF)

@White (40)

Optic Wide Flood 3000K

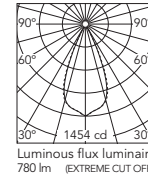

Beam Angle: 45°

h(m)	E(lx)	D(m)
1	1454	0.83
2	363	1.67
3	162	2.50
4	91	3.34
5	58	4.17

Luminous flux luminaire
 780 lm (EXTREME CUT OFF)

@White (40)



Non Dimmable
 03.9764.40A
 03.9764.14A
 03.9765.40A
 03.9765.14A
 05.2137.40A
 05.2138.40A



Dali Version
 03.9764.40ADA
 03.9764.14ADA
 03.9765.40ADA
 03.9765.14ADA
 05.2137.40ADA
 05.2138.40ADA



Casambi
 03.9764.40ACB
 03.9764.14ACB
 03.9765.40ACB
 03.9765.14ACB
 05.2137.40ACB
 05.2138.40ACB



Non Dimmable
 03.9865.14A
 03.9865.40A
 03.9864.14A
 03.9864.40A
 05.2177.14A
 05.2178.14A



Dali Version
 03.9865.14ADA
 03.9865.40ADA
 03.9864.14ADA
 03.9864.40ADA
 05.2177.14ADA
 05.2178.14ADA



Casambi
 03.9865.14ACB
 03.9865.40ACB
 03.9864.14ACB
 03.9864.40ACB
 05.2177.14ACB
 05.2178.14ACB



Non Dimmable
 05.2335.14A
 05.2336.14A
 Dali Version
 05.2335.14ADA
 05.2336.14ADA
 Casambi
 05.2335.14ACB
 05.2336.14ACB



Non Dimmable
 05.2375.14A
 05.2376.14A
 Dali Version
 05.2375.14ADA
 05.2376.14ADA
 Casambi
 05.2375.14ACB
 05.2376.14ACB



Non Dimmable
 05.2235.14A
 05.2236.14A
 Dali Version
 05.2235.14ADA
 05.2236.14ADA
 Casambi
 05.2235.14ACB
 05.2236.14ACB



Non Dimmable
 05.2275.14A
 05.2276.14A
 Dali Version
 05.2275.14ADA
 05.2276.14ADA
 Casambi
 05.2275.14ACB
 05.2276.14ACB

LIGHT SHADOW

Light Shadow Surface 4 Spots Square

Light Source: Power LED DC 900 mA 10,8W - 1080 lm - 2700K/CRI 90 / 10,8W - 1140lm - 3000K/CRI 90
 Mains dimming: Power LED DC 700 mA 9W - 825 lm - 2700K/CRI 90 / 9W - 840 lm - 3000K/CRI 90

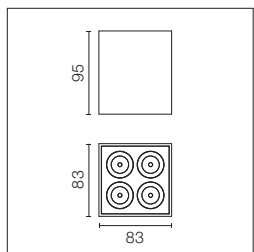

Aufsatzleuchte mit 4 LED-Leuchten.
 Netzteil 220-240V in der Leuchte integriert.

Surface luminaire with 4 LED lighting spots. Power source 220-240V incorporated.

E= Außenfarbe
 I= Innenfarbe
 B= Box-Ausführung

E= External Finish
 I= Internal Finish
 B= Box Finish

Optic Spot 2700K

h(m)	E(lx)	D(m)
1	15829	0.17
2	3957	0.35
3	1759	0.52
4	989	0.70
5	633	0.87

Luminous flux luminaire 865 lm (EXTREME CUT OFF)
 @White (40) 900mA

h(m)	E(lx)	D(m)
1	12690	0.17
2	3173	0.35
3	1410	0.52
4	793	0.70
5	508	0.87

Luminous flux luminaire 694 lm (EXTREME CUT OFF)
 @White (40) 700mA

h(m)	E(lx)	D(m)
1	12921	0.17
2	3230	0.35
3	1436	0.52
4	808	0.70
5	517	0.87

Luminous flux luminaire 706 lm (EXTREME CUT OFF)
 @White (40) 700mA

h(m)	E(lx)	D(m)
1	12921	0.17
2	3230	0.35
3	1436	0.52
4	808	0.70
5	517	0.87

Luminous flux luminaire 706 lm (EXTREME CUT OFF)
 @White (40) 700mA

Optic Spot 3000K

h(m)	E(lx)	D(m)
1	16162	0.17
2	4040	0.35
3	1796	0.52
4	1010	0.70
5	647	0.87

Luminous flux luminaire 883 lm (EXTREME CUT OFF)
 @White (40) 900mA

h(m)	E(lx)	D(m)
1	12921	0.17
2	3230	0.35
3	1436	0.52
4	808	0.70
5	517	0.87

Luminous flux luminaire 706 lm (EXTREME CUT OFF)
 @White (40) 700mA

h(m)	E(lx)	D(m)
1	12921	0.17
2	3230	0.35
3	1436	0.52
4	808	0.70
5	517	0.87

Luminous flux luminaire 706 lm (EXTREME CUT OFF)
 @White (40) 700mA

h(m)	E(lx)	D(m)
1	12921	0.17
2	3230	0.35
3	1436	0.52
4	808	0.70
5	517	0.87

Luminous flux luminaire 706 lm (EXTREME CUT OFF)
 @White (40) 700mA

h(m)	E(lx)	D(m)
1	12921	0.17
2	3230	0.35
3	1436	0.52
4	808	0.70
5	517	0.87

Luminous flux luminaire 706 lm (EXTREME CUT OFF)
 @White (40) 700mA

h(m)	E(lx)	D(m)
1	12921	0.17
2	3230	0.35
3	1436	0.52
4	808	0.70
5	517	0.87

Luminous flux luminaire 706 lm (EXTREME CUT OFF)
 @White (40) 700mA

h(m)	E(lx)	D(m)
1	12921	0.17
2	3230	0.35
3	1436	0.52
4	808	0.70
5	517	0.87

Luminous flux luminaire 706 lm (EXTREME CUT OFF)
 @White (40) 700mA

h(m)	E(lx)	D(m)
1	12921	0.17
2	3230	0.35
3	1436	0.52
4	808	0.70
5	517	0.87

Luminous flux luminaire 706 lm (EXTREME CUT OFF)
 @White (40) 700mA

Optic Medium 2700K



Non Dimmable
 05.0710.40
 05.0710.14
 05.0711.40
 05.0711.14
 05.0712.40
 05.0713.40



Dali Version
 05.0710.40.DA
 05.0710.14.DA
 05.0711.40.DA
 05.0711.14.DA
 05.0712.40.DA
 05.0713.40.DA

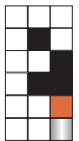

Mains Dimming
 05.0710.40.NI
 05.0710.14.NI
 05.0711.40.NI
 05.0711.14.NI
 05.0712.40.NI
 05.0713.40.NI

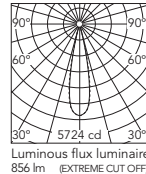

Beam Angle: 22°

h(m)	E(lx)	D(m)
1	5724	0.39
2	1431	0.78
3	636	1.17
4	358	1.56
5	229	1.95

Luminous flux luminaire
 5724 lm (EXTREME CUT OFF)

@White (40) 900mA

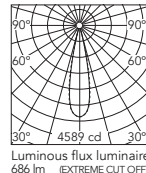

Beam Angle: 22°

h(m)	E(lx)	D(m)
1	4589	0.39
2	1147	0.78
3	510	1.17
4	287	1.56
5	184	1.95

Luminous flux luminaire
 4589 lm (EXTREME CUT OFF)

@White (40) 700mA

Optic Medium 3000K



Non Dimmable
 05.0715.40
 05.0715.14
 05.0716.40
 05.0716.14
 05.0717.40
 05.0718.40

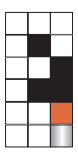

Dali Version
 05.0715.40.DA
 05.0715.14.DA
 05.0716.40.DA
 05.0716.14.DA
 05.0717.40.DA
 05.0718.40.DA



Mains Dimming
 05.0715.40.NI
 05.0715.14.NI
 05.0716.40.NI
 05.0716.14.NI
 05.0717.40.NI
 05.0718.40.NI

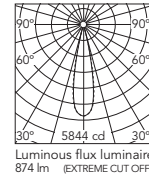

Beam Angle: 22°

h(m)	E(lx)	D(m)
1	5844	0.39
2	1461	0.78
3	650	1.17
4	365	1.56
5	233	1.95

Luminous flux luminaire
 5844 lm (EXTREME CUT OFF)

@White (40) 900mA

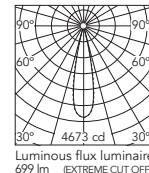

Beam Angle: 22°

h(m)	E(lx)	D(m)
1	4673	0.39
2	1168	0.78
3	519	1.17
4	292	1.56
5	187	1.95

Luminous flux luminaire
 4673 lm (EXTREME CUT OFF)

@White (40) 700mA



Non Dimmable
 05.0751.14
 05.0751.40
 05.0750.14
 05.0750.40
 05.0752.14
 05.0753.14



Dali Version
 05.0751.14.DA
 05.0751.40.DA
 05.0750.14.DA
 05.0750.40.DA
 05.0752.14.DA
 05.0753.14.DA



Mains Dimming
 05.0751.14.NI
 05.0751.40.NI
 05.0750.14.NI
 05.0750.40.NI
 05.0752.14.NI
 05.0753.14.NI



Non Dimmable
 05.0756.14
 05.0756.40
 05.0755.14
 05.0755.40
 05.0757.14
 05.0758.14



Dali Version
 05.0756.14.DA
 05.0756.40.DA
 05.0755.14.DA
 05.0755.40.DA
 05.0757.14.DA
 05.0758.14.DA



Mains Dimming
 05.0756.14.NI
 05.0756.40.NI
 05.0755.14.NI
 05.0755.40.NI
 05.0757.14.NI
 05.0758.14.NI

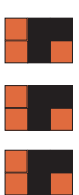

Non Dimmable
 05.0910.14
 05.0911.14
 Dali Version
 05.0910.14.DA
 05.0911.14.DA
 Mains Dimming
 05.0910.14.NI
 05.0911.14.NI

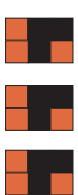

Non Dimmable
 05.0915.14
 05.0916.14
 Dali Version
 05.0915.14.DA
 05.0916.14.DA
 Mains Dimming
 05.0915.14.NI
 05.0916.14.NI



Non Dimmable
 05.0950.14
 05.0951.14
 Dali Version
 05.0950.14.DA
 05.0951.14.DA
 Mains Dimming
 05.0950.14.NI
 05.0951.14.NI



Non Dimmable
 05.0955.14
 05.0956.14
 Dali Version
 05.0955.14.DA
 05.0956.14.DA
 Mains Dimming
 05.0955.14.NI
 05.0956.14.NI

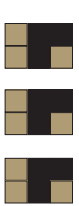

Non Dimmable
 05.0810.14
 05.0811.14
 Dali Version
 05.0810.14.DA
 05.0811.14.DA
 Mains Dimming
 05.0810.14.NI
 05.0811.14.NI

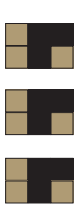

Non Dimmable
 05.0815.14
 05.0816.14
 Dali Version
 05.0815.14.DA
 05.0816.14.DA
 Mains Dimming
 05.0815.14.NI
 05.0816.14.NI



Non Dimmable
 05.0850.14
 05.0851.14
 Dali Version
 05.0850.14.DA
 05.0851.14.DA
 Mains Dimming
 05.0850.14.NI
 05.0851.14.NI



Non Dimmable
 05.0855.14
 05.0856.14
 Dali Version
 05.0855.14.DA
 05.0856.14.DA
 Mains Dimming
 05.0855.14.NI
 05.0856.14.NI

Optic Wide Flood 2700K

Non Dimmable

B	E	I
05.0730.40		
05.0730.14		
05.0731.40		
05.0731.14		
05.0732.40		
05.0733.40		

Dali Version

05.0730.40.DA
05.0730.14.DA
05.0731.40.DA
05.0731.14.DA
05.0732.40.DA
05.0733.40.DA

Mains Dimming

05.0730.40.NI
05.0730.14.NI
05.0731.40.NI
05.0731.14.NI
05.0732.40.NI
05.0733.40.NI

Non Dimmable

05.0771.14
05.0771.40
05.0770.14
05.0770.40
05.0772.14
05.0773.14

Dali Version

05.0771.14.DA
05.0771.40.DA
05.0770.14.DA
05.0770.40.DA
05.0772.14.DA
05.0773.14.DA

Mains Dimming

05.0771.14.NI
05.0771.40.NI
05.0770.14.NI
05.0770.40.NI
05.0772.14.NI
05.0773.14.NI

Non Dimmable

05.0930.14
05.0931.14

Dali Version

05.0930.14.DA
05.0931.14.DA

Mains Dimming

05.0930.14.NI
05.0931.14.NI

Non Dimmable

05.0970.14
05.0971.14

Dali Version

05.0970.14.DA
05.0971.14.DA

Mains Dimming

05.0970.14.NI
05.0971.14.NI

Non Dimmable

05.0830.14
05.0831.14

Dali Version

05.0830.14.DA
05.0831.14.DA

Mains Dimming

05.0830.14.NI
05.0831.14.NI

Non Dimmable

05.0870.14
05.0871.14

Dali Version

05.0870.14.DA
05.0871.14.DA

Mains Dimming

05.0870.14.NI
05.0871.14.NI

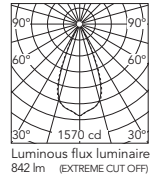

Beam Angle: 45°

h(m)	E(lx)	D(m)
1	1570	0.83
2	392	1.67
3	174	2.50
4	98	3.34
5	63	4.17

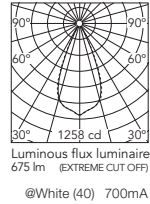

Beam Angle: 45°

h(m)	E(lx)	D(m)
1	1258	0.83
2	315	1.67
3	140	2.50
4	79	3.34
5	50	4.17

Optic Wide Flood 3000K

Non Dimmable

B	E	I
05.0735.40		
05.0735.14		
05.0736.40		
05.0736.14		
05.0737.40		
05.0738.40		

Dali Version

05.0735.40.DA
05.0735.14.DA
05.0736.40.DA
05.0736.14.DA
05.0737.40.DA
05.0738.40.DA

Mains Dimming

05.0735.40.NI
05.0735.14.NI
05.0736.40.NI
05.0736.14.NI
05.0737.40.NI
05.0738.40.NI

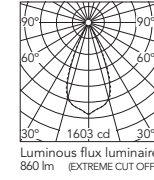

Beam Angle: 45°

h(m)	E(lx)	D(m)
1	1603	0.83
2	401	1.67
3	178	2.50
4	100	3.34
5	64	4.17

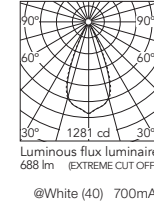

Beam Angle: 45°

h(m)	E(lx)	D(m)
1	1281	0.83
2	320	1.67
3	142	2.50
4	80	3.34
5	51	4.17

Non Dimmable

05.0776.14
05.0776.40
05.0775.14
05.0775.40
05.0777.14
05.0778.14

Dali Version

05.0776.14.DA
05.0776.40.DA
05.0775.14.DA
05.0775.40.DA
05.0777.14.DA
05.0778.14.DA

Mains Dimming

05.0776.14.NI
05.0776.40.NI
05.0775.14.NI
05.0775.40.NI
05.0777.14.NI
05.0778.14.NI

Non Dimmable

05.0935.14
05.0936.14

Dali Version

05.0935.14.DA
05.0936.14.DA

Mains Dimming

05.0935.14.NI
05.0936.14.NI

Non Dimmable

05.0975.14
05.0976.14

Dali Version

05.0975.14.DA
05.0976.14.DA

Mains Dimming

05.0975.14.NI
05.0976.14.NI

Non Dimmable

05.0835.14
05.0836.14

Dali Version

05.0835.14.DA
05.0836.14.DA

Mains Dimming

05.0835.14.NI
05.0836.14.NI

Non Dimmable

05.0875.14
05.0876.14

Dali Version

05.0875.14.DA
05.0876.14.DA

Mains Dimming

05.0875.14.NI
05.0876.14.NI

LIGHT SHADOW PRO&DOTS

DESIGNED BY FLOS ARCHITECTURAL

DOTS Ø30
FIXED

LIGHT SOURCE
POWER LED
3W
270 lm
2700K/CRI 90
285 lm
3000K/CRI 90

PRO Ø60
FIXED

LIGHT SOURCE
LED ARRAY
Up to 15W
1325 lm
2700K/CRI 90
1427 lm
3000K/CRI 90
1515 lm
4000K/CRI 90

PRO Ø60
ADJUSTABLE

LIGHT SOURCE
LED ARRAY
10,5W
1035 lm
2700K/CRI 90
1115 lm
3000K/CRI 90
1185 lm
4000K/CRI 90

PRO Ø90
FIXED

LIGHT SOURCE
LED ARRAY
Up to 22W
2324 lm
2700K/CRI 90
2419 lm
3000K/CRI 90
2520 lm
4000K/CRI 90

PRO Ø90
ADJUSTABLE

LIGHT SOURCE
LED ARRAY
Up to 18W
1590 lm
2700K/CRI 90
1710 lm
3000K/CRI 90
1815 lm
4000K/CRI 90

HIGH COMFORT

■ 14 Schwarz
14 Black



□ 40 Weiss
40 White



■ ER Stahl
ER Steel



■ ES Bronze
ES Bronze



■ EQ Kupfer
EQ Copper



Produktbeschreibung

Einbauinnenleuchten. Diese sind die natürliche Weiterentwicklung von Light Shadow, nun in den Versionen Dots und Pro. Dank ihren wichtigsten Eigenschaften (geringe Größen, Leistung und optimale Abschirmung) ermöglichen sie eine vollständige Einbindung in zahlreiche Räume.

Diese Produktgruppe entstand aus dem Bedarf an einer vollständig verborgenen, kompakten und einfach zu installierenden Leuchte mit dem unverwechselbaren Stil von Flos, die für eine hocheffiziente Beleuchtung sorgt und zugleich die höchsten Standards bezüglich visuellem Komfort erfüllt, insbesondere bei den Versionen, deren Abschirmung schwarz ist. Die neuen PRO-Versionen sind das Ergebnis einer gründlichen optischen Recherche. Doppelte Fokulinse, die speziell für diese Produkte von FLOS entwickelt wurde. Sie garantiert die maximale optische Kontrolle und eine außergewöhnliche Homogenität des Lichtstrahls. Light Shadow Pro nutzt die Vorteile einer innovativen, mikrostrukturierten Silikonlinse, die eine gute Kontrolle ermöglicht und für absolute Effizienz, Hitzebeständigkeit und maximale Qualität bei der Lichtverteilung sorgt. Sie beinhaltet ein LED Array mit einer innovativen Lichtprojektionsbearbeitung, die eine sehr enge Optik und Allgemeinbeleuchtung ermöglicht. Vollständig integrierter "cut-off"-Dimmer. Das optische Set beinhaltet 5 unterschiedliche Lichtstrahlöffnungen, von denen jede einzelne für eine besondere Anwendung entwickelt wurde. Ob intensiver Lichtstrahl oder Streulichteffekt, die optische Steuerung ist stets außergewöhnlich und es kommt zu keinem Lichtabfall.

Optisches System

- Light Shadow Dots 1/2/4 spots: Spot, Medium, Flood, Wide Flood. 2700K, 3000K.
- Light Shadow Pro Ø60 Super Spot, Spot, Medium, Flood, Wide Flood. 2700K, 3000K, 4000K.
- Light Shadow Pro Ø90 Super Spot, Spot, Medium, Flood, Wide Flood. 2700K, 3000K, 4000K.

Die Produktgruppe wird mit Superakzentoptik, Akzentoptik und Allgemeinbeleuchtung angeboten.

Um Lösungen für dekorative Umgebungen zu bieten, wurde die folgende Farbpalette mit verschiedenen Innenausstattungen entwickelt: Weiß, Stahl, Bronze, Kupfer und Schwarz.

Die schwarze Ausführung sorgt für den höchsten optischen Komfort, vermeidet blendendes Licht und verringert den Winkel, aus dem die LED direkt sichtbar ist.

Einspeisung

Fernsteuervorrichtung nicht enthalten, ist separat gemäß Empfehlungen zu bestellen.

Dimmbare Versionen sind über 0-10V, Dali, Netzdimmen und Casambi erhältlich.

Für die Steuerung mittels Casambi (maximal 200 Leuchten) muss die App FLOS Control® powered by Casambi für Mobilgeräte heruntergeladen werden (erhältlich im Apple Store und auf Google Play). 110V-Einheiten auf Anfrage erhältlich.

Zubehör

Der Installationsrahmen aus Kunststoff ist für den Einbau in abgehängten Decken immer erforderlich und muss separat bestellt werden.

Die Version Pro ist in den Versionen Trim und No Trim erhältlich.

Die Version Dots ist nur in der Version No Trim erhältlich.

Der Installationsrahmen muss separat bestellt werden und in einigen Fällen ist ein Fernzugriff auf den Treiber erforderlich. Um einen einzigen Treiber für mehrere Spots zu verwenden, ist eine Reihenschaltung vorzunehmen. Bei der Version Dots muss der Treiber direkt mit den Einbaurahmen verbunden werden.

Zusatzinformationen

Installationsrahmen sind für den Einbau in maximal 25mm dicken Decken vorgesehen.

Schutzgrad IP20, IP23, IP54 je nach Modell.

Schutzklasse II.

Auf normal entflammaren Oberflächen einsetzbar.

Qualitätszeichen

Das Gerät entspricht der europäischen technischen Norm EN60598-1 und den entsprechenden Zusatzregelungen.

Description

Recessed indoor luminaires. The natural evolution of Light Shadow, now available in Dots and Pro versions.

Due to their main qualities (reduced size, high performance and great screening), they facilitate total integration into spaces.

The family was born of the need for a compact, easy to- install luminaire, with the distinctive Flos style, able to produce high efficiency lighting, while respecting the highest standards of visual comfort, in versions with black screening bodies.

The new Pro versions are the result of a careful optical research. Dual focus lens specifically developed by FLOS for these products. Ensures maximum optical control and exceptionally even light beams. Light Shadow Pro takes advantage of an innovative micro-textured silicone lens that allows extreme control as well as providing absolute efficiency, heat resistance and maximum quality in light distribution. It incorporates an LED Array with an innovative light projection treatment that allows very narrow optics and general lighting. Integrated full cut-off.

The optical kit available includes 5 differentiated beam openings, each developed for a specific target application. Whether it's intensive beams or diffused light effects, optical control is always exceptional and fall-off is totally absent.

Optical system

- Light Shadow Dots 1/2/4 spots: Spot, Medium, Flood, Wide Flood. 2700K, 3000K.

- Light Shadow Pro Ø60 Super Spot, Spot, Medium, Flood, Wide Flood. 2700K, 3000K, 4000K.

- Light Shadow Pro Ø90 Super Spot, Spot, Medium, Flood, Wide Flood. 2700K, 3000K, 4000K.

The family is offered with super narrow, accent and general lighting optics.

To provide solutions for more decorative environments, the following range of colors has been developed with different interior finishes: white, steel, bronze, copper and black.

The black finish brings maximum visual comfort, avoids glare and totally hides the LED source from direct view.

Power Supply

Remote equipment not included.

Dimmable versions available via 0-10V, Dali, Mains dimming and Casambi.

For Casambi management (Max. 200 luminaires) it is mandatory to use fixtures in the Casambi version.

For managing and controlling the Casambi system, the FLOS Control® app powered by Casambi for mobile devices is necessary (available in the Apple Store and Google Play).

110V units available on request.

Accessories

The pre-installation frame made of plastic material is always required for installation in false ceiling, to be ordered separately.

The Pro version is available in the Trim and No Trim versions.

The Dots version is only available in the No Trim version.

The installation frame must be ordered separately and remote access to the driver is necessary in some cases. To use only one driver for various spots, connect the spots in series. The driver should be connected directly to the recessed frames in the Dots version.

Additional Information

Installation frames are designed for installation on ceilings up to 25mm of thickness.

IP20, IP23, IP54 protection grade depending on the versions.

Insulation class III.

Suitable for installation on normally inflammable surfaces.

Standard Compliance and Quality Marks

EN60598-1 European Technical Standards and any subsequent additions.

FLOS
CONTROL BY CASAMBI



LIGHT SHADOW DOTS

Light Shadow DOTS Ø30 - Single Spot Module

Light Source: Power LED DC 900 mA - 3W - 270 lm - 2700K/CRI 90 / 3W - 285 lm - 3000K/CRI 90
 Set of 1 spot mains dimming. Power LED DC 750 mA - 2,5W - 222 lm - 2700K/CRI 90 / 2,5W - 235 lm - 3000K/CRI 90

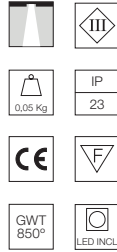
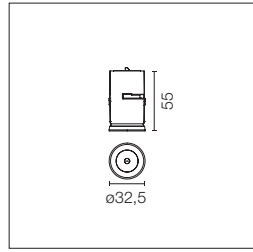

LED-Beleuchtungsmodul mit geringer Blendung, zum Einsetzen in die Einbaurahmen (nicht inbegriffen). Installation durch ein Bajonettsystem mit austauschbaren Scheinwerfern. Erhältlich in Versionen mit einem Licht und in Gruppen von zwei und vier Leuchten. Treiber nicht im Lieferumfang enthalten, der Treiber stellt eine direkte Verbindung zu den Einbettungsrahmen her.

LED lighting module, with low glare, to be inserted in the recessed frames (not included), installation through a bayonet system with interchangeable spots. Available in one-light versions and groups of two and four lights. Driver not included, the driver has to be directly connected to the embedding frames.

2700K

Set of 1 spot

- 03.8600.40A
- 03.8600.14A
- 03.8600.ERA
- 03.8600.ESA
- 03.8600.EQA

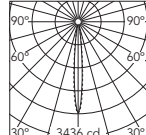

Beam Angle: 10°

h(m)	E(lx)	D(m)
1	3436	0.17
2	859	0.35
3	382	0.52
4	215	0.70
5	137	0.87

Luminous flux luminaire: 188 lm (EXTREME CUT OFF)
 3436 cd

Set of 2 spots

- 03.8640.40A
- 03.8640.14A
- 03.8640.ERA
- 03.8640.ESA
- 03.8640.EQA

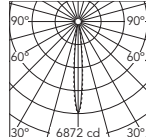

Beam Angle: 10°

h(m)	E(lx)	D(m)
1	6872	0.17
2	1718	0.35
3	764	0.52
4	429	0.70
5	275	0.87

Luminous flux luminaire: 376 lm (EXTREME CUT OFF)
 6872 cd

Set of 4 spots

- 03.8610.40A
- 03.8610.14A
- 03.8610.ERA
- 03.8610.ESA
- 03.8610.EQA

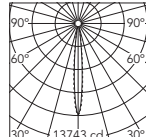

Beam Angle: 10°

h(m)	E(lx)	D(m)
1	13743	0.17
2	3436	0.35
3	1527	0.52
4	859	0.70
5	550	0.87

Luminous flux luminaire: 751 lm (EXTREME CUT OFF)
 @White (40) 900mA
 13743 cd

2700K

Set of 1 spot

- 03.8601.40A
- 03.8601.14A
- 03.8601.ERA
- 03.8601.ESA
- 03.8601.EQA

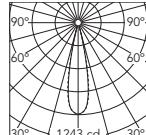

Beam Angle: 22°

h(m)	E(lx)	D(m)
1	1243	0.39
2	311	0.78
3	138	1.17
4	78	1.56
5	50	1.95

Luminous flux luminaire: 186 lm (EXTREME CUT OFF)
 1243 cd

Set of 2 spots

- 03.8641.40A
- 03.8641.14A
- 03.8641.ERA
- 03.8641.ESA
- 03.8641.EQA

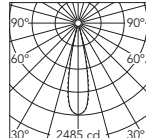

Beam Angle: 22°

h(m)	E(lx)	D(m)
1	2485	0.39
2	621	0.78
3	276	1.17
4	155	1.56
5	99	1.95

Luminous flux luminaire: 372 lm (EXTREME CUT OFF)
 2485 cd

Set of 4 spots

- 03.8611.40A
- 03.8611.14A
- 03.8611.ERA
- 03.8611.ESA
- 03.8611.EQA

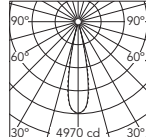

Beam Angle: 22°

h(m)	E(lx)	D(m)
1	4970	0.39
2	1243	0.78
3	552	1.17
4	311	1.56
5	199	1.95

Luminous flux luminaire: 744 lm (EXTREME CUT OFF)
 @White (40) 900mA
 4970 cd

3000K

Set of 1 spot

- 03.8603.40A
- 03.8603.14A
- 03.8603.ERA
- 03.8603.ESA
- 03.8603.EQA

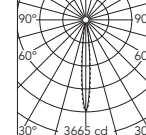

Beam Angle: 10°

h(m)	E(lx)	D(m)
1	3665	0.17
2	916	0.35
3	407	0.52
4	229	0.70
5	147	0.87

Luminous flux luminaire: 200 lm (EXTREME CUT OFF)
 3665 cd

Set of 2 spots

- 03.8643.40A
- 03.8643.14A
- 03.8643.ERA
- 03.8643.ESA
- 03.8643.EQA

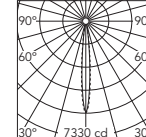

Beam Angle: 10°

h(m)	E(lx)	D(m)
1	7330	0.17
2	1832	0.35
3	814	0.52
4	458	0.70
5	293	0.87

Luminous flux luminaire: 401 lm (EXTREME CUT OFF)
 7330 cd

Set of 4 spots

- 03.8613.40A
- 03.8613.14A
- 03.8613.ERA
- 03.8613.ESA
- 03.8613.EQA

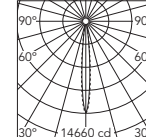

Beam Angle: 10°

h(m)	E(lx)	D(m)
1	14660	0.17
2	3665	0.35
3	1629	0.52
4	916	0.70
5	586	0.87

Luminous flux luminaire: 801 lm (EXTREME CUT OFF)
 @White (40) 900mA
 14660 cd

3000K

Set of 1 spot

- 03.8604.40A
- 03.8604.14A
- 03.8604.ERA
- 03.8604.ESA
- 03.8604.EQA

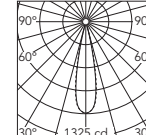

Beam Angle: 22°

h(m)	E(lx)	D(m)
1	1325	0.39
2	331	0.78
3	147	1.17
4	83	1.56
5	53	1.95

Luminous flux luminaire: 198 lm (EXTREME CUT OFF)
 1325 cd

Set of 2 spots

- 03.8644.40A
- 03.8644.14A
- 03.8644.ERA
- 03.8644.ESA
- 03.8644.EQA

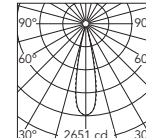

Beam Angle: 22°

h(m)	E(lx)	D(m)
1	2651	0.39
2	663	0.78
3	295	1.17
4	166	1.56
5	106	1.95

Luminous flux luminaire: 397 lm (EXTREME CUT OFF)
 2651 cd

Set of 4 spots

- 03.8614.40A
- 03.8614.14A
- 03.8614.ERA
- 03.8614.ESA
- 03.8614.EQA

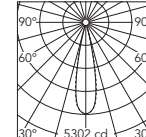

Beam Angle: 22°

h(m)	E(lx)	D(m)
1	5302	0.39
2	1325	0.78
3	589	1.17
4	331	1.56
5	212	1.95

Luminous flux luminaire: 793 lm (EXTREME CUT OFF)
 @White (40) 900mA
 5302 cd

2700K

Set of 1 spot

- 03.8602.40A
- 03.8602.14A
- 03.8602.ERA
- 03.8602.ESA
- 03.8602.EQA

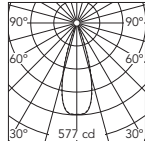

Beam Angle: 33°

h(m)	E(lx)	D(m)
1	577	0.59
2	144	1.18
3	64	1.78
4	36	2.37
5	23	2.96

Luminous flux luminaire
185 lm (EXTREME CUT OFF)

Set of 2 spots

- 03.8642.40A
- 03.8642.14A
- 03.8642.ERA
- 03.8642.ESA
- 03.8642.EQA

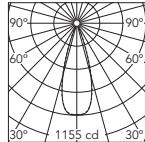

Beam Angle: 33°

h(m)	E(lx)	D(m)
1	1155	0.59
2	289	1.18
3	128	1.78
4	72	2.37
5	46	2.96

Luminous flux luminaire
370 lm (EXTREME CUT OFF)

Set of 4 spots

- 03.8612.40A
- 03.8612.14A
- 03.8612.ERA
- 03.8612.ESA
- 03.8612.EQA

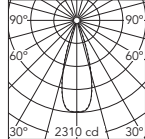

Beam Angle: 33°

h(m)	E(lx)	D(m)
1	2310	0.59
2	577	1.18
3	257	1.78
4	144	2.37
5	92	2.96

Luminous flux luminaire
741 lm (EXTREME CUT OFF)
@White (40) 900mA

2700K

Set of 1 spot

- 03.8630.40A
- 03.8630.14A
- 03.8630.ERA
- 03.8630.ESA
- 03.8630.EQA

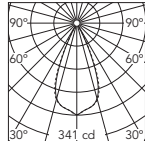

Beam Angle: 45°

h(m)	E(lx)	D(m)
1	341	0.83
2	85	1.67
3	38	2.50
4	21	3.34
5	14	4.17

Luminous flux luminaire
183 lm (EXTREME CUT OFF)

Set of 2 spots

- 03.8646.40A
- 03.8646.14A
- 03.8646.ERA
- 03.8646.ESA
- 03.8646.EQA

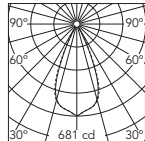

Beam Angle: 45°

h(m)	E(lx)	D(m)
1	681	0.83
2	170	1.67
3	76	2.50
4	43	3.34
5	27	4.17

Luminous flux luminaire
366 lm (EXTREME CUT OFF)

Set of 4 spots

- 03.8635.40A
- 03.8635.14A
- 03.8635.ERA
- 03.8635.ESA
- 03.8635.EQA

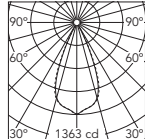

Beam Angle: 45°

h(m)	E(lx)	D(m)
1	1363	0.83
2	341	1.67
3	151	2.50
4	85	3.34
5	55	4.17

Luminous flux luminaire
731 lm (EXTREME CUT OFF)
@White (40) 900mA

3000K

Set of 1 spot

- 03.8605.40A
- 03.8605.14A
- 03.8605.ERA
- 03.8605.ESA
- 03.8605.EQA

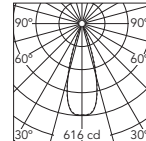

Beam Angle: 33°

h(m)	E(lx)	D(m)
1	616	0.59
2	154	1.18
3	68	1.78
4	38	2.37
5	25	2.96

Luminous flux luminaire
198 lm (EXTREME CUT OFF)

Set of 2 spots

- 03.8645.40A
- 03.8645.14A
- 03.8645.ERA
- 03.8645.ESA
- 03.8645.EQA

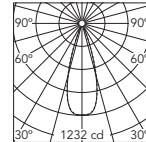

Beam Angle: 33°

h(m)	E(lx)	D(m)
1	1232	0.59
2	308	1.18
3	137	1.78
4	77	2.37
5	49	2.96

Luminous flux luminaire
395 lm (EXTREME CUT OFF)

Set of 4 spots

- 03.8615.40A
- 03.8615.14A
- 03.8615.ERA
- 03.8615.ESA
- 03.8615.EQA

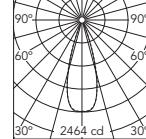

Beam Angle: 33°

h(m)	E(lx)	D(m)
1	2464	0.59
2	616	1.18
3	274	1.78
4	154	2.37
5	99	2.96

Luminous flux luminaire
790 lm (EXTREME CUT OFF)
@White (40) 900mA

3000K

Set of 1 spot

- 03.8631.40A
- 03.8631.14A
- 03.8631.ERA
- 03.8631.ESA
- 03.8631.EQA

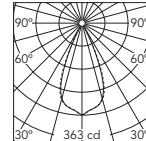

Beam Angle: 45°

h(m)	E(lx)	D(m)
1	363	0.83
2	91	1.67
3	40	2.50
4	23	3.34
5	15	4.17

Luminous flux luminaire
195 lm (EXTREME CUT OFF)

Set of 2 spots

- 03.8647.40A
- 03.8647.14A
- 03.8647.ERA
- 03.8647.ESA
- 03.8647.EQA

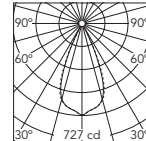

Beam Angle: 45°

h(m)	E(lx)	D(m)
1	727	0.83
2	182	1.67
3	81	2.50
4	45	3.34
5	29	4.17

Luminous flux luminaire
390 lm (EXTREME CUT OFF)

Set of 4 spots

- 03.8636.40A
- 03.8636.14A
- 03.8636.ERA
- 03.8636.ESA
- 03.8636.EQA

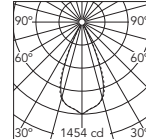

Beam Angle: 45°

h(m)	E(lx)	D(m)
1	1454	0.83
2	363	1.67
3	162	2.50
4	91	3.34
5	58	4.17

Luminous flux luminaire
780 lm (EXTREME CUT OFF)
@White (40) 900mA

LIGHT SHADOW DOTS

Zubehör / Accessories

Dots No Trim

Montagerahmen.
Pre-installation frame. 1L
08.0580.00

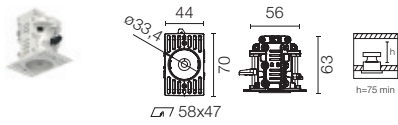

Montagerahmen.
Pre-installation frame. 2L - Int 70
08.0583.00



Montagerahmen.
Pre-installation frame. 2L - Int 43
08.0581.00

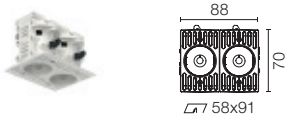

Montagerahmen.
Pre-installation frame. 4L - Int 70
08.0584.00

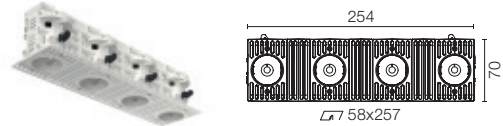

Montagerahmen.
Pre-installation frame. 4L - Int 43
08.0582.00

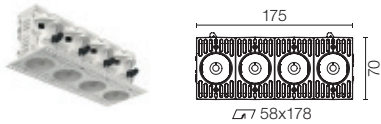

70-mm-Separator zur
Aufrechterhaltung des Abstands
zwischen den Lampen durch
Verbinden von 70-mm-Modulen.
08.0586.00

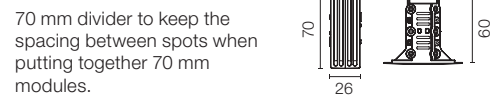

Dots Trim

Montagerahmen.
Pre-installation frame. 1L
08.0661.40
08.0661.14

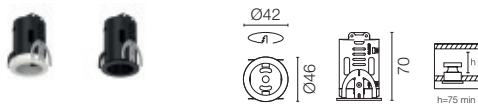

LIGHT SHADOW DOTS

Treiber / Drivers

Nicht regulierbares Konstantstrom-Netzgerät mit 15W (110V) - 20W (240V) - 50/60Hz, mit Stromwahl durch nicht einstellbaren Schalter 900 mA.

Non dimmable continuous current power supply of 15W (110V) - 20W (240V) - 50/60Hz, with power current selected through non-adjustable 900 mA switch.

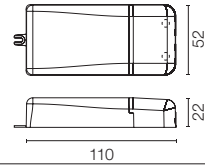

1/2/4L - No Dim
60.8911

Konstantstrom-Netzgerät mit 13-38W, 220/240V - 50/60Hz mit Stromwahl durch nicht einstellbaren Schalter 900 mA.

Continuous current power supply of 13-38W, 220/240V - 50/60Hz with power current selected through non-adjustable 900 mA switch.

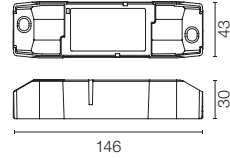

2/4L - No Dim
60.9162

Mains Konstantstrom Speisequelle, regulierbar, leading & trailing edge 220/240V - 50/60Hz, 300mA - 14W / 350 mA - 17W / 400 mA - 19W / 450/500/600/650/700/750/800/900 mA - 20W.

Continuous current power supply, Mains dimming, leading & trailing edge 220/240V - 50/60Hz, 300mA - 14W / 350 mA - 17W / 400 mA - 19W / 450/500/600/650/700/750/800/900 mA - 20W.

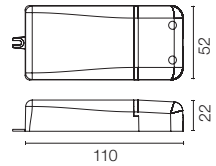

2/4L - Dim Mains dimming
60.9467

Nicht regulierbares Konstantstrom-Netzgerät mit 20W, 0-10V-Dimmung, 220/240V - 50/60Hz mit einem Leistungsstrom von 900 mA.

Non dimmable continuous current power supply of 20W, dimmable 0-10V, 220/240V - 50/60Hz with power current 900 mA.

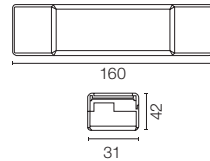

1/2/4L - Dim 0-10V
60.9414

Konstantstrom-Netzgerät mit 20W, DALI 2 Dimmung, 220/240V - 50/60Hz mit einem Leistungsstrom von 900 mA.

Continuous current power supply of 20W, dimmable DALI 2, 220/240V - 50/60Hz with power current 900 mA.

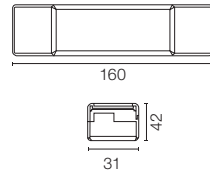

1/2/4L - Dim DALI
60.9602

Konstantstrom-Netzgerät Casambi-Dimmung, mit Stromwahl über Schalter 900 mA 38W, 220/240V - 50/60Hz, 220/240V - 50/60Hz.

Continuous current power supply, dimmable Casambi, with power current selected through 900 mA 38W switch, 220/240V - 50/60Hz.

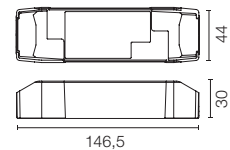

1/2/4L - Casambi
60.9207

Serial connection			
Driver	DIM Protocol	Driving current	Min-Max Spots/Driver
60.8911	No Dim	900	1 - 6
60.9162	No Dim	900	2 - 11
60.9467	Mains Dim	900	2 - 6
60.9414	Dim 0-10V	900	1 - 6
60.9602	Dim DALI	900	1 - 6
60.9207	Casambi	900	2 - 10

HOW TO ORDER LIGHT SHADOW DOTS

Dots Trim

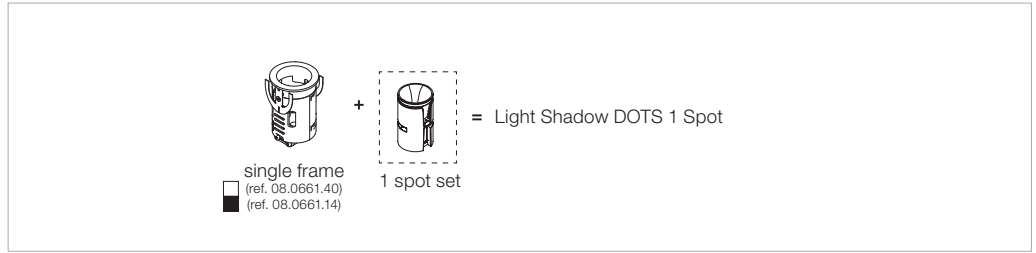
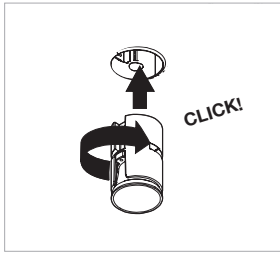

Dots No Trim

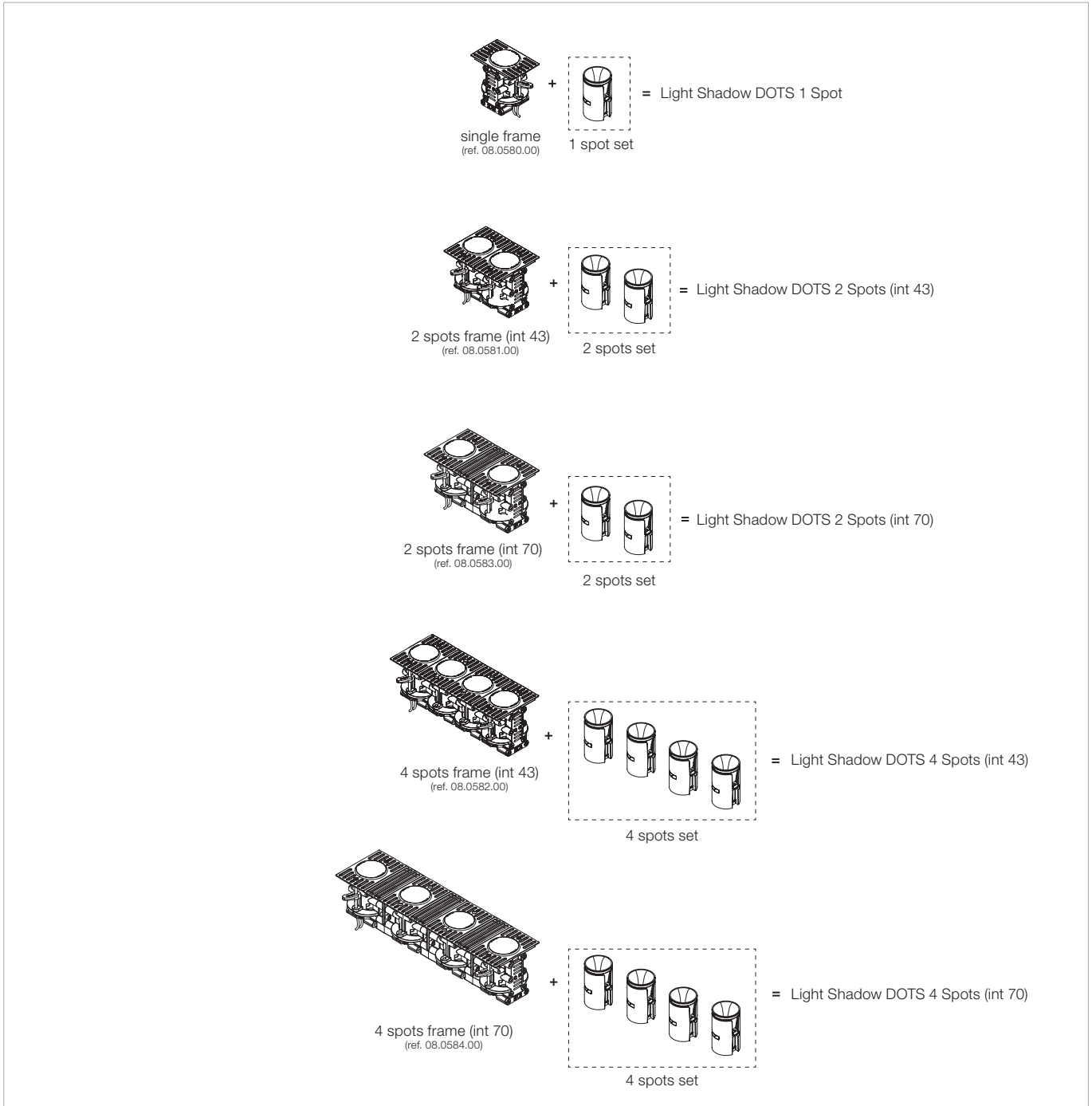

HOW TO ORDER LIGHT SHADOW DOTS

Dots No Trim Bei der Planung der Beleuchtung in einer Umgebung, ermöglicht die Light Shadow Dots-Familie, dank der einfachen Verbindung zwischen den Leuchten (1, 2 und 4 Leuchten), durchgängige Lichtlinien, ohne dass ein zusätzliches Werkzeug erforderlich ist. Bei der Gestaltung und Planung kann zwischen zwei vordefinierten Abständen zwischen den Lichtpunkten (43 und 70 mm) gewählt werden, wodurch für die 70-mm-Version ein unabhängiges Zubehörteil (Ref. 08.0584.00) zwischen den Leuchten montiert werden muss.

When planning the lighting of an environment, the Light Shadow Dots family allows to project continuous light lines or random figures thanks to the simple interconnection between its luminaires (1, 2 and 4 lights) without the need for an additional tool. For the lighting designing and planning, the user can choose between two predefined distances of 43 and 70 mm between light points. For the 70 mm version, it is necessary to assemble an independent accessory (reference: 08.0584.00) between the luminaires.

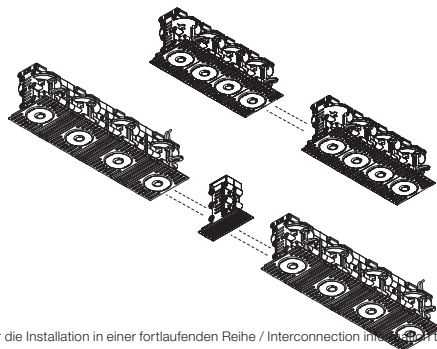

Verbindungsdetail für die Installation in einer fortlaufenden Reihe / Interconnection in order to build a continuous line

Light Shadow PRO Ø60 Fixed

Light Source: LED Array DC Up to 400 mA 15W - 1325 lm - 2700K/CRI 90 / 15W - 1427 lm - 3000K/CRI 90 / 15W - 1515 lm - 4000K/CRI 90
 LED Array DC 300 mA** 11W - 1037lm - 2700K/CRI 90 / 11W - 1117 lm - 3000K/CRI 90 / 11W - 1185 lm - 4000K/CRI 90

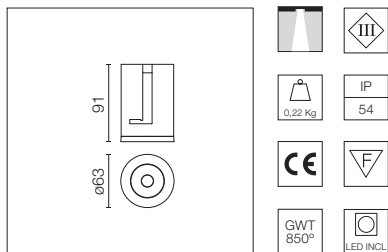

LED-Beleuchtungsmodul mit geringer Blendung für die Einsetzung in Einbaurahmen (nicht inbegriffen). Installation mittels Bajonettssystem mit austauschbaren Spots. Remote-Treiber nicht enthalten.

LED lighting module, with low glare, to be inserted in the recessed frames (not included), installation through a bayonet system with interchangeable spots. Remote driver not included.

**Bitte wählen Sie 300 mA Einstellung im Remote-Treiber, um die Leistung der "Adjustable" Version zu entsprechen.

**Please select 300 mA setting in the remote driver to match the power of the Adjustable version.

Empfohlene Netzgeräte / Recommended power supply*:

	300mA	400mA
Non Dimmable 220-240V	60.9162	60.9162
Mains Dimming	60.9467	60.9467
Dim 1-10V 220-240V	60.9439	60.9439
Dim 1-10V/Push 110-240V	60.9188	60.9188
Dim Dali 2 220-240V	60.9186	60.9186
Dim Dali 2 110-240V	60.9222	60.9222
Dim Casambi	60.9207	60.9207

* Siehe Treiberkapitel / Refer to the Drivers chapter

Optic Spot 2700K

- 03.9950.40
- 03.9950.14
- 03.9950.ER
- 03.9950.ES
- 03.9950.EQ

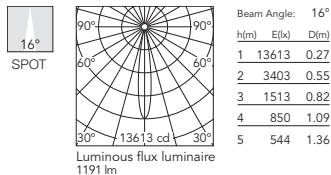

Optic Medium 2700K

- 03.9951.40
- 03.9951.14
- 03.9951.ER
- 03.9951.ES
- 03.9951.EQ

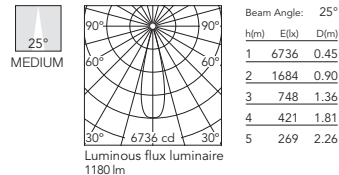

3000K

- 03.9954.40
- 03.9954.14
- 03.9954.ER
- 03.9954.ES
- 03.9954.EQ

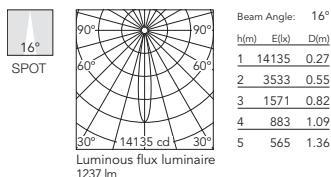

3000K

- 03.9955.40
- 03.9955.14
- 03.9955.ER
- 03.9955.ES
- 03.9955.EQ

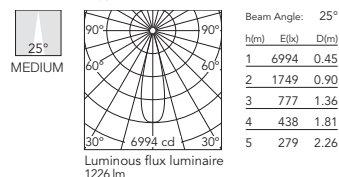

4000K

- 03.9910.40
- 03.9910.14
- 03.9910.ER
- 03.9910.ES
- 03.9910.EQ

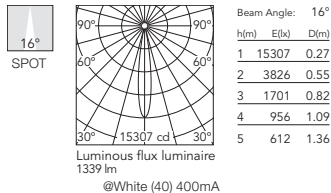

4000K

- 03.9911.40
- 03.9911.14
- 03.9911.ER
- 03.9911.ES
- 03.9911.EQ

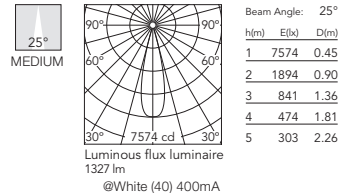

Optic Flood 2700K

- 03.9952.40
- 03.9952.14
- 03.9952.ER
- 03.9952.ES
- 03.9952.EQ

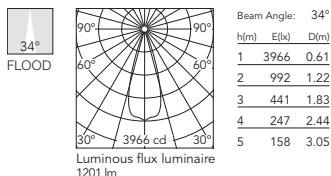

Optic Wide Flood 2700K

- 03.9953.40
- 03.9953.14
- 03.9953.ER
- 03.9953.ES
- 03.9953.EQ

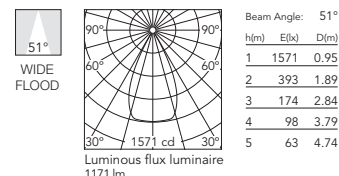

3000K

- 03.9956.40
- 03.9956.14
- 03.9956.ER
- 03.9956.ES
- 03.9956.EQ

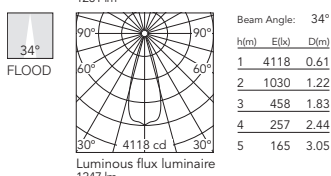

3000K

- 03.9957.40
- 03.9957.14
- 03.9957.ER
- 03.9957.ES
- 03.9957.EQ

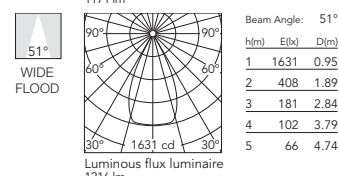

4000K

- 03.9912.40
- 03.9912.14
- 03.9912.ER
- 03.9912.ES
- 03.9912.EQ

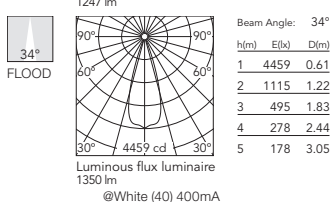

4000K

- 03.9913.40
- 03.9913.14
- 03.9913.ER
- 03.9913.ES
- 03.9913.EQ

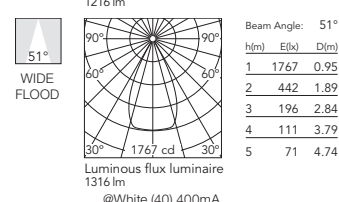

Light Shadow PRO Ø60 Adjustable

Light Source: LED Array DC 800 mA 10,5W - 888 lm - 2700K/CRI 90 / 10,5W - 923 lm - 3000K/CRI 90 / 10,5W - 963 lm - 4000K/CRI 90

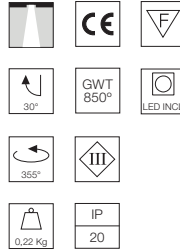
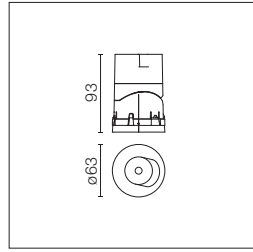

LED-Beleuchtungsmodul mit geringer Blendung für die Einsetzung in Einbaurahmen (nicht inbegriffen) mit austauschbaren Spots. Remote-Treiber nicht enthalten.

LED lighting module, with low glare, to be inserted in the recessed frames (not included), with interchangeable spots. Remote driver not included.

Empfohlene Netzgeräte / Recommended power supply*:

Non Dimmable 220-240V	60.9162
Mains Dimming	60.9467
Dim 1-10V 220-240V	60.9439
Dim 1-10V/Push 110-240V	60.9188
Dim Dali 2 220-240V	60.9186
Dim Casambi	60.9207

* Siehe Treiberkapitel / Refer to the Drivers chapter

Optic Spot 2700K

- 03.9971.40A
- 03.9971.14A
- 03.9971.ERA
- 03.9971.ESA
- 03.9971.EQA

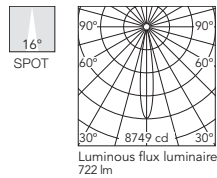

Beam Angle: 16°

h(m)	E(lx)	D(m)
1	8749	0.28
2	2187	0.55
3	972	0.83
4	547	1.11
5	350	1.39

Luminous flux luminaire 722 lm

Optic Medium 2700K

- 03.9972.40A
- 03.9972.14A
- 03.9972.ERA
- 03.9972.ESA
- 03.9972.EQA

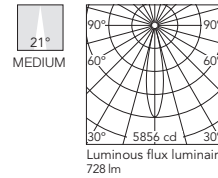

Beam Angle: 21°

h(m)	E(lx)	D(m)
1	5856	0.37
2	1464	0.73
3	651	1.10
4	366	1.47
5	234	1.83

Luminous flux luminaire 728 lm

3000K

- 03.9976.40A
- 03.9976.14A
- 03.9976.ERA
- 03.9976.ESA
- 03.9976.EQA

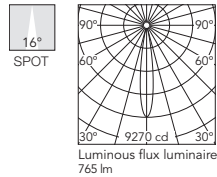

Beam Angle: 16°

h(m)	E(lx)	D(m)
1	9270	0.28
2	2317	0.55
3	1030	0.83
4	579	1.11
5	371	1.39

Luminous flux luminaire 765 lm

3000K

- 03.9977.40A
- 03.9977.14A
- 03.9977.ERA
- 03.9977.ESA
- 03.9977.EQA

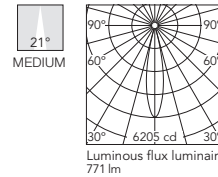

Beam Angle: 21°

h(m)	E(lx)	D(m)
1	6205	0.37
2	1552	0.73
3	689	1.10
4	388	1.47
5	248	1.83

Luminous flux luminaire 771 lm

4000K

- 03.9931.40A
- 03.9931.14A
- 03.9931.ERA
- 03.9931.ESA
- 03.9931.EQA

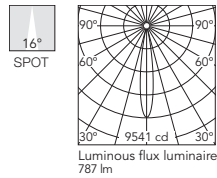

Beam Angle: 16°

h(m)	E(lx)	D(m)
1	9541	0.28
2	2385	0.55
3	1060	0.83
4	596	1.11
5	382	1.39

Luminous flux luminaire 787 lm

4000K

- 03.9932.40A
- 03.9932.14A
- 03.9932.ERA
- 03.9932.ESA
- 03.9932.EQA

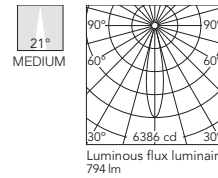

Beam Angle: 21°

h(m)	E(lx)	D(m)
1	6386	0.37
2	1597	0.73
3	710	1.10
4	399	1.47
5	256	1.83

Luminous flux luminaire 794 lm

Optic Flood 2700K

- 03.9973.40A
- 03.9973.14A
- 03.9973.ERA
- 03.9973.ESA
- 03.9973.EQA

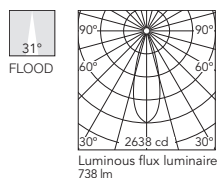

Beam Angle: 31°

h(m)	E(lx)	D(m)
1	2638	0.56
2	659	1.11
3	293	1.67
4	165	2.23
5	106	2.79

Luminous flux luminaire 738 lm

3000K

- 03.9978.40A
- 03.9978.14A
- 03.9978.ERA
- 03.9978.ESA
- 03.9978.EQA

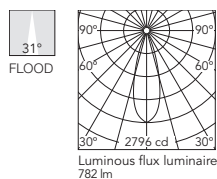

Beam Angle: 31°

h(m)	E(lx)	D(m)
1	2796	0.56
2	699	1.11
3	311	1.67
4	174	2.23
5	112	2.79

Luminous flux luminaire 782 lm

4000K

- 03.9933.40A
- 03.9933.14A
- 03.9933.ERA
- 03.9933.ESA
- 03.9933.EQA

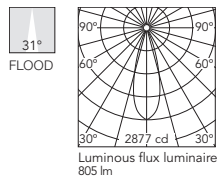

Beam Angle: 31°

h(m)	E(lx)	D(m)
1	2877	0.56
2	719	1.11
3	320	1.67
4	180	2.23
5	115	2.79

Luminous flux luminaire 805 lm

Light Shadow PRO Ø90 Fixed

Light Source: Super Spot: LED Array DC 500 mA 18W - 1590 lm - 2700K/CRI 90 / 18W - 1710 lm - 3000K/CRI 90 / 18W - 1815 lm - 4000K/CRI 90
 S/M/F/WF: LED Array DC 600 mA 22W - 2324 lm - 2700K/CRI 90 / 22W - 2419 lm - 3000K/CRI 90 / 22W - 2520 lm - 4000K/CRI 90
 S/M/F/WF: LED Array DC 550 mA*** 19W - 1962 lm - 2700K/CRI 90 / 19W - 2091 lm - 3000K/CRI 90 / 19W - 2228 lm - 4000K/CRI 90
 S/M/F/WF: LED Array DC 500 mA** 18W - 1803 lm - 2700K/CRI 90 / 18W - 1921 lm - 3000K/CRI 90 / 18W - 2057 lm - 4000K/CRI 90

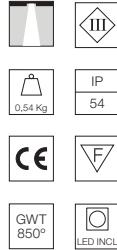
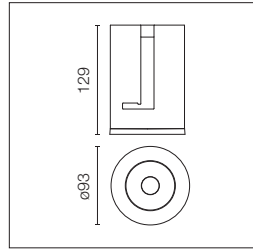

LED-Beleuchtungsmodul mit geringer Blendung für die Einsetzung in Einbaurahmen (nicht inbegriffen). Installation mittels Bajonettsystem mit austauschbaren Spots. Remote-Treiber nicht enthalten.

LED lighting module, with low glare, to be inserted in the recessed frames (not included), installation through a bayonet system with interchangeable spots. Remote driver not included.

**Bitte wählen Sie 500 mA Einstellung im Remote-Treiber, um die Leistung der "Adjustable" Version zu entsprechen.

**Please select 500 mA setting in the remote driver to match the power of the Adjustable version.

Empfohlene Netzgeräte / Recommended power supply*:

	500mA	550mA	600mA
Non Dimmable 220-240V	60.9162		60.9162
Non Dimmable 110-240V	60.9523		60.9523
Mains Dimming	60.9467		60.9467
Mains Dimming***		60.8534	
Dim 1-10V 220-240V	60.9439		60.9439
Dim 1-10V/Push 110-240V	60.9188		60.8533
Dim DALI 2 220-240V	60.9186		60.9186
Dim Casambi	60.9207		60.9207

* Siehe Treiberkapitel / Refer to the Drivers chapter

Optic Super Spot 2700K

- 03.9968.40
- 03.9968.14
- 03.9968.ER
- 03.9968.ES
- 03.9968.EQ

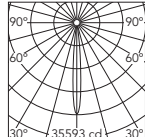

Beam Angle: 10°

h(m)	Et(x)	D(m)
1	35593	0.17
2	8898	0.34
3	3955	0.51
4	2225	0.67
5	1424	0.84

Luminous flux luminaire 1300 lm

Optic Spot 2700K

- 03.9960.40
- 03.9960.14
- 03.9960.ER
- 03.9960.ES
- 03.9960.EQ

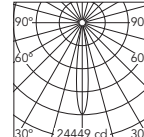

Beam Angle: 14°

h(m)	Et(x)	D(m)
1	24449	0.25
2	6112	0.50
3	2717	0.75
4	1528	1.00
5	978	1.25

Luminous flux luminaire 1786 lm

3000K

- 03.9969.40
- 03.9969.14
- 03.9969.ER
- 03.9969.ES
- 03.9969.EQ

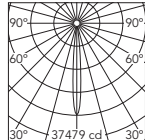

Beam Angle: 10°

h(m)	Et(x)	D(m)
1	37479	0.17
2	9370	0.34
3	4164	0.51
4	2342	0.67
5	1499	0.84

Luminous flux luminaire 1368 lm

3000K

- 03.9964.40
- 03.9964.14
- 03.9964.ER
- 03.9964.ES
- 03.9964.EQ

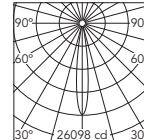

Beam Angle: 14°

h(m)	Et(x)	D(m)
1	26098	0.25
2	6524	0.50
3	2900	0.75
4	1631	1.00
5	1044	1.25

Luminous flux luminaire 1906 lm

4000K

- 03.9924.40
- 03.9924.14
- 03.9924.ER
- 03.9924.ES
- 03.9924.EQ

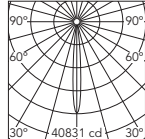

Beam Angle: 10°

h(m)	Et(x)	D(m)
1	40831	0.17
2	10208	0.34
3	4537	0.51
4	2552	0.67
5	1633	0.84

Luminous flux luminaire 1491 lm

@White (40) 500mA

4000K

- 03.9920.40
- 03.9920.14
- 03.9920.ER
- 03.9920.ES
- 03.9920.EQ

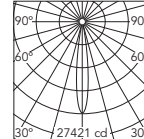

Beam Angle: 14°

h(m)	Et(x)	D(m)
1	27421	0.25
2	6855	0.50
3	3047	0.75
4	1714	1.00
5	1097	1.25

Luminous flux luminaire 2003 lm

@White (40) 600mA

Optic Medium 2700K

- 03.9961.40
- 03.9961.14
- 03.9961.ER
- 03.9961.ES
- 03.9961.EQ

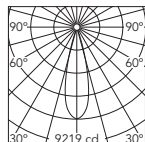

Beam Angle: 27°

h(m)	Et(x)	D(m)
1	9219	0.48
2	2305	0.95
3	1024	1.43
4	576	1.90
5	369	2.38

Luminous flux luminaire 1814 lm

Optic Flood 2700K

- 03.9962.40
- 03.9962.14
- 03.9962.ER
- 03.9962.ES
- 03.9962.EQ

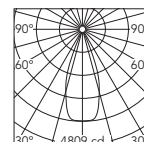

Beam Angle: 39°

h(m)	Et(x)	D(m)
1	4809	0.71
2	1202	1.42
3	534	2.13
4	301	2.85
5	192	3.56

Luminous flux luminaire 1760 lm

3000K

- 03.9965.40
- 03.9965.14
- 03.9965.ER
- 03.9965.ES
- 03.9965.EQ

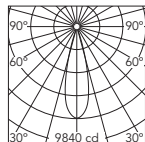

Beam Angle: 27°

h(m)	Et(x)	D(m)
1	9840	0.48
2	2460	0.95
3	1093	1.43
4	615	1.90
5	394	2.38

Luminous flux luminaire 1936 lm

3000K

- 03.9966.40
- 03.9966.14
- 03.9966.ER
- 03.9966.ES
- 03.9966.EQ

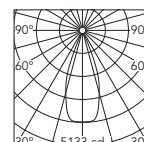

Beam Angle: 39°

h(m)	Et(x)	D(m)
1	5133	0.71
2	1283	1.42
3	570	2.13
4	321	2.85
5	205	3.56

Luminous flux luminaire 1878 lm

4000K

- 03.9921.40
- 03.9921.14
- 03.9921.ER
- 03.9921.ES
- 03.9921.EQ

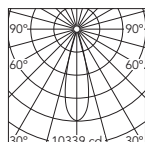

Beam Angle: 27°

h(m)	Et(x)	D(m)
1	10339	0.48
2	2585	0.95
3	1149	1.43
4	646	1.90
5	414	2.38

Luminous flux luminaire 2034 lm

@White (40) 600mA

4000K

- 03.9922.40
- 03.9922.14
- 03.9922.ER
- 03.9922.ES
- 03.9922.EQ

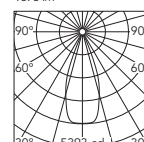





Beam Angle: 39°

h(m)	Et(x)	D(m)
1	5393	0.71
2	1348	1.42
3	599	2.13
4	337	2.85
5	216	3.56

Luminous flux luminaire 1974 lm

@White (40) 600mA

**Optic Wide Flood
2700K**

-  03.9963.40
-  03.9963.14
-  03.9963.ER
-  03.9963.ES
-  03.9963.EQ

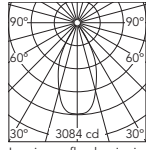





Luminous flux luminaire
1872 lm

Beam Angle: 48°

h(m)	E(lx)	D(m)
1	3084	0.89
2	771	1.79
3	343	2.68
4	193	3.58
5	123	4.47

3000K

-  03.9967.40
-  03.9967.14
-  03.9967.ER
-  03.9967.ES
-  03.9967.EQ

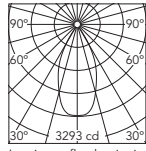

Luminous flux luminaire
1999 lm

Beam Angle: 48°

h(m)	E(lx)	D(m)
1	3293	0.89
2	823	1.79
3	366	2.68
4	206	3.58
5	132	4.47

4000K

-  03.9923.40
-  03.9923.14
-  03.9923.ER
-  03.9923.ES
-  03.9923.EQ

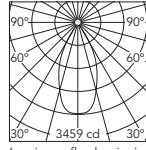

Luminous flux luminaire
2100 lm

Beam Angle: 48°

h(m)	E(lx)	D(m)
1	3459	0.89
2	865	1.79
3	384	2.68
4	216	3.58
5	138	4.47

@White (40) 600mA

LIGHT SHADOW PRO

Light Shadow PRO Ø90 Adjustable

Light Source: Super Spot: LED Array DC 800 mA 10W - 800 lm - 2700K/CRI 90 / 10W - 845 lm - 3000K/CRI 90 / 10W - 915 lm - 4000K/CRI 90
 S/M/F: LED Array DC 500 mA 18W - 1590 lm - 2700K/CRI 90 / 18W - 1710 lm - 3000K/CRI 90 / 18W - 1815 lm - 4000K/CRI 90

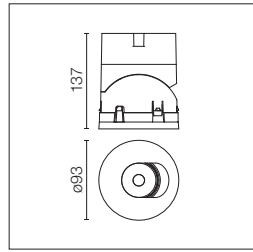

LED-Beleuchtungsmodul mit geringer Blendung für die Einsetzung in Einbaurahmen (nicht inbegriffen) mit austauschbaren Spots. Remote-Treiber nicht enthalten.

LED lighting module, with low glare, to be inserted in the recessed frames (not included), with interchangeable spots. Remote driver not included.

Empfohlene Netzgeräte / Recommended power supply*:

	500mA 18W	800mA 10W
Non Dimmable 220-240V	60.9162	60.9162
Mains Dimming	60.9467	60.9467
Dim 1-10V 220-240V	60.9439	60.9439
Dim 1-10V/Push 110-240V	60.9188	60.9188
Dim Dali 2 220-240V	60.9186	60.9186
Dim Dali 2 110-240V	60.9222	
Dim Casambi	60.9207	60.9207

* Siehe Treiberkapitel / Refer to the Drivers chapter

Optic Super Spot 2700K

- 03.9980.40
- 03.9980.14
- 03.9980.ER
- 03.9980.ES
- 03.9980.EQ

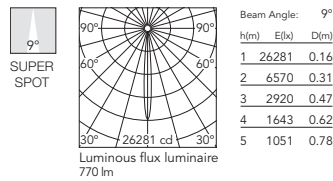

Optic Spot 2700K

- 03.9981.40
- 03.9981.14
- 03.9981.ER
- 03.9981.ES
- 03.9981.EQ

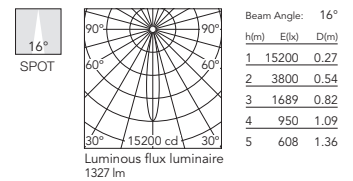

- ### 3000K
- 03.9985.40
 - 03.9985.14
 - 03.9985.ER
 - 03.9985.ES
 - 03.9985.EQ

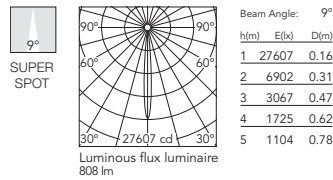

- ### 3000K
- 03.9986.40
 - 03.9986.14
 - 03.9986.ER
 - 03.9986.ES
 - 03.9986.EQ

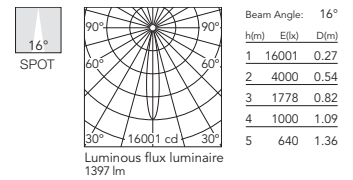

- ### 4000K
- 03.9940.40
 - 03.9940.14
 - 03.9940.ER
 - 03.9940.ES
 - 03.9940.EQ

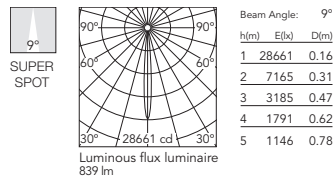

- ### 4000K
- 03.9941.40
 - 03.9941.14
 - 03.9941.ER
 - 03.9941.ES
 - 03.9941.EQ

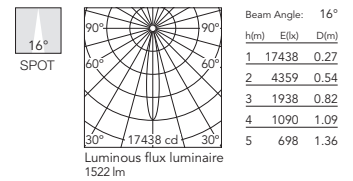

Optic Medium 2700K

- 03.9982.40
- 03.9982.14
- 03.9982.ER
- 03.9982.ES
- 03.9982.EQ

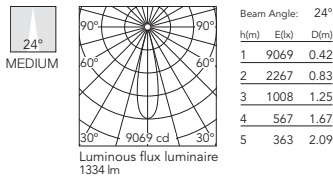

Optic Flood 2700K

- 03.9983.40
- 03.9983.14
- 03.9983.ER
- 03.9983.ES
- 03.9983.EQ

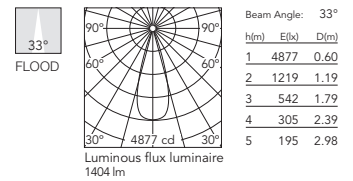

- ### 3000K
- 03.9987.40
 - 03.9987.14
 - 03.9987.ER
 - 03.9987.ES
 - 03.9987.EQ

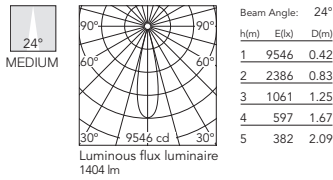

- ### 3000K
- 03.9988.40
 - 03.9988.14
 - 03.9988.ER
 - 03.9988.ES
 - 03.9988.EQ

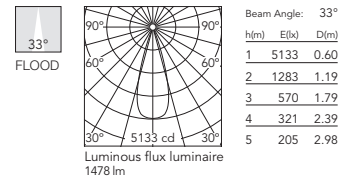

- ### 4000K
- 03.9942.40
 - 03.9942.14
 - 03.9942.ER
 - 03.9942.ES
 - 03.9942.EQ

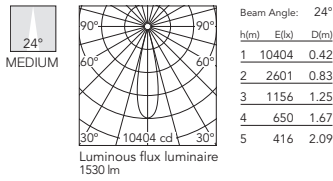

- ### 4000K
- 03.9943.40
 - 03.9943.14
 - 03.9943.ER
 - 03.9943.ES
 - 03.9943.EQ

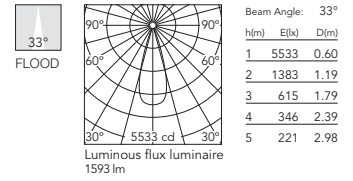

LIGHT SHADOW PRO

Zubehör / Accessories

Vorinstallationsrahmen Trim Ø60.

Frame Trim Ø60.

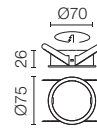

Fixed
 08.0160.40
 08.0160.14

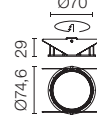

Adjustable
 08.0164.40
 08.0164.14

Vorinstallationsrahmen No Trim Ø60.

Frame No Trim Ø60.



Fixed
 08.0192.00

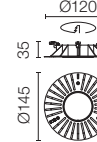

Adjustable
 08.0166.00

Vorinstallationsrahmen Trim Ø90.

Frame Trim Ø90.

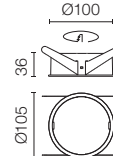

Fixed
 08.0161.40
 08.0161.14

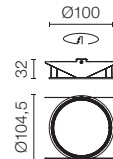

Adjustable
 08.0165.40
 08.0165.14

Vorinstallationsrahmen No Trim Ø90.

Frame No Trim Ø90.

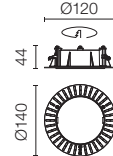

Fixed
 08.0193.00

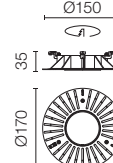

Adjustable
 08.0167.00

HOW TO ORDER LIGHT SHADOW PRO

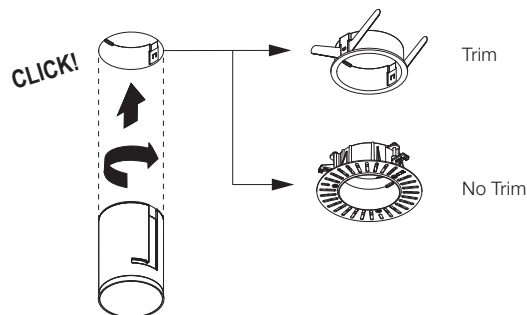

CIRCLE OF LIGHT

DESIGNED BY FLOS ARCHITECTURAL

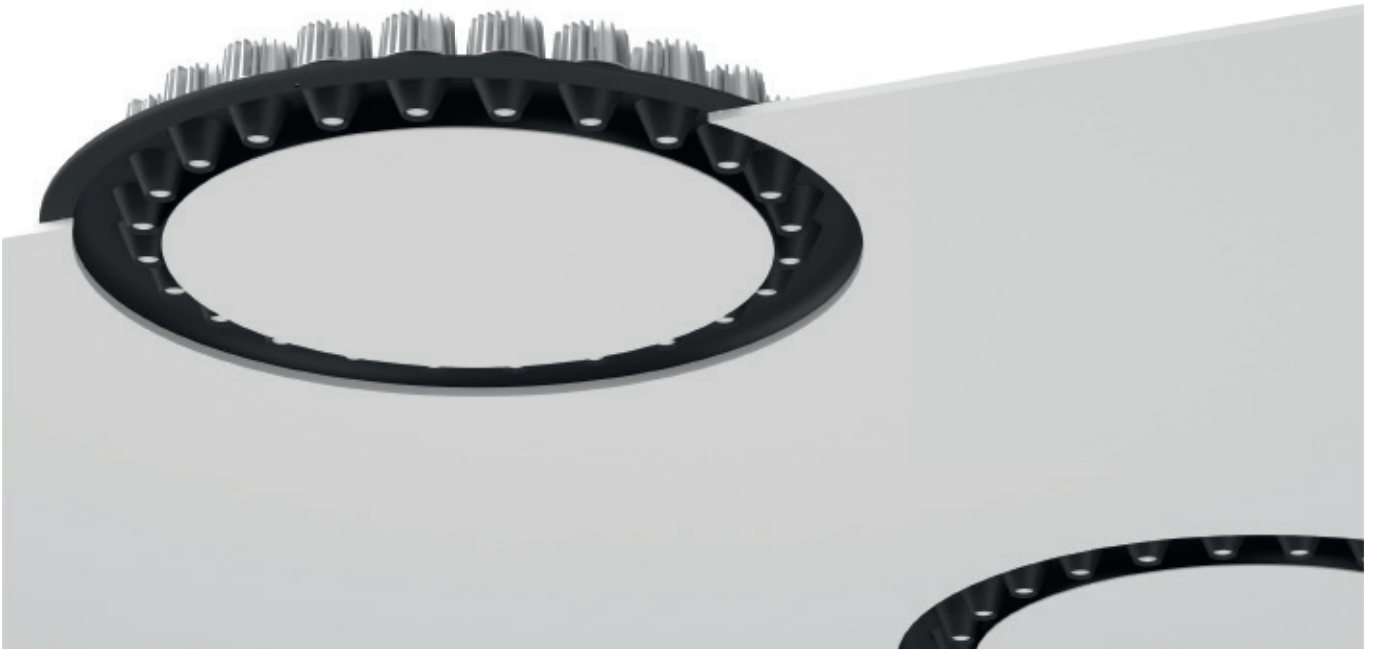

CIRCLE OF LIGHT
300 mm



LIGHT SOURCE
POWER LED
12x3W
12x325 lm
2700K/CRI 90
12x3W
12x370 lm
3000K/CRI 90

CIRCLE OF LIGHT
600 mm



LIGHT SOURCE
POWER LED
24x3W
24x325 lm
2700K/CRI 90
24x3W
24x370 lm
3000K/CRI 90

CIRCLE OF LIGHT
900 mm



LIGHT SOURCE
POWER LED
36x3W
36x325 lm
2700K/CRI 90
36x3W
36x370 lm
3000K/CRI 90

■ 14 Schwarz
14 Black



reddot design award
winner 2013

CIRCLE OF LIGHT

Produktbeschreibung

Einbauleuchte für Innenräume zur problemlosen Installation in Gipskartondecken. Die Leuchte besteht aus einer runden Struktur, auf der ein LED-Beleuchtungsmodul positioniert wird, das sich den ganzen Umkreis entlang fortsetzt.

Das Produkt wird vorinstalliert auf einem Profil vom Typ "Soft Architecture" geliefert, um einfache Montage und perfekte Integration in der Decke zu gewährleisten.

Durch das magnetische Befestigungssystem können sowohl die Installation der Lichtmodule als auch spätere Wartungsmaßnahmen ohne Spezialwerkzeuge vorgenommen werden.

Circle of Light ist in drei Durchmessern erhältlich: 300, 600 und 900 mm mit jeweils 12, 24 oder 36 Strahlern.

Reflektoren

Die Leuchte ist in der Version Akzentbeleuchtung mit intensiven Optiken (accent lighting) oder in der Version Allgemeinbeleuchtung mit extensiven Optiken (general lighting) erhältlich. Das System verfügt somit über eine gewisse Flexibilität zur Anpassung an die jeweiligen Beleuchtungsanforderungen.

Betriebsgerät

Fern-Netzteil 1050 mA eingeschlossen.

Treiber 1-10V (1V arbeitet mit 10%) für passive Controller (Sink-System). Auch kompatibel mit aktiven Dimmreglern von 0,6-10 V (Quellsystem).

Die Version 1-10V kann auch über einen einfachen Taster ohne Innenlampe gesteuert werden. Verfügbare Synchronisationskabel zwischen Treibern (für weitere Details zur Installation wenden Sie sich an die technische Abteilung).

Zusatzinformationen

Im Lieferumfang der Leuchte ist ein Fern-Netzteil 24V enthalten. Der Anschluss an den Wandler DC-DC erfolgt über ein Kabel mit Schnellanschlussklemmen, womit eine korrekte Installation gewährleistet wird und keine Spezialwerkzeuge erforderlich sind.

Der spätere Zugriff auf Netzteil und Wandler DC-DC sowie die Verbindungskabel wird dank der Möglichkeit gewährleistet, das Mittelteil der Leuchte zu entfernen. Auf diese Weise lassen sich Wartungsarbeiten einfach und problemlos durchführen.

Schutzgrad IP20.

Schutzklasse II.

Qualitätszeichen

Das Gerät entspricht der europäischen technischen Norm EN60598-1 und den entsprechenden Zusatzregelungen.

Description

A lighting system for indoor application comprised of a circular metal structure on which individual LED lighting spots are placed. The fitting is pre-wired and comes with a "Soft Architecture" type frame for an easy and seamless installation on the plasterboard ceiling.

The LED lighting modules are attached with a magnet for an easy mounting and for the maintenance no special tools are needed.

Circle of Light is available in three diameters: 300, 600 or 900 mm comprised of 12, 24 or 36 LED Lighting Spots, according to each size.

Reflectors

The LED spotlight set for the Circle of Light is available for Accent Lighting or General Lighting optic concepts. Herewith this fitting offers a some flexibility to create the desired ambiance.

Power Supply

Remote equipment 1050 mA included.

Driver 1-10V (1V means 10%) for passive dimming controls (sink system). Also compatible with active dimming controls 0,6-10V (source system).

The 1-10-V version can also be controlled a simple button without courtesy light. Cables available for synchronization between drivers (contact the technical department for more details about installation).

Additional Information

The connection of the power supply to the converter DC-DC is easy by using distribution boxes and a correct connection can be granted without any special tool. The distribution boxes are included.

For further access to the power supply and to the connected converters DC-DC during maintenance the Circle of Light has a front cover that can be easily removed and reinstalled.

IP20 protection grade.

Insulation class II.

Compliance Of Standards And Quality Marks

EN60598-1 European Technical Standards and any subsequent additions.



CIRCLE OF LIGHT

Circle Of Light 300 mm

Light Source: Power LED 12x3W - 12x325 lm - 2700K/CRI 90 / 12x3W - 12x370 lm - 3000K/CRI 90

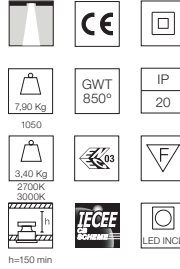
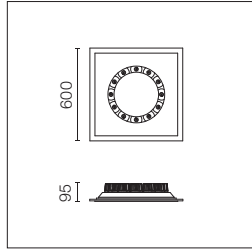

Perfekt in der Decke integriertes Beleuchtungssystem für die Aufnahme von 12 Strahlern vom Typ LED. Set aus 12 Strahlern mit dem dazugehörigen Elektrosystem nicht eingeschlossen, wird separat geliefert. Die Version 1-10V ermöglicht eine Helligkeitsregelung von 10% bis 100%.

Lighting system, seamless ceiling mounted, for 12 individual LED lighting spots. Set of 12 spots, complete with junction box, power supply and cables, has to be ordered separately. The 1-10V version is dimmable from 10% to 100%.

Akzent- und Allgemeines Beleuchtung: man muss 1 Stück bestellen.

Accent lighting and general lighting: 1 unit must be ordered.

For Casambi versions consult the Front Office.

Für Casambi-Versionen wenden Sie sich an das Front Office.

Ø300

Soft Plate
SA.1050.1

2700K

Set of 12 spots
Accent Lighting
08.8662.14C
08.8662.14C1V
08.8662.14CDA

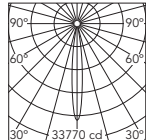

Beam Angle: 12°

h(m)	E(lx)	D(m)
1	33770	0.22
2	8442	0.43
3	3752	0.65
4	2111	0.87
5	1351	1.08

Luminous flux luminaire
1890 lm

3000K

Set of 12 spots
Accent Lighting
08.8572.14C
08.8572.14C1V
08.8572.14CDA

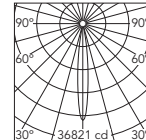

Beam Angle: 12°

h(m)	E(lx)	D(m)
1	36821	0.22
2	9205	0.43
3	4091	0.65
4	2301	0.87
5	1473	1.08

Luminous flux luminaire
2061 lm

2700K

Set of 12 spots
General Lighting
08.8663.14C
08.8663.14C1V
08.8663.14CDA

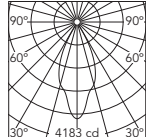

Beam Angle: 44°

h(m)	E(lx)	D(m)
1	4183	0.81
2	1046	1.61
3	465	2.42
4	261	3.23
5	167	4.03

Luminous flux luminaire
2011 lm

3000K

Set of 12 spots
General Lighting
08.8573.14C
08.8573.14C1V
08.8573.14CDA

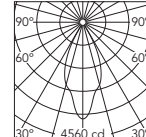

Beam Angle: 44°

h(m)	E(lx)	D(m)
1	4560	0.81
2	1140	1.61
3	507	2.42
4	285	3.23
5	182	4.03

Luminous flux luminaire
2193 lm

Circle Of Light 600 mm

Light Source: Power LED 24x3W - 24x325 lm - 2700K/CRI 90 / 24x3W - 24x370 lm - 3000K/CRI 90

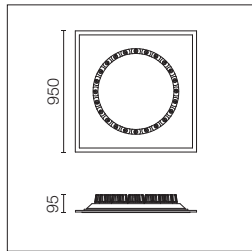

Perfekt in der Decke integriertes Beleuchtungssystem für die Aufnahme von 24 Strahlern vom Typ LED. Sets aus 12 Strahlern mit den dazugehörigen Elektrosystemen nicht eingeschlossen, werden separat geliefert. Die Version 1-10V ermöglicht eine Helligkeitsregelung von 10% bis 100%.

Lighting system, seamless ceiling mounted, for 24 individual LED lighting spots. Set of 12 spots, complete with junction box, power supply and cables, has to be ordered separately. The 1-10V version is dimmable from 10% to 100%.

Akzent- und Allgemeines Beleuchtung: man muss 2 Stück bestellen.

Accent lighting and general lighting: 2 units must be ordered.

For Casambi versions consult the Front Office.

Für Casambi-Versionen wenden Sie sich an das Front Office.

Ø600

Soft Plate
SA.1051.1

2700K

Set of 12 spots
Accent Lighting
08.8662.14C
08.8662.14C1V
08.8662.14CDA

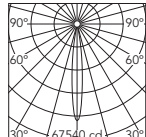

Beam Angle: 12°

h(m)	E(lx)	D(m)
1	67540	0.22
2	16885	0.43
3	7504	0.65
4	4221	0.87
5	2702	1.08

Luminous flux luminaire
3781 lm

3000K

Set of 12 spots
Accent Lighting
08.8572.14C
08.8572.14C1V
08.8572.14CDA

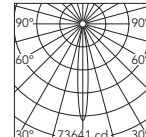

Beam Angle: 12°

h(m)	E(lx)	D(m)
1	73641	0.22
2	18410	0.43
3	8182	0.65
4	4603	0.87
5	2946	1.08

Luminous flux luminaire
4122 lm

2700K

Set of 12 spots
General Lighting
08.8663.14C
08.8663.14C1V
08.8663.14CDA

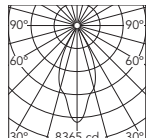

Beam Angle: 44°

h(m)	E(lx)	D(m)
1	8365	0.81
2	2091	1.61
3	929	2.42
4	523	3.23
5	335	4.03

Luminous flux luminaire
4023 lm

3000K

Set of 12 spots
General Lighting
08.8573.14C
08.8573.14C1V
08.8573.14CDA

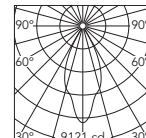

Beam Angle: 44°

h(m)	E(lx)	D(m)
1	9121	0.81
2	2280	1.61
3	1013	2.42
4	570	3.23
5	365	4.03

Luminous flux luminaire
4386 lm

CIRCLE OF LIGHT

Circle Of Light 900 mm

Light Source: Power LED 36x3W - 36x325 lm - 2700K/CRI 90 / 36x3W - 36x370 lm - 3000K/CRI 90

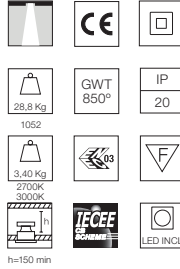
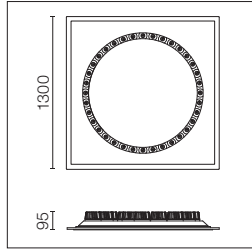

Perfekt in der Decke integriertes Beleuchtungssystem für die Aufnahme von 36 Strahlern vom Typ LED. Sets aus 12 Strahlern mit den dazugehörigen Elektrosystemen nicht eingeschlossen, werden separat geliefert. Die Version 1-10V ermöglicht eine Helligkeitsregelung von 10% bis 100%.

Lighting system, seamless ceiling mounted, for 36 individual LED lighting spots. Set of 12 spots, complete with junction box, power supply and cables, has to be ordered separately. The 1-10V version is dimmable from 10% to 100%.

Akzent- und Allgemeines Beleuchtung: man muss 3 Stück bestellen.

Accent lighting and general lighting: 3 units must be ordered.

Ø900

Soft Plate

SA.1052.1

2700K

Set of 12 spots
Accent Lighting

08.8662.14C
08.8662.14C1V
08.8662.14CDA

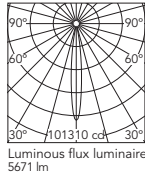

Beam Angle: 12°		
h(m)	E(lx)	D(m)
1	101310	0.22
2	25327	0.43
3	11257	0.65
4	6332	0.87
5	4052	1.08

Luminous flux luminaire
5671 lm

3000K

Set of 12 spots
Accent Lighting

08.8572.14C
08.8572.14C1V
08.8572.14CDA

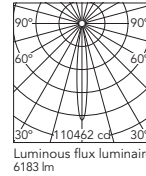

Beam Angle: 12°		
h(m)	E(lx)	D(m)
1	110462	0.22
2	27616	0.43
3	12274	0.65
4	6904	0.87
5	4418	1.08

Luminous flux luminaire
6183 lm

2700K

Set of 12 spots
General Lighting

08.8663.14C
08.8663.14C1V
08.8663.14CDA

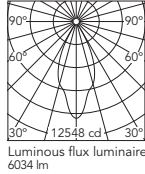

Beam Angle: 44°		
h(m)	E(lx)	D(m)
1	12548	0.81
2	3137	1.61
3	1394	2.42
4	784	3.23
5	502	4.03

Luminous flux luminaire
6034 lm

3000K

Set of 12 spots
General Lighting

08.8573.14C
08.8573.14C1V
08.8573.14CDA

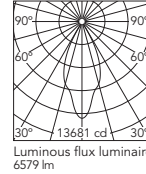

Beam Angle: 44°		
h(m)	E(lx)	D(m)
1	13681	0.81
2	3420	1.61
3	1520	2.42
4	855	3.23
5	547	4.03

Luminous flux luminaire
6579 lm

LED CURTAIN

DESIGNED BY FLOS ARCHITECTURAL

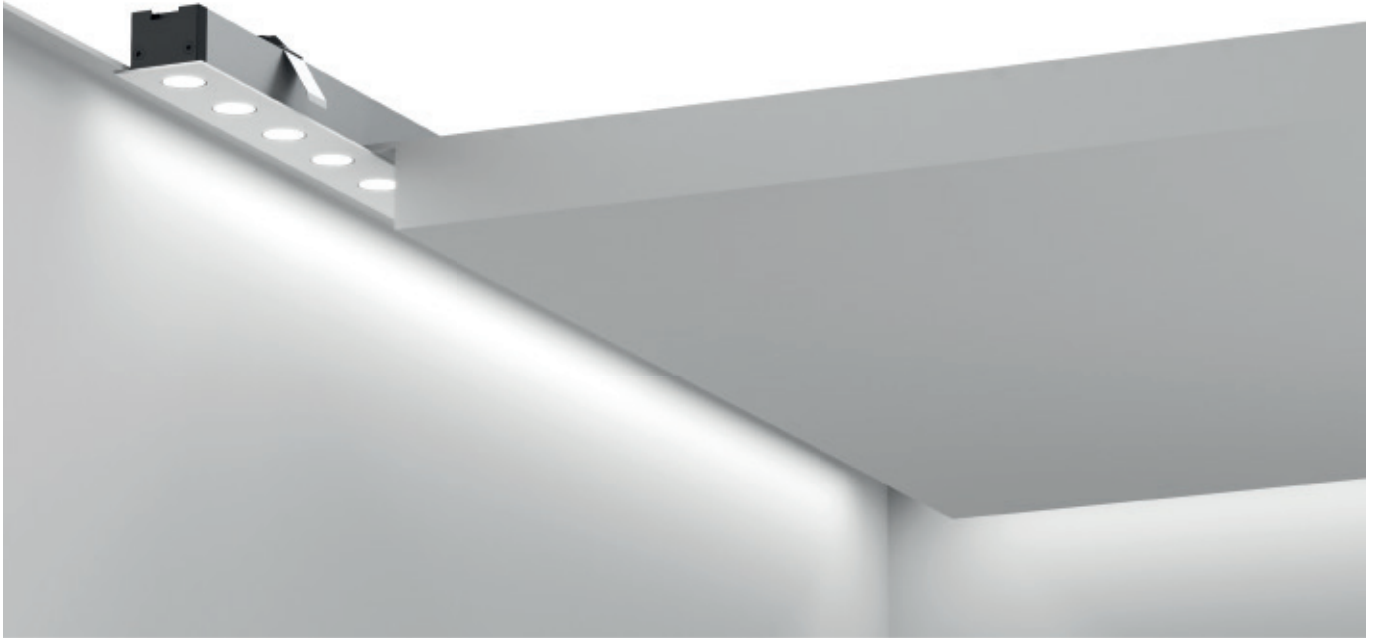

LIGHT SOURCE

POWER LED
29W/m
24V
3500 lm/m
3000K/CRI 90
4000K/CRI 90

- 30 Weiss
- 30 White



LED CURTAIN

Produktbeschreibung

Einbauleuchte für LED-Lichtquelle. Sie besteht aus zwei stranggepressten Aluminiumprofilen, die den Hochleistungs-LEDs als Kühlelement dienen. Ellipsenförmige Linsen sorgen für eine perfekte Lichtstreuung.
Verfügbar in Modulen in unterschiedlichen Längen, die über ein Verbundkabel mit Schnellanschluss vom Typ Tyco miteinander verbunden werden können.

Betriebsgerät

24-V-Netzgeräte erhältlich für 20W bis 100W Leistung (max. Länge 3 meter). Dimmer-Systeme mit 1-10V oder Dali verfügbar.

Zusatzinformationen

LED-Module verschiedener Längen, die untereinander über das als Zubehör erhältliche Verbundkabel zu verbinden sind. Verfügen über Schnellanschlüsse vom Typ Tyco, weshalb die Stromversorgung über das vorgesehene Zubehörkabel zu erfolgen hat.
Die maximale Länge ab dem Versorgungspunkt beträgt 3 Meter.
Schutzgrad IP20.
Schutzklasse III.

Qualitätszeichen

Das Gerät entspricht der europäischen technischen Norm EN60598-1 und den entsprechenden Zusatzregelungen.

Description

Embedded light fixtures for LED light source. Made of two extruded aluminium sections used to dissipate the heat from the power LEDs.
With elliptical lenses for perfect light distribution.
Available in modules of different lengths which can be interconnected by a Tyco-type fast-connection cable.

Power Supply

24V power supplies available with a power of between 20W and 100W (maximum 3 metres in length).
Control system with 1-10V dimmer or Dali available.

Additional Information

LED modules of different lengths, inter-connectable using the connection cable. With fast Tyco-type connectors, for power supply with the cable provided for this purpose, available with accessories. Maximum length from a connection point 3 metres.
IP20 protection grade.
Insulation class III.

Standard Compliance and Quality Marks

EN60598-1 European Technical Standards and any subsequent additions.



LED CURTAIN

LED Curtain

Light Source: Power LED 29W/m - 24V - 3500 lm/m - 3000K/CRI 90 / 29W/m - 24V - 3500 lm/m - 4000K/CRI 90

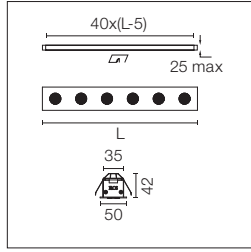

Einbauleuchte für direkte LED Beleuchtung. Inklusive ellipsenförmige Linse 12°x52°. Fern-Driver ist nicht eingeschlossen.

Recessed luminaire for direct lighting with LED. Elliptical lens 12°x52° incorporated. Remote transformer not included.

3000K

L: 600 mm
17,3W - 2000 lm - 12 LEDs

03.3902.30C

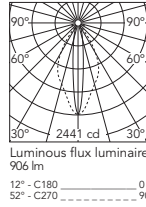

Beam Angle: 12°

h(m)	E(lx)	D(m)
1	2441	0.23
2	610	0.46
3	271	0.69
4	153	0.92
5	98	1.15

4000K

L: 600 mm
17,3W - 2100 lm - 12 LEDs

03.3922.30C

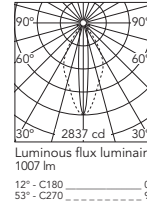

Beam Angle: 12°

h(m)	E(lx)	D(m)
1	2837	0.21
2	709	0.42
3	315	0.63
4	177	0.84
5	113	1.06

L: 900 mm
26W - 3000 lm - 18 LEDs

03.3903.30C

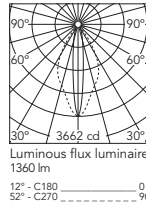

Beam Angle: 12°

h(m)	E(lx)	D(m)
1	3662	0.23
2	916	0.46
3	407	0.69
4	229	0.92
5	146	1.15

L: 900 mm
26W - 3150 lm - 18 LEDs

03.3923.30C

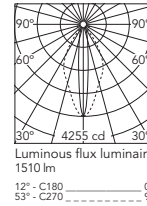

Beam Angle: 12°

h(m)	E(lx)	D(m)
1	4255	0.21
2	1064	0.42
3	473	0.63
4	266	0.84
5	170	1.06

L: 1200 mm
34,7W - 4000 lm - 24 LEDs

03.3904.30C

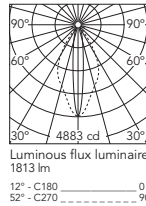

Beam Angle: 12°

h(m)	E(lx)	D(m)
1	4883	0.23
2	1221	0.46
3	543	0.69
4	305	0.92
5	195	1.15

L: 1200 mm
34,7W - 4200 lm - 24 LEDs

03.3924.30C

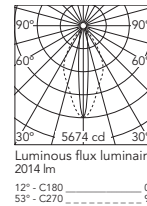

Beam Angle: 12°

h(m)	E(lx)	D(m)
1	5674	0.21
2	1418	0.42
3	630	0.63
4	355	0.84
5	227	1.06

LED CURTAIN

Treiber / Drivers

Elektronischer Transformator für LED mit beständiger Spannung (24V) – 100/240V.

Electronic transformer with constant voltage (24V) for LED. 100/240V.

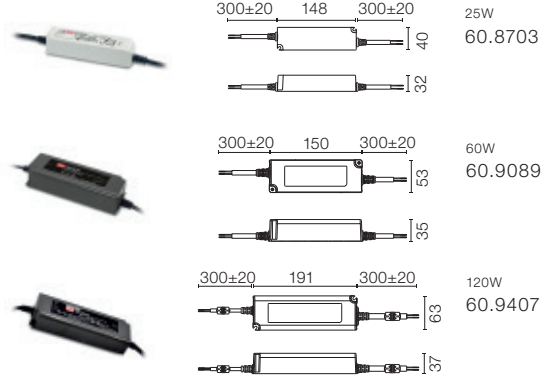

Elektronischer Transformator für LED mit beständiger Spannung (24V) – 60W. 100/240V. Für unabhängige Verwendung.

Electronic transformer with constant voltage (24V) for LED. 60W. 100/240V. For independent use.

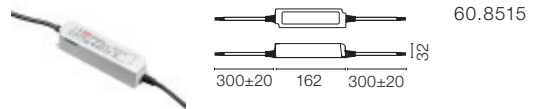

Steuereinheit für 1-10V-Dimmung; 1-Kanal-Steuerung für 24V-LED-Module; Netzgerät nicht inbegriffen. Max. 120W - 5A.

Dimmable 1-10V control unit with 1 channel for 24V LED modules. Power supply not included. Max. 120W - 5A.

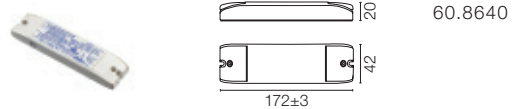

Steuereinheit für DALI-Dimmung; 3-Kanal-Steuerung für 24V-LED-Module; Netzgerät nicht inbegriffen. Max. 120W - 5A.

Dimmable DALI control unit with 3 channel for 24V LED modules. Power supply not included. Max. 120W - 5A.

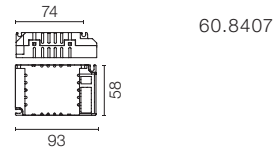

Verbundkabel für Module mit Schnellanschluss Typ Tyco.

Connection cable between modules with Tyco fast connection cable.



Netzkabel mit Schnellanschluss Typ Tyco. Maximale Netzkabellänge 3 meter.

Power cable with Tyco fast connection cable. Maximum supply length 3 metres.



DOWNLIGHTS

Kap, Bon Jour, Light Shooter,
Light Sniper, UT Downlight, Light Supply,
Pure Downlight, Compass, Anthony Downlight,
Wan Downlight, Johnny, Compass Box Recessed,
Battery, Micro Battery.

KAP

DESIGNED BY FLOS ARCHITECTURAL

KAP Ø50
FIXED



KAP Ø50
ADJUSTABLE



LIGHT SOURCE
LED ARRAY
7,5W
595 lm
2700K/CRI 90
635 lm
3000K/CRI 90

KAP 80/
KAP 80 PLUS
FIXED



KAP 80/
KAP 80 PLUS
WALL-WASHER



KAP 80/
KAP 80 PLUS
ADJUSTABLE



LIGHT SOURCE
LED ARRAY
max 13W
1370 lm
2700K/CRI 90
1460 lm
3000K/CRI 90

LIGHT SOURCE
LED ARRAY
13W
1800K-2850K
CRI 95
Dim To Warm*
*Only for KAP 80

LIGHT SOURCE
LED
QR-CBC 51
GX5.3

LIGHT SOURCE
LED
PAR 16
GZ10

LIGHT SOURCE
LED ARRAY
max 13W
1370 lm
2700K/CRI 90
1460 lm
3000K/CRI 90

LIGHT SOURCE
LED ARRAY
13W
1800K-2850K
CRI 95
Dim To Warm*
*Only for KAP 80

LIGHT SOURCE
LED
QR-CBC 51
GX5.3

LIGHT SOURCE
LED
PAR 16
GZ10

KAP Ø105
FIXED



KAP Ø105
WALL-WASHER



KAP Ø105
ADJUSTABLE



KAP Ø105
DEEP



KAP 105
SQUARE
FIXED



LIGHT SOURCE
LED ARRAY
23W
2690 lm
2700K/CRI 90
2870 lm
3000K/CRI 90

LIGHT SOURCE
LED
QR-CBC 51
GX5.3

LED
PAR 16
GZ10

LIGHT SOURCE
LED
QR-CBC 51
GX5.3

LIGHT SOURCE
LED ARRAY
23W
2690 lm
2700K/CRI 90
2870 lm
3000K/CRI 90

LIGHT SOURCE
PHOSPHOR
LED
17W
1400 lm
2700K/CRI 98
3000K/CRI 98

LIGHT SOURCE
LED ARRAY
17W
1800 lm
2700K/CRI 90
2000 lm
3000K/CRI 90

LIGHT SOURCE
LED
QR-CBC 51
GX5.3

LED
PAR 16
GZ10

KAP Ø145
FIXED



KAP Ø145
WALL-WASHER



KAP Ø145
DEEP



LIGHT SOURCE
PHOSPHOR
LED
17W
1400 lm
2700K/CRI 98
3000K/CRI 98

LIGHT SOURCE
LED ARRAY
17W
1800 lm
2700K/CRI 90
2000 lm
3000K/CRI 90

KAP

EASY KAP Ø50
FIXED



EASY KAP Ø50
ADJUSTABLE



LIGHT SOURCE
LED ARRAY
7,5W
595 lm
2700K/CRI 90
635 lm
3000K/CRI 90

EASY KAP 80/
EASY KAP 80 PLUS
FIXED



LIGHT SOURCE
LED ARRAY
max 13W
1370 lm
2700K/CRI 90
1460 lm
3000K/CRI 90

EASY KAP 80/
EASY KAP 80 PLUS
WALL-WASHER



LIGHT SOURCE
LED ARRAY
13W
1800K-2850K
CRI 95
Dim To Warm*
*Only for KAP 80

EASY KAP 80/
EASY KAP 80
PLUS ADJUSTABLE



LIGHT SOURCE
LED
QR-CBC 51
GX5.3

LIGHT SOURCE
LED
PAR 16
GZ10

EASY KAP Ø105
FIXED



LIGHT SOURCE
LED ARRAY
23W
2690 lm
2700K/CRI 90
2870 lm
3000K/CRI 90

EASY KAP Ø105
WALL-WASHER



LIGHT SOURCE
LED
QR-CBC 51
GX5.3

EASY KAP Ø105
ADJUSTABLE



LIGHT SOURCE
LED
PAR 16
GZ10

□ B1 Weiss
B1 White



■ GL Mattgold
GL Matt Gold



■ BU Blau
BU Blue



■ 74 Schwarz
74 Black



■ CU Kupfer
CU Copper



Produktbeschreibung

Deckeneinbauleuchte für Halogenlampen, Halogen-Metallampfen und LEDs.

Die Version Easy Kap hat einen Körper aus gespritztem Aluminium für die Versionen 50, 80 und 105 mm, mit einer Flüssiglack-, Staub- und/oder Metallkupferlackierung mit einem Diffusor aus Glas oder Kunststoff, je nach Version. Kein Vorinstallationsrahmen erforderlich.

Das Modell Kap besitzt ein Gehäuse aus Aluminium-Spritzguss mit Nasslack-Finish und Kupferbeschichtung. Erhältlich in drei Durchmesser: 50 mm, 80 mm, 105 mm und 145 mm.

Ausführung je nach Version in glänzendem, eloxiertem Aluminium mit Diffusorelement aus Glas oder Kunststoff. Lampenfassung mit Kühlkörper aus Aluminium-Spritzguss und Einbauring für das optische Gehäuse aus thermoplastischem Material.

Einspeisung

Easy Kap 50/80/105 LED und Kap 50 und 80: Fernsteuerung nicht inbegriffen.

Kap 105/145 LED/Kap 80 und Easy Kap 80 Dim To Warm: 1-10V Fernsteuerung inbegriffen. Die Ausgangsspannung des Geräts muss immer unter 60 VDC liegen.

Zubehör

Vorinstallationsrahmen für die Modelle Kap 50 und 80 round und square, und Kap 105 round.

Deckendose für die Installation auf Zement erhältlich.

Zusatzinformationen

Schutzgrad IP20, IP23, IP43, IP44, IP54 je nach Modell. Schutzklasse I, II, III je nach Modell.

- KAP 50 / 80 / 105 / 145:

Die LED-Module mit Phosphor-LED erreichen dank der Remote-Phosphor-Technologie je nach Modell einen Farbwiedergabeindex von bis zu 98 und bieten die bestmögliche Lichtqualität und Wahrnehmung von Gegenständen und Raum.

Die LED-Module der Modellreihe LED Array entsprechen dem neuesten Stand der Technik, der sich durch eine geringere Durchschnittstemperatur im elektronischen Betrieb auszeichnet. Dank dieser Eigenschaft kann die Lichtquelle, innerhalb der Sicherheitsparameter, mit einer höheren Leistung betrieben werden und einen 20 % größeren Lichtstrom erzeugen.

Die neue "Dim To Warm" -Technologie reproduziert die Wirkung der alten Halogenlampen durch Regelung und bietet durch Verringern der Lichtintensität mehr Wärme. "Dim To Warm" -Leuchten werden durch das 1-10V-Protokoll geregelt.

Qualitätszeichen

Das Gerät entspricht der europäischen technischen Norm EN60598-1 und den entsprechenden Zusatzregelungen.

Description

Luminaire for embedded installation in ceilings for LEDs lamps.

The Easy Kap version has an aluminium injected body for the 50, 80 and 105 mm versions, with a liquid paint, dust and/or metallic copper finish with a glass or plastic diffuser depending on the version. It does not need a pre-installation frame.

The Kap version has an aluminium-injected body with a liquid paint and metallic copper finish. Available in three diameters: 50 mm, 80 mm, 105 mm and 145 mm. Main optics in shiny anodised aluminium with a glass or plastic diffuser element, depending on the version.

Lamp holder with a dissipating element in injected aluminium and a thermoplastic embedding ring for the optic body.

Power Supply

Easy Kap 50/80/105 LED and Kap 50 and 80: Remote equipment not included.

Kap 105/145 LED/Kap 80 and Easy Kap 80 Dim To Warm: 1-10V remote equipment included. The output voltage of the equipment must always be less than 60Vdc.

Accessories

Pre-installation frame for the round and square Kap 50 and 80 and 105 version.

Available for installation on cement.

Additional Information

IP20, IP23, IP43, IP44, IP54 protection grade depending on the versions.

Insulation class I, II, III depending on the versions.

- KAP 50 / 80 / 105 / 145:

Thanks to remote-phosphor technology, the LED modules of the Phosphor LED version offer maximum quality light, the perception of objects and spaces, reaching chromatic reproduction indices of 98, depending on the version.

The LED modules installed on the LED Array versions have cutting-edge technology that permits a lower average temperature in the electronics. Thanks to this feature, the luminaire can operate at a higher power inside the safety parameters yet still offer 20% added luminous flux.

The new "Dim To Warm" technology reproduces the effect of a traditional lamp, offering a warmer light by reducing the light intensity.

The "Dim To Warm" luminaries are dimmed through the 1-10V protocol.

Standard Compliance and Quality Marks

EN60598-1 European Technical Standards and any subsequent additions.



Easy Kap



Kap

KAP

Kap Ø50 Fixed - Optic Spot

Light Source: LED Array DC 200 mA - 7,5W - 595 lm - 2700K/CRI 90 / 7,5W - 635 lm - 3000K/CRI 90

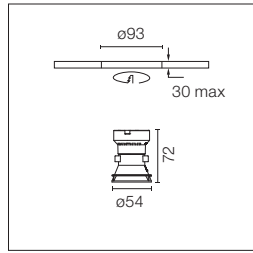

LED Einbauleuchte. Ohne Netzgerät. Remote-Netzteil zur Anbringung an einer zugänglichen Stelle. Vorinstallationsrahmen. Muss separat bestellt werden.

Recessed luminaire with LED light source. Power supply not included. Remote power supply to be installed in an accessible place. Pre-installation frame. To be ordered separately.

Empfohlene Netzgeräte / Recommended power supply*:

- Non Dimmable 60.9160
- Dimmable 0-10V 60.9483
- Dimmable DALI 2 60.9604
- Mains Dimming 60.9421
- Casambi 60.9392 + DALI/1-10V Driver

* Siehe Treiberkapitel / Refer to the Drivers chapter

2700K
□ 05.7300.B1

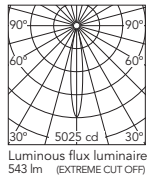

Beam Angle: 15°

h(m)	E(lx)	D(m)
1	5025	0.27
2	1256	0.53
3	558	0.80
4	314	1.07
5	201	1.33

Luminous flux luminaire 543 lm (EXTREME CUT OFF)

3000K
□ 05.7305.B1

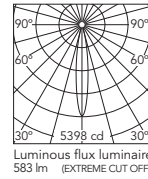

Beam Angle: 15°

h(m)	E(lx)	D(m)
1	5398	0.27
2	1349	0.53
3	600	0.80
4	337	1.07
5	216	1.33

Luminous flux luminaire 583 lm (EXTREME CUT OFF)

■ 05.7300.GL

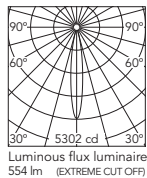

Beam Angle: 15°

h(m)	E(lx)	D(m)
1	5302	0.26
2	1325	0.53
3	589	0.79
4	331	1.06
5	212	1.32

Luminous flux luminaire 554 lm (EXTREME CUT OFF)

■ 05.7305.GL

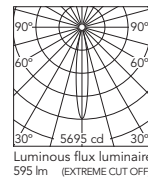

Beam Angle: 15°

h(m)	E(lx)	D(m)
1	5695	0.26
2	1424	0.53
3	633	0.79
4	356	1.06
5	228	1.32

Luminous flux luminaire 595 lm (EXTREME CUT OFF)

■ 05.7300.BU

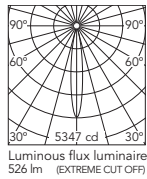

Beam Angle: 15°

h(m)	E(lx)	D(m)
1	5347	0.26
2	1337	0.52
3	594	0.78
4	334	1.04
5	214	1.30

Luminous flux luminaire 526 lm (EXTREME CUT OFF)

■ 05.7305.BU

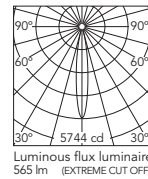

Beam Angle: 15°

h(m)	E(lx)	D(m)
1	5744	0.26
2	1436	0.52
3	638	0.78
4	359	1.04
5	230	1.30

Luminous flux luminaire 565 lm (EXTREME CUT OFF)

■ 05.7300.74

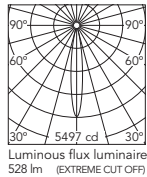

Beam Angle: 15°

h(m)	E(lx)	D(m)
1	5497	0.26
2	1374	0.52
3	611	0.77
4	344	1.03
5	220	1.29

Luminous flux luminaire 528 lm (EXTREME CUT OFF)

■ 05.7305.74

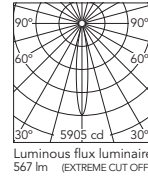

Beam Angle: 15°

h(m)	E(lx)	D(m)
1	5905	0.26
2	1476	0.52
3	656	0.77
4	369	1.03
5	236	1.29

Luminous flux luminaire 567 lm (EXTREME CUT OFF)

■ 05.7300.CU

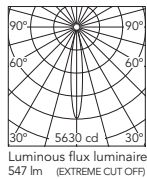

Beam Angle: 15°

h(m)	E(lx)	D(m)
1	5630	0.26
2	1408	0.51
3	626	0.77
4	352	1.03
5	225	1.29

Luminous flux luminaire 547 lm (EXTREME CUT OFF)

■ 05.7305.CU

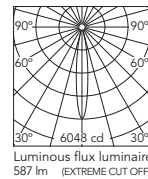

Beam Angle: 15°

h(m)	E(lx)	D(m)
1	6048	0.26
2	1512	0.51
3	672	0.77
4	378	1.03
5	242	1.29

Luminous flux luminaire 587 lm (EXTREME CUT OFF)

KAP

Kap Ø50 Fixed - Optic Medium

Light Source: LED Array DC 200 mA - 7,5W - 595 lm - 2700K/CRI 90 / 7,5W - 635 lm - 3000K/CRI 90

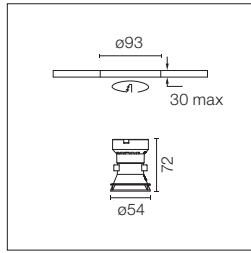

LED Einbauleuchte. Ohne Netzgerät. Remote-Netzteil zur Anbringung an einer zugänglichen Stelle. Vorinstallationsrahmen. Muss separat bestellt werden.

Recessed luminaire with LED light source. Power supply not included. Remote power supply to be installed in an accessible place. Pre-installation frame. To be ordered separately.

Empfohlene Netzgeräte / Recommended power supply*:

Non Dimmable	60.9160
Dimmable 0-10V	60.9483
Dimmable DALI 2	60.9604
Mains Dimming	60.9421
Casambi	60.9392 + DALI/1-10V Driver

* Siehe Treiberkapitel / Refer to the Drivers chapter

2700K
□ 05.7301.B1

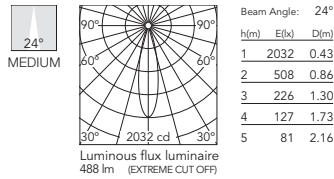

3000K
□ 05.7306.B1

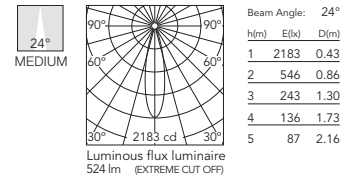

■ 05.7301.GL

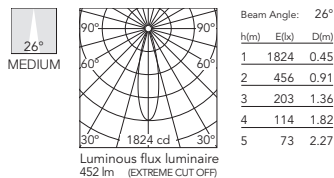

■ 05.7306.GL

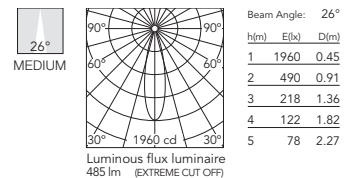

■ 05.7301.BU

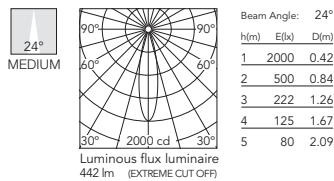

■ 05.7306.BU

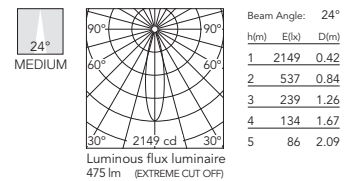

■ 05.7301.74

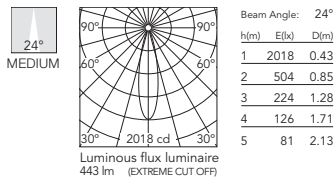

■ 05.7306.74

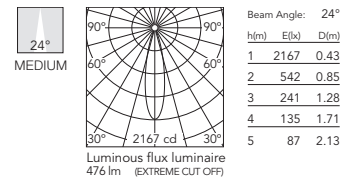

■ 05.7301.CU

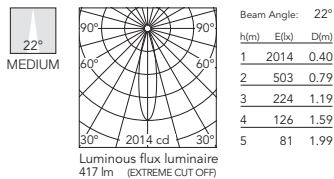

■ 05.7306.CU

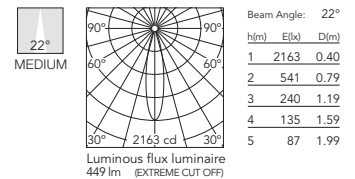

KAP

Kap Ø50 Fixed - Optic Flood

Light Source: LED Array DC 200 mA - 7,5W - 595 lm - 2700K/CRI 90 / 7,5W - 635 lm - 3000K/CRI 90

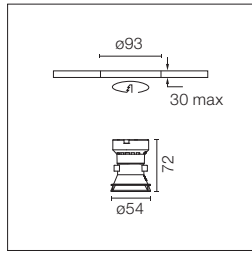

LED Einbauleuchte. Ohne Netzgerät. Remote-Netzteil zur Anbringung an einer zugänglichen Stelle. Vorinstallationsrahmen. Muss separat bestellt werden.

Recessed luminaire with LED light source. Power supply not included. Remote power supply to be installed in an accessible place. Pre-installation frame. To be ordered separately.

Empfohlene Netzgeräte / Recommended power supply*:

- Non Dimmable 60.9160
- Dimmable 0-10V 60.9483
- Dimmable Dali 60.9604
- Mains Dimming 60.9421
- Casambi 60.9392 + DALI/1-10V Driver

* Siehe Treiberkapitel / Refer to the Drivers chapter

2700K
□ 05.7302.B1

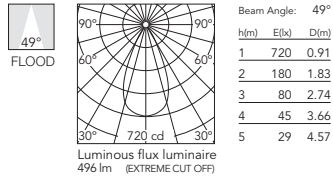

3000K
□ 05.7307.B1

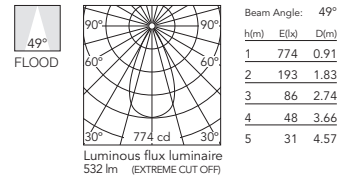

■ 05.7302.GL

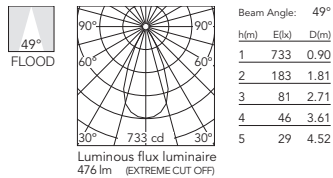

■ 05.7307.GL

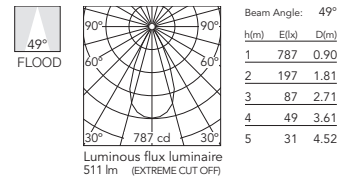

■ 05.7302.BU

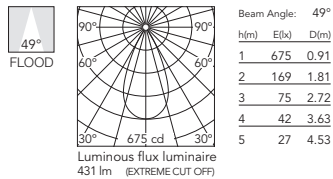

■ 05.7307.BU

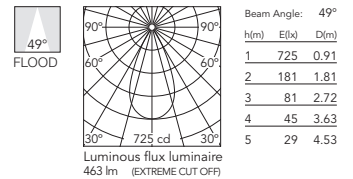

■ 05.7302.74

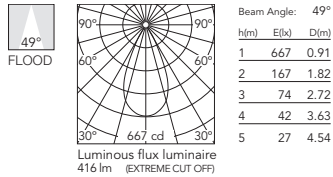

■ 05.7307.74

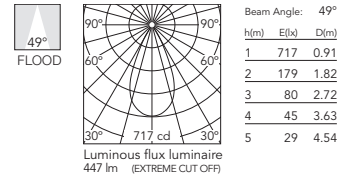

■ 05.7302.CU

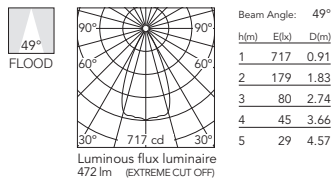

■ 05.7307.CU

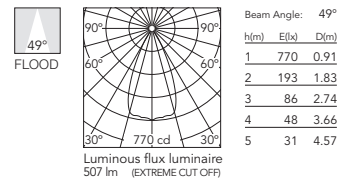

KAP

Kap Ø50 Adjustable - Optic Spot

Light Source: LED Array DC 200 mA - 7,5W - 595 lm - 2700K/CRI 90 / 7,5W - 635 lm - 3000K/CRI 90

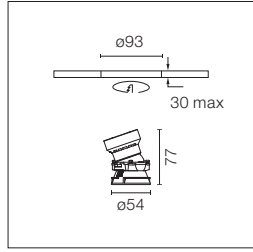

LED Einbauleuchte. Ohne Netzgerät. Remote-Netzteil zur Anbringung an einer zugänglichen Stelle. Vorinstallationsrahmen. Muss separat bestellt werden.

Recessed luminaire with LED light source. Power supply not included. Remote power supply to be installed in an accessible place. Pre-installation frame. To be ordered separately.

Empfohlene Netzgeräte / Recommended power supply*:

Non Dimmable	60.9160
Dimmable 0-10V	60.9483
Dimmable Dali	60.9604
Mains Dimming	60.9421
Casambi	60.9392 + DALI/1-10V Driver

* Siehe Treiberkapitel / Refer to the Drivers chapter

2700K
□ 05.7310.B1

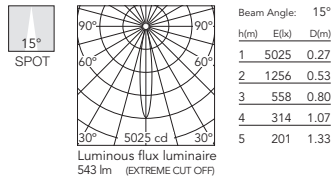

3000K
□ 05.7315.B1

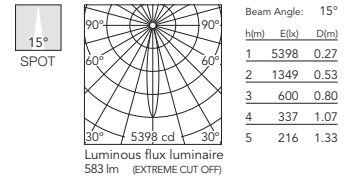

■ 05.7310.GL

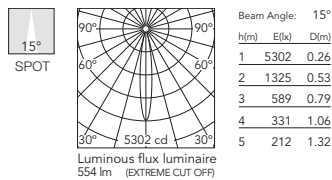

■ 05.7315.GL

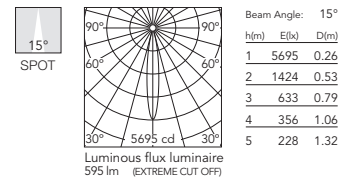

■ 05.7310.BU

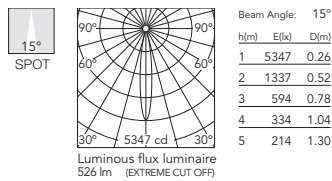

■ 05.7315.BU

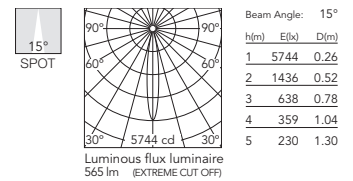

■ 05.7310.74

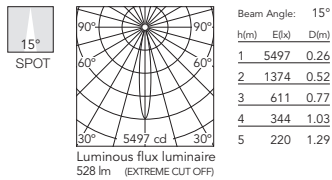

■ 05.7315.74

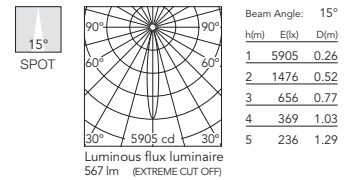

■ 05.7310.CU

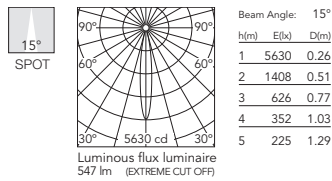

■ 05.7315.CU

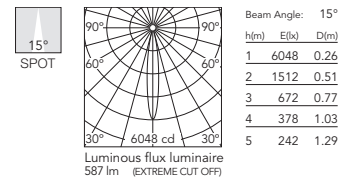

KAP

Kap Ø50 Adjustable - Optic Medium

Light Source: LED Array DC 200 mA - 7,5W - 595 lm - 2700K/CRI 90 / 7,5W - 635 lm - 3000K/CRI 90

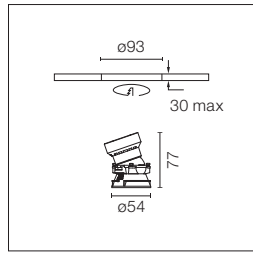

LED Einbauleuchte. Ohne Netzgerät. Remote-Netzteil zur Anbringung an einer zugänglichen Stelle. Vorinstallationsrahmen. Muss separat bestellt werden.

Recessed luminaire with LED light source. Power supply not included. Remote power supply to be installed in an accessible place. Pre-installation frame. To be ordered separately.

Empfohlene Netzgeräte / Recommended power supply*:

Non Dimmable	60.9160
Dimmable 0-10V	60.9483
Dimmable Dali	60.9604
Mains Dimming	60.9421
Casambi	60.9392 + DALI/1-10V Driver

* Siehe Treiberkapitel / Refer to the Drivers chapter

2700K
□ 05.7311.B1

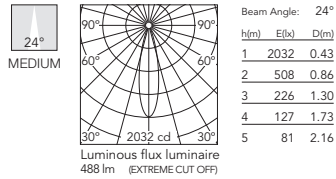

3000K
□ 05.7316.B1

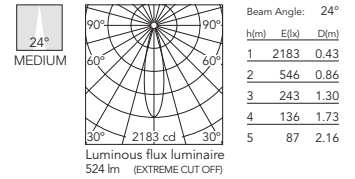

■ 05.7311.GL

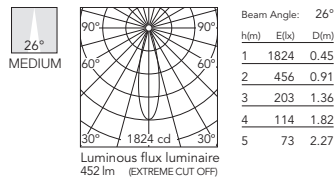

■ 05.7316.GL

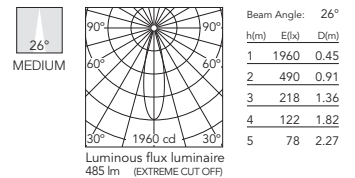

■ 05.7311.BU

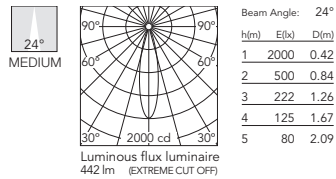

■ 05.7316.BU

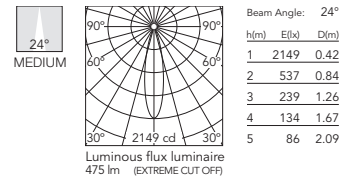

■ 05.7311.74

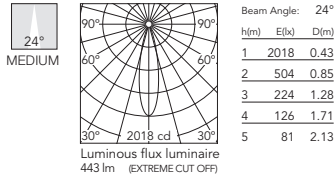

■ 05.7316.74

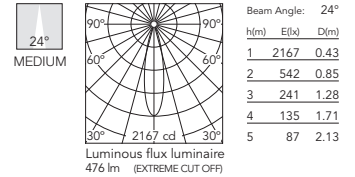

■ 05.7311.CU

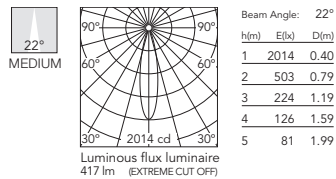

■ 05.7316.CU

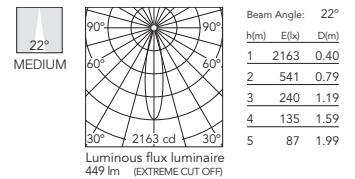

KAP

Kap Ø50 Adjustable - Optic Flood

Light Source: LED Array DC 200 mA - 7,5W - 595 lm - 2700K/CRI 90 / 7,5W - 635 lm - 3000K/CRI 90

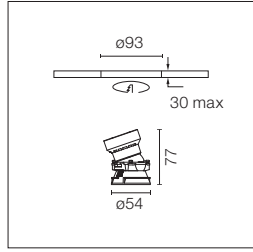

LED Einbauleuchte. Ohne Netzgerät. Remote-Netzteil zur Anbringung an einer zugänglichen Stelle. Vorinstallationsrahmen. Muss separat bestellt werden.

Recessed luminaire with LED light source. Power supply not included. Remote power supply to be installed in an accessible place. Pre-installation frame. To be ordered separately.

Empfohlene Netzgeräte / Recommended power supply*:

- Non Dimmable 60.9160
- Dimmable 0-10V 60.9483
- Dimmable Dali 60.9604
- Mains Dimming 60.9421
- Casambi 60.9392 + DALI/1-10V Driver

* Siehe Treiberkapitel / Refer to the Drivers chapter

2700K
□ 05.7312.B1

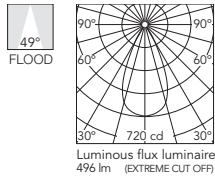

3000K
□ 05.7317.B1

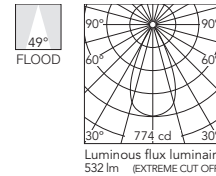

■ 05.7312.GL

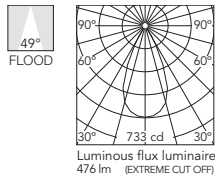

■ 05.7317.GL

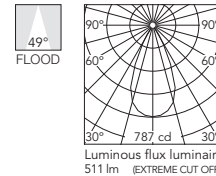

■ 05.7312.BU

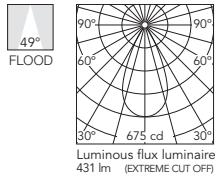

■ 05.7317.BU

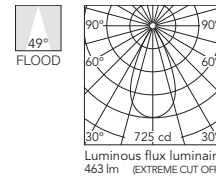

■ 05.7312.74

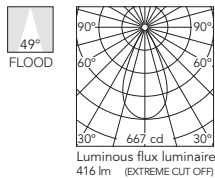

■ 05.7317.74

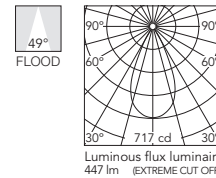

■ 05.7312.CU

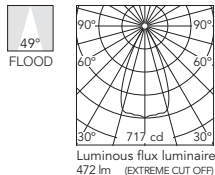

■ 05.7317.CU

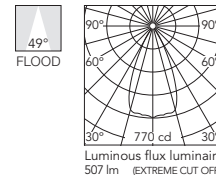

KAP

Kap Ø80/Kap Ø80 Plus - Fixed - Optic Spot

Light Source: Kap Ø80: LED Array DC 500 mA - 9,2W - 935 lm - 2700K/CRI 90 / 9,2W - 974 lm - 3000K/CRI 90
Kap Ø80 Plus: LED Array DC 700 mA - 13W - 1370 lm - 2700K/CRI 90 / 13W - 1460 lm - 3000K/CRI 90

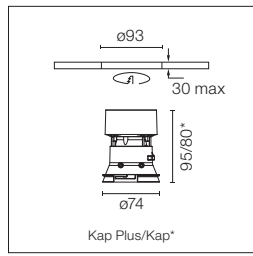

	GWT 850°		IP 54
	0,24 Kg		
	LED INCL		
	IECEE		LED INCL
	CE		III

LED Einbauleuchte. Ohne Netzgerät. Recessed luminaire with LED light source. Power supply not included. Diffusorlinse inbegriffen. Diffusing lens included. Vorinstallationsrahmen. Muss separat bestellt werden. Pre-installation frame. To be ordered separately.

Empfohlene Netzgeräte / Recommended power supply*:

	Kap Ø80	Kap Ø80 Plus
Non Dimmable	60.9160	60.9592
Dimmable 0/1-10V	60.9188	60.9188
Dimmable Dali 1	60.8847	60.8847
Dimmable Dali 2	60.9222	60.9222
Mains Dimming	60.9411	60.9467
Casambi	60.9207	60.9207

* Siehe Treiberkapitel / Refer to the Drivers chapter

- 2700K**
 Kap Ø80
 03.4531.B1
 Kap Ø80 Plus
 05.7451.B1

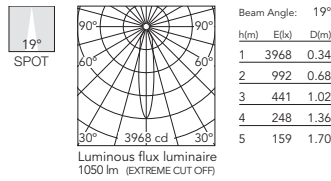

- 3000K**
 Kap Ø80
 03.4530.B1
 Kap Ø80 Plus
 05.7450.B1

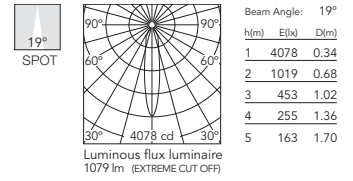

- Kap Ø80
 03.4531.GL
 Kap Ø80 Plus
 05.7451.GL

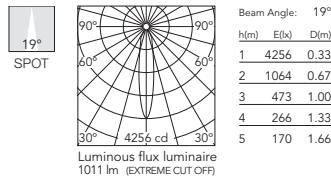

- Kap Ø80
 03.4530.GL
 Kap Ø80 Plus
 05.7450.GL

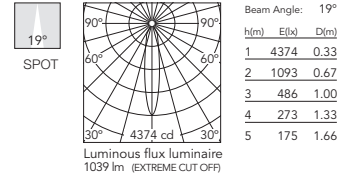

- Kap Ø80
 03.4531.BU
 Kap Ø80 Plus
 05.7451.BU

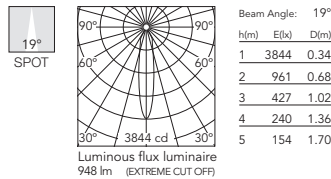

- Kap Ø80
 03.4530.BU
 Kap Ø80 Plus
 05.7450.BU

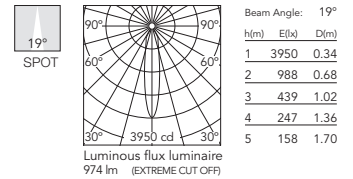

- Kap Ø80
 03.4531.74
 Kap Ø80 Plus
 05.7451.74

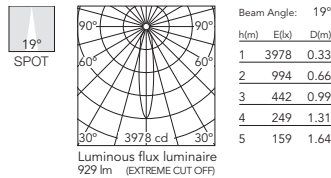

- Kap Ø80
 03.4530.74
 Kap Ø80 Plus
 05.7450.74

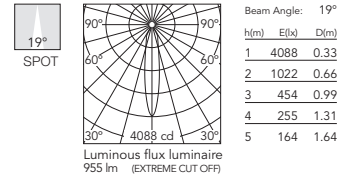

- Kap Ø80
 03.4531.CU
 Kap Ø80 Plus
 05.7451.CU

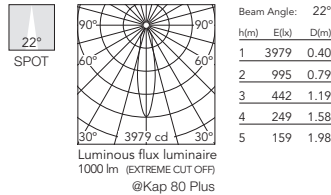

- Kap Ø80
 03.4530.CU
 Kap Ø80 Plus
 05.7450.CU

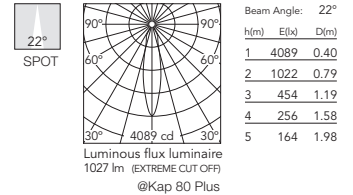

KAP

Kap Ø80 Fixed - Optic Spot - Dim To Warm

Light Source: LED Array DC 300mA - 13W - max 940lm - 1800K - 2850K/CRI 95 - Dim To Warm

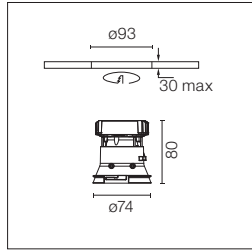

LED Einbauleuchte. 220-240V und dimmbares 1-10V Netzteil inklusive. Für Versionen mit 110-V-Geräten wenden Sie sich an das Frontoffice. Diffusorlinse inbegriffen. Vorinstallationsrahmen. Muss separat bestellt werden.

Recessed luminaire with LED light source. 220-240V & dimmable 1-10V power supply included. For 110V PSU versions, please consult with the front office. Diffusing lens included. Pre-installation frame. To be ordered separately.

1800K-2850K
 03.4530.B1.LE

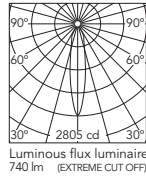

Beam Angle: 20°

h(m)	E(lx)	D(m)
1	2805	0.35
2	701	0.69
3	312	1.04
4	175	1.39
5	112	1.74

Luminous flux luminaire
740 lm (EXTREME CUT OFF)

03.4530.GL.LE

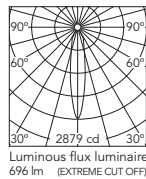

Beam Angle: 19°

h(m)	E(lx)	D(m)
1	2879	0.33
2	720	0.67
3	320	1.00
4	180	1.33
5	115	1.67

Luminous flux luminaire
696 lm (EXTREME CUT OFF)

03.4530.BU.LE

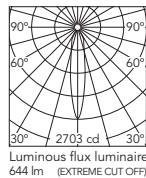

Beam Angle: 19°

h(m)	E(lx)	D(m)
1	2703	0.33
2	676	0.66
3	300	0.99
4	169	1.32
5	108	1.65

Luminous flux luminaire
644 lm (EXTREME CUT OFF)

03.4530.74.LE

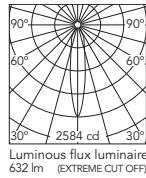

Beam Angle: 19°

h(m)	E(lx)	D(m)
1	2584	0.34
2	646	0.68
3	287	1.02
4	161	1.35
5	103	1.69

Luminous flux luminaire
632 lm (EXTREME CUT OFF)

03.4530.CU.LE

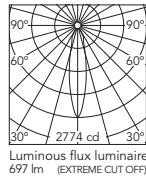

Beam Angle: 22°

h(m)	E(lx)	D(m)
1	2774	0.38
2	693	0.76
3	308	1.14
4	173	1.53
5	111	1.91

Luminous flux luminaire
697 lm (EXTREME CUT OFF)

KAP

Kap Ø80/Kap Ø80 Plus - Fixed - Optic Medium

Light Source: Kap Ø80: LED Array DC 500 mA - 9,2W - 935 lm - 2700K/CRI 90 / 9,2W - 974 lm - 3000K/CRI 90
Kap Ø80 Plus: LED Array DC 700 mA - 13W - 1370 lm - 2700K/CRI 90 / 13W - 1460 lm - 3000K/CRI 90

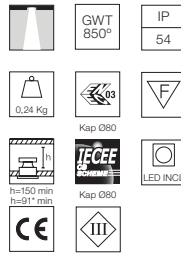
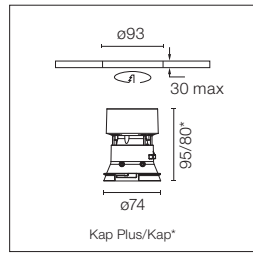

LED Einbauleuchte. Ohne Netzgerät. Recessed luminaire with LED light source. Power supply not included. Diffusorlinse inbegriffen. Diffusing lens included. Vorinstallationsrahmen. Muss separat bestellt werden. Pre-installation frame. To be ordered separately.

Empfohlene Netzgeräte / Recommended power supply*:

	Kap Ø80	Kap Ø80 Plus
Non Dimmable	60.9160	60.9592
Dimmable 0/1-10V	60.9188	60.9188
Dimmable Dali 1	60.8847	60.8847
Dimmable Dali 2	60.9222	60.9222
Mains Dimming	60.9411	60.9467
Casambi	60.9207	60.9207

* Siehe Treiberkapitel / Refer to the Drivers chapter

- 2700K**
 Kap Ø80
 03.4181.B1
 Kap Ø80 Plus
 05.7411.B1

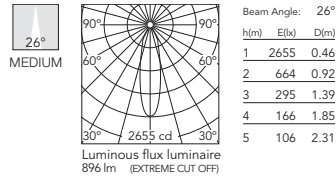

- 3000K**
 Kap Ø80
 03.4180.B1
 Kap Ø80 Plus
 05.7410.B1

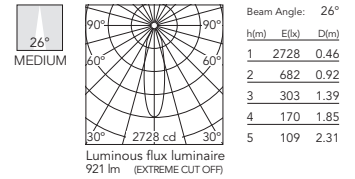

- Kap Ø80
 03.4181.GL
 Kap Ø80 Plus
 05.7411.GL

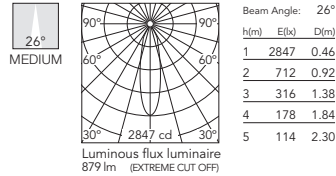

- Kap Ø80
 03.4180.GL
 Kap Ø80 Plus
 05.7410.GL

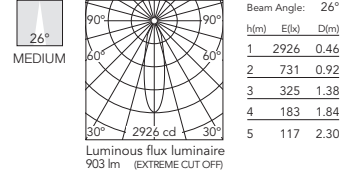

- Kap Ø80
 03.4181.BU
 Kap Ø80 Plus
 05.7411.BU

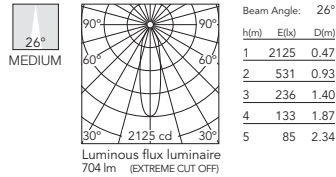

- Kap Ø80
 03.4180.BU
 Kap Ø80 Plus
 05.7410.BU

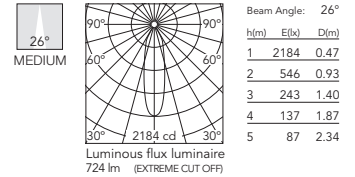

- Kap Ø80
 03.4181.74
 Kap Ø80 Plus
 05.7411.74

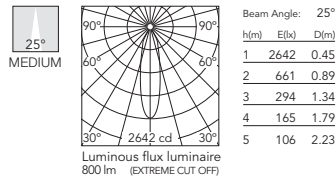

- Kap Ø80
 03.4180.74
 Kap Ø80 Plus
 05.7410.74

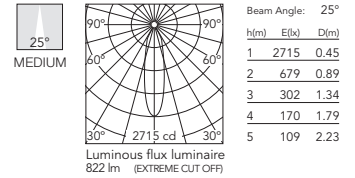

- Kap Ø80
 03.4181.CU
 Kap Ø80 Plus
 05.7411.CU

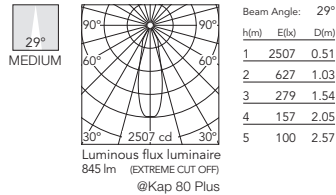

- Kap Ø80
 03.4180.CU
 Kap Ø80 Plus
 05.7410.CU

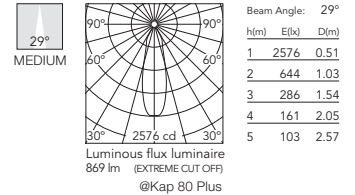

KAP

Kap Ø80 Fixed - Optic Medium - Dim To Warm

Light Source: LED Array DC 300mA - 13W - max 940lm - 1800K - 2850K/CRI 95 - Dim To Warm

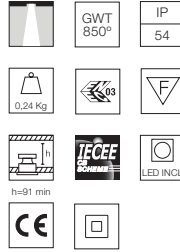
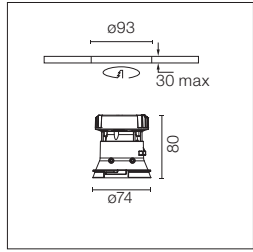

LED Einbauleuchte. 220-240V und dimmbares 1-10V Netzteil inklusive. Für Versionen mit 110-V-Geräten wenden Sie sich an das Frontoffice. Diffusorlinse inbegriffen. Vorinstallationsrahmen. Muss separat bestellt werden.

Recessed luminaire with LED light source. 220-240V & dimmable 1-10V power supply included. For 110V PSU versions, please consult with the front office. Diffusing lens included. Pre-installation frame. To be ordered separately.

1800K-2850K
 03.4180.B1.LE

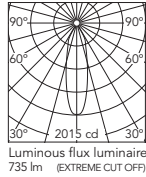

Beam Angle: 27°

h(m)	E(lx)	D(m)
1	2015	0.49
2	504	0.98
3	224	1.46
4	126	1.95
5	81	2.44

03.4180.GL.LE

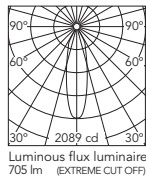

Beam Angle: 27°

h(m)	E(lx)	D(m)
1	2089	0.47
2	522	0.95
3	232	1.42
4	131	1.89
5	84	2.37

03.4180.BU.LE

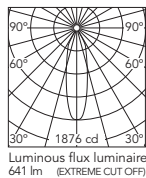

Beam Angle: 27°

h(m)	E(lx)	D(m)
1	1876	0.48
2	469	0.96
3	208	1.44
4	117	1.92
5	75	2.40

03.4180.74.LE

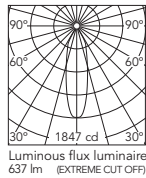

Beam Angle: 28°

h(m)	E(lx)	D(m)
1	1847	0.49
2	462	0.98
3	205	1.47
4	115	1.96
5	74	2.45

03.4180.CU.LE

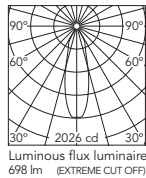

Beam Angle: 29°

h(m)	E(lx)	D(m)
1	2026	0.52
2	506	1.04
3	225	1.56
4	127	2.09
5	81	2.61

KAP

Kap Ø80/Kap Ø80 Plus - Fixed - Optic Flood

Light Source: Kap Ø80: LED Array DC 500 mA - 9,2W - 935 lm - 2700K/CRI 90 / 9,2W - 974 lm - 3000K/CRI 90
Kap Ø80 Plus: LED Array DC 700 mA - 13W - 1370 lm - 2700K/CRI 90 / 13W - 1460 lm - 3000K/CRI 90

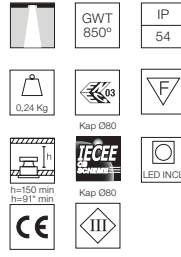
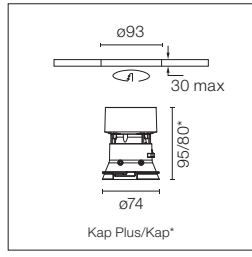

LED Einbauleuchte. Ohne Netzgerät. Recessed luminaire with LED light source. Power supply not included. Diffusorlinse inbegriffen. Diffusing lens included. Vorinstallationsrahmen. Muss separat bestellt werden. Pre-installation frame. To be ordered separately.

Empfohlene Netzgeräte / Recommended power supply*:

	Kap Ø80	Kap Ø80 Plus
Non Dimmable	60.9160	60.9592
Dimmable 0/1-10V	60.9188	60.9188
Dimmable Dali 1	60.8847	60.8847
Dimmable Dali 2	60.9222	60.9222
Mains Dimming	60.9411	60.9467
Casambi	60.9207	60.9207

* Siehe Treiberkapitel / Refer to the Drivers chapter

- 2700K**
 Kap Ø80
 03.4533.B1
 Kap Ø80 Plus
 05.7453.B1

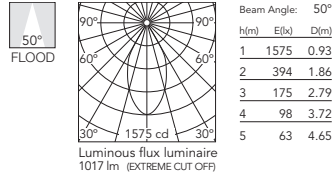

- 3000K**
 Kap Ø80
 03.4532.B1
 Kap Ø80 Plus
 05.7452.B1

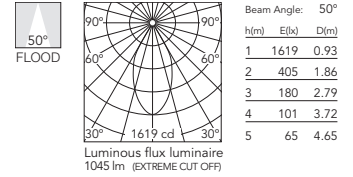

- Kap Ø80
 03.4533.GL
 Kap Ø80 Plus
 05.7453.GL

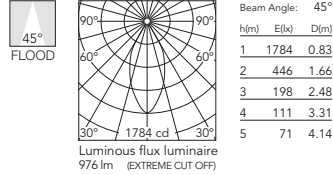

- Kap Ø80
 03.4532.GL
 Kap Ø80 Plus
 05.7452.GL

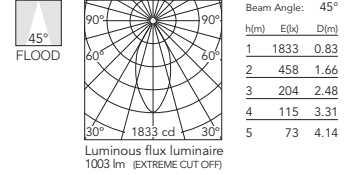

- Kap Ø80
 03.4533.BU
 Kap Ø80 Plus
 05.7453.BU

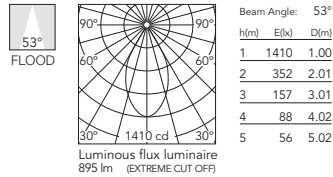

- Kap Ø80
 03.4532.BU
 Kap Ø80 Plus
 05.7452.BU

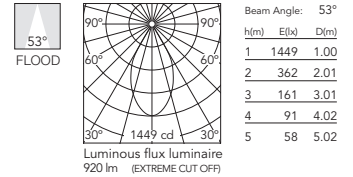

- Kap Ø80
 03.4533.74
 Kap Ø80 Plus
 05.7453.74

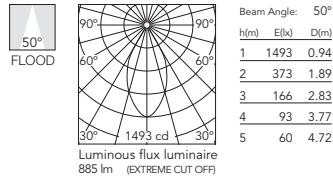

- Kap Ø80
 03.4532.74
 Kap Ø80 Plus
 05.7452.74

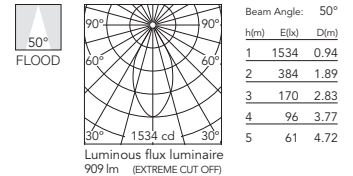

- Kap Ø80
 03.4533.CU
 Kap Ø80 Plus
 05.7453.CU

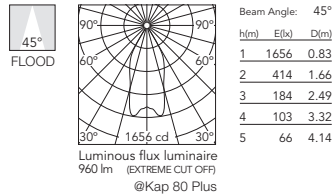

- Kap Ø80
 03.4532.CU
 Kap Ø80 Plus
 05.7452.CU

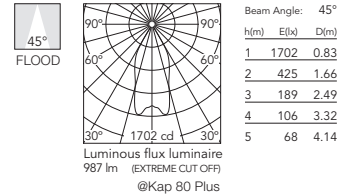

KAP

Kap Ø80 Fixed - Optic Flood - Dim To Warm

Light Source: LED Array DC 300mA - 13W - max 940lm - 1800K - 2850K/CRI 95 - Dim To Warm

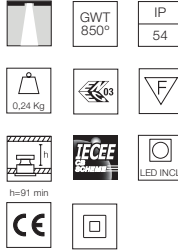
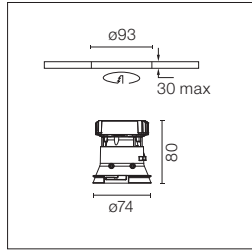

LED Einbauleuchte. 220-240V und dimmbares 1-10V Netzteil inklusive. Für Versionen mit 110-V-Geräten wenden Sie sich an das Frontoffice. Diffusorlinse inbegriffen. Vorinstallationsrahmen. Muss separat bestellt werden.

Recessed luminaire with LED light source. 220-240V & dimmable 1-10V power supply included. For 110V PSU versions, please consult with the front office. Diffusing lens included. Pre-installation frame. To be ordered separately.

1800K-2850K

03.4532.B1.LE

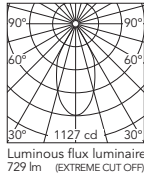

Beam Angle: 49°

h(m)	E(lx)	D(m)
1	1127	0.92
2	282	1.83
3	125	2.75
4	70	3.67
5	45	4.59

03.4532.GL.LE

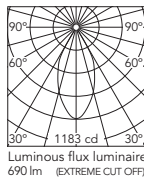

Beam Angle: 47°

h(m)	E(lx)	D(m)
1	1183	0.87
2	296	1.75
3	131	2.62
4	74	3.50
5	47	4.37

03.4532.BU.LE

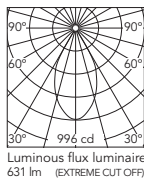

Beam Angle: 53°

h(m)	E(lx)	D(m)
1	996	1.00
2	249	1.99
3	111	2.99
4	62	3.98
5	40	4.98

03.4532.74.LE

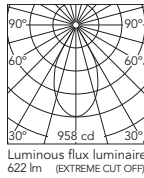

Beam Angle: 54°

h(m)	E(lx)	D(m)
1	958	1.02
2	239	2.04
3	106	3.06
4	60	4.09
5	38	5.11

03.4532.CU.LE

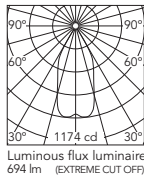

Beam Angle: 46°

h(m)	E(lx)	D(m)
1	1174	0.86
2	293	1.71
3	130	2.57
4	73	3.42
5	47	4.28

KAP

Kap 80/Kap 80 Plus Square - Fixed - Optic Spot

Light Source: Kap 80: LED Array DC 500 mA - 9,2W - 935 lm - 2700K/CRI 90 / 9,2W - 974 lm - 3000K/CRI 90

Kap 80 Plus: LED Array DC 700 mA - 13W - 1370 lm - 2700K/CRI 90 / 13W - 1460 lm - 3000K/CRI 90

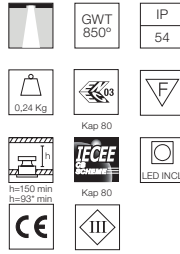
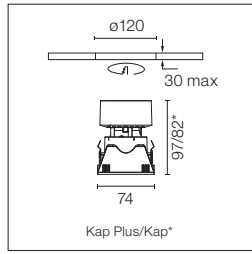

LED Einbauleuchte. Ohne Netzgerät.
Diffusorlinse inbegriffen.
Vorinstallationsrahmen. Muss
separat bestellt werden.

Recessed luminaire with LED light
source. Power supply not included.
Diffusing lens included.
Pre-installation frame. To be ordered
separately.

Empfohlene Netzgeräte / Recommended power supply*:

	Kap 80	Kap 80 Plus
Non Dimmable	60.9160	60.9592
Dimmable 0/1-10V	60.9188	60.9188
Dimmable Dali 1	60.8847	60.8847
Dimmable Dali 2	60.9222	60.9222
Mains Dimming	60.9411	60.9467
Casambi	60.9207	60.9207

* Siehe Treiberkapitel / Refer to the Drivers chapter

- 2700K**
Kap 80
□ 03.4535.B1
Kap 80 Plus
□ 05.7455.B1

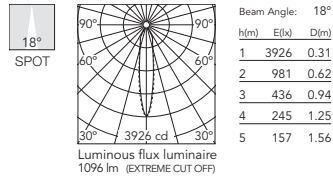

- 3000K**
Kap 80
□ 03.4534.B1
Kap 80 Plus
□ 05.7454.B1

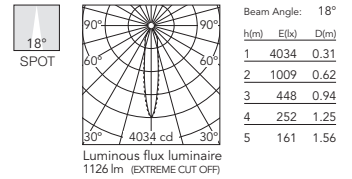

- Kap 80
■ 03.4535.GL
Kap 80 Plus
■ 05.7455.GL

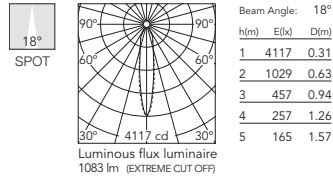

- Kap 80
■ 03.4534.GL
Kap 80 Plus
■ 05.7454.GL

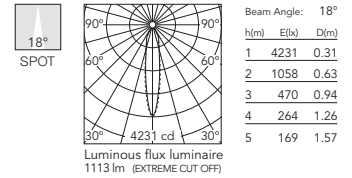

- Kap 80
■ 03.4535.BU
Kap 80 Plus
■ 05.7455.BU

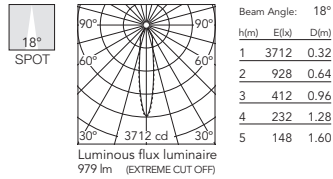

- Kap 80
■ 03.4534.BU
Kap 80 Plus
■ 05.7454.BU

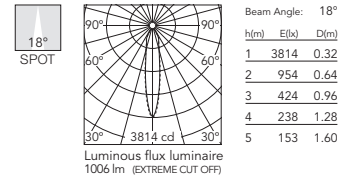

- Kap 80
■ 03.4535.74
Kap 80 Plus
■ 05.7455.74

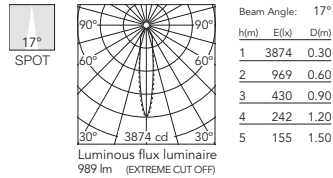

- Kap 80
■ 03.4534.74
Kap 80 Plus
■ 05.7454.74

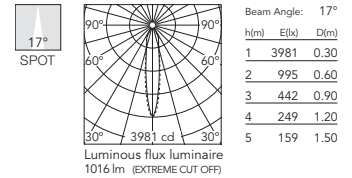

- Kap 80
■ 03.4535.CU
Kap 80 Plus
■ 05.7455.CU

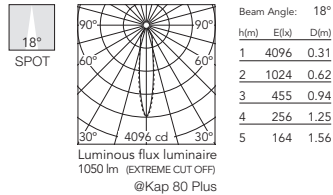

- Kap 80
■ 03.4534.CU
Kap 80 Plus
■ 05.7454.CU

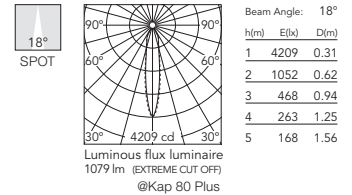

KAP

Kap 80 Square Fixed - Optic Spot - Dim To Warm

Light Source: LED Array DC 300mA - 13W - max 940lm - 1800K - 2850K/CRI 95 - Dim To Warm

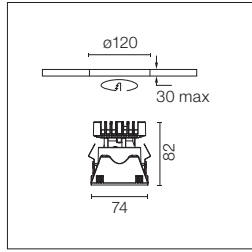

LED Einbauleuchte. 220-240V und dimmbares 1-10V Netzteil inklusive. Für Versionen mit 110-V-Geräten wenden Sie sich an das Frontoffice. Diffusorlinse inbegriffen. Vorinstallationsrahmen. Muss separat bestellt werden.

Recessed luminaire with LED light source. 220-240V & dimmable 1-10V power supply included. For 110V PSU versions, please consult with the front office. Diffusing lens included. Pre-installation frame. To be ordered separately.

1800K-2850K
 03.4534.B1.LE

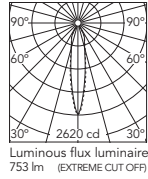

Beam Angle: 18°

h(m)	E(lx)	D(m)
1	2620	0.32
2	655	0.64
3	291	0.96
4	164	1.28
5	105	1.60

03.4534.GL.LE

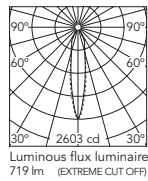

Beam Angle: 18°

h(m)	E(lx)	D(m)
1	2603	0.32
2	651	0.64
3	289	0.96
4	163	1.28
5	104	1.60

03.4534.BU.LE

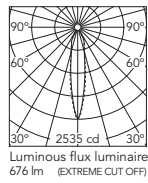

Beam Angle: 18°

h(m)	E(lx)	D(m)
1	2535	0.31
2	634	0.63
3	282	0.94
4	158	1.26
5	101	1.57

03.4534.74.LE

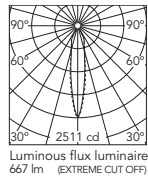

Beam Angle: 18°

h(m)	E(lx)	D(m)
1	2511	0.31
2	628	0.63
3	279	0.94
4	157	1.25
5	100	1.57

03.4534.CU.LE

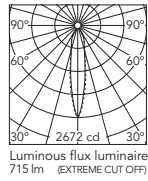

Beam Angle: 18°

h(m)	E(lx)	D(m)
1	2672	0.32
2	668	0.64
3	297	0.96
4	167	1.29
5	107	1.61

KAP

Kap 80/Kap 80 Plus Square - Fixed - Optic Medium

Light Source: Kap 80: LED Array DC 500 mA - 9,2W - 935 lm - 2700K/CRI 90 / 9,2W - 974 lm - 3000K/CRI 90

Kap 80 Plus: LED Array DC 700 mA - 13W - 1370 lm - 2700K/CRI 90 / 13W - 1460 lm - 3000K/CRI 90

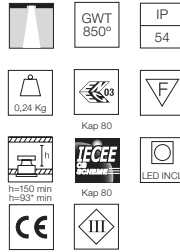
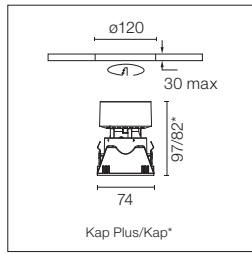

LED Einbauleuchte. Ohne Netzgerät.
Diffusorlinse inbegriffen.
Vorinstallationsrahmen. Muss
separat bestellt werden.

Recessed luminaire with LED light
source. Power supply not included.
Diffusing lens included.
Pre-installation frame. To be ordered
separately.

Empfohlene Netzgeräte / Recommended power supply*:

	Kap 80	Kap 80 Plus
Non Dimmable	60.9160	60.9592
Dimmable 0/1-10V	60.9188	60.9188
Dimmable Dali 1	60.8847	60.8847
Dimmable Dali 2	60.9222	60.9222
Mains Dimming	60.9411	60.9467
Casambi	60.9207	60.9207

* Siehe Treiberkapitel / Refer to the Drivers chapter

- 2700K**
Kap 80
□ 03.4183.B1
Kap 80 Plus
□ 05.7413.B1

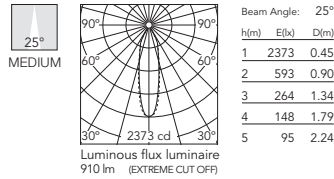

- 3000K**
Kap 80
□ 03.4182.B1
Kap 80 Plus
□ 05.7412.B1

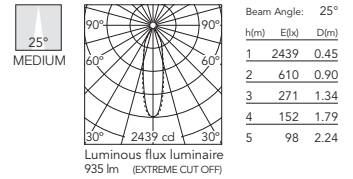

- Kap 80
■ 03.4183.GL
Kap 80 Plus
■ 05.7413.GL

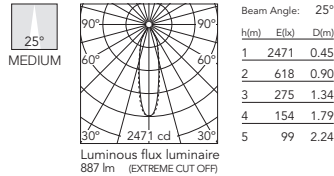

- Kap 80
■ 03.4182.GL
Kap 80 Plus
■ 05.7412.GL

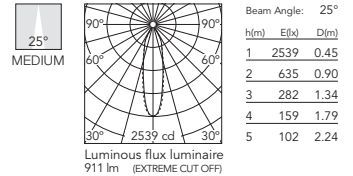

- Kap 80
■ 03.4183.BU
Kap 80 Plus
■ 05.7413.BU

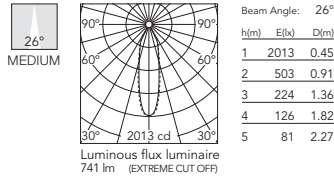

- Kap 80
■ 03.4182.BU
Kap 80 Plus
■ 05.7412.BU

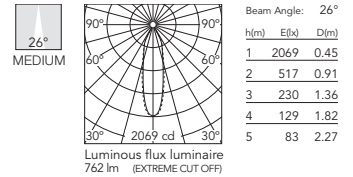

- Kap 80
■ 03.4183.74
Kap 80 Plus
■ 05.7413.74

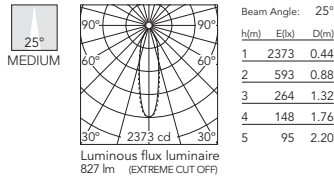

- Kap 80
■ 03.4182.74
Kap 80 Plus
■ 05.7412.74

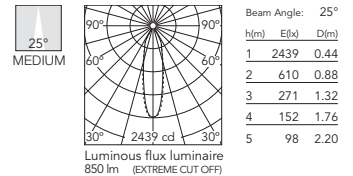

- Kap 80
■ 03.4183.CU
Kap 80 Plus
■ 05.7413.CU

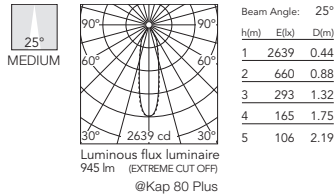

- Kap 80
■ 03.4182.CU
Kap 80 Plus
■ 05.7412.CU

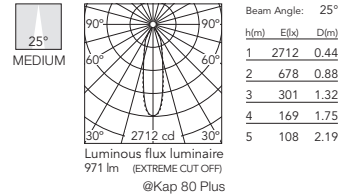

KAP

Kap 80 Square Fixed - Optic Medium - Dim To Warm

Light Source: LED Array DC 300mA - 13W - max 940lm - 1800K - 2850K/CRI 95 - Dim To Warm

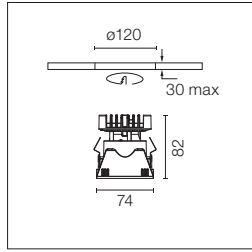

LED Einbauleuchte. 220-240V und dimmbares 1-10V Netzteil inklusive. Für Versionen mit 110-V-Geräten wenden Sie sich an das Frontoffice. Diffusorlinse inbegriffen. Vorinstallationsrahmen. Muss separat bestellt werden.

Recessed luminaire with LED light source. 220-240V & dimmable 1-10V power supply included. For 110V PSU versions, please consult with the front office. Diffusing lens included. Pre-installation frame. To be ordered separately.

1800K-2850K
 03.4182.B1.LE

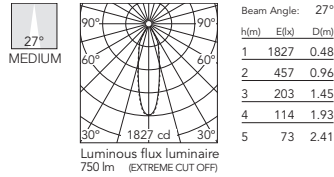

03.4182.GL.LE

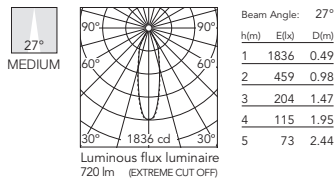

03.4182.BU.LE

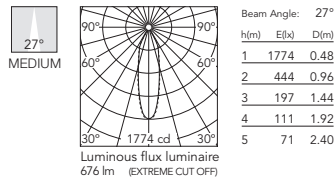

03.4182.74.LE

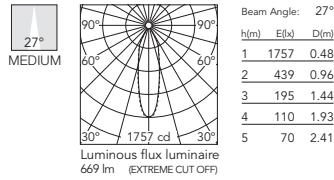

03.4182.CU.LE

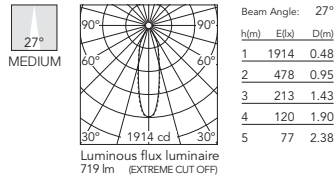

KAP

Kap 80/Kap 80 Plus Square - Fixed - Optic Flood

Light Source: Kap 80: LED Array DC 500 mA - 9,2W - 935 lm - 2700K/CRI 90 / 9,2W - 974 lm - 3000K/CRI 90

Kap 80 Plus: LED Array DC 700 mA - 13W - 1370 lm - 2700K/CRI 90 / 13W - 1460 lm - 3000K/CRI 90

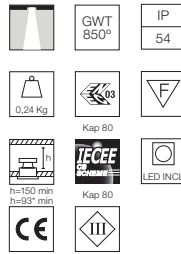
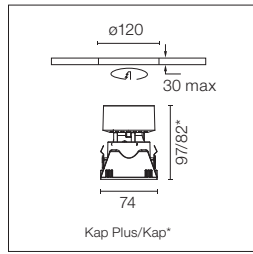

LED Einbauleuchte. Ohne Netzgerät.
Diffusorlinse inbegriffen.
Vorinstallationsrahmen. Muss
separat bestellt werden.

Recessed luminaire with LED light
source. Power supply not included.
Diffusing lens included.
Pre-installation frame. To be ordered
separately.

Empfohlene Netzgeräte / Recommended power supply*:

	Kap 80	Kap 80 Plus
Non Dimmable	60.9160	60.9592
Dimmable 0/1-10V	60.9188	60.9188
Dimmable Dali 1	60.8847	60.8847
Dimmable Dali 2	60.9222	60.9222
Mains Dimming	60.9411	60.9467
Casambi	60.9207	60.9207

* Siehe Treiberkapitel / Refer to the Drivers chapter

- 2700K**
Kap 80
□ 03.4537.B1
□ Kap 80 Plus
□ 05.7457.B1

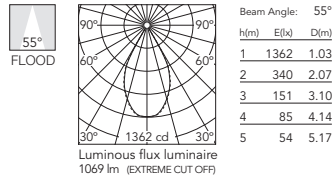

- 3000K**
Kap 80
□ 03.4536.B1
□ Kap 80 Plus
□ 05.7456.B1

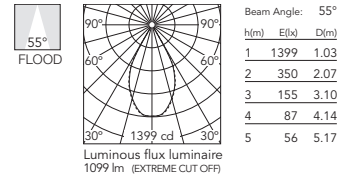

- Kap 80
■ 03.4537.GL
Kap 80 Plus
■ 05.7457.GL

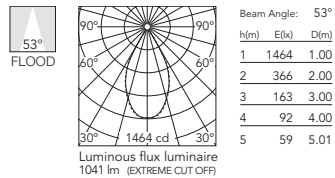

- Kap 80
■ 03.4536.GL
Kap 80 Plus
■ 05.7456.GL

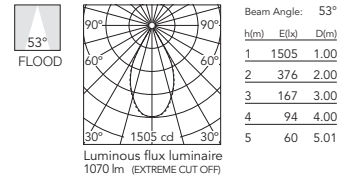

- Kap 80
■ 03.4537.BU
Kap 80 Plus
■ 05.7457.BU

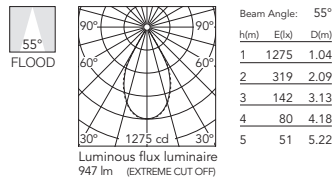

- Kap 80
■ 03.4536.BU
Kap 80 Plus
■ 05.7456.BU

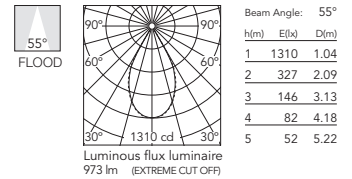

- Kap 80
■ 03.4537.74
Kap 80 Plus
■ 05.7457.74

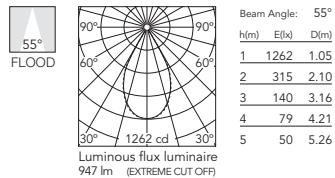

- Kap 80
■ 03.4536.74
Kap 80 Plus
■ 05.7456.74

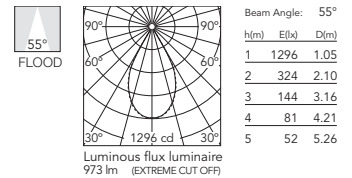

- Kap 80
■ 03.4537.CU
Kap 80 Plus
■ 05.7457.CU

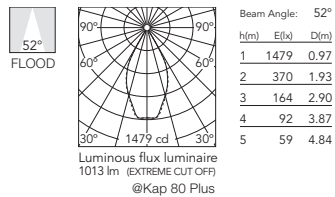

- Kap 80
■ 03.4536.CU
Kap 80 Plus
■ 05.7456.CU

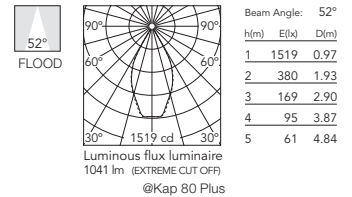

KAP

Kap 80 Square Fixed - Optic Flood - Dim To Warm

Light Source: LED Array DC 300mA - 13W - max 940lm - 1800K - 2850K/CRI 95 - Dim To Warm

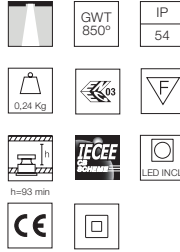
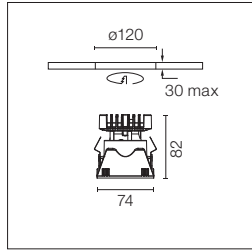

LED Einbauleuchte. 220-240V und dimmbares 1-10V Netzteil inklusive. Für Versionen mit 110-V-Geräten wenden Sie sich an das Frontoffice. Diffusorlinse inbegriffen. Vorinstallationsrahmen. Muss separat bestellt werden.

Recessed luminaire with LED light source. 220-240V & dimmable 1-10V power supply included. For 110V PSU versions, please consult with the front office. Diffusing lens included. Pre-installation frame. To be ordered separately.

1800K-2850K
03.4536.B1.LE

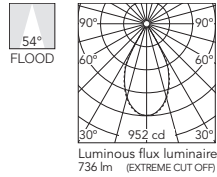

Beam Angle: 54°

h(m)	E(lx)	D(m)
1	952	1.02
2	238	2.04
3	106	3.06
4	59	4.08
5	38	5.10

03.4536.GL.LE

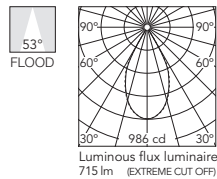

Beam Angle: 53°

h(m)	E(lx)	D(m)
1	986	1.00
2	247	2.01
3	110	3.01
4	62	4.01
5	39	5.02

03.4536.BU.LE

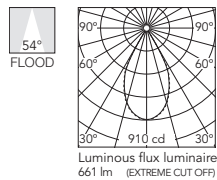

Beam Angle: 54°

h(m)	E(lx)	D(m)
1	910	1.02
2	227	2.05
3	101	3.07
4	57	4.09
5	36	5.12

03.4536.74.LE

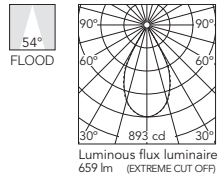

Beam Angle: 54°

h(m)	E(lx)	D(m)
1	893	1.03
2	223	2.05
3	99	3.08
4	56	4.11
5	36	5.14

03.4536.CU.LE

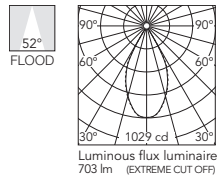

Beam Angle: 52°

h(m)	E(lx)	D(m)
1	1029	0.97
2	257	1.94
3	114	2.92
4	64	3.89
5	41	4.86

KAP

Kap Ø80 Fixed

Light Source: LED QR-CBC 51 GX5.3

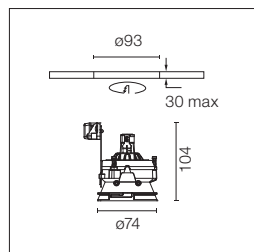

Einbauleuchte für 12V lampe.
Separater Transformator nicht
inbegriffen.
Objektivzubehör nicht erhältlich.
Vorinstallationsrahmen. Muss
separat bestellt werden.

Recessed 12V lamp luminaire.
Remote transformer not included.
Not suitable for lens accessories.
Pre-installation frame. To be ordered
separately.

- 03.4228.B1
- 03.4228.GL
- 03.4228.BU
- 03.4228.74
- 03.4228.CU

Kap 80 Square Fixed

Light Source: LED QR-CBC 51 GX5.3

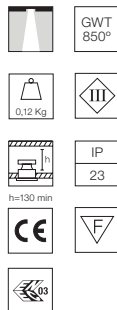
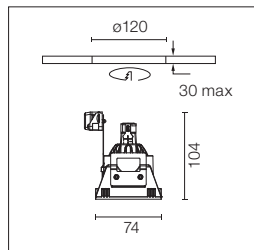

Einbauleuchte für 12V lampe.
Separater Transformator nicht
inbegriffen.
Objektivzubehör nicht erhältlich.
Vorinstallationsrahmen. Muss
separat bestellt werden.

Recessed 12V lamp luminaire.
Remote transformer not included.
Not suitable for lens accessories.
Pre-installation frame. To be ordered
separately.

- 03.4226.B1
- 03.4226.GL
- 03.4226.BU
- 03.4226.74
- 03.4226.CU

Kap Ø80 Fixed

Light Source: LED PAR 16 GZ10

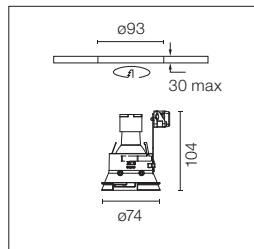

Einbauleuchte für Netzspannung.
Objektivzubehör nicht erhältlich.
Vorinstallationsrahmen. Muss
separat bestellt werden.

Recessed luminaire with main
voltage source.
Not suitable for lens accessories.
Pre-installation frame. To be ordered
separately.

- 03.4229.B1
- 03.4229.GL
- 03.4229.BU
- 03.4229.74
- 03.4229.CU

Kap 80 Square Fixed

Light Source: LED PAR 16 GZ10

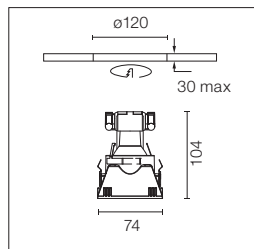
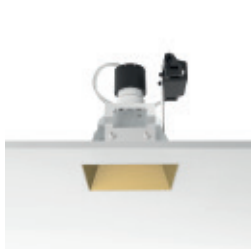

Einbauleuchte für Netzspannung.
Objektivzubehör nicht erhältlich.
Vorinstallationsrahmen. Muss
separat bestellt werden.

Recessed luminaire with main
voltage source.
Not suitable for lens accessories.
Pre-installation frame. To be ordered
separately.

- 03.4227.B1
- 03.4227.GL
- 03.4227.BU
- 03.4227.74
- 03.4227.CU

KAP

Kap Ø80/Kap Ø80 Plus - Adjustable - Optic Spot

Light Source: Kap Ø80: LED Array DC 500 mA - 9,2W - 935 lm - 2700K/CRI 90 / 9,2W - 974 lm - 3000K/CRI 90
Kap Ø80 Plus: LED Array DC 700 mA - 13W - 1370 lm - 2700K/CRI 90 / 13W - 1460 lm - 3000K/CRI 90

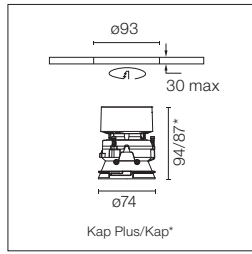

LED Einbauleuchte. Ohne Netzgerät. Recessed luminaire with LED light source. Power supply not included. Diffusorlinse inbegriffen. Diffusing lens included. Vorinstallationsrahmen. Muss separat bestellt werden. Pre-installation frame. To be ordered separately.

Empfohlene Netzgeräte / Recommended power supply*:

	Kap Ø80	Kap Ø80 Plus
Non Dimmable	60.9160	60.9592
Dimmable 0/1-10V	60.9188	60.9188
Dimmable Dali 1	60.8847	60.8847
Dimmable Dali 2	60.9222	60.9222
Mains Dimming	60.9411	60.9467
Casambi	60.9207	60.9207

* Siehe Treiberkapitel / Refer to the Drivers chapter

- 2700K**
 Kap Ø80
 03.4539.B1
 Kap Ø80 Plus
 05.7459.B1

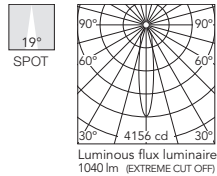

- 3000K**
 Kap Ø80
 03.4538.B1
 Kap Ø80 Plus
 05.7458.B1

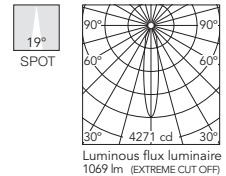

- Kap Ø80
 03.4539.GL
 Kap Ø80 Plus
 05.7459.GL

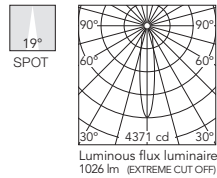

- Kap Ø80
 03.4538.GL
 Kap Ø80 Plus
 05.7458.GL

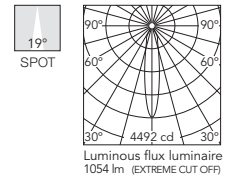

- Kap Ø80
 03.4539.BU
 Kap Ø80 Plus
 05.7459.BU

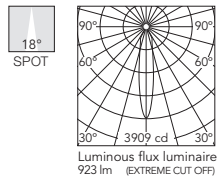

- Kap Ø80
 03.4538.BU
 Kap Ø80 Plus
 05.7458.BU

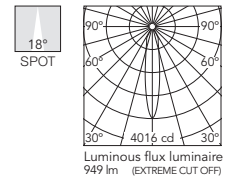

- Kap Ø80
 03.4539.74
 Kap Ø80 Plus
 05.7459.74

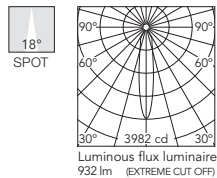

- Kap Ø80
 03.4538.74
 Kap Ø80 Plus
 05.7458.74

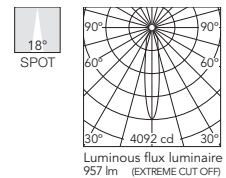

- Kap Ø80
 03.4539.CU
 Kap Ø80 Plus
 05.7459.CU

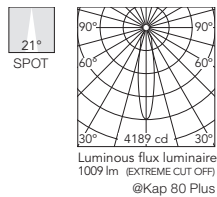

- Kap Ø80
 03.4538.CU
 Kap Ø80 Plus
 05.7458.CU

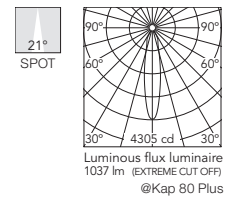

KAP

Kap Ø80 Adjustable - Optic Spot - Dim To Warm

Light Source: LED Array DC 300mA - 13W - max 940lm - 1800K - 2850K/CRI 95 - Dim To Warm

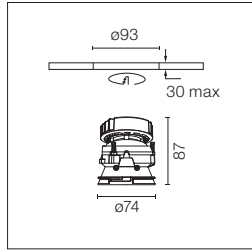

LED Einbauleuchte. 220-240V und dimmbares 1-10V Netzteil inklusive. Für Versionen mit 110-V-Geräten wenden Sie sich an das Frontoffice. Diffusorlinse inbegriffen. Vorinstallationsrahmen. Muss separat bestellt werden.

Recessed luminaire with LED light source. 220-240V & dimmable 1-10V power supply included. For 110V PSU versions, please consult with the front office. Diffusing lens included. Pre-installation frame. To be ordered separately.

1800K-2850K
 03.4538.B1.LE

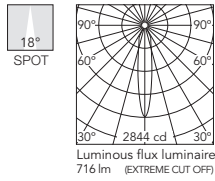

h(m)	E(lx)	D(m)
1	2844	0.31
2	711	0.63
3	316	0.94
4	178	1.25
5	114	1.56

03.4538.GL.LE

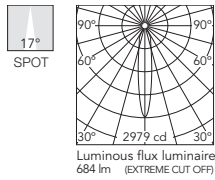

h(m)	E(lx)	D(m)
1	2979	0.30
2	745	0.61
3	331	0.91
4	186	1.21
5	119	1.52

03.4538.BU.LE

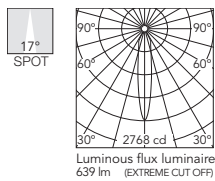

h(m)	E(lx)	D(m)
1	2768	0.31
2	692	0.61
3	308	0.92
4	173	1.22
5	111	1.53

03.4538.74.LE

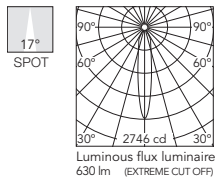

h(m)	E(lx)	D(m)
1	2746	0.31
2	687	0.61
3	305	0.92
4	172	1.22
5	110	1.53

03.4538.CU.LE

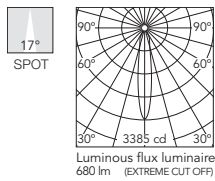

h(m)	E(lx)	D(m)
1	3385	0.30
2	846	0.60
3	376	0.90
4	212	1.20
5	135	1.50

KAP

Kap Ø80/Kap Ø80 Plus - Adjustable - Optic Medium

Light Source: Kap Ø80: LED Array DC 500 mA - 9,2W - 935 lm - 2700K/CRI 90 / 9,2W - 974 lm - 3000K/CRI 90
Kap Ø80 Plus: LED Array DC 700 mA - 13W - 1370 lm - 2700K/CRI 90 / 13W - 1460 lm - 3000K/CRI 90

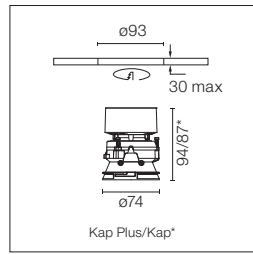

LED Einbauleuchte. Ohne Netzgerät. Recessed luminaire with LED light source. Power supply not included. Diffusorlinse inbegriffen. Diffusing lens included. Vorinstallationsrahmen. Muss separat bestellt werden. Pre-installation frame. To be ordered separately.

Empfohlene Netzgeräte / Recommended power supply*:

	Kap Ø80	Kap Ø80 Plus
Non Dimmable	60.9160	60.9592
Dimmable 0/1-10V	60.9188	60.9188
Dimmable Dali 1	60.8847	60.8847
Dimmable Dali 2	60.9222	60.9222
Mains Dimming	60.9411	60.9467
Casambi	60.9207	60.9207

* Siehe Treiberkapitel / Refer to the Drivers chapter

- 2700K**
 Kap Ø80
 03.4185.B1
 Kap Ø80 Plus
 05.7415.B1

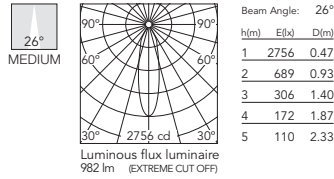

- 3000K**
 Kap Ø80
 03.4184.B1
 Kap Ø80 Plus
 05.7414.B1

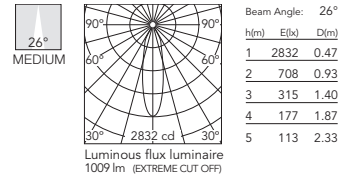

- Kap Ø80
 03.4185.GL
 Kap Ø80 Plus
 05.7415.GL

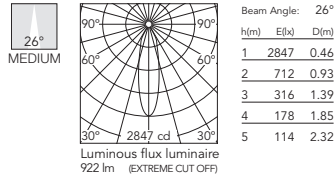

- Kap Ø80
 03.4184.GL
 Kap Ø80 Plus
 05.7414.GL

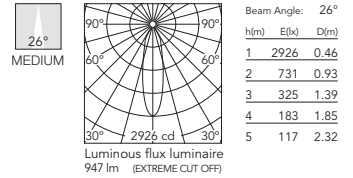

- Kap Ø80
 03.4185.BU
 Kap Ø80 Plus
 05.7415.BU

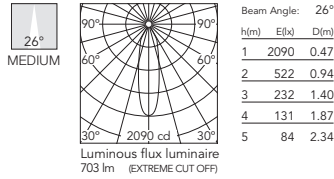

- Kap Ø80
 03.4184.BU
 Kap Ø80 Plus
 05.7414.BU

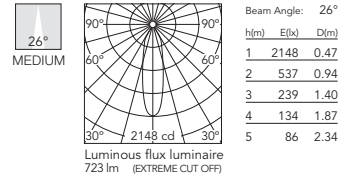

- Kap Ø80
 03.4185.74
 Kap Ø80 Plus
 05.7415.74

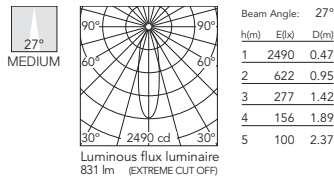

- Kap Ø80
 03.4184.74
 Kap Ø80 Plus
 05.7414.74

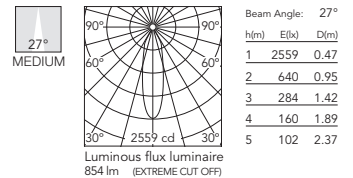

- Kap Ø80
 03.4185.CU
 Kap Ø80 Plus
 05.7415.CU

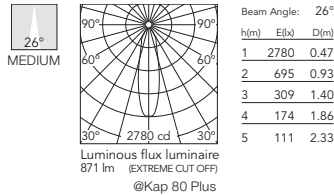

- Kap Ø80
 03.4184.CU
 Kap Ø80 Plus
 05.7414.CU

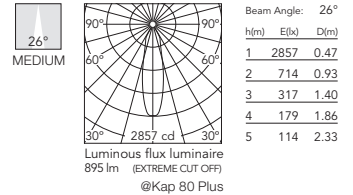

KAP

Kap Ø80 Adjustable - Optic Medium - Dim To Warm

Light Source: LED Array DC 300mA - 13W - max 940lm - 1800K - 2850K/CRI 95 - Dim To Warm

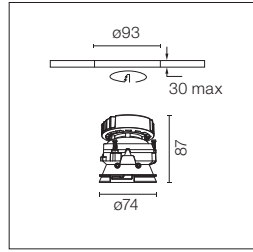

LED Einbauleuchte. 220-240V und dimmbares 1-10V Netzteil inklusive. Für Versionen mit 110-V-Geräten wenden Sie sich an das Frontoffice. Diffusorlinse inbegriffen. Vorinstallationsrahmen. Muss separat bestellt werden.

Recessed luminaire with LED light source. 220-240V & dimmable 1-10V power supply included. For 110V PSU versions, please consult with the front office. Diffusing lens included. Pre-installation frame. To be ordered separately.

1800K-2850K
 03.4184.B1.LE

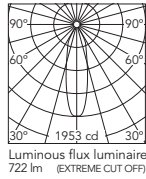

Beam Angle: 27°

h(m)	E(lx)	D(m)
1	1953	0.48
2	488	0.97
3	217	1.45
4	122	1.94
5	78	2.42

03.4184.GL.LE

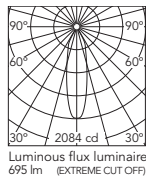

Beam Angle: 26°

h(m)	E(lx)	D(m)
1	2084	0.46
2	521	0.92
3	232	1.38
4	130	1.85
5	83	2.31

03.4184.BU.LE

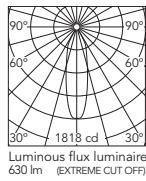

Beam Angle: 28°

h(m)	E(lx)	D(m)
1	1818	0.49
2	454	0.98
3	202	1.47
4	114	1.96
5	73	2.45

03.4184.74.LE

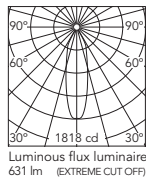

Beam Angle: 28°

h(m)	E(lx)	D(m)
1	1818	0.49
2	455	0.99
3	202	1.48
4	114	1.97
5	73	2.46

03.4184.CU.LE

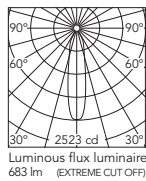

Beam Angle: 22°

h(m)	E(lx)	D(m)
1	2523	0.39
2	631	0.78
3	280	1.17
4	158	1.56
5	101	1.95

KAP

Kap Ø80/Kap Ø80 Plus - Adjustable - Optic Flood

Light Source: Kap Ø80: LED Array DC 500 mA - 9,2W - 935 lm - 2700K/CRI 90 / 9,2W - 974 lm - 3000K/CRI 90
Kap Ø80 Plus: LED Array DC 700 mA - 13W - 1370 lm - 2700K/CRI 90 / 13W - 1460 lm - 3000K/CRI 90

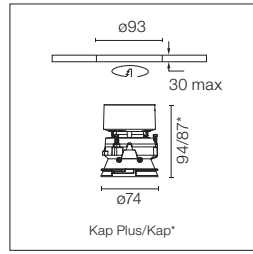

LED Einbauleuchte. Ohne Netzgerät. Recessed luminaire with LED light source. Power supply not included. Diffusorlinse inbegriffen. Diffusing lens included. Vorinstallationsrahmen. Muss separat bestellt werden. Pre-installation frame. To be ordered separately.

Empfohlene Netzgeräte / Recommended power supply*:

	Kap Ø80	Kap Ø80 Plus
Non Dimmable	60.9160	60.9592
Dimmable 0/1-10V	60.9188	60.9188
Dimmable Dali 1	60.8847	60.8847
Dimmable Dali 2	60.9222	60.9222
Mains Dimming	60.9411	60.9467
Casambi	60.9207	60.9207

* Siehe Treiberkapitel / Refer to the Drivers chapter

- 2700K**
 Kap Ø80
 03.4541.B1
 Kap Ø80 Plus
 05.7461.B1

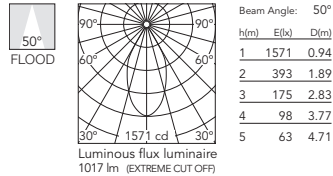

- 3000K**
 Kap Ø80
 03.4540.B1
 Kap Ø80 Plus
 05.7460.B1

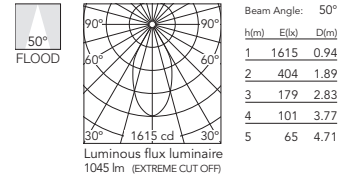

- Kap Ø80
 03.4541.GL
 Kap Ø80 Plus
 05.7461.GL

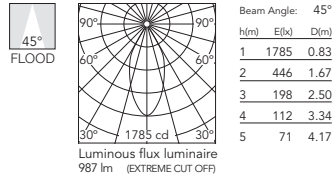

- Kap Ø80
 03.4540.GL
 Kap Ø80 Plus
 05.7460.GL

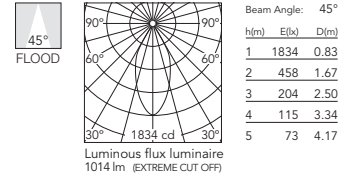

- Kap Ø80
 03.4541.BU
 Kap Ø80 Plus
 05.7461.BU

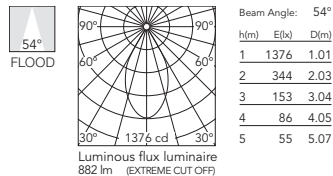

- Kap Ø80
 03.4540.BU
 Kap Ø80 Plus
 05.7460.BU

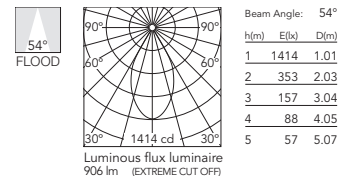

- Kap Ø80
 03.4541.74
 Kap Ø80 Plus
 05.7461.74

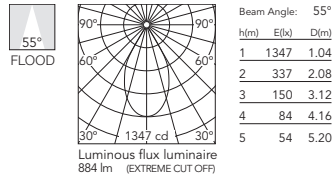

- Kap Ø80
 03.4540.74
 Kap Ø80 Plus
 05.7460.74

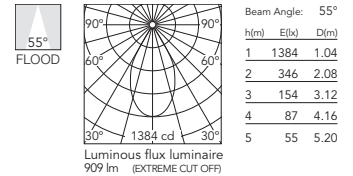

- Kap Ø80
 03.4541.CU
 Kap Ø80 Plus
 05.7461.CU

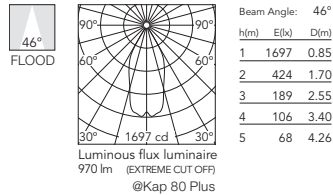

- Kap Ø80
 03.4540.CU
 Kap Ø80 Plus
 05.7460.CU

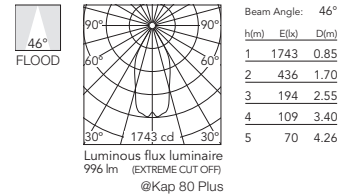

KAP

Kap Ø80 Adjustable - Optic Flood - Dim To Warm

Light Source: LED Array DC 300mA - 13W - max 940lm - 1800K - 2850K/CRI 95 - Dim To Warm

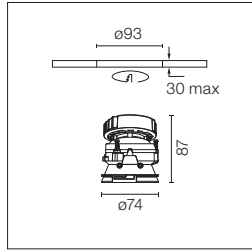

LED Einbauleuchte. 220-240V und dimmbares 1-10V Netzteil inklusive. Für Versionen mit 110-V-Geräten wenden Sie sich an das Frontoffice. Diffusorlinse inbegriffen. Vorinstallationsrahmen. Muss separat bestellt werden.

Recessed luminaire with LED light source. 220-240V & dimmable 1-10V power supply included. For 110V PSU versions, please consult with the front office. Diffusing lens included. Pre-installation frame. To be ordered separately.

1800K-2850K
 03.4540.B1.LE

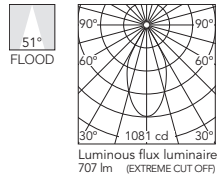

Beam Angle: 51°

h(m)	E(lx)	D(m)
1	1081	0.94
2	270	1.89
3	120	2.83
4	68	3.78
5	43	4.72

03.4540.GL.LE

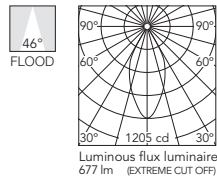

Beam Angle: 46°

h(m)	E(lx)	D(m)
1	1205	0.85
2	301	1.71
3	134	2.56
4	75	3.41
5	48	4.26

03.4540.BU.LE

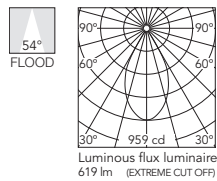

Beam Angle: 54°

h(m)	E(lx)	D(m)
1	959	1.01
2	240	2.02
3	107	3.03
4	60	4.04
5	38	5.05

03.4540.74.LE

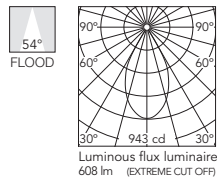

Beam Angle: 54°

h(m)	E(lx)	D(m)
1	943	1.01
2	236	2.03
3	105	3.04
4	59	4.06
5	38	5.07

03.4540.CU.LE

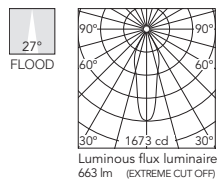

Beam Angle: 27°

h(m)	E(lx)	D(m)
1	1673	0.49
2	418	0.97
3	186	1.46
4	105	1.94
5	67	2.43

KAP

Kap 80/Kap 80 Plus Square - Adjustable - Optic Spot

Light Source: Kap 80: LED Array DC 500 mA - 9,2W - 935 lm - 2700K/CRI 90 / 9,2W - 974 lm - 3000K/CRI 90

Kap 80 Plus: LED Array DC 700 mA - 13W - 1370 lm - 2700K/CRI 90 / 13W - 1460 lm - 3000K/CRI 90

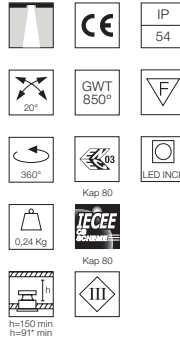
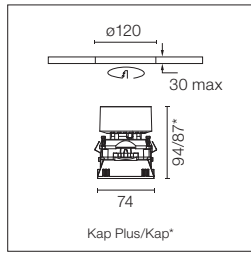

LED Einbauleuchte. Ohne Netzgerät.
Diffusorlinse inbegriffen.
Vorinstallationsrahmen. Muss
separat bestellt werden.

Recessed luminaire with LED light
source. Power supply not included.
Diffusing lens included.
Pre-installation frame. To be ordered
separately.

Empfohlene Netzgeräte / Recommended power supply*:

	Kap 80	Kap 80 Plus
Non Dimmable	60.9160	60.9592
Dimmable 0/1-10V	60.9188	60.9188
Dimmable Dali 1	60.8847	60.8847
Dimmable Dali 2	60.9222	60.9222
Mains Dimming	60.9411	60.9467
Casambi	60.9207	60.9207

* Siehe Treiberkapitel / Refer to the Drivers chapter

- 2700K**
Kap 80
□ 03.4543.B1
Kap 80 Plus
□ 05.7463.B1

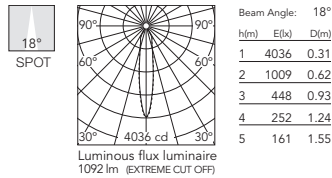

- 3000K**
Kap 80
□ 03.4542.B1
Kap 80 Plus
□ 05.7462.B1

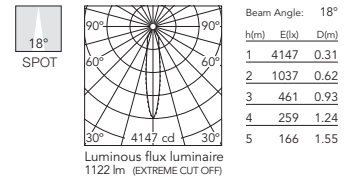

- Kap 80
■ 03.4543.GL
Kap 80 Plus
■ 05.7463.GL

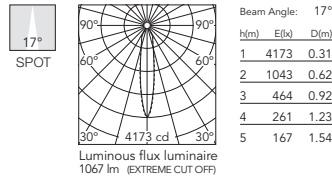

- Kap 80
■ 03.4542.GL
Kap 80 Plus
■ 05.7462.GL

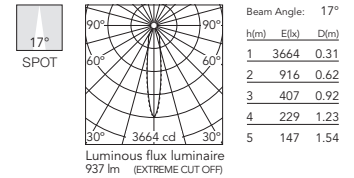

- Kap 80
■ 03.4543.BU
Kap 80 Plus
■ 05.7463.BU

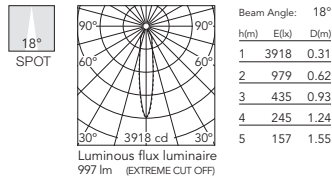

- Kap 80
■ 03.4542.BU
Kap 80 Plus
■ 05.7462.BU

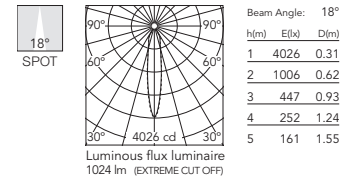

- Kap 80
■ 03.4543.74
Kap 80 Plus
■ 05.7463.74

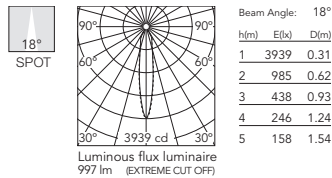

- Kap 80
■ 03.4542.74
Kap 80 Plus
■ 05.7462.74

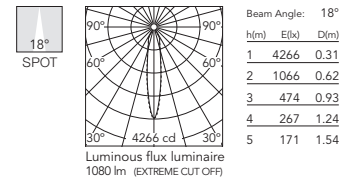

- Kap 80
■ 03.4543.CU
Kap 80 Plus
■ 05.7463.CU

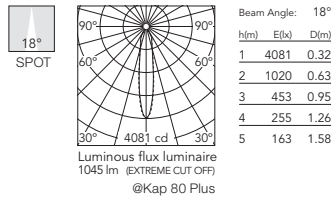

- Kap 80
■ 03.4542.CU
Kap 80 Plus
■ 05.7462.CU

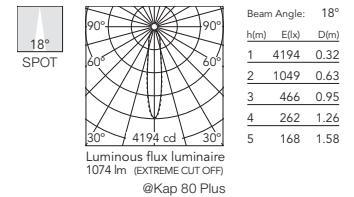

KAP

Kap 80 Square Adjustable - Optic Spot - Dim To Warm

Light Source: LED Array DC 300mA - 13W - max 940lm - 1800K - 2850K/CRI 95 - Dim To Warm

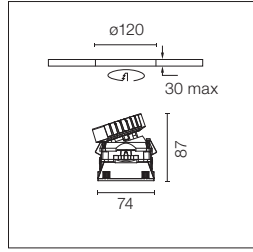

LED Einbauleuchte. 220-240V und dimmbares 1-10V Netzteil inklusive. Für Versionen mit 110-V-Geräten wenden Sie sich an das Frontoffice. Diffusorlinse inbegriffen. Vorinstallationsrahmen. Muss separat bestellt werden.

Recessed luminaire with LED light source. 220-240V & dimmable 1-10V power supply included. For 110V PSU versions, please consult with the front office. Diffusing lens included. Pre-installation frame. To be ordered separately.

1800K-2850K
 03.4542.B1.LE

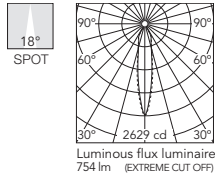

Beam Angle: 18°

h(m)	E(lx)	D(m)
1	2629	0.31
2	657	0.63
3	292	0.94
4	164	1.26
5	105	1.57

03.4542.GL.LE

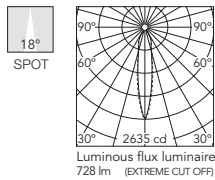

Beam Angle: 18°

h(m)	E(lx)	D(m)
1	2635	0.32
2	659	0.63
3	293	0.95
4	165	1.26
5	105	1.58

03.4542.BU.LE

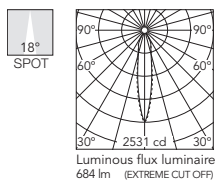

Beam Angle: 18°

h(m)	E(lx)	D(m)
1	2531	0.31
2	633	0.63
3	281	0.94
4	158	1.26
5	101	1.57

03.4542.74.LE

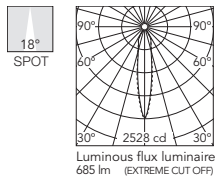

Beam Angle: 18°

h(m)	E(lx)	D(m)
1	2528	0.31
2	632	0.63
3	281	0.94
4	158	1.25
5	101	1.57

03.4542.CU.LE

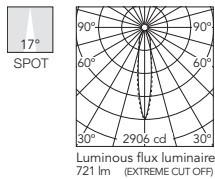

Beam Angle: 17°

h(m)	E(lx)	D(m)
1	2906	0.30
2	726	0.59
3	323	0.89
4	182	1.18
5	116	1.48

KAP

Kap 80/Kap 80 Plus Square - Adjustable - Optic Medium

Light Source: Kap 80: LED Array DC 500 mA - 9,2W - 935 lm - 2700K/CRI 90 / 9,2W - 974 lm - 3000K/CRI 90

Kap 80 Plus: LED Array DC 700 mA - 13W - 1370 lm - 2700K/CRI 90 / 13W - 1460 lm - 3000K/CRI 90

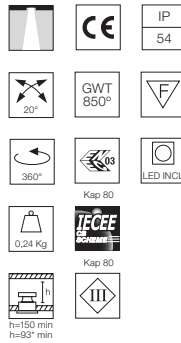
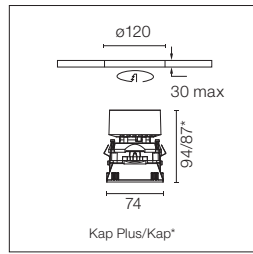

LED Einbauleuchte. Ohne Netzgerät.
Diffusorlinse inbegriffen.
Vorinstallationsrahmen. Muss separat bestellt werden.

Recessed luminaire with LED light source. Power supply not included. Diffusing lens included. Pre-installation frame. To be ordered separately.

Empfohlene Netzgeräte / Recommended power supply*:

	Kap 80	Kap 80 Plus
Non Dimmable	60.9160	60.9592
Dimmable 0/1-10V	60.9188	60.9188
Dimmable Dali 1	60.8847	60.8847
Dimmable Dali 2	60.9222	60.9222
Mains Dimming	60.9411	60.9467
Casambi	60.9207	60.9207

* Siehe Treiberkapitel / Refer to the Drivers chapter

- 2700K**
Kap 80
□ 03.4187.B1
Kap 80 Plus
□ 05.7417.B1

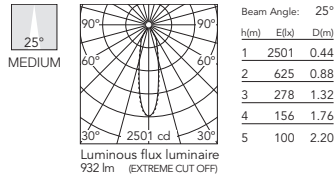

- 3000K**
Kap 80
□ 03.4186.B1
Kap 80 Plus
□ 05.7416.B1

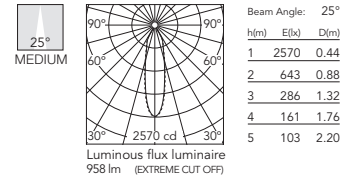

- Kap 80
■ 03.4187.GL
Kap 80 Plus
■ 05.7417.GL

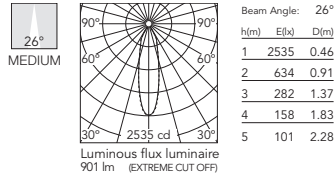

- Kap 80
■ 03.4186.GL
Kap 80 Plus
■ 05.7416.GL

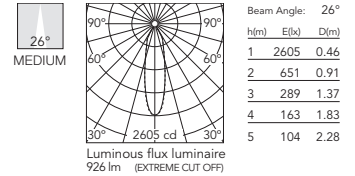

- Kap 80
■ 03.4187.BU
Kap 80 Plus
■ 05.7417.BU

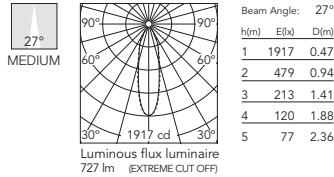

- Kap 80
■ 03.4186.BU
Kap 80 Plus
■ 05.7416.BU

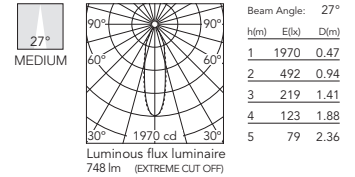

- Kap 80
■ 03.4187.74
Kap 80 Plus
■ 05.7417.74

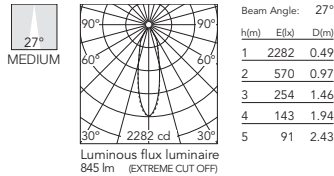

- Kap 80
■ 03.4186.74
Kap 80 Plus
■ 05.7416.74

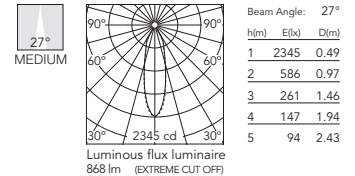

- Kap 80
■ 03.4187.CU
Kap 80 Plus
■ 05.7417.CU

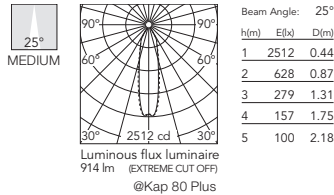

- Kap 80
■ 03.4186.CU
Kap 80 Plus
■ 05.7416.CU

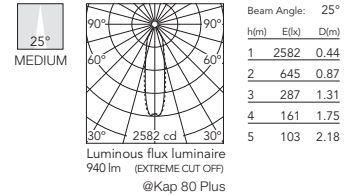

KAP

Kap 80 Square Adjustable - Optic Medium - Dim To Warm

Light Source: LED Array DC 300mA - 13W - max 940lm - 1800K - 2850K/CRI 95 - Dim To Warm

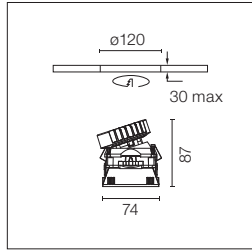

LED Einbauleuchte. 220-240V und dimmbares 1-10V Netzteil inklusive. Für Versionen mit 110-V-Geräten wenden Sie sich an das Frontoffice. Diffusorlinse inbegriffen. Vorinstallationsrahmen. Muss separat bestellt werden.

Recessed luminaire with LED light source. 220-240V & dimmable 1-10V power supply included. For 110V PSU versions, please consult with the front office. Diffusing lens included. Pre-installation frame. To be ordered separately.

1800K-2850K
 03.4186.B1.LE

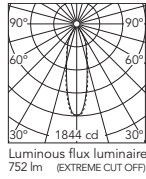

Beam Angle: 26°

h(m)	E(lx)	D(m)
1	1844	0.47
2	461	0.94
3	205	1.41
4	115	1.88
5	74	2.35

03.4186.GL.LE

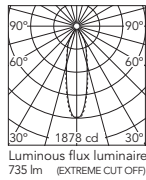

Beam Angle: 27°

h(m)	E(lx)	D(m)
1	1878	0.47
2	470	0.95
3	209	1.42
4	117	1.89
5	75	2.37

03.4186.BU.LE

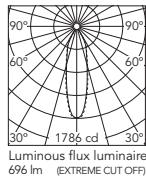

Beam Angle: 27°

h(m)	E(lx)	D(m)
1	1786	0.47
2	447	0.95
3	198	1.42
4	112	1.89
5	71	2.37

03.4186.74.LE

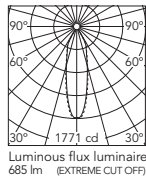

Beam Angle: 27°

h(m)	E(lx)	D(m)
1	1771	0.48
2	443	0.96
3	197	1.44
4	111	1.93
5	71	2.41

03.4186.CU.LE

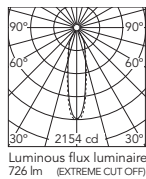

Beam Angle: 22°

h(m)	E(lx)	D(m)
1	2154	0.40
2	538	0.79
3	239	1.19
4	135	1.59
5	86	1.98

KAP

Kap 80/Kap 80 Plus Square - Adjustable - Optic Flood

Light Source: Kap 80: LED Array DC 500 mA - 9,2W - 935 lm - 2700K/CRI 90 / 9,2W - 974 lm - 3000K/CRI 90

Kap 80 Plus: LED Array DC 700 mA - 13W - 1370 lm - 2700K/CRI 90 / 13W - 1460 lm - 3000K/CRI 90

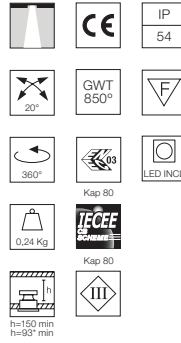
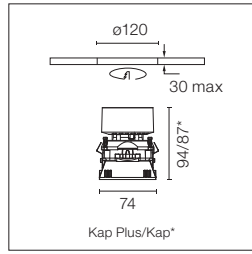

LED Einbauleuchte. Ohne Netzgerät.
Diffusorlinse inbegriffen.
Vorinstallationsrahmen. Muss
separat bestellt werden.

Recessed luminaire with LED light
source. Power supply not included.
Diffusing lens included.
Pre-installation frame. To be ordered
separately.

Empfohlene Netzgeräte / Recommended power supply*:

	Kap 80	Kap 80 Plus
Non Dimmable	60.9160	60.9592
Dimmable 0/1-10V	60.9188	60.9188
Dimmable Dali 1	60.8847	60.8847
Dimmable Dali 2	60.9222	60.9222
Mains Dimming	60.9411	60.9467
Casambi	60.9207	60.9207

* Siehe Treiberkapitel / Refer to the Drivers chapter

- 2700K**
Kap 80
□ 03.4545.B1
Kap 80 Plus
□ 05.7465.B1

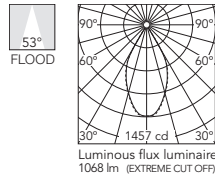

Beam Angle: 53°

h(m)	E(lx)	D(m)
1	1457	0.99
2	364	1.98
3	162	2.98
4	91	3.97
5	58	4.96

- 3000K**
Kap 80
□ 03.4544.B1
PlusPro
□ 05.7464.B1

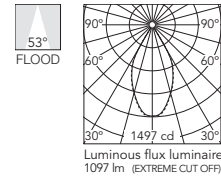

Beam Angle: 53°

h(m)	E(lx)	D(m)
1	1497	0.99
2	374	1.98
3	166	2.98
4	94	3.97
5	60	4.96

- Kap 80
■ 03.4545.GL
Kap 80 Plus
■ 05.7465.GL

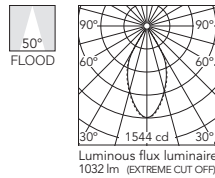

Beam Angle: 50°

h(m)	E(lx)	D(m)
1	1544	0.93
2	386	1.86
3	172	2.79
4	96	3.72
5	62	4.65

- Kap 80
■ 03.4544.GL
Kap 80 Plus
■ 05.7464.GL

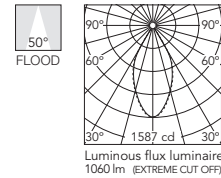

Beam Angle: 50°

h(m)	E(lx)	D(m)
1	1587	0.93
2	397	1.86
3	176	2.79
4	99	3.72
5	63	4.65

- Kap 80
■ 03.4545.BU
Kap 80 Plus
■ 05.7465.BU

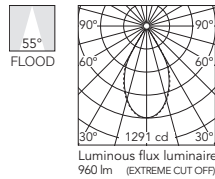

Beam Angle: 55°

h(m)	E(lx)	D(m)
1	1291	1.05
2	323	2.09
3	143	3.14
4	81	4.19
5	52	5.23

- Kap 80
■ 03.4544.BU
Kap 80 Plus
■ 05.7464.BU

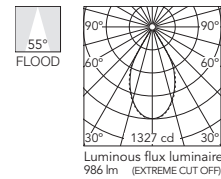

Beam Angle: 55°

h(m)	E(lx)	D(m)
1	1327	1.05
2	332	2.09
3	147	3.14
4	83	4.19
5	53	5.23

- Kap 80
■ 03.4545.74
Kap 80 Plus
■ 05.7465.74

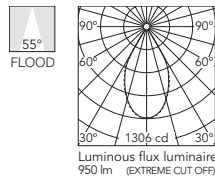

Beam Angle: 55°

h(m)	E(lx)	D(m)
1	1306	1.04
2	326	2.08
3	145	3.11
4	82	4.15
5	52	5.19

- Kap 80
■ 03.4544.74
Kap 80 Plus
■ 05.7464.74

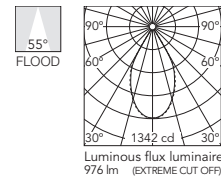

Beam Angle: 55°

h(m)	E(lx)	D(m)
1	1342	1.04
2	335	2.08
3	149	3.11
4	84	4.15
5	54	5.19

- Kap 80
■ 03.4545.CU
Kap 80 Plus
■ 05.7465.CU

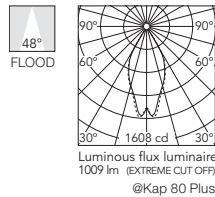

Beam Angle: 48°

h(m)	E(lx)	D(m)
1	1608	0.88
2	402	1.77
3	179	2.65
4	101	3.53
5	64	4.42

- Kap 80
■ 03.4544.CU
Kap 80 Plus
■ 05.7464.CU

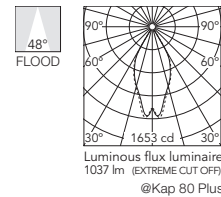

Beam Angle: 48°

h(m)	E(lx)	D(m)
1	1653	0.88
2	413	1.77
3	184	2.65
4	103	3.53
5	66	4.42

KAP

Kap 80 Square Adjustable - Optic Flood - Dim To Warm

Light Source: LED Array DC 300mA - 13W - max 940lm - 1800K - 2850K/CRI 95 - Dim To Warm

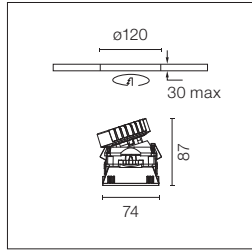

LED Einbauleuchte. 220-240V und dimmbares 1-10V Netzteil inklusive. Für Versionen mit 110-V-Geräten wenden Sie sich an das Frontoffice. Diffusorlinse inbegriffen. Vorinstallationsrahmen. Muss separat bestellt werden.

Recessed luminaire with LED light source. 220-240V & dimmable 1-10V power supply included. For 110V PSU versions, please consult with the front office. Diffusing lens included. Pre-installation frame. To be ordered separately.

1800K-2850K
 03.4544.B1.LE

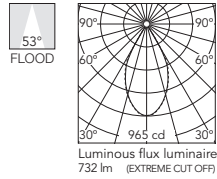

Beam Angle: 53°

h(m)	E(lx)	D(m)
1	965	1.01
2	241	2.01
3	107	3.02
4	60	4.03
5	39	5.03

03.4544.GL.LE

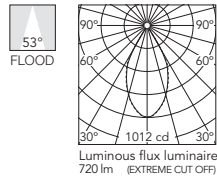

Beam Angle: 53°

h(m)	E(lx)	D(m)
1	1012	0.99
2	253	1.98
3	112	2.97
4	63	3.96
5	40	4.95

03.4544.BU.LE

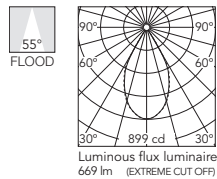

Beam Angle: 55°

h(m)	E(lx)	D(m)
1	899	1.04
2	225	2.08
3	100	3.12
4	56	4.16
5	36	5.21

03.4544.74.LE

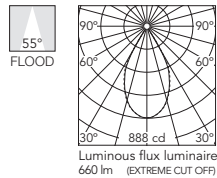

Beam Angle: 55°

h(m)	E(lx)	D(m)
1	888	1.04
2	222	2.07
3	99	3.11
4	55	4.15
5	36	5.18

03.4544.CU.LE

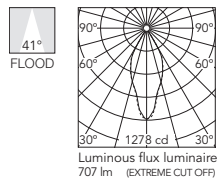

Beam Angle: 41°

h(m)	E(lx)	D(m)
1	1278	0.75
2	319	1.50
3	142	2.25
4	80	3.00
5	51	3.75

KAP

Kap Ø80 Adjustable

Light Source: LED QR-CBC 51 GX5.3

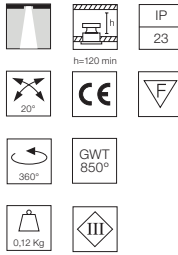
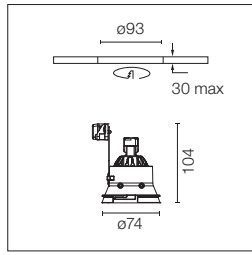

Einbauleuchte für 12V Lampe.
Separater Transformator nicht
inbegriffen.
Objektivzubehör nicht erhältlich.
Vorinstallationsrahmen. Muss
separat bestellt werden.

Recessed 12V lamp luminaire.
Remote transformer not included.
Not suitable for lens accessories.
Pre-installation frame. To be ordered
separately.

- 03.4236.B1
- 03.4236.GL
- 03.4236.BU
- 03.4236.74
- 03.4236.CU

Kap 80 Square Adjustable

Light Source: LED QR-CBC 51 GX5.3

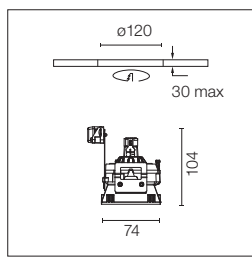

Einbauleuchte für 12V Lampe.
Separater Transformator nicht
inbegriffen.
Objektivzubehör nicht erhältlich.
Vorinstallationsrahmen. Muss
separat bestellt werden.

Recessed 12V lamp luminaire.
Remote transformer not included.
Not suitable for lens accessories.
Pre-installation frame. To be ordered
separately.

- 03.4234.B1
- 03.4234.GL
- 03.4234.BU
- 03.4234.74
- 03.4234.CU

Kap Ø80 Adjustable

Light Source: LED PAR 16 GZ10

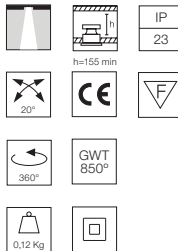
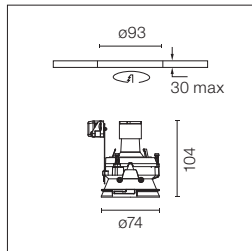

Einbauleuchte für Netzspannung.
Objektivzubehör nicht erhältlich.
Vorinstallationsrahmen. Muss
separat bestellt werden.

Recessed luminaire with main
voltage source.
Not suitable for lens accessories.
Pre-installation frame. To be ordered
separately.

- 03.4237.B1
- 03.4237.GL
- 03.4237.BU
- 03.4237.74
- 03.4237.CU

Kap 80 Square Adjustable

Light Source: LED PAR 16 GZ10

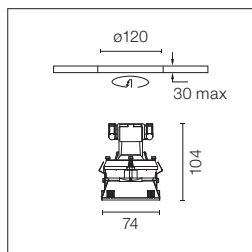

Einbauleuchte für Netzspannung.
Objektivzubehör nicht erhältlich.
Vorinstallationsrahmen. Muss
separat bestellt werden.

Recessed luminaire with main
voltage source.
Not suitable for lens accessories.
Pre-installation frame. To be ordered
separately.

- 03.4235.B1
- 03.4235.GL
- 03.4235.BU
- 03.4235.74
- 03.4235.CU

KAP

Kap Ø80/Kap Ø80 Plus - Wall-Washer

Light Source: Kap Ø80: LED Array DC 500 mA - 9,2W - 935 lm - 2700K/CRI 90 / 9,2W - 974 lm - 3000K/CRI 90
Kap Ø80 Plus: LED Array DC 700 mA - 13W - 1370 lm - 2700K/CRI 90 / 13W - 1460 lm - 3000K/CRI 90

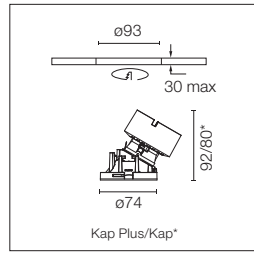

LED
 30°
 III
 0,24 Kg
 GWT 850°
 IP 54
 h=150 mm h=81 mm
 LED INCL
 CE
 TFC EE
 Kap Ø80
 Kap Ø80 Plus

LED Einbauleuchte. Ohne Netzgerät. Recessed luminaire with LED light source. Power supply not included. Elliptische linse enthalten. Elliptical lens included. Vorinstallationsrahmen. Muss separat bestellt werden. Pre-installation frame. To be ordered separately.

Empfohlene Netzgeräte / Recommended power supply*:

	Kap Ø80	Kap Ø80 Plus
Non Dimmable	60.9160	60.9592
Dimmable 0/1-10V	60.9188	60.9188
Dimmable Dali 1	60.8847	60.8847
Dimmable Dali 2	60.9222	60.9222
Mains Dimming	60.9411	60.9467
Casambi	60.9207	60.9207

* Siehe Treiberkapitel / Refer to the Drivers chapter

- 2700K**
 Kap Ø80
 03.4189.B1
 Kap Ø80 Plus
 05.7421.B1

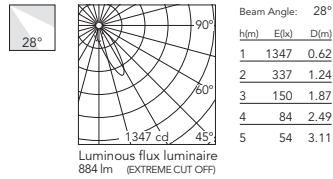

- 3000K**
 Kap Ø80
 03.4188.B1
 Kap Ø80 Plus
 05.7420.B1

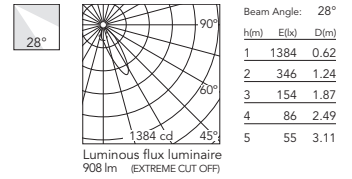

- Kap Ø80
 03.4189.GL
 Kap Ø80 Plus
 05.7421.GL

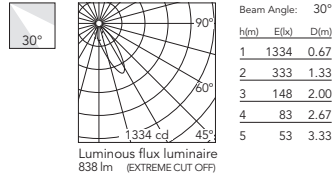

- Kap Ø80
 03.4188.GL
 Kap Ø80 Plus
 05.7420.GL

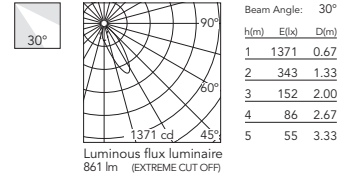

- Kap Ø80
 03.4189.BU
 Kap Ø80 Plus
 05.7421.BU

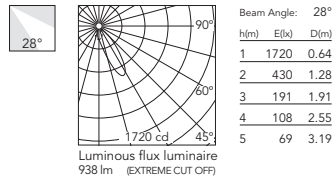

- Kap Ø80
 03.4188.BU
 Kap Ø80 Plus
 05.7420.BU

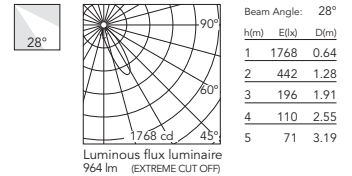

- Kap Ø80
 03.4189.74
 Kap Ø80 Plus
 05.7421.74

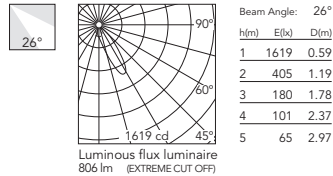

- Kap Ø80
 03.4188.74
 Kap Ø80 Plus
 05.7420.74

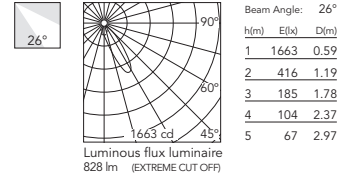

- Kap Ø80
 03.4189.CU
 Kap Ø80 Plus
 05.7421.CU

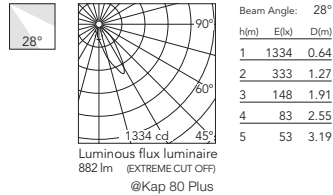

- Kap Ø80
 03.4188.CU
 Kap Ø80 Plus
 05.7420.CU

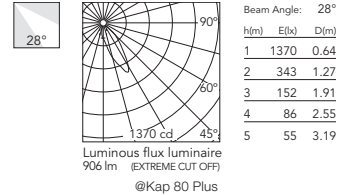

KAP

Kap Ø80 Wall-Washer - Dim To Warm

Light Source: LED Array DC 300mA - 13W - max 940lm - 1800K - 2850K/CRI 95 - Dim To Warm

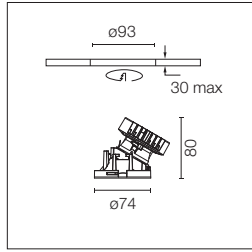

LED Einbauleuchte. 220-240V und dimmbares 1-10V Netzteil inklusive. Für Versionen mit 110-V-Geräten wenden Sie sich an das Frontoffice. Diffusorlinse inbegriffen. Vorinstallationsrahmen. Muss separat bestellt werden.

Recessed luminaire with LED light source. 220-240V & dimmable 1-10V power supply included. For 110V PSU versions, please consult with the front office. Diffusing lens included. Pre-installation frame. To be ordered separately.

1800K-2850K
 03.4188.B1.LE

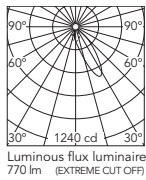

Beam Angle: 28°

h(m)	E(lx)	D(m)
1	1240	0.64
2	310	1.29
3	138	1.93
4	78	2.58
5	50	3.22

03.4188.GL.LE

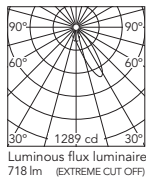

Beam Angle: 27°

h(m)	E(lx)	D(m)
1	1289	0.63
2	322	1.25
3	143	1.88
4	81	2.50
5	52	3.13

03.4188.BU.LE

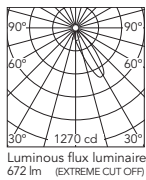

Beam Angle: 28°

h(m)	E(lx)	D(m)
1	1270	0.65
2	317	1.30
3	141	1.96
4	79	2.61
5	51	3.26

03.4188.74.LE

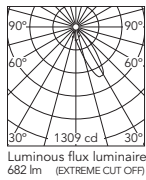

Beam Angle: 28°

h(m)	E(lx)	D(m)
1	1309	0.64
2	327	1.28
3	145	1.92
4	82	2.56
5	52	3.20

03.4188.CU.LE

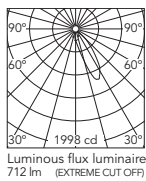

Beam Angle: 27°

h(m)	E(lx)	D(m)
1	1998	0.60
2	500	1.20
3	222	1.80
4	125	2.40
5	80	3.00

KAP

Kap 80/Kap 80 Plus - Square Wall-Washer

Light Source: Kap 80: LED Array DC 500 mA - 9,2W - 935 lm - 2700K/CRI 90 / 9,2W - 974 lm - 3000K/CRI 90
Kap 80 Plus: LED Array DC 700 mA - 13W - 1370 lm - 2700K/CRI 90 / 13W - 1460 lm - 3000K/CRI 90

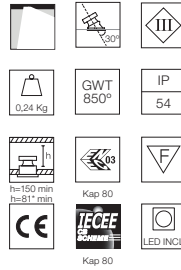
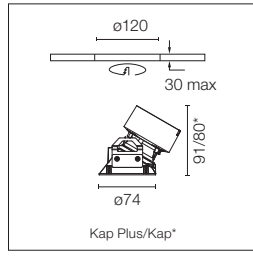

LED Einbauleuchte. Ohne Netzgerät. Recessed luminaire with LED light source. Elliptische linse enthalten. Power supply not included. Vorinstallationsrahmen. Muss Elliptical lens included. separat bestellt werden. Pre-installation frame. To be ordered separately.

Empfohlene Netzgeräte / Recommended power supply*:

	Kap 80	Kap 80 Plus
Non Dimmable	60.9160	60.9592
Dimmable 0/1-10V	60.9188	60.9188
Dimmable Dali 1	60.8847	60.8847
Dimmable Dali 2	60.9222	60.9222
Mains Dimming	60.9411	60.9467
Casambi	60.9207	60.9207

* Siehe Treiberkapitel / Refer to the Drivers chapter

2700K

- Kap 80
- 03.4191.B1
- Kap 80 Plus
- 05.7423.B1

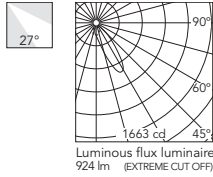

h(m)	E(lx)	D(m)
1	1663	0.62
2	416	1.24
3	185	1.85
4	104	2.47
5	67	3.09

3000K

- Kap 80
- 03.4190.B1
- Kap 80 Plus
- 05.7422.B1

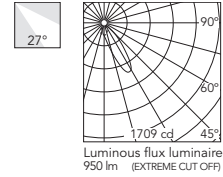

h(m)	E(lx)	D(m)
1	1709	0.62
2	427	1.24
3	190	1.85
4	107	2.47
5	68	3.09

- Kap 80
- 03.4191.GL
- Kap 80 Plus
- 05.7423.GL

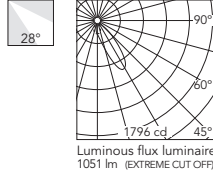

h(m)	E(lx)	D(m)
1	1796	0.68
2	449	1.36
3	200	2.04
4	112	2.72
5	72	3.40

- Kap 80
- 03.4190.GL
- Kap 80 Plus
- 05.7422.GL

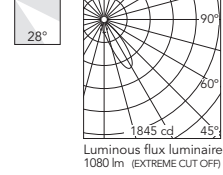

h(m)	E(lx)	D(m)
1	1845	0.68
2	461	1.36
3	205	2.04
4	115	2.72
5	74	3.40

- Kap 80
- 03.4191.BU
- Kap 80 Plus
- 05.7423.BU

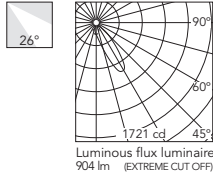

h(m)	E(lx)	D(m)
1	1721	0.63
2	430	1.25
3	191	1.88
4	108	2.51
5	69	3.14

- Kap 80
- 03.4190.BU
- Kap 80 Plus
- 05.7422.BU

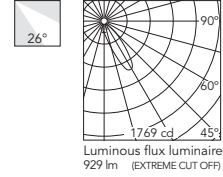

h(m)	E(lx)	D(m)
1	1769	0.63
2	442	1.25
3	197	1.88
4	111	2.51
5	71	3.14

- Kap 80
- 03.4191.74
- Kap 80 Plus
- 05.7423.74

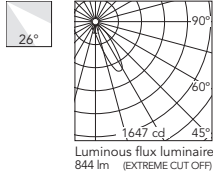

h(m)	E(lx)	D(m)
1	1647	0.59
2	412	1.19
3	183	1.78
4	103	2.37
5	66	2.97

- Kap 80
- 03.4190.74
- Kap 80 Plus
- 05.7422.74

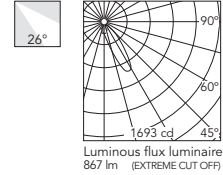

h(m)	E(lx)	D(m)
1	1693	0.59
2	423	1.19
3	188	1.78
4	106	2.37
5	68	2.97

- Kap 80
- 03.4191.CU
- Kap 80 Plus
- 05.7423.CU

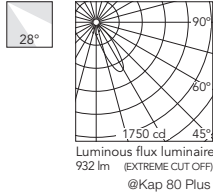

h(m)	E(lx)	D(m)
1	1750	0.64
2	437	1.29
3	194	1.93
4	109	2.57
5	70	3.21

- Kap 80
- 03.4190.CU
- Kap 80 Plus
- 05.7422.CU

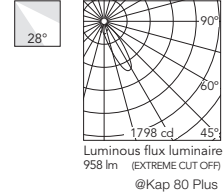

h(m)	E(lx)	D(m)
1	1798	0.64
2	450	1.29
3	200	1.93
4	112	2.57
5	72	3.21

Kap 80 Square Wall-Washer - Dim To Warm

Light Source: LED Array DC 300mA - 13W - max 940lm - 1800K - 2850K/CRI 95 - Dim To Warm

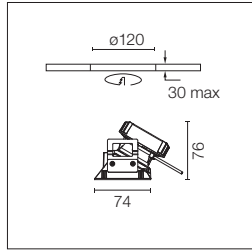

LED Einbauleuchte. 220-240V und dimmbares 1-10V Netzteil inklusive. Für Versionen mit 110-V-Geräten wenden Sie sich an das Frontoffice. Diffusorlinse inbegriffen. Vorinstallationsrahmen. Muss separat bestellt werden.

Recessed luminaire with LED light source. 220-240V & dimmable 1-10V power supply included. For 110V PSU versions, please consult with the front office. Diffusing lens included. Pre-installation frame. To be ordered separately.

1800K-2850K
 03.4190.B1.LE

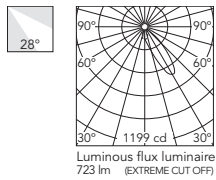

Beam Angle: 28°

h(m)	E(lx)	D(m)
1	1199	0.68
2	300	1.37
3	133	2.05
4	75	2.74
5	48	3.42

03.4190.GL.LE

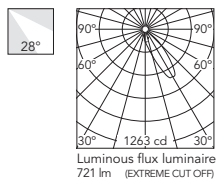

Beam Angle: 28°

h(m)	E(lx)	D(m)
1	1263	0.69
2	316	1.38
3	140	2.07
4	79	2.75
5	51	3.44

03.4190.BU.LE

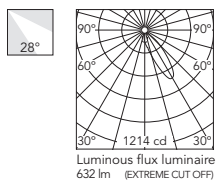

Beam Angle: 28°

h(m)	E(lx)	D(m)
1	1214	0.68
2	304	1.35
3	135	2.03
4	76	2.71
5	49	3.39

03.4190.74.LE

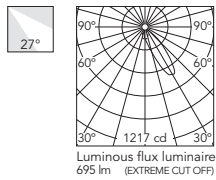

Beam Angle: 27°

h(m)	E(lx)	D(m)
1	1217	0.66
2	304	1.33
3	135	1.99
4	76	2.66
5	49	3.32

03.4190.CU.LE

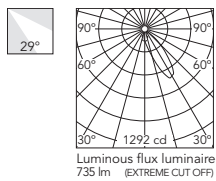

Beam Angle: 29°

h(m)	E(lx)	D(m)
1	1292	0.70
2	323	1.40
3	144	2.10
4	81	2.80
5	52	3.50

Kap Ø80 Wall-Washer

Light Source: LED QR-CBC 51 GX5.3

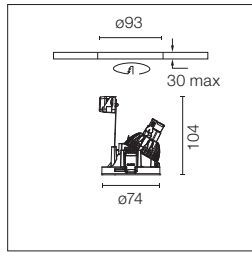

Einbauleuchte für 12V Lampe.
Separater Transformator nicht
inbegriffen.
Objektivzubehör nicht erhältlich.
Vorinstallationsrahmen. Muss
separat bestellt werden.

Recessed 12V lamp luminaire.
Remote transformer not included.
Not suitable for lens accessories.
Pre-installation frame. To be ordered
separately.

- 03.4244.B1
- 03.4244.GL
- 03.4244.BU
- 03.4244.74
- 03.4244.CU

Kap 80 Square Wall-Washer

Light Source: LED QR-CBC 51 GX5.3

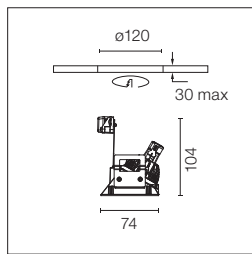

Einbauleuchte für 12V Lampe.
Separater Transformator nicht
inbegriffen.
Objektivzubehör nicht erhältlich.
Vorinstallationsrahmen. Muss
separat bestellt werden.

Recessed 12V lamp luminaire.
Remote transformer not included.
Not suitable for lens accessories.
Pre-installation frame. To be ordered
separately.

- 03.4242.B1
- 03.4242.GL
- 03.4242.BU
- 03.4242.74
- 03.4242.CU

Kap Ø80 Wall-Washer

Light Source: LED PAR 16 GZ10

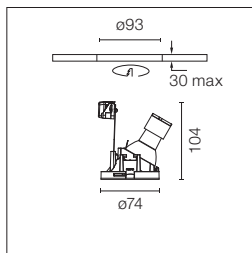

Einbauleuchte für Netzspannung.
Objektivzubehör nicht erhältlich.
Vorinstallationsrahmen. Muss
separat bestellt werden.

Recessed luminaire with main
voltage source.
Not suitable for lens accessories.
Pre-installation frame. To be ordered
separately.

- 03.4245.B1
- 03.4245.GL
- 03.4245.BU
- 03.4245.74
- 03.4245.CU

Kap 80 Square Wall-Washer

Light Source: LED PAR 16 GZ10

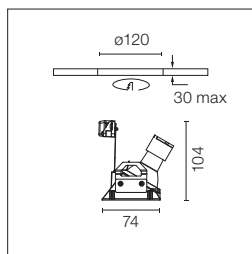

Einbauleuchte für Netzspannung.
Objektivzubehör nicht erhältlich.
Vorinstallationsrahmen. Muss
separat bestellt werden.

Recessed luminaire with main
voltage source.
Not suitable for lens accessories.
Pre-installation frame. To be ordered
separately.

- 03.4243.B1
- 03.4243.GL
- 03.4243.BU
- 03.4243.74
- 03.4243.CU

KAP

Kap 105 Square

Light Source: Phosphor LED 17W - 1400 lm - 2700K/CRI 98 / 17W - 1400 lm - 3000K/CRI 98

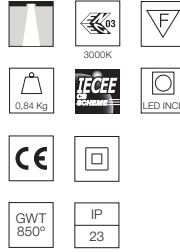
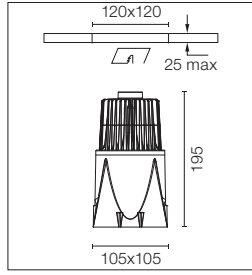

LED Einbauleuchte. Elektronischer Ferntransformator 220/240V inbegriffen.
Vorinstallationsrahmen. Muss separat bestellt werden.

Recessed luminaire with LED light source. Remote electronic transformer 220/240V included.
Pre-installation frame. To be ordered separately.

- 2700K**
Non Dimmable
- 03.4595.B1C
 - 03.4595.B1CDA
 - 1-10V
 - 03.4595.B1C1V

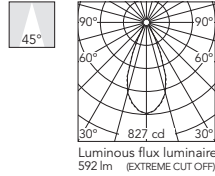

h(m)	E(lx)	D(m)
1	827	0.82
2	207	1.64
3	92	2.46
4	52	3.28
5	33	4.11

- 3000K**
Non Dimmable
- 03.4570.B1C
 - 03.4570.B1CDA
 - 1-10V
 - 03.4570.B1C1V

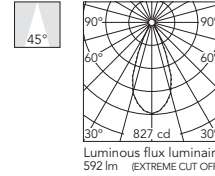

h(m)	E(lx)	D(m)
1	827	0.82
2	207	1.64
3	92	2.46
4	52	3.28
5	33	4.11

- Non Dimmable
- 03.4595.GLC
 - 03.4595.GLCDA
 - 1-10V
 - 03.4595.GLC1V

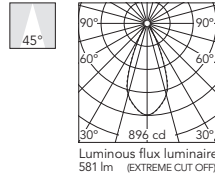

h(m)	E(lx)	D(m)
1	896	0.82
2	224	1.64
3	100	2.47
4	56	3.29
5	36	4.11

- Non Dimmable
- 03.4570.GLC
 - 03.4570.GLCDA
 - 1-10V
 - 03.4570.GLC1V

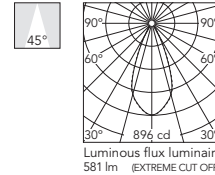

h(m)	E(lx)	D(m)
1	896	0.82
2	224	1.64
3	100	2.47
4	56	3.29
5	36	4.11

- Non Dimmable
- 03.4595.BUC
 - 03.4595.BUCDA
 - 1-10V
 - 03.4595.BUC1V

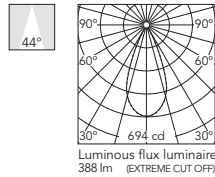

h(m)	E(lx)	D(m)
1	694	0.80
2	174	1.61
3	77	2.41
4	43	3.21
5	28	4.02

- Non Dimmable
- 03.4570.BUC
 - 03.4570.BUCDA
 - 1-10V
 - 03.4570.BUC1V

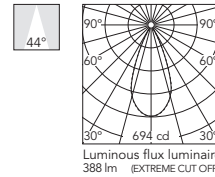

h(m)	E(lx)	D(m)
1	694	0.80
2	174	1.61
3	77	2.41
4	43	3.21
5	28	4.02

- Non Dimmable
- 03.4595.74C
 - 03.4595.74CDA
 - 1-10V
 - 03.4595.74C1V

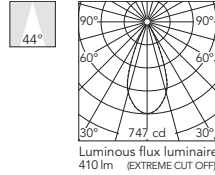

h(m)	E(lx)	D(m)
1	747	0.80
2	187	1.60
3	83	2.40
4	47	3.19
5	30	3.99

- Non Dimmable
- 03.4570.74C
 - 03.4570.74CDA
 - 1-10V
 - 03.4570.74C1V

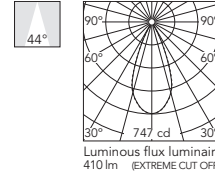

h(m)	E(lx)	D(m)
1	747	0.80
2	187	1.60
3	83	2.40
4	47	3.19
5	30	3.99

- Non Dimmable
- 03.4595.CUC
 - 03.4595.CUCDA
 - 1-10V
 - 03.4595.CUC1V

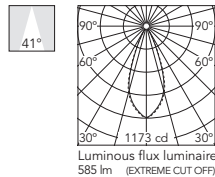

h(m)	E(lx)	D(m)
1	1173	0.74
2	293	1.48
3	130	2.22
4	73	2.96
5	47	3.69

- Non Dimmable
- 03.4570.CUC
 - 03.4570.CUCDA
 - 1-10V
 - 03.4570.CUC1V

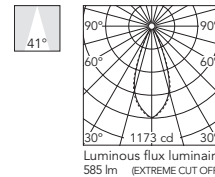

h(m)	E(lx)	D(m)
1	1173	0.74
2	293	1.48
3	130	2.22
4	73	2.96
5	47	3.69

KAP

Kap Ø105 Fixed - Optic Spot

Light Source: LED Array DC 650 mA - 23W - 2690 lm - 2700K/CRI 90 / 23W - 2870 lm - 3000K/CRI 90

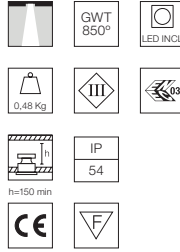
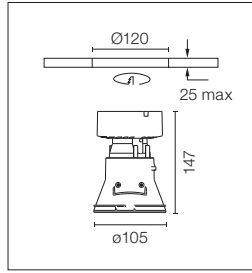

LED Einbauleuchte. Transformator nicht inbegriffen.
Diffusorlinse inbegriffen.
Vorinstallationsrahmen. Muss separat bestellt werden.

Recessed luminaire with LED light source. Remote transformer not included.
Diffusing lens included.
Pre-installation frame. To be ordered separately.

Empfohlene Netzgeräte / Recommended power supply*:

Non Dimmable	60.9592
Dimmable 1-10V	60.9439
Dimmable Dali 2	60.9186
Casambi	60.9207

* Siehe Treiberkapitel / Refer to the Drivers chapter

2700K

05.7100.B1

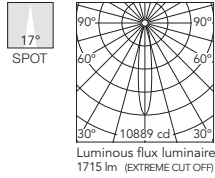

3000K

05.7105.B1

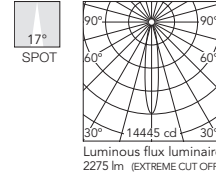

05.7100.GL

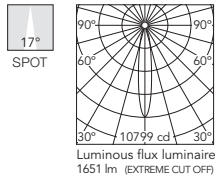

05.7105.GL

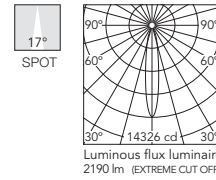

05.7100.BU

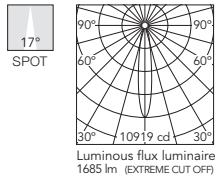

05.7105.BU

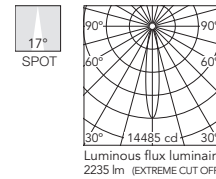

05.7100.74

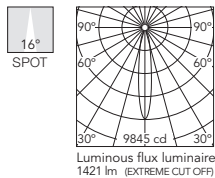

05.7105.74

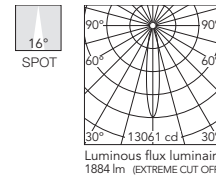

05.7100.CU

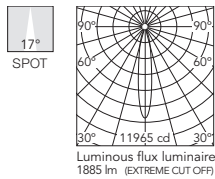

05.7105.CU

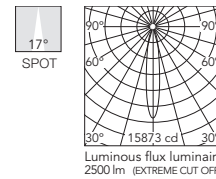

KAP

Kap Ø105 Fixed - Optic Medium

Light Source: LED Array DC 650 mA - 23W - 2690 lm - 2700K/CRI 90 / 23W - 2870 lm - 3000K/CRI 90

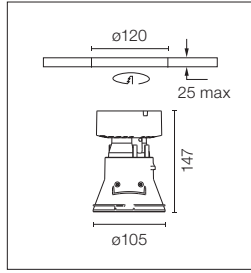

LED Einbauleuchte. Transformator nicht inbegriffen.
Diffusorlinse inbegriffen.
Vorinstallationsrahmen. Muss separat bestellt werden.

Recessed luminaire with LED light source. Remote transformer not included.
Diffusing lens included.
Pre-installation frame. To be ordered separately.

Empfohlene Netzgeräte / Recommended power supply*:

Non Dimmable	60.9592
Dimmable 1-10V	60.9439
Dimmable DALI 2	60.9186
Casambi	60.9207

* Siehe Treiberkapitel / Refer to the Drivers chapter

2700K

05.7101.B1

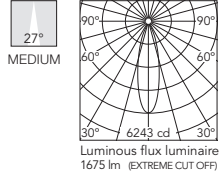

Beam Angle: 27°	h(m)	E(lx)	D(m)
1	6243	0.48	
2	1561	0.97	
3	694	1.45	
4	390	1.93	
5	250	2.41	

3000K

05.7106.B1

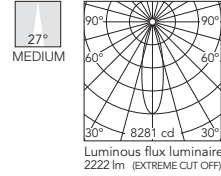

Beam Angle: 27°	h(m)	E(lx)	D(m)
1	8281	0.48	
2	2070	0.97	
3	920	1.45	
4	518	1.93	
5	331	2.41	

05.7101.GL

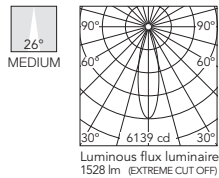

Beam Angle: 26°	h(m)	E(lx)	D(m)
1	6139	0.46	
2	1535	0.93	
3	682	1.39	
4	384	1.86	
5	246	2.32	

05.7106.GL

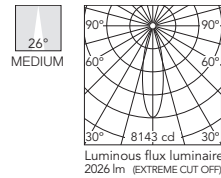

Beam Angle: 26°	h(m)	E(lx)	D(m)
1	8143	0.46	
2	2036	0.93	
3	905	1.39	
4	509	1.86	
5	326	2.32	

05.7101.BU

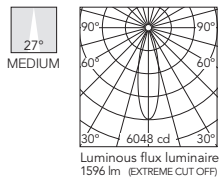

Beam Angle: 27°	h(m)	E(lx)	D(m)
1	6048	0.47	
2	1512	0.94	
3	672	1.41	
4	378	1.89	
5	242	2.36	

05.7106.BU

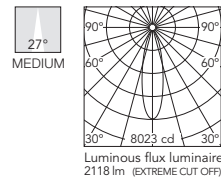

Beam Angle: 27°	h(m)	E(lx)	D(m)
1	8023	0.47	
2	2006	0.94	
3	891	1.41	
4	501	1.89	
5	321	2.36	

05.7101.74

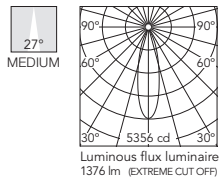

Beam Angle: 27°	h(m)	E(lx)	D(m)
1	5356	0.48	
2	1339	0.96	
3	595	1.44	
4	335	1.92	
5	214	2.40	

05.7106.74

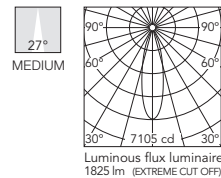

Beam Angle: 27°	h(m)	E(lx)	D(m)
1	7105	0.48	
2	1776	0.96	
3	789	1.44	
4	444	1.92	
5	284	2.40	

05.7101.CU

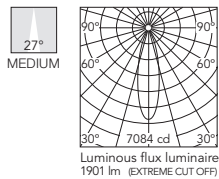

Beam Angle: 27°	h(m)	E(lx)	D(m)
1	7084	0.48	
2	1772	0.97	
3	787	1.45	
4	443	1.93	
5	283	2.41	

05.7106.CU

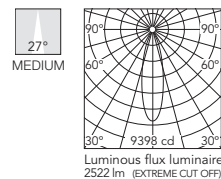

Beam Angle: 27°	h(m)	E(lx)	D(m)
1	9398	0.48	
2	2351	0.97	
3	1044	1.45	
4	588	1.93	
5	376	2.41	

KAP

Kap Ø105 Fixed - Optic Flood

Light Source: LED Array DC 650 mA - 23W - 2690 lm - 2700K/CRI 90 / 23W - 2870 lm - 3000K/CRI 90

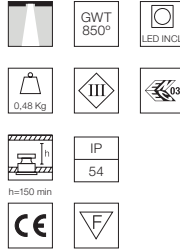
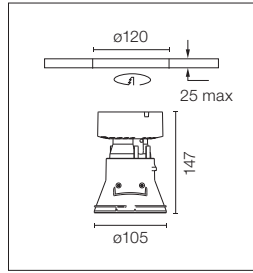

LED Einbauleuchte. Transformator nicht inbegriffen.
Diffusorlinse inbegriffen.
Vorinstallationsrahmen. Muss separat bestellt werden.

Recessed luminaire with LED light source. Remote transformer not included.
Diffuser lens included.
Pre-installation frame. To be ordered separately.

Empfohlene Netzgeräte / Recommended power supply*:

Non Dimmable	60.9592
Dimmable 1-10V	60.9439
Dimmable Dali 2	60.9186
Casambi	60.9207

* Siehe Treiberkapitel / Refer to the Drivers chapter

2700K
□ 05.7102.B1

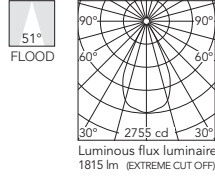

Beam Angle: 51°

h(m)	E(lx)	D(m)
1	2755	0.96
2	689	1.91
3	306	2.87
4	172	3.82
5	110	4.78

3000K
□ 05.7107.B1

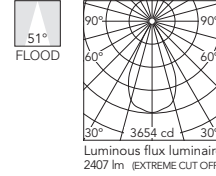

Beam Angle: 51°

h(m)	E(lx)	D(m)
1	3654	0.96
2	914	1.91
3	406	2.87
4	228	3.82
5	146	4.78

■ 05.7102.GL

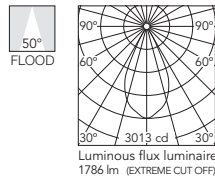

Beam Angle: 50°

h(m)	E(lx)	D(m)
1	3013	0.93
2	753	1.86
3	335	2.79
4	188	3.72
5	121	4.65

■ 05.7107.GL

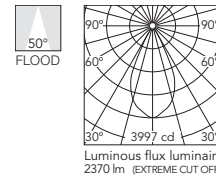

Beam Angle: 50°

h(m)	E(lx)	D(m)
1	3997	0.93
2	999	1.86
3	444	2.79
4	250	3.72
5	160	4.65

■ 05.7102.BU

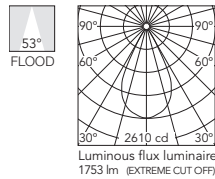

Beam Angle: 53°

h(m)	E(lx)	D(m)
1	2610	1.01
2	652	2.01
3	290	3.02
4	163	4.03
5	104	5.04

■ 05.7107.BU

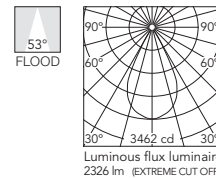

Beam Angle: 53°

h(m)	E(lx)	D(m)
1	3462	1.01
2	866	2.01
3	385	3.02
4	216	4.03
5	138	5.04

■ 05.7102.T4

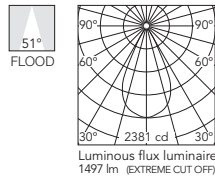

Beam Angle: 51°

h(m)	E(lx)	D(m)
1	2381	0.95
2	595	1.91
3	265	2.86
4	149	3.82
5	95	4.77

■ 05.7107.T4

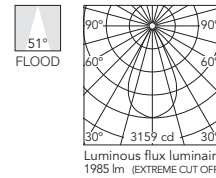

Beam Angle: 51°

h(m)	E(lx)	D(m)
1	3159	0.95
2	790	1.91
3	351	2.86
4	197	3.82
5	126	4.77

■ 05.7102.CU

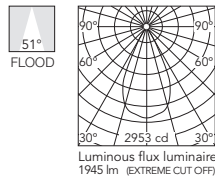

Beam Angle: 51°

h(m)	E(lx)	D(m)
1	2953	0.96
2	739	1.91
3	329	2.87
4	185	3.82
5	119	4.78

■ 05.7107.CU

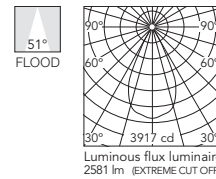

Beam Angle: 51°

h(m)	E(lx)	D(m)
1	3917	0.96
2	981	1.91
3	436	2.87
4	245	3.82
5	157	4.78

KAP

Kap 105 Square

Light Source: LED Array 17W - 1800 lm - 2700K/CRI 90 / 17W - 2000 lm - 3000K/CRI 90

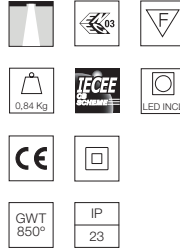
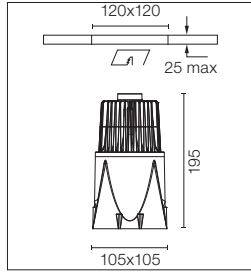

LED Einbauleuchte. Elektronischer Ferntransformator 220/240V inbegriffen.
Vorinstallationsrahmen. Muss separat bestellt werden.

Recessed luminaire with LED light source. Remote electronic transformer 220/240V included.
Pre-installation frame. To be ordered separately.

2700K

Non Dimmable

- 03.4583.B1
- Dali Version
- 03.4583.B1.DA
- 1-10V
- 03.4583.B1.1V

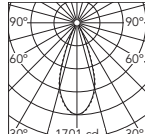

Beam Angle: 40°			
h(m)	E(lx)	D(m)	
1	1701	0.72	
2	425	1.44	
3	189	2.16	
4	106	2.87	
5	68	3.59	

Luminous flux luminaire
946 lm (EXTREME CUT OFF)

3000K

Non Dimmable

- 03.4582.B1
- Dali Version
- 03.4582.B1.DA
- 1-10V
- 03.4582.B1.1V

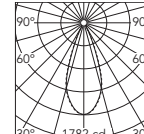

Beam Angle: 40°			
h(m)	E(lx)	D(m)	
1	1782	0.72	
2	446	1.44	
3	198	2.16	
4	111	2.87	
5	71	3.59	

Luminous flux luminaire
992 lm (EXTREME CUT OFF)

Non Dimmable

- 03.4583.GL
- Dali Version
- 03.4583.GL.DA
- 1-10V
- 03.4583.GL.1V

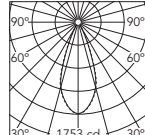

Beam Angle: 40°			
h(m)	E(lx)	D(m)	
1	1753	0.73	
2	438	1.46	
3	195	2.18	
4	110	2.91	
5	70	3.64	

Luminous flux luminaire
921 lm (EXTREME CUT OFF)

Non Dimmable

- 03.4582.GL
- Dali Version
- 03.4582.GL.DA
- 1-10V
- 03.4582.GL.1V

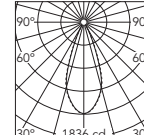

Beam Angle: 40°			
h(m)	E(lx)	D(m)	
1	1836	0.73	
2	459	1.46	
3	204	2.18	
4	115	2.91	
5	73	3.64	

Luminous flux luminaire
965 lm (EXTREME CUT OFF)

Non Dimmable

- 03.4583.BU
- Dali Version
- 03.4583.BU.DA
- 1-10V
- 03.4583.BU.1V

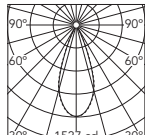

Beam Angle: 40°			
h(m)	E(lx)	D(m)	
1	1527	0.72	
2	382	1.44	
3	170	2.16	
4	95	2.88	
5	61	3.60	

Luminous flux luminaire
708 lm (EXTREME CUT OFF)

Non Dimmable

- 03.4582.BU
- Dali Version
- 03.4582.BU.DA
- 1-10V
- 03.4582.BU.1V

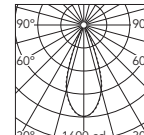

Beam Angle: 40°			
h(m)	E(lx)	D(m)	
1	1600	0.72	
2	400	1.44	
3	178	2.16	
4	100	2.88	
5	64	3.60	

Luminous flux luminaire
742 lm (EXTREME CUT OFF)

Non Dimmable

- 03.4583.74
- Dali Version
- 03.4583.74.DA
- 1-10V
- 03.4583.74.1V

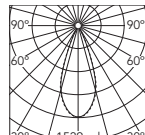

Beam Angle: 40°			
h(m)	E(lx)	D(m)	
1	1529	0.72	
2	382	1.44	
3	170	2.16	
4	96	2.88	
5	61	3.60	

Luminous flux luminaire
703 lm (EXTREME CUT OFF)

Non Dimmable

- 03.4582.74
- Dali Version
- 03.4582.74.DA
- 1-10V
- 03.4582.74.1V

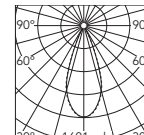

Beam Angle: 40°			
h(m)	E(lx)	D(m)	
1	1601	0.72	
2	400	1.44	
3	178	2.16	
4	100	2.88	
5	64	3.60	

Luminous flux luminaire
736 lm (EXTREME CUT OFF)

Non Dimmable

- 03.4583.CU
- Dali Version
- 03.4583.CU.DA
- 1-10V
- 03.4583.CU.1V

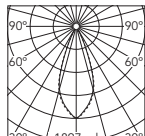

Beam Angle: 40°			
h(m)	E(lx)	D(m)	
1	1897	0.72	
2	474	1.44	
3	211	2.16	
4	119	2.88	
5	76	3.60	

Luminous flux luminaire
882 lm (EXTREME CUT OFF)

Non Dimmable

- 03.4582.CU
- Dali Version
- 03.4582.CU.DA
- 1-10V
- 03.4582.CU.1V

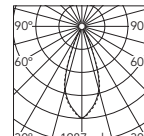

Beam Angle: 40°			
h(m)	E(lx)	D(m)	
1	1987	0.72	
2	497	1.44	
3	221	2.16	
4	124	2.88	
5	79	3.60	

Luminous flux luminaire
924 lm (EXTREME CUT OFF)

KAP

Kap 105 Square

Light Source: LED QR-CBC 51 GX5.3

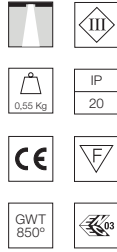
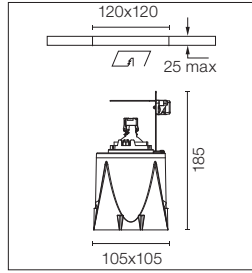

Einbauleuchte für 12V lampe.
Separater Transformator nicht
inbegriffen.
Objektivzubehör nicht erhältlich.
Vorinstallationsrahmen. Muss
separat bestellt werden.

Recessed 12V lamp luminaire.
Remote transformer not included.
Not suitable for lens accessories.
Pre-installation frame. To be ordered
separately.

- 03.4572.B1
- 03.4572.GL
- 03.4572.BU
- 03.4572.74
- 03.4572.CU

Kap Ø105 Fixed

Light Source: LED QR-CBC 51 GX5.3

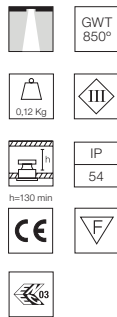
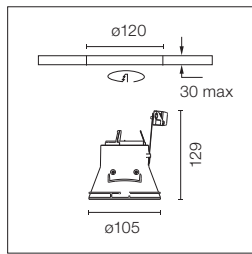

Einbauleuchte für 12V lampe.
Separater Transformator nicht
inbegriffen.
Objektivzubehör nicht erhältlich.
Vorinstallationsrahmen. Muss
separat bestellt werden.

Recessed 12V lamp luminaire.
Remote transformer not included.
Not suitable for lens accessories.
Pre-installation frame. To be ordered
separately.

- 05.7130.B1
- 05.7130.GL
- 05.7130.BU
- 05.7130.74
- 05.7130.CU

Kap Ø105 Fixed

Light Source: LED PAR 16 GZ10

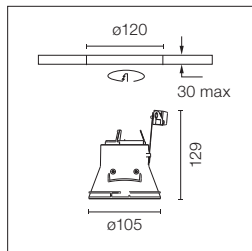

Einbauleuchte für Netzspannung.
Objektivzubehör nicht erhältlich.
Vorinstallationsrahmen. Muss
separat bestellt werden.

Recessed luminaire with main
voltage source.
Not suitable for lens accessories.
Pre-installation frame. To be ordered
separately.

- 05.7131.B1
- 05.7131.GL
- 05.7131.BU
- 05.7131.74
- 05.7131.CU

KAP

Kap Ø105 Adjustable - Optic Spot

Light Source: LED Array DC 650 mA - 23W - 2690 lm - 2700K/CRI 90 / 23W - 2870 lm - 3000K/CRI 90

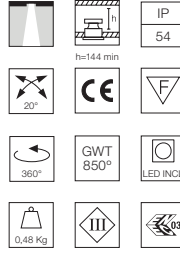
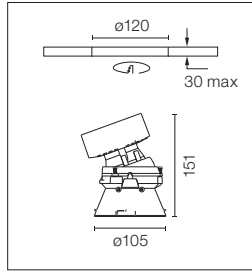

LED Einbauleuchte. Transformator nicht inbegriffen.
Diffusorlinse inbegriffen.
Vorinstallationsrahmen. Muss separat bestellt werden.

Recessed luminaire with LED light source. Remote transformer not included.
Diffusing lens included.
Pre-installation frame. To be ordered separately.

Empfohlene Netzgeräte / Recommended power supply*:

Non Dimmable	60.9592
Dimmable 1-10V	60.9439
Dimmable Dali 2	60.9186
Casambi	60.9207

* Siehe Treiberkapitel / Refer to the Drivers chapter

2700K
□ 05.7110.B1

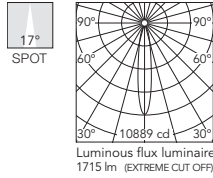

Beam Angle: 17°

h(m)	E(lx)	D(m)
1	10889	0.30
2	2722	0.59
3	1210	0.89
4	681	1.18
5	436	1.48

3000K
□ 05.7115.B1

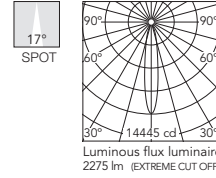

Beam Angle: 17°

h(m)	E(lx)	D(m)
1	14445	0.30
2	3611	0.59
3	1605	0.89
4	903	1.18
5	578	1.48

■ 05.7110.GL

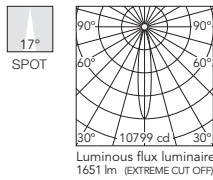

Beam Angle: 17°

h(m)	E(lx)	D(m)
1	10799	0.29
2	2700	0.59
3	1200	0.88
4	675	1.17
5	432	1.47

■ 05.7115.GL

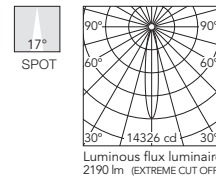

Beam Angle: 17°

h(m)	E(lx)	D(m)
1	14326	0.29
2	3581	0.59
3	1592	0.88
4	895	1.17
5	573	1.47

■ 05.7110.BU

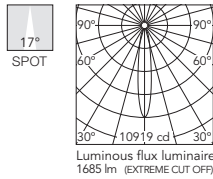

Beam Angle: 17°

h(m)	E(lx)	D(m)
1	10919	0.29
2	2730	0.59
3	1213	0.88
4	682	1.18
5	437	1.47

■ 05.7115.BU

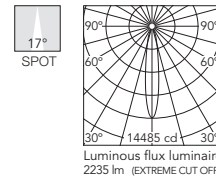

Beam Angle: 17°

h(m)	E(lx)	D(m)
1	14485	0.29
2	3621	0.59
3	1609	0.88
4	905	1.18
5	579	1.47

■ 05.7110.74

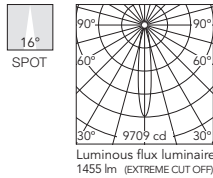

Beam Angle: 16°

h(m)	E(lx)	D(m)
1	9709	0.29
2	2427	0.57
3	1079	0.86
4	607	1.15
5	388	1.43

■ 05.7115.74

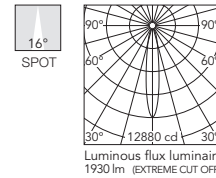

Beam Angle: 16°

h(m)	E(lx)	D(m)
1	12880	0.29
2	3220	0.57
3	1431	0.86
4	805	1.15
5	515	1.43

■ 05.7110.CU

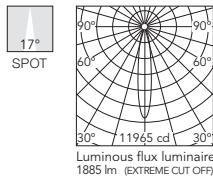

Beam Angle: 17°

h(m)	E(lx)	D(m)
1	11965	0.30
2	2991	0.59
3	1329	0.89
4	748	1.18
5	479	1.48

■ 05.7115.CU

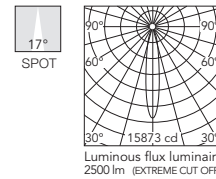

Beam Angle: 17°

h(m)	E(lx)	D(m)
1	15873	0.30
2	3968	0.59
3	1763	0.89
4	993	1.18
5	635	1.48

KAP

Kap Ø105 Adjustable - Optic Medium

Light Source: LED Array DC 650 mA - 23W - 2690 lm - 2700K/CRI 90 / 23W - 2870 lm - 3000K/CRI 90

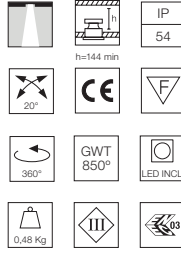
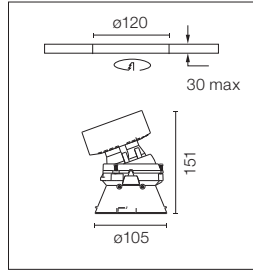

LED Einbauleuchte. Transformator nicht inbegriffen.
Diffusorlinse inbegriffen.
Vorinstallationsrahmen. Muss separat bestellt werden.

Recessed luminaire with LED light source. Remote transformer not included.
Diffusing lens included.
Pre-installation frame. To be ordered separately.

Empfohlene Netzgeräte / Recommended power supply*:
Non Dimmable 60.9592
Dimmable 1-10V 60.9439
Dimmable Dali 2 60.9186
Casambi 60.9207

* Siehe Treiberkapitel / Refer to the Drivers chapter

2700K
□ 05.7111.B1

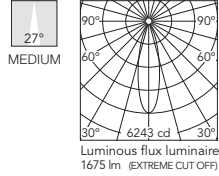

Beam Angle: 27°	h(m)	E(lx)	D(m)
1	6243	0.48	
2	1561	0.97	
3	694	1.45	
4	390	1.93	
5	250	2.41	

3000K
□ 05.7116.B1

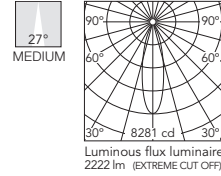

Beam Angle: 27°	h(m)	E(lx)	D(m)
1	8281	0.48	
2	2070	0.97	
3	920	1.45	
4	518	1.93	
5	331	2.41	

■ 05.7111.GL

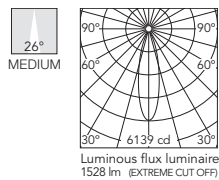

Beam Angle: 26°	h(m)	E(lx)	D(m)
1	6139	0.46	
2	1535	0.93	
3	682	1.39	
4	384	1.86	
5	246	2.32	

■ 05.7116.GL

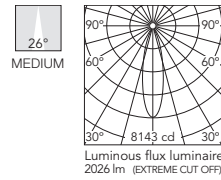

Beam Angle: 26°	h(m)	E(lx)	D(m)
1	8143	0.46	
2	2036	0.93	
3	905	1.39	
4	509	1.86	
5	326	2.32	

■ 05.7111.BU

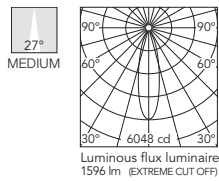

Beam Angle: 27°	h(m)	E(lx)	D(m)
1	6048	0.47	
2	1512	0.94	
3	672	1.41	
4	378	1.89	
5	242	2.36	

■ 05.7116.BU

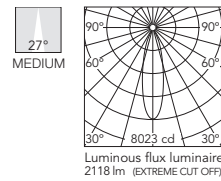

Beam Angle: 27°	h(m)	E(lx)	D(m)
1	8023	0.47	
2	2006	0.94	
3	891	1.41	
4	501	1.89	
5	321	2.36	

■ 05.7111.74

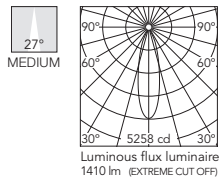

Beam Angle: 27°	h(m)	E(lx)	D(m)
1	5258	0.48	
2	1314	0.96	
3	584	1.44	
4	329	1.92	
5	210	2.40	

■ 05.7116.74

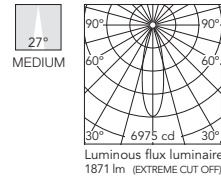

Beam Angle: 27°	h(m)	E(lx)	D(m)
1	6975	0.48	
2	1744	0.96	
3	775	1.44	
4	436	1.92	
5	279	2.40	

■ 05.7111.CU

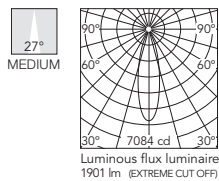

Beam Angle: 27°	h(m)	E(lx)	D(m)
1	7084	0.48	
2	1772	0.97	
3	787	1.45	
4	443	1.93	
5	283	2.41	

■ 05.7116.CU

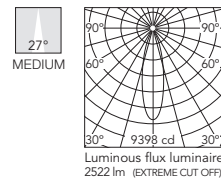

Beam Angle: 27°	h(m)	E(lx)	D(m)
1	9398	0.48	
2	2351	0.97	
3	1044	1.45	
4	588	1.93	
5	376	2.41	

KAP

Kap Ø105 Adjustable - Optic Flood

Light Source: LED Array DC 650 mA - 23W - 2690 lm - 2700K/CRI 90 / 23W - 2870 lm - 3000K/CRI 90

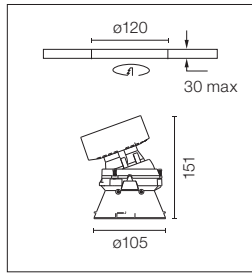

LED Einbauleuchte. Transformator nicht inbegriffen.
Diffusorlinse inbegriffen.
Vorinstallationsrahmen. Muss separat bestellt werden.

Recessed luminaire with LED light source. Remote transformer not included.
Diffusing lens included.
Pre-installation frame. To be ordered separately.

Empfohlene Netzgeräte / Recommended power supply*:
Non Dimmable 60.9592
Dimmable 1-10V 60.9439
Dimmable Dali 2 60.9186
Casambi 60.9207

* Siehe Treiberkapitel / Refer to the Drivers chapter

2700K
□ 05.7112.B1

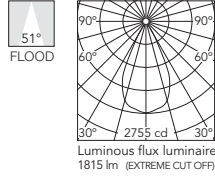

3000K
□ 05.7117.B1

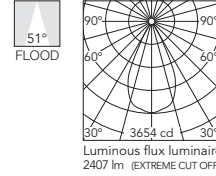

■ 05.7112.GL

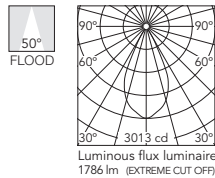

■ 05.7117.GL

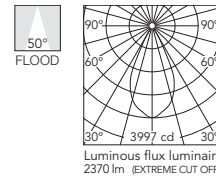

■ 05.7112.BU

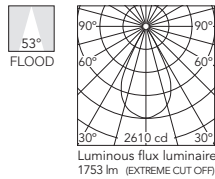

■ 05.7117.BU

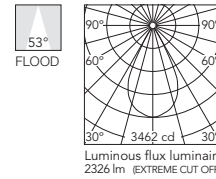

■ 05.7112.74

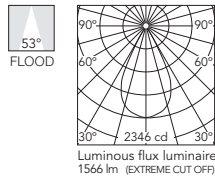

■ 05.7117.74

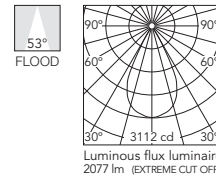

■ 05.7112.CU

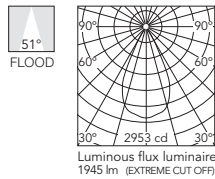

■ 05.7117.CU

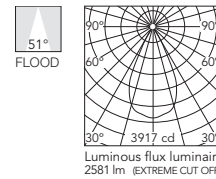

KAP

Kap Ø105 Adjustable

Light Source: LED QR-CBC 51 GX5.3

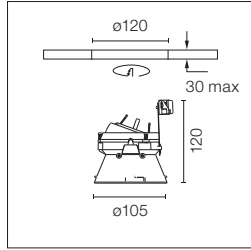

		IP 54
	GWT 850°	

Einbauleuchte für 12V lampe.
Separater Transformator nicht
inbegriffen.
Objektivzubehör nicht erhältlich.
Vorinstallationsrahmen. Muss
separat bestellt werden.

Recessed 12V lamp luminaire.
Remote transformer not included.
Not suitable for lens accessories.
Pre-installation frame. To be ordered
separately.

- 05.7135.B1
- 05.7135.GL
- 05.7135.BU
- 05.7135.74
- 05.7135.CU

Kap Ø105 Adjustable

Light Source: LED PAR 16 GZ10

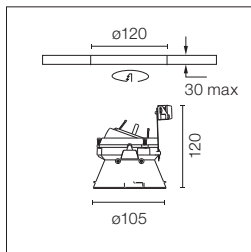

		IP 54
	GWT 850°	

Einbauleuchte für Netzspannung.
Objektivzubehör nicht erhältlich.
Vorinstallationsrahmen. Muss
separat bestellt werden.

Recessed luminaire with main
voltage source.
Not suitable for lens accessories.
Pre-installation frame. To be ordered
separately.

- 05.7136.B1
- 05.7136.GL
- 05.7136.BU
- 05.7136.74
- 05.7136.CU

KAP

Kap Ø105 Wall-Washer

Light Source: LED Array DC 650 mA - 23W - 2690 lm - 2700K/CRI 90 / 23W - 2870 lm - 3000K/CRI 90

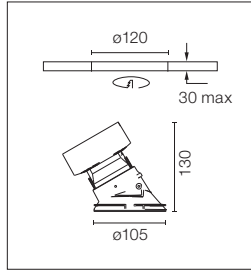

LED Einbauleuchte. Elektronischer Ferntransformator 220/240V nicht inbegriffen.
Vorinstallationsrahmen. Muss separat bestellt werden.

Recessed luminaire with LED light source. Remote electronic transformer 220/240V not included.
Pre-installation frame. To be ordered separately.

Empfohlene Netzgeräte / Recommended power supply*:

Non Dimmable	60.9592
Dimmable 1-10V	60.9439
Dimmable DALI 2	60.9186
Casambi	60.9207

* Siehe Treiberkapitel / Refer to the Drivers chapter

2700K
□ 05.7120.B1

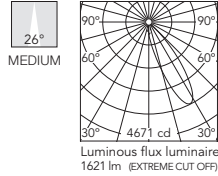

3000K
□ 05.7121.B1

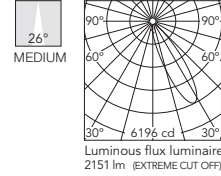

■ 05.7120.GL

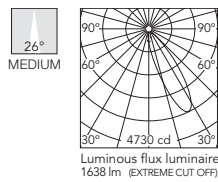

■ 05.7121.GL

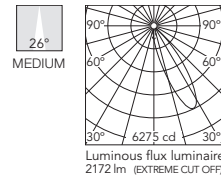

■ 05.7120.BU

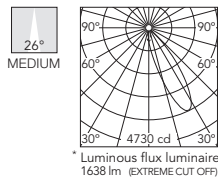

■ 05.7121.BU

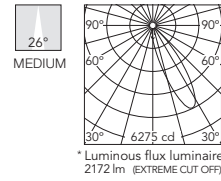

■ 05.7120.74

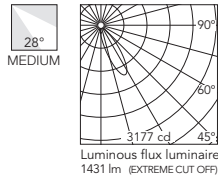

■ 05.7121.74

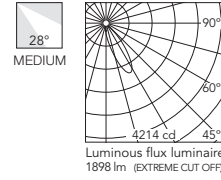

■ 05.7120.CU

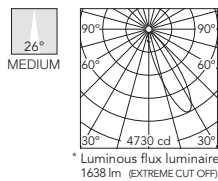

■ 05.7121.CU

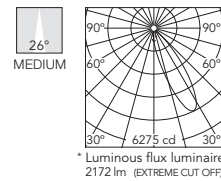

* Vorläufige Photometrien. Aktuelle Informationen finden Sie auf unserer Website / Preliminary photometries. Visit our website for updated information.



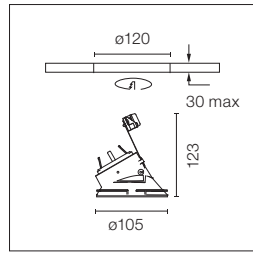

Kap Ø105 Wall-Washer

Light Source: LED QR-CBC 51 GX5.3



Einbauleuchte für 12V LEDlampe.
Separater Transformator nicht
inbegriffen.
Objektivzubehör nicht erhältlich.
Vorinstallationsrahmen. Muss
separat bestellt werden.

Recessed 12V LED lamp luminaire.
Remote transformer not included.
Not suitable for lens accessories.
Pre-installation frame. To be ordered
separately.

-  05.7140.B1
-  05.7140.GL
-  05.7140.BU
-  05.7140.74
-  05.7140.CU



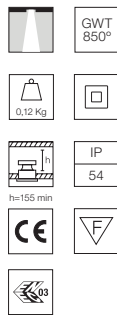
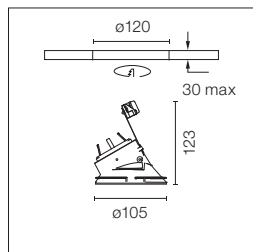

Kap Ø105 Wall-Washer

Light Source: LED PAR 16 GZ10



Einbauleuchte für Netzspannung.
Objektivzubehör nicht erhältlich.
Vorinstallationsrahmen. Muss
separat bestellt werden.

Recessed luminaire with main
voltage source.
Not suitable for lens accessories.
Pre-installation frame. To be ordered
separately.

-  05.7141.B1
-  05.7141.GL
-  05.7141.BU
-  05.7141.74
-  05.7141.CU

KAP

Kap Ø105 Deep - Optic Spot

Light Source: LED Array DC 650 mA - 23W - 2690 lm - 2700K/CRI 90 / 23W - 2870 lm - 3000K/CRI 90

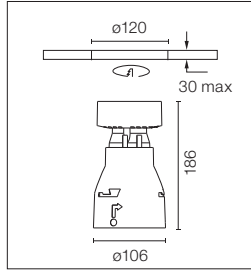

LED Einbauleuchte. Elektronischer Ferntransformator 220/240V nicht inbegriffen.
Vorinstallationsrahmen. Muss separat bestellt werden.

Recessed luminaire with LED light source. Remote electronic transformer 220/240V not included.
Pre-installation frame. To be ordered separately.

Empfohlene Netzgeräte / Recommended power supply*:

Non Dimmable	60.9592
Dimmable 1-10V	60.9439
Dimmable Dali 2	60.9186
Casambi	60.9207

* Siehe Treiberkapitel / Refer to the Drivers chapter

2700K
□ 05.7150.B1

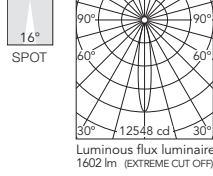

3000K
□ 05.7155.B1

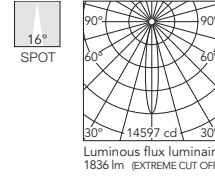

■ 05.7150.GL

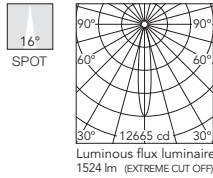

■ 05.7155.GL

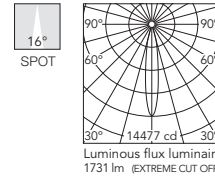

■ 05.7150.BU

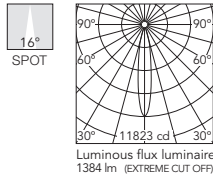

■ 05.7155.BU

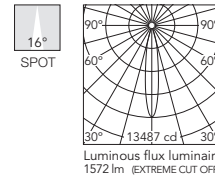

■ 05.7150.74

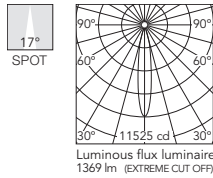

■ 05.7155.74

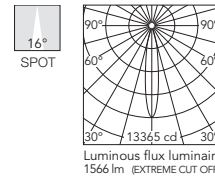

■ 05.7150.CU

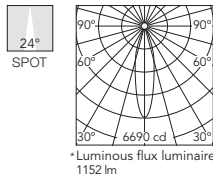

■ 05.7155.CU

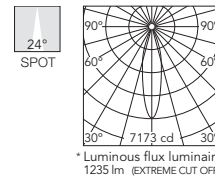

* Vorläufige Photometrien. Aktuelle Informationen finden Sie auf unserer Website / Preliminary photometries. Visit our website for updated information.

KAP

Kap Ø105 Deep - Optic Medium

Light Source: LED Array DC 650 mA - 23W - 2690 lm - 2700K/CRI 90 / 23W - 2870 lm - 3000K/CRI 90

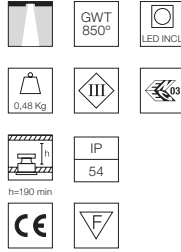
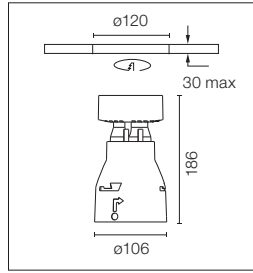

LED Einbauleuchte. Elektronischer Ferntransformator 220/240V nicht inbegriffen.
Vorinstallationsrahmen. Muss separat bestellt werden.

Recessed luminaire with LED light source. Remote electronic transformer 220/240V not included.
Pre-installation frame. To be ordered separately.

Empfohlene Netzgeräte / Recommended power supply*:

Non Dimmable	60.9592
Dimmable 1-10V	60.9439
Dimmable DALI 2	60.9186
Casambi	60.9207

* Siehe Treiberkapitel / Refer to the Drivers chapter

2700K
05.7151.B1

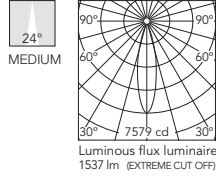

Beam Angle: 24°

h(m)	E(lx)	D(m)
1	7579	0.42
2	1895	0.84
3	842	1.26
4	474	1.69
5	303	2.11

3000K
05.7156.B1

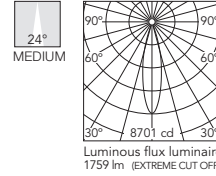

Beam Angle: 24°

h(m)	E(lx)	D(m)
1	8701	0.42
2	2175	0.84
3	967	1.26
4	544	1.68
5	348	2.10

05.7151.GL

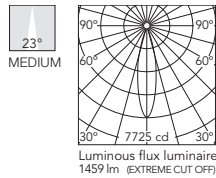

Beam Angle: 23°

h(m)	E(lx)	D(m)
1	7725	0.42
2	1931	0.83
3	858	1.25
4	483	1.66
5	309	2.08

05.7156.GL

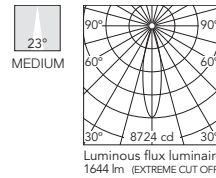

Beam Angle: 23°

h(m)	E(lx)	D(m)
1	8724	0.42
2	2181	0.83
3	969	1.25
4	545	1.66
5	349	2.08

05.7151.BU

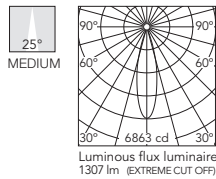

Beam Angle: 25°

h(m)	E(lx)	D(m)
1	6863	0.45
2	1716	0.90
3	763	1.35
4	429	1.79
5	275	2.24

05.7156.BU

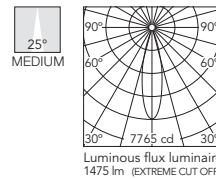

Beam Angle: 25°

h(m)	E(lx)	D(m)
1	7765	0.45
2	1941	0.89
3	863	1.34
4	485	1.79
5	311	2.23

05.7151.74

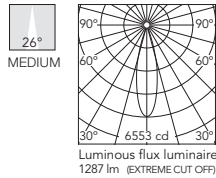

Beam Angle: 26°

h(m)	E(lx)	D(m)
1	6553	0.46
2	1638	0.93
3	728	1.39
4	410	1.85
5	262	2.31

05.7156.74

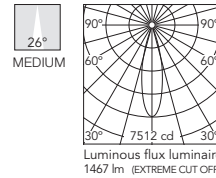

Beam Angle: 26°

h(m)	E(lx)	D(m)
1	7512	0.46
2	1878	0.92
3	835	1.38
4	469	1.85
5	300	2.31

05.7151.CU

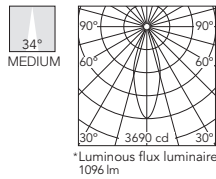

Beam Angle: 34°

h(m)	E(lx)	D(m)
1	3690	0.61
2	923	1.23
3	410	1.84
4	231	2.45
5	148	3.06

05.7156.CU

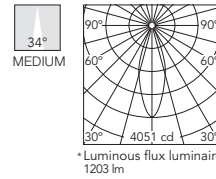

Beam Angle: 34°

h(m)	E(lx)	D(m)
1	4051	0.61
2	1013	1.23
3	450	1.84
4	253	2.45
5	162	3.06

* Vorläufige Photometrien. Aktuelle Informationen finden Sie auf unserer Website / Preliminary photometries. Visit our website for updated information.

KAP

Kap Ø105 Deep - Optic Flood

Light Source: LED Array DC 650 mA - 23W - 2690 lm - 2700K/CRI 90 / 23W - 2870 lm - 3000K/CRI 90

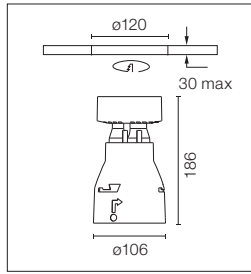

LED Einbauleuchte. Elektronischer Ferntransformator 220/240V nicht inbegriffen.
Vorinstallationsrahmen. Muss separat bestellt werden.

Recessed luminaire with LED light source. Remote electronic transformer 220/240V not included.
Pre-installation frame. To be ordered separately.

Empfohlene Netzgeräte / Recommended power supply*:

Non Dimmable	60.9592
Dimmable 1-10V	60.9439
Dimmable Dali 2	60.9186
Casambi	60.9207

* Siehe Treiberkapitel / Refer to the Drivers chapter

2700K
□ 05.7152.B1

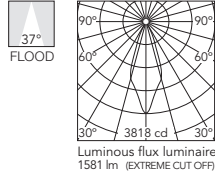

Beam Angle: 37°

h(m)	E(lx)	D(m)
1	3818	0.68
2	954	1.36
3	424	2.03
4	239	2.71
5	153	3.39

3000K
□ 05.7157.B1

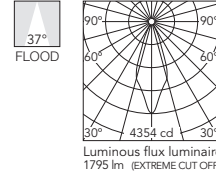

Beam Angle: 37°

h(m)	E(lx)	D(m)
1	4354	0.68
2	1089	1.35
3	484	2.03
4	272	2.71
5	174	3.38

■ 05.7152.GL

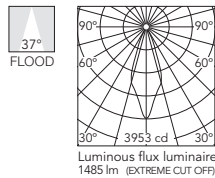

Beam Angle: 37°

h(m)	E(lx)	D(m)
1	3953	0.67
2	988	1.34
3	439	2.01
4	247	2.68
5	158	3.35

■ 05.7157.GL

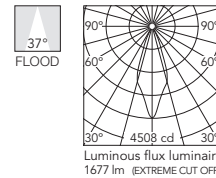

Beam Angle: 37°

h(m)	E(lx)	D(m)
1	4508	0.67
2	1127	1.33
3	501	2.00
4	282	2.67
5	180	3.34

■ 05.7152.BU

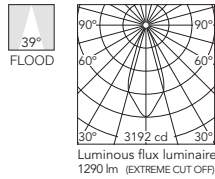

Beam Angle: 39°

h(m)	E(lx)	D(m)
1	3192	0.71
2	798	1.42
3	355	2.13
4	199	2.84
5	128	3.55

■ 05.7157.BU

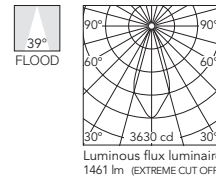

Beam Angle: 39°

h(m)	E(lx)	D(m)
1	3630	0.71
2	907	1.42
3	403	2.13
4	227	2.84
5	145	3.55

■ 05.7152.74

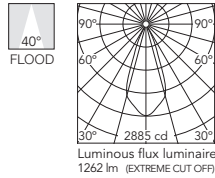

Beam Angle: 40°

h(m)	E(lx)	D(m)
1	2885	0.73
2	721	1.46
3	321	2.19
4	180	2.92
5	115	3.65

■ 05.7157.74

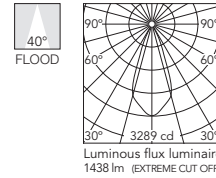

Beam Angle: 40°

h(m)	E(lx)	D(m)
1	3289	0.73
2	822	1.46
3	365	2.19
4	206	2.92
5	132	3.65

■ 05.7152.CU

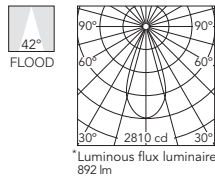

Beam Angle: 42°

h(m)	E(lx)	D(m)
1	2810	0.77
2	702	1.53
3	312	2.30
4	176	3.07
5	112	3.83

■ 05.7157.CU

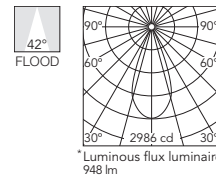

Beam Angle: 42°

h(m)	E(lx)	D(m)
1	2986	0.77
2	747	1.53
3	332	2.30
4	187	3.07
5	119	3.83

* Vorläufige Photometrien. Aktuelle Informationen finden Sie auf unserer Website / Preliminary photometries. Visit our website for updated information.

KAP

Kap Ø145

Light Source: Phosphor LED 17W - 1400 lm - 2700K/CRI 98 / 17W - 1400 lm - 3000K/CRI 98

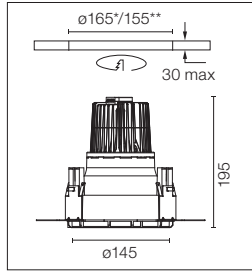

* No Trim | ** Trim

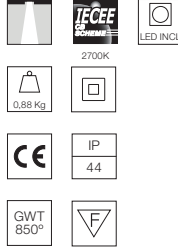

LED Einbauleuchte. Elektronischer Ferntransformator 220/240V inbegriffen. Vorinstallationsrahmen. Muss separat bestellt werden.

Recessed luminaire with LED light source. Remote electronic transformer 220/240V included. Pre-installation frame. To be ordered separately.

2700K

Non Dimmable

- 03.4496.B1B
- Dali Version
- 03.4496.B1BDA
- 1-10V
- 03.4496.B1B1V

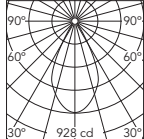

h(m)	E(lx)	D(m)
1	928	1.00
2	232	2.00
3	103	3.00
4	58	4.01
5	37	5.01

Luminous flux luminaire 775 lm (EXTREME CUT OFF)

3000K

Non Dimmable

- 03.4420.B1C
- Dali Version
- 03.4420.B1CDA
- 1-10V
- 03.4420.B1C1V

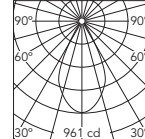

h(m)	E(lx)	D(m)
1	961	1.00
2	240	2.00
3	107	3.00
4	60	4.01
5	38	5.01

Luminous flux luminaire 803 lm (EXTREME CUT OFF)

Non Dimmable

- 03.4496.GLB
- Dali Version
- 03.4496.GLBDA
- 1-10V
- 03.4496.GLB1V

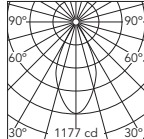

h(m)	E(lx)	D(m)
1	1177	0.92
2	294	1.84
3	131	2.76
4	74	3.68
5	47	4.60

Luminous flux luminaire 760 lm (EXTREME CUT OFF)

Non Dimmable

- 03.4420.GLC
- Dali Version
- 03.4420.GLCDA
- 1-10V
- 03.4420.GLC1V

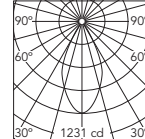

h(m)	E(lx)	D(m)
1	1231	0.92
2	308	1.84
3	137	2.76
4	77	3.68
5	49	4.60

Luminous flux luminaire 796 lm (EXTREME CUT OFF)

Non Dimmable

- 03.4496.BUB
- Dali Version
- 03.4496.BUBDA
- 1-10V
- 03.4496.BUB1V

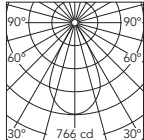

h(m)	E(lx)	D(m)
1	766	1.02
2	191	2.04
3	85	3.06
4	48	4.08
5	31	5.11

Luminous flux luminaire 550 lm (EXTREME CUT OFF)

Non Dimmable

- 03.4420.BUC
- Dali Version
- 03.4420.BUCDA
- 1-10V
- 03.4420.BUC1V

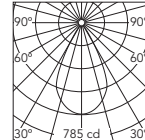

h(m)	E(lx)	D(m)
1	785	1.02
2	196	2.04
3	87	3.06
4	49	4.08
5	31	5.11

Luminous flux luminaire 563 lm (EXTREME CUT OFF)

Non Dimmable

- 03.4496.74B
- Dali Version
- 03.4496.74BDA
- 1-10V
- 03.4496.74B1V

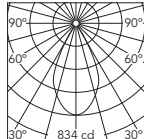

h(m)	E(lx)	D(m)
1	834	0.97
2	208	1.95
3	93	2.92
4	52	3.90
5	33	4.87

Luminous flux luminaire 541 lm (EXTREME CUT OFF)

Non Dimmable

- 03.4420.74C
- Dali Version
- 03.4420.74CDA
- 1-10V
- 03.4420.74C1V

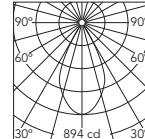

h(m)	E(lx)	D(m)
1	894	0.97
2	224	1.95
3	99	2.92
4	56	3.90
5	36	4.87

Luminous flux luminaire 580 lm (EXTREME CUT OFF)

Non Dimmable

- 03.4496.CUB
- Dali Version
- 03.4496.CUBDA
- 1-10V
- 03.4496.CUB1V

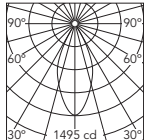

h(m)	E(lx)	D(m)
1	1495	0.83
2	374	1.66
3	166	2.49
4	93	3.33
5	60	4.16

Luminous flux luminaire 796 lm (EXTREME CUT OFF)

Non Dimmable

- 03.4420.CUC
- Dali Version
- 03.4420.CUCDA
- 1-10V
- 03.4420.CUC1V

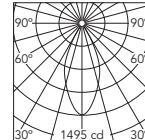

h(m)	E(lx)	D(m)
1	1495	0.83
2	374	1.66
3	166	2.49
4	93	3.33
5	60	4.16

Luminous flux luminaire 796 lm (EXTREME CUT OFF)

KAP

Kap Ø145

Light Source: LED Array 17W - 1800 lm - 2700K/CRI 90 / 17W - 2000 lm - 3000K/CRI 90

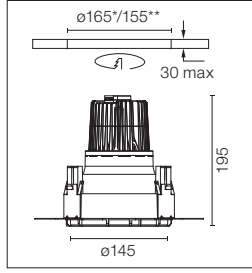

* No Trim | ** Trim

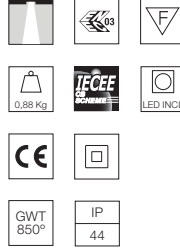

LED Einbauleuchte. Elektronischer Ferntransformator 220/240V inbegriffen.
Vorinstallationsrahmen. Muss separat bestellt werden.

Recessed luminaire with LED light source. Remote electronic transformer 220/240V included.
Pre-installation frame. To be ordered separately.

- 2700K**
Non Dimmable
- 03.4585.B1
 - Dali Version
 - 03.4585.B1.DA
 - 1-10V
 - 03.4585.B1.1V

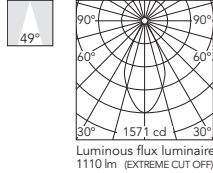

Beam Angle: 49°

h(m)	E(lx)	D(m)
1	1571	0.91
2	393	1.82
3	175	2.73
4	98	3.64
5	63	4.55

- 3000K**
Non Dimmable
- 03.4584.B1
 - Dali Version
 - 03.4584.B1.DA
 - 1-10V
 - 03.4584.B1.1V

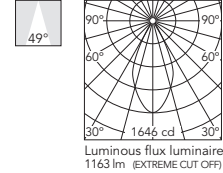

Beam Angle: 49°

h(m)	E(lx)	D(m)
1	1646	0.91
2	411	1.82
3	183	2.73
4	103	3.64
5	66	4.55

- Non Dimmable
- 03.4585.GL
 - Dali Version
 - 03.4585.GL.DA
 - 1-10V
 - 03.4585.GL.1V

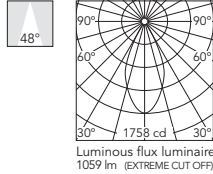

Beam Angle: 48°

h(m)	E(lx)	D(m)
1	1758	0.88
2	439	1.77
3	195	2.65
4	110	3.54
5	70	4.42

- Non Dimmable
- 03.4584.GL
 - Dali Version
 - 03.4584.GL.DA
 - 1-10V
 - 03.4584.GL.1V

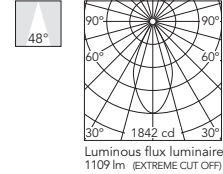

Beam Angle: 48°

h(m)	E(lx)	D(m)
1	1842	0.88
2	460	1.77
3	205	2.65
4	115	3.54
5	74	4.42

- Non Dimmable
- 03.4585.BU
 - Dali Version
 - 03.4585.BU.DA
 - 1-10V
 - 03.4585.BU.1V

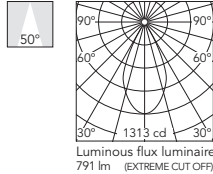

Beam Angle: 50°

h(m)	E(lx)	D(m)
1	1313	0.93
2	328	1.86
3	146	2.79
4	82	3.72
5	53	4.65

- Non Dimmable
- 03.4584.BU
 - Dali Version
 - 03.4584.BU.DA
 - 1-10V
 - 03.4584.BU.1V

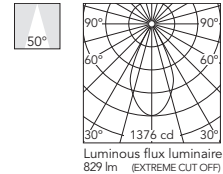

Beam Angle: 50°

h(m)	E(lx)	D(m)
1	1376	0.93
2	344	1.86
3	153	2.79
4	86	3.72
5	55	4.65

- Non Dimmable
- 03.4585.74
 - Dali Version
 - 03.4585.74.DA
 - 1-10V
 - 03.4585.74.1V

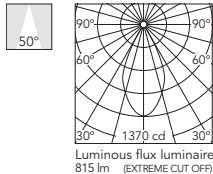

Beam Angle: 50°

h(m)	E(lx)	D(m)
1	1370	0.93
2	343	1.86
3	152	2.79
4	86	3.72
5	55	4.65

- Non Dimmable
- 03.4584.74
 - Dali Version
 - 03.4584.74.DA
 - 1-10V
 - 03.4584.74.1V

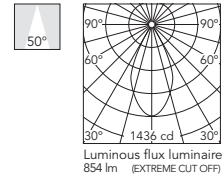

Beam Angle: 50°

h(m)	E(lx)	D(m)
1	1436	0.93
2	359	1.86
3	160	2.79
4	90	3.72
5	57	4.65

- Non Dimmable
- 03.4585.CU
 - Dali Version
 - 03.4585.CU.DA
 - 1-10V
 - 03.4585.CU.1V

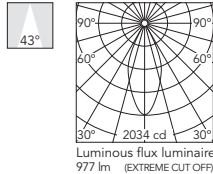

Beam Angle: 43°

h(m)	E(lx)	D(m)
1	2034	0.78
2	509	1.57
3	226	2.35
4	127	3.14
5	81	3.92

- Non Dimmable
- 03.4584.CU
 - Dali Version
 - 03.4584.CU.DA
 - 1-10V
 - 03.4584.CU.1V

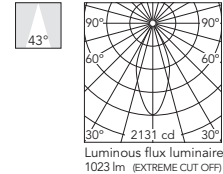

Beam Angle: 43°

h(m)	E(lx)	D(m)
1	2131	0.78
2	533	1.57
3	237	2.35
4	133	3.14
5	85	3.92

KAP

Kap Ø145 Deep

Light Source: Phosphor LED 17W - 1400 lm - 2700K/CRI 98 / 17W - 1400 lm - 3000K/CRI 98

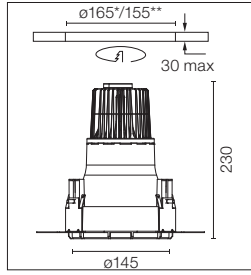

* No Trim | ** Trim

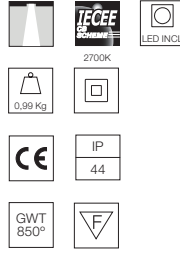

LED Einbauleuchte. Elektronischer Ferntransformator 220/240V inbegriffen. Vorinstallationsrahmen. Muss separat bestellt werden.

Recessed luminaire with LED light source. Remote electronic transformer 220/240V included. Pre-installation frame. To be ordered separately.

2700K

Non Dimmable

- 03.4497.B1B
- Dali Version
- 03.4497.B1BDA
- 1-10V
- 03.4497.B1B1V

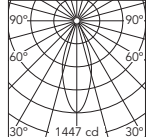

Beam Angle: 37°	h(m)	E(lx)	D(m)
1	1447	0.67	
2	362	1.34	
3	161	2.01	
4	90	2.69	
5	58	3.36	

Luminous flux luminaire 694 lm (EXTREME CUT OFF)

3000K

Non Dimmable

- 03.4482.B1C
- Dali Version
- 03.4482.B1CDA
- 1-10V
- 03.4482.B1C1V

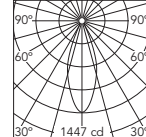

Beam Angle: 37°	h(m)	E(lx)	D(m)
1	1447	0.67	
2	362	1.34	
3	161	2.01	
4	90	2.69	
5	58	3.36	

Luminous flux luminaire 694 lm (EXTREME CUT OFF)

Non Dimmable

- 03.4497.GLB
- Dali Version
- 03.4497.GLBDA
- 1-10V
- 03.4497.GLB1V

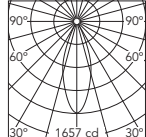

Beam Angle: 36°	h(m)	E(lx)	D(m)
1	1657	0.65	
2	414	1.30	
3	184	1.96	
4	104	2.61	
5	66	3.26	

Luminous flux luminaire 678 lm (EXTREME CUT OFF)

Non Dimmable

- 03.4482.GLC
- Dali Version
- 03.4482.GLCDA
- 1-10V
- 03.4482.GLC1V

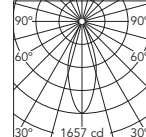

Beam Angle: 36°	h(m)	E(lx)	D(m)
1	1657	0.65	
2	414	1.30	
3	184	1.96	
4	104	2.61	
5	66	3.26	

Luminous flux luminaire 678 lm (EXTREME CUT OFF)

Non Dimmable

- 03.4497.BUB
- Dali Version
- 03.4497.BUBDA
- 1-10V
- 03.4497.BUB1V

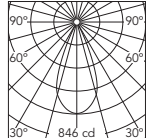

Beam Angle: 44°	h(m)	E(lx)	D(m)
1	846	0.80	
2	211	1.60	
3	94	2.39	
4	53	3.19	
5	34	3.99	

Luminous flux luminaire 406 lm (EXTREME CUT OFF)

Non Dimmable

- 03.4482.BUC
- Dali Version
- 03.4482.BUCDA
- 1-10V
- 03.4482.BUC1V

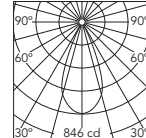

Beam Angle: 44°	h(m)	E(lx)	D(m)
1	846	0.80	
2	211	1.60	
3	94	2.39	
4	53	3.19	
5	34	3.99	

Luminous flux luminaire 406 lm (EXTREME CUT OFF)

Non Dimmable

- 03.4497.74B
- Dali Version
- 03.4497.74BDA
- 1-10V
- 03.4497.74B1V

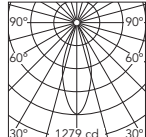

Beam Angle: 37°	h(m)	E(lx)	D(m)
1	1279	0.66	
2	320	1.32	
3	142	1.98	
4	80	2.64	
5	51	3.30	

Luminous flux luminaire 450 lm (EXTREME CUT OFF)

Non Dimmable

- 03.4482.74C
- Dali Version
- 03.4482.74CDA
- 1-10V
- 03.4482.74C1V

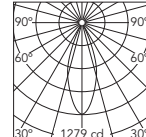

Beam Angle: 37°	h(m)	E(lx)	D(m)
1	1279	0.66	
2	320	1.32	
3	142	1.98	
4	80	2.64	
5	51	3.30	

Luminous flux luminaire 450 lm (EXTREME CUT OFF)

Non Dimmable

- 03.4497.CUB
- Dali Version
- 03.4497.CUBDA
- 1-10V
- 03.4497.CUB1V

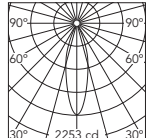

Beam Angle: 28°	h(m)	E(lx)	D(m)
1	2253	0.50	
2	563	1.01	
3	250	1.51	
4	141	2.02	
5	90	2.52	

Luminous flux luminaire 662 lm (EXTREME CUT OFF)

Non Dimmable

- 03.4482.CUC
- Dali Version
- 03.4482.CUCDA
- 1-10V
- 03.4482.CUC1V

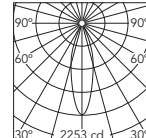

Beam Angle: 28°	h(m)	E(lx)	D(m)
1	2253	0.50	
2	563	1.01	
3	250	1.51	
4	141	2.02	
5	90	2.52	

Luminous flux luminaire 662 lm (EXTREME CUT OFF)

KAP

Kap Ø145 Deep

Light Source: LED Array 17W - 1800 lm - 2700K/CRI 90 / 17W - 2000 lm - 3000K/CRI 90

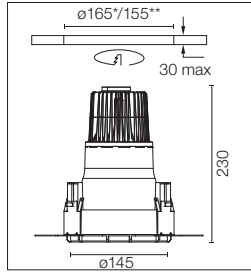

* No Trim | ** Trim

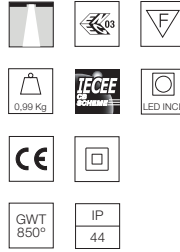

LED Einbauleuchte. Elektronischer Ferntransformator 220/240V inbegriffen.
Vorinstallationsrahmen. Muss separat bestellt werden.

Recessed luminaire with LED light source. Remote electronic transformer 220/240V included.
Pre-installation frame. To be ordered separately.

2700K

- Non Dimmable
- 03.4587.B1
- Dali Version
- 03.4587.B1.DA
- 1-10V
- 03.4587.B1.1V

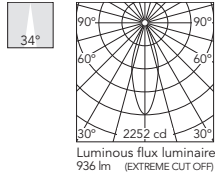

Beam Angle: 34°

h(m)	E(lx)	D(m)
1	2252	0.61
2	563	1.23
3	250	1.84
4	141	2.45
5	90	3.06

3000K

- Non Dimmable
- 03.4586.B1
- Dali Version
- 03.4586.B1.DA
- 1-10V
- 03.4586.B1.1V

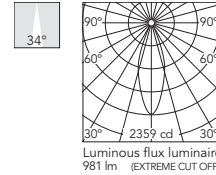

Beam Angle: 34°

h(m)	E(lx)	D(m)
1	2359	0.61
2	590	1.23
3	262	1.84
4	147	2.45
5	94	3.06

- Non Dimmable
- 03.4587.GL
- Dali Version
- 03.4587.GL.DA
- 1-10V
- 03.4587.GL.1V

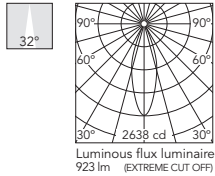

Beam Angle: 32°

h(m)	E(lx)	D(m)
1	2638	0.58
2	660	1.16
3	293	1.74
4	165	2.31
5	106	2.89

- Non Dimmable
- 03.4586.GL
- Dali Version
- 03.4586.GL.DA
- 1-10V
- 03.4586.GL.1V

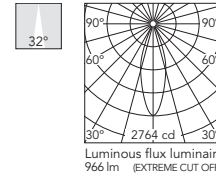

Beam Angle: 32°

h(m)	E(lx)	D(m)
1	2764	0.58
2	691	1.16
3	307	1.74
4	173	2.31
5	111	2.89

- Non Dimmable
- 03.4587.BU
- Dali Version
- 03.4587.BU.DA
- 1-10V
- 03.4587.BU.1V

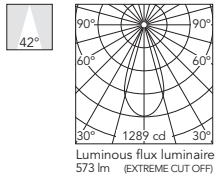

Beam Angle: 42°

h(m)	E(lx)	D(m)
1	1289	0.77
2	322	1.53
3	143	2.30
4	81	3.07
5	52	3.83

- Non Dimmable
- 03.4586.BU
- Dali Version
- 03.4586.BU.DA
- 1-10V
- 03.4586.BU.1V

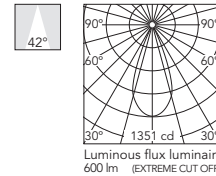

Beam Angle: 42°

h(m)	E(lx)	D(m)
1	1351	0.77
2	338	1.53
3	150	2.30
4	84	3.07
5	54	3.83

- Non Dimmable
- 03.4587.74
- Dali Version
- 03.4587.74.DA
- 1-10V
- 03.4587.74.1V

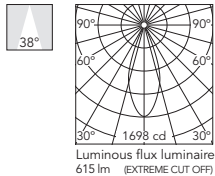

Beam Angle: 38°

h(m)	E(lx)	D(m)
1	1698	0.69
2	424	1.38
3	189	2.07
4	106	2.76
5	68	3.45

- Non Dimmable
- 03.4586.74
- Dali Version
- 03.4586.74.DA
- 1-10V
- 03.4586.74.1V

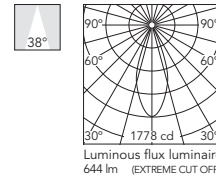

Beam Angle: 38°

h(m)	E(lx)	D(m)
1	1778	0.69
2	445	1.38
3	198	2.07
4	111	2.76
5	71	3.45

- Non Dimmable
- 03.4587.CU
- Dali Version
- 03.4587.CU.DA
- 1-10V
- 03.4587.CU.1V

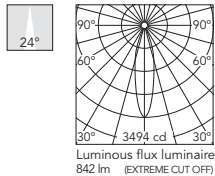

Beam Angle: 24°

h(m)	E(lx)	D(m)
1	3494	0.43
2	873	0.86
3	388	1.29
4	218	1.72
5	140	2.15

- Non Dimmable
- 03.4586.CU
- Dali Version
- 03.4586.CU.DA
- 1-10V
- 03.4586.CU.1V

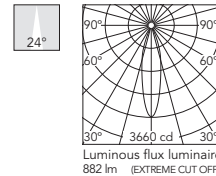

Beam Angle: 24°

h(m)	E(lx)	D(m)
1	3660	0.43
2	915	0.86
3	407	1.29
4	229	1.72
5	146	2.15

KAP

Kap Ø145 Wall-Washer

Light Source: Phosphor LED 17W - 1400 lm - 2700K/CRI 98 / 17W - 1400 lm - 3000K/CRI 98

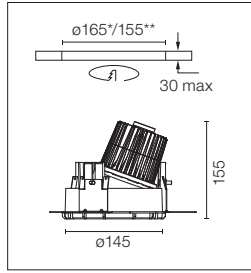

* No Trim | ** Trim

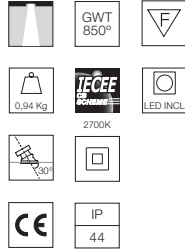

LED Einbauleuchte. Elektronischer Ferntransformator 220/240V inbegriffen.
Vorinstallationsrahmen. Muss separat bestellt werden.

Recessed luminaire with LED light source. Remote electronic transformer 220/240V included.
Pre-installation frame. To be ordered separately.

- 2700K**
Non Dimmable
- 03.4498.B1B
 - Dali Version
 - 03.4498.B1BDA
 - 1-10V
 - 03.4498.B1B1V

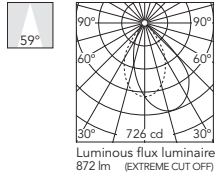

Beam Angle: 59°

h(m)	E(lx)	D(m)
1	726	1.26
2	181	2.53
3	81	3.79
4	45	5.05
5	29	6.32

- 3000K**
Non Dimmable
- 03.4475.B1C
 - Dali Version
 - 03.4475.B1CDA
 - 1-10V
 - 03.4475.B1C1V

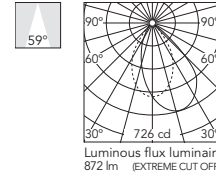

Beam Angle: 59°

h(m)	E(lx)	D(m)
1	726	1.26
2	181	2.53
3	81	3.79
4	45	5.05
5	29	6.32

- Non Dimmable
- 03.4498.GLB
 - Dali Version
 - 03.4498.GLBDA
 - 1-10V
 - 03.4498.GLB1V

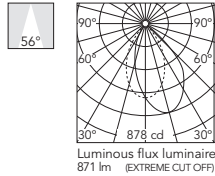

Beam Angle: 56°

h(m)	E(lx)	D(m)
1	878	1.18
2	219	2.37
3	98	3.55
4	55	4.73
5	35	5.92

- Non Dimmable
- 03.4475.GLC
 - Dali Version
 - 03.4475.GLCDA
 - 1-10V
 - 03.4475.GLC1V

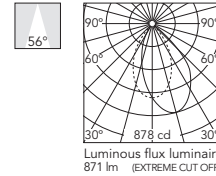

Beam Angle: 56°

h(m)	E(lx)	D(m)
1	878	1.18
2	219	2.37
3	98	3.55
4	55	4.73
5	35	5.92

- Non Dimmable
- 03.4498.BUB
 - Dali Version
 - 03.4498.BUBDA
 - 1-10V
 - 03.4498.BUB1V

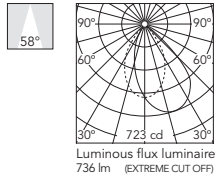

Beam Angle: 58°

h(m)	E(lx)	D(m)
1	723	1.25
2	181	2.51
3	80	3.76
4	45	5.01
5	29	6.26

- Non Dimmable
- 03.4475.BUC
 - Dali Version
 - 03.4475.BUCDA
 - 1-10V
 - 03.4475.BUC1V

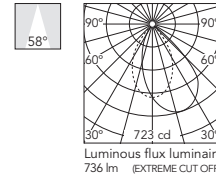

Beam Angle: 58°

h(m)	E(lx)	D(m)
1	723	1.25
2	181	2.51
3	80	3.76
4	45	5.01
5	29	6.26

- Non Dimmable
- 03.4498.74B
 - Dali Version
 - 03.4498.74BDA
 - 1-10V
 - 03.4498.74B1V

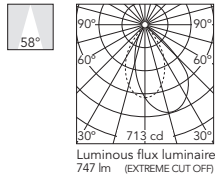

Beam Angle: 58°

h(m)	E(lx)	D(m)
1	713	1.24
2	178	2.48
3	79	3.72
4	45	4.96
5	29	6.20

- Non Dimmable
- 03.4475.74C
 - Dali Version
 - 03.4475.74CDA
 - 1-10V
 - 03.4475.74C1V

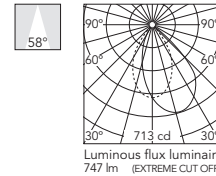

Beam Angle: 58°

h(m)	E(lx)	D(m)
1	713	1.24
2	178	2.48
3	79	3.72
4	45	4.96
5	29	6.20

- Non Dimmable
- 03.4498.CUB
 - Dali Version
 - 03.4498.CUBDA
 - 1-10V
 - 03.4498.CUB1V

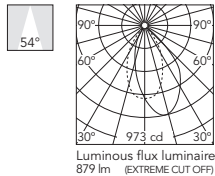

Beam Angle: 54°

h(m)	E(lx)	D(m)
1	973	1.10
2	243	2.21
3	108	3.31
4	61	4.42
5	39	5.52

- Non Dimmable
- 03.4475.CUC
 - Dali Version
 - 03.4475.CUCDA
 - 1-10V
 - 03.4475.CUC1V

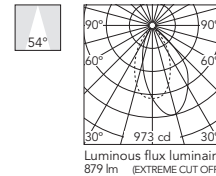

Beam Angle: 54°

h(m)	E(lx)	D(m)
1	973	1.10
2	243	2.21
3	108	3.31
4	61	4.42
5	39	5.52

KAP

Kap Ø145 Wall-Washer

Light Source: LED Array 17W - 1800 lm - 2700K/CRI 90 / 17W - 2000 lm - 3000K/CRI 90

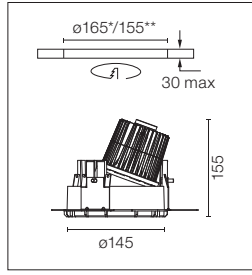

* No Trim | ** Trim



LED Einbauleuchte. Elektronischer Ferntransformator 220/240V inbegriffen.
Vorinstallationsrahmen. Muss separat bestellt werden.

Recessed luminaire with LED light source. Remote electronic transformer 220/240V included.
Pre-installation frame. To be ordered separately.

2700K

Non Dimmable

- 03.4589.B1
- Dali Version
- 03.4589.B1.DA
- 1-10V
- 03.4589.B1.1V

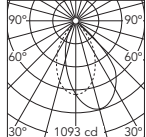

Beam Angle: 56°

h(m)	E(lx)	D(m)
1	1093	1.17
2	273	2.34
3	121	3.52
4	68	4.69
5	44	5.86

Luminous flux luminaire
1189 lm (EXTREME CUT OFF)

3000K

Non Dimmable

- 03.4588.B1
- Dali Version
- 03.4588.B1.DA
- 1-10V
- 03.4588.B1.1V

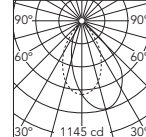

Beam Angle: 56°

h(m)	E(lx)	D(m)
1	1145	1.17
2	286	2.34
3	127	3.52
4	72	4.69
5	46	5.86

Luminous flux luminaire
1246 lm (EXTREME CUT OFF)

Non Dimmable

- 03.4589.GL
- Dali Version
- 03.4589.GL.DA
- 1-10V
- 03.4589.GL.1V

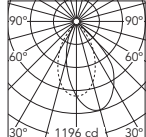

Beam Angle: 55°

h(m)	E(lx)	D(m)
1	1196	1.13
2	299	2.26
3	133	3.39
4	75	4.52
5	48	5.65

Luminous flux luminaire
1131 lm (EXTREME CUT OFF)

Non Dimmable

- 03.4588.GL
- Dali Version
- 03.4588.GL.DA
- 1-10V
- 03.4588.GL.1V

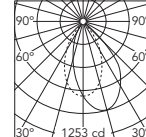

Beam Angle: 55°

h(m)	E(lx)	D(m)
1	1253	1.13
2	313	2.26
3	139	3.39
4	78	4.52
5	50	5.65

Luminous flux luminaire
1185 lm (EXTREME CUT OFF)

Non Dimmable

- 03.4589.BU
- Dali Version
- 03.4589.BU.DA
- 1-10V
- 03.4589.BU.1V

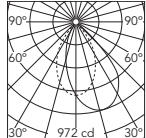

Beam Angle: 56°

h(m)	E(lx)	D(m)
1	972	1.17
2	243	2.34
3	108	3.51
4	61	4.68
5	39	5.85

Luminous flux luminaire
980 lm (EXTREME CUT OFF)

Non Dimmable

- 03.4588.BU
- Dali Version
- 03.4588.BU.DA
- 1-10V
- 03.4588.BU.1V

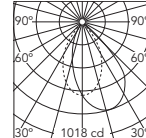

Beam Angle: 56°

h(m)	E(lx)	D(m)
1	1018	1.17
2	254	2.34
3	113	3.51
4	64	4.68
5	41	5.85

Luminous flux luminaire
1026 lm (EXTREME CUT OFF)

Non Dimmable

- 03.4589.74
- Dali Version
- 03.4589.74.DA
- 1-10V
- 03.4589.74.1V

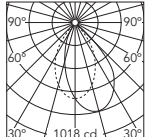

Beam Angle: 55°

h(m)	E(lx)	D(m)
1	1018	1.14
2	254	2.29
3	113	3.43
4	64	4.57
5	41	5.72

Luminous flux luminaire
999 lm (EXTREME CUT OFF)

Non Dimmable

- 03.4588.74
- Dali Version
- 03.4588.74.DA
- 1-10V
- 03.4588.74.1V

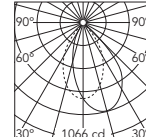

Beam Angle: 55°

h(m)	E(lx)	D(m)
1	1066	1.14
2	267	2.29
3	118	3.43
4	67	4.57
5	43	5.72

Luminous flux luminaire
1047 lm (EXTREME CUT OFF)

Non Dimmable

- 03.4589.CU
- Dali Version
- 03.4589.CU.DA
- 1-10V
- 03.4589.CU.1V

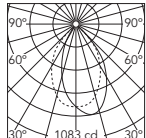

Beam Angle: 56°

h(m)	E(lx)	D(m)
1	1083	1.09
2	271	2.18
3	120	3.27
4	68	4.36
5	43	5.45

Luminous flux luminaire
1117 lm (EXTREME CUT OFF)

Non Dimmable

- 03.4588.CU
- Dali Version
- 03.4588.CU.DA
- 1-10V
- 03.4588.CU.1V

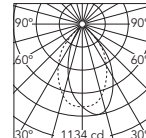

Beam Angle: 56°

h(m)	E(lx)	D(m)
1	1134	1.09
2	284	2.18
3	126	3.27
4	71	4.36
5	45	5.45

Luminous flux luminaire
1170 lm (EXTREME CUT OFF)

KAP

Easy Kap Ø50 Fixed - Optic Spot

Light Source: LED Array DC 200 mA - 7,5W - 595 lm - 2700K/CRI 90 / 7,5W - 635 lm - 3000K/CRI 90

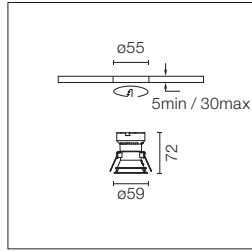

LED Einbauleuchte. Ohne Netzgerät. Installationsrahmen nicht notwendig. Recessed luminaire with LED light source. Power supply not included. Installation frame not necessary.

Empfohlene Netzgeräte / Recommended power supply*:

- Non Dimmable 60.9160
- Dimmable 0-10V 60.9483
- Dimmable Dali 60.9604
- Mains Dimming 60.9421
- Casambi 60.9392 + DALI/1-10V Driver

* Siehe Treiberkapitel / Refer to the Drivers chapter

2700K
□ 05.7200.B1

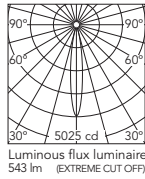

Beam Angle: 15°

h(m)	E(lx)	D(m)
1	5025	0.27
2	1256	0.53
3	558	0.80
4	314	1.07
5	201	1.33

Luminous flux luminaire 543 lm (EXTREME CUT OFF)

3000K
□ 05.7205.B1

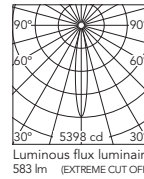

Beam Angle: 15°

h(m)	E(lx)	D(m)
1	5398	0.27
2	1349	0.53
3	600	0.80
4	337	1.07
5	216	1.33

Luminous flux luminaire 583 lm (EXTREME CUT OFF)

■ 05.7200.GL

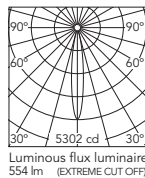

Beam Angle: 15°

h(m)	E(lx)	D(m)
1	5302	0.26
2	1325	0.53
3	589	0.79
4	331	1.06
5	212	1.32

Luminous flux luminaire 554 lm (EXTREME CUT OFF)

■ 05.7205.GL

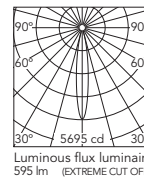

Beam Angle: 15°

h(m)	E(lx)	D(m)
1	5695	0.26
2	1424	0.53
3	633	0.79
4	356	1.06
5	228	1.32

Luminous flux luminaire 595 lm (EXTREME CUT OFF)

■ 05.7200.BU

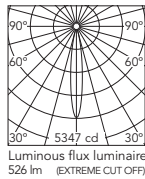

Beam Angle: 15°

h(m)	E(lx)	D(m)
1	5347	0.26
2	1337	0.52
3	594	0.78
4	334	1.04
5	214	1.30

Luminous flux luminaire 526 lm (EXTREME CUT OFF)

■ 05.7205.BU

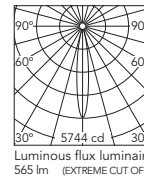

Beam Angle: 15°

h(m)	E(lx)	D(m)
1	5744	0.26
2	1436	0.52
3	638	0.78
4	359	1.04
5	230	1.30

Luminous flux luminaire 565 lm (EXTREME CUT OFF)

■ 05.7200.74

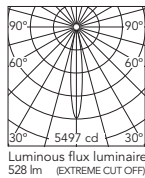

Beam Angle: 15°

h(m)	E(lx)	D(m)
1	5497	0.26
2	1374	0.52
3	611	0.77
4	344	1.03
5	220	1.29

Luminous flux luminaire 528 lm (EXTREME CUT OFF)

■ 05.7205.74

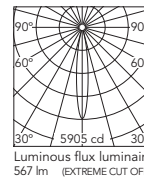

Beam Angle: 15°

h(m)	E(lx)	D(m)
1	5905	0.26
2	1476	0.52
3	656	0.77
4	369	1.03
5	236	1.29

Luminous flux luminaire 567 lm (EXTREME CUT OFF)

■ 05.7200.CU

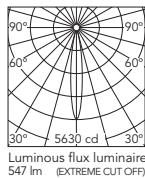

Beam Angle: 15°

h(m)	E(lx)	D(m)
1	5630	0.26
2	1408	0.51
3	626	0.77
4	352	1.03
5	225	1.29

Luminous flux luminaire 547 lm (EXTREME CUT OFF)

■ 05.7205.CU

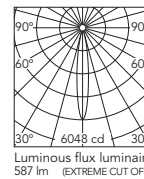

Beam Angle: 15°

h(m)	E(lx)	D(m)
1	6048	0.26
2	1512	0.51
3	672	0.77
4	378	1.03
5	242	1.29

Luminous flux luminaire 587 lm (EXTREME CUT OFF)

KAP

Easy Kap Ø50 Fixed - Optic Medium

Light Source: LED Array DC 200 mA - 7,5W - 595 lm - 2700K/CRI 90 / 7,5W - 635 lm - 3000K/CRI 90

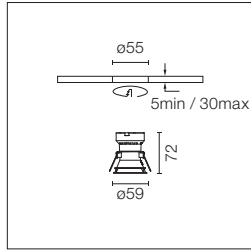

LED Einbauleuchte. Ohne Netzgerät. Installationsrahmen nicht notwendig. Recessed luminaire with LED light source. Power supply not included. Installation frame not necessary.

Empfohlene Netzgeräte / Recommended power supply*:

- Non Dimmable 60.9160
- Dimmable 0-10V 60.9483
- Dimmable Dali 60.9604
- Mains Dimming 60.9421
- Casambi 60.9392 + DALI/1-10V Driver

* Siehe Treiberkapitel / Refer to the Drivers chapter

2700K
□ 05.7201.B1

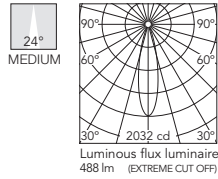

Beam Angle: 24°

h(m)	E(lx)	D(m)
1	2032	0.43
2	508	0.86
3	226	1.30
4	127	1.73
5	81	2.16

Luminous flux luminaire 488 lm (EXTREME CUT OFF)

3000K
□ 05.7206.B1

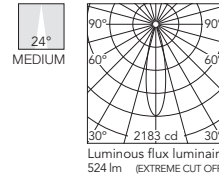

Beam Angle: 24°

h(m)	E(lx)	D(m)
1	2183	0.43
2	546	0.86
3	243	1.30
4	136	1.73
5	87	2.16

Luminous flux luminaire 524 lm (EXTREME CUT OFF)

■ 05.7201.GL

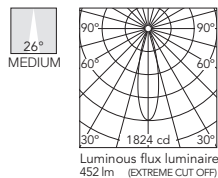

Beam Angle: 26°

h(m)	E(lx)	D(m)
1	1824	0.45
2	456	0.91
3	203	1.36
4	114	1.82
5	73	2.27

Luminous flux luminaire 452 lm (EXTREME CUT OFF)

■ 05.7206.GL

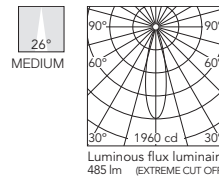

Beam Angle: 26°

h(m)	E(lx)	D(m)
1	1960	0.45
2	490	0.91
3	218	1.36
4	122	1.82
5	78	2.27

Luminous flux luminaire 485 lm (EXTREME CUT OFF)

■ 05.7201.BU

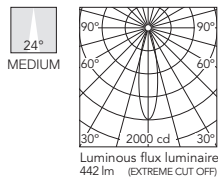

Beam Angle: 24°

h(m)	E(lx)	D(m)
1	2000	0.42
2	500	0.84
3	222	1.26
4	125	1.67
5	80	2.09

Luminous flux luminaire 442 lm (EXTREME CUT OFF)

■ 05.7206.BU

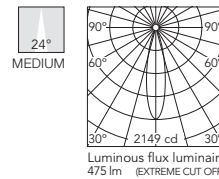

Beam Angle: 24°

h(m)	E(lx)	D(m)
1	2149	0.42
2	537	0.84
3	239	1.26
4	134	1.67
5	86	2.09

Luminous flux luminaire 475 lm (EXTREME CUT OFF)

■ 05.7201.74

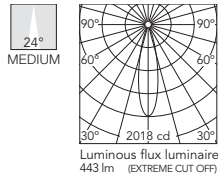

Beam Angle: 24°

h(m)	E(lx)	D(m)
1	2018	0.43
2	504	0.85
3	224	1.28
4	126	1.71
5	81	2.13

Luminous flux luminaire 443 lm (EXTREME CUT OFF)

■ 05.7206.74

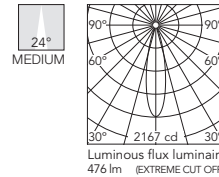

Beam Angle: 24°

h(m)	E(lx)	D(m)
1	2167	0.43
2	542	0.85
3	241	1.28
4	135	1.71
5	87	2.13

Luminous flux luminaire 476 lm (EXTREME CUT OFF)

■ 05.7201.CU

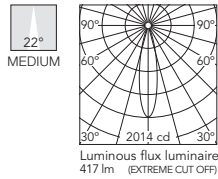

Beam Angle: 22°

h(m)	E(lx)	D(m)
1	2014	0.40
2	503	0.79
3	224	1.19
4	126	1.59
5	81	1.99

Luminous flux luminaire 417 lm (EXTREME CUT OFF)

■ 05.7206.CU

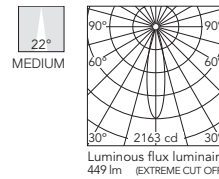

Beam Angle: 22°

h(m)	E(lx)	D(m)
1	2163	0.40
2	541	0.79
3	240	1.19
4	135	1.59
5	87	1.99

Luminous flux luminaire 449 lm (EXTREME CUT OFF)

KAP

Easy Kap Ø50 Fixed - Optic Flood

Light Source: LED Array DC 200 mA - 7,5W - 595 lm - 2700K/CRI 90 / 7,5W - 635 lm - 3000K/CRI 90

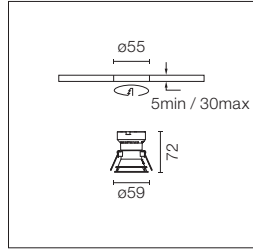

LED Einbauleuchte. Ohne Netzgerät. Installationsrahmen nicht notwendig. Recessed luminaire with LED light source. Power supply not included. Installation frame not necessary.

Empfohlene Netzgeräte / Recommended power supply*:

- Non Dimmable 60.9160
- Dimmable 0-10V 60.9483
- Dimmable Dali 60.9604
- Mains Dimming 60.9421
- Casambi 60.9392 + DALI/1-10V Driver

* Siehe Treiberkapitel / Refer to the Drivers chapter

2700K
□ 05.7202.B1

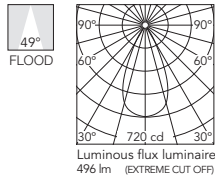

Beam Angle: 49°

h(m)	E(lx)	D(m)
1	720	0.91
2	180	1.83
3	80	2.74
4	45	3.66
5	29	4.57

3000K
□ 05.7207.B1

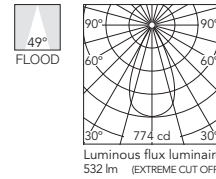

Beam Angle: 49°

h(m)	E(lx)	D(m)
1	774	0.91
2	193	1.83
3	86	2.74
4	48	3.66
5	31	4.57

■ 05.7202.GL

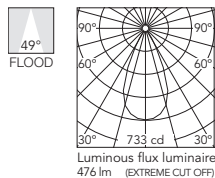

Beam Angle: 49°

h(m)	E(lx)	D(m)
1	733	0.90
2	183	1.81
3	81	2.71
4	46	3.61
5	29	4.52

■ 05.7207.GL

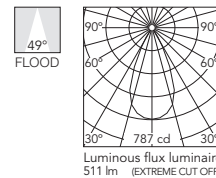

Beam Angle: 49°

h(m)	E(lx)	D(m)
1	787	0.90
2	197	1.81
3	87	2.71
4	49	3.61
5	31	4.52

■ 05.7202.BU

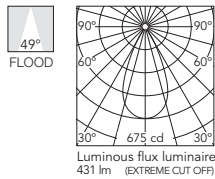

Beam Angle: 49°

h(m)	E(lx)	D(m)
1	675	0.91
2	169	1.81
3	75	2.72
4	42	3.63
5	27	4.53

■ 05.7207.BU

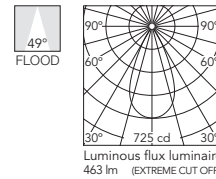

Beam Angle: 49°

h(m)	E(lx)	D(m)
1	725	0.91
2	181	1.81
3	81	2.72
4	45	3.63
5	29	4.53

■ 05.7202.74

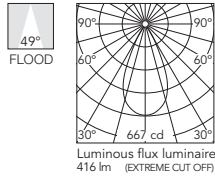

Beam Angle: 49°

h(m)	E(lx)	D(m)
1	667	0.91
2	167	1.82
3	74	2.72
4	42	3.63
5	27	4.54

■ 05.7207.74

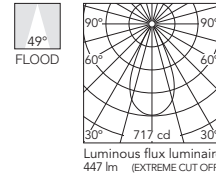

Beam Angle: 49°

h(m)	E(lx)	D(m)
1	717	0.91
2	179	1.82
3	80	2.72
4	45	3.63
5	29	4.54

■ 05.7202.CU

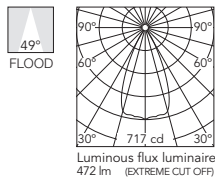

Beam Angle: 49°

h(m)	E(lx)	D(m)
1	717	0.91
2	179	1.83
3	80	2.74
4	45	3.66
5	29	4.57

■ 05.7207.CU

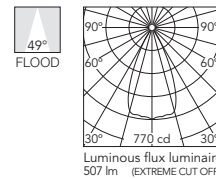

Beam Angle: 49°

h(m)	E(lx)	D(m)
1	770	0.91
2	193	1.83
3	86	2.74
4	48	3.66
5	31	4.57

KAP

Easy Kap Ø50 Adjustable - Optic Spot

Light Source: LED Array DC 200 mA - 7,5W - 595 lm - 2700K/CRI 90 / 7,5W - 635 lm - 3000K/CRI 90

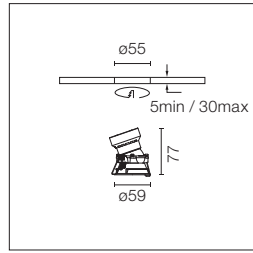

LED Einbauleuchte. Ohne Netzgerät. Installationsrahmen nicht notwendig. Recessed luminaire with LED light source. Power supply not included. Installation frame not necessary.

Empfohlene Netzgeräte / Recommended power supply*:

- Non Dimmable 60.9160
- Dimmable 0-10V 60.9483
- Dimmable Dali 60.9604
- Mains Dimming 60.9421
- Casambi 60.9392 + DALI/1-10V Driver

* Siehe Treiberkapitel / Refer to the Drivers chapter

2700K
□ 05.7210.B1

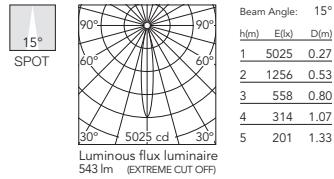

3000K
□ 05.7215.B1

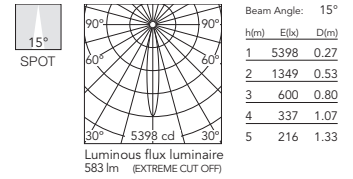

■ 05.7210.GL

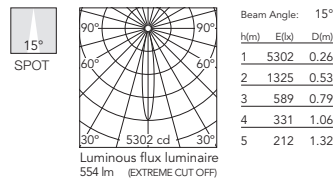

■ 05.7215.GL

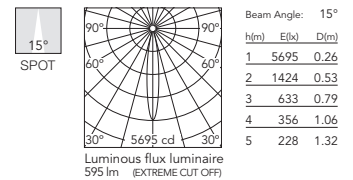

■ 05.7210.BU

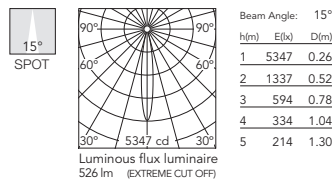

■ 05.7215.BU

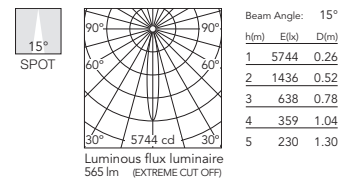

■ 05.7210.74

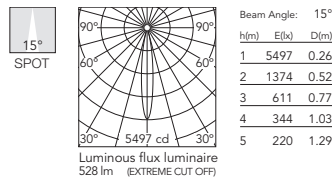

■ 05.7215.74

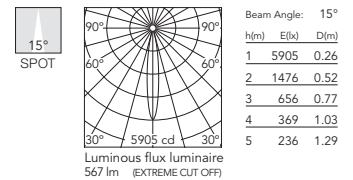

■ 05.7210.CU

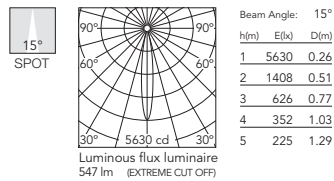

■ 05.7215.CU

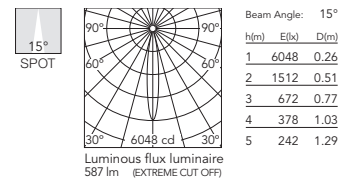

KAP

Easy Kap Ø50 Adjustable - Optic Medium

Light Source: LED Array DC 200 mA - 7,5W - 595 lm - 2700K/CRI 90 / 7,5W - 635 lm - 3000K/CRI 90

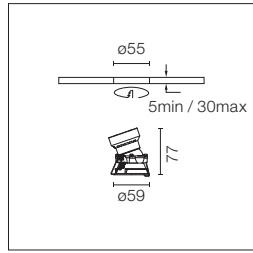

LED Einbauleuchte. Ohne Netzgerät. Installationsrahmen nicht notwendig. Recessed luminaire with LED light source. Power supply not included. Installation frame not necessary.

Empfohlene Netzgeräte / Recommended power supply*:

Non Dimmable	60.9160
Dimmable 0-10V	60.9483
Dimmable Dali	60.9604
Mains Dimming	60.9421
Casambi	60.9392 + DALI/1-10V Driver

* Siehe Treiberkapitel / Refer to the Drivers chapter

2700K
□ 05.7211.B1

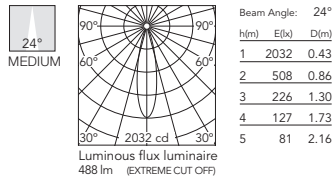

3000K
□ 05.7216.B1

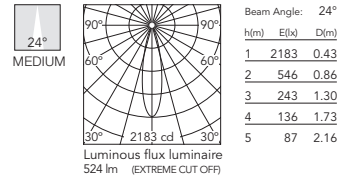

■ 05.7211.GL

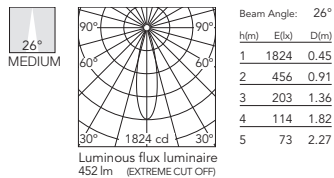

■ 05.7216.GL

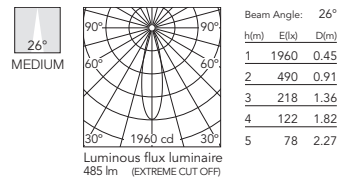

■ 05.7211.BU

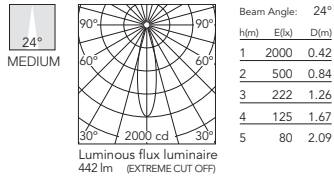

■ 05.7216.BU

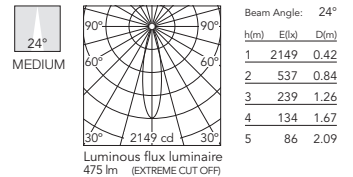

■ 05.7211.74

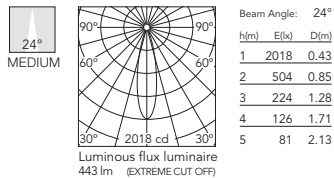

■ 05.7216.74

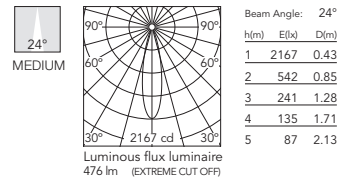

■ 05.7211.CU

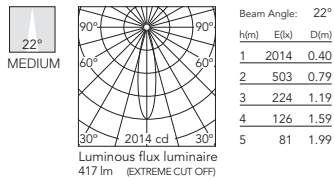

■ 05.7216.CU

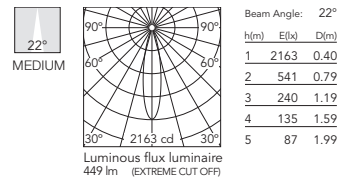

KAP

Easy Kap Ø50 Adjustable - Optic Flood

Light Source: LED Array DC 200 mA - 7,5W - 595 lm - 2700K/CRI 90 / 7,5W - 635 lm - 3000K/CRI 90

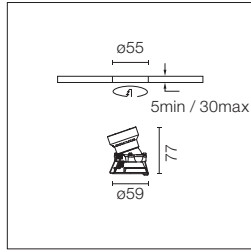

LED Einbauleuchte. Ohne Netzgerät. Installationsrahmen nicht notwendig. Recessed luminaire with LED light source. Power supply not included. Installation frame not necessary.

Empfohlene Netzgeräte / Recommended power supply*:

- Non Dimmable 60.9160
- Dimmable 0-10V 60.9483
- Dimmable Dali 60.9604
- Mains Dimming 60.9421
- Casambi 60.9392 + DALI/1-10V Driver

* Siehe Treiberkapitel / Refer to the Drivers chapter

2700K
□ 05.7212.B1

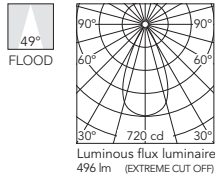

Beam Angle: 49°

h(m)	E(lx)	D(m)
1	720	0.91
2	180	1.83
3	80	2.74
4	45	3.66
5	29	4.57

3000K
□ 05.7217.B1

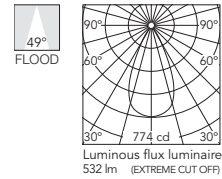

Beam Angle: 49°

h(m)	E(lx)	D(m)
1	774	0.91
2	193	1.83
3	86	2.74
4	48	3.66
5	31	4.57

■ 05.7212.GL

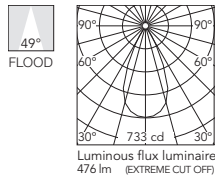

Beam Angle: 49°

h(m)	E(lx)	D(m)
1	733	0.90
2	183	1.81
3	81	2.71
4	46	3.61
5	29	4.52

■ 05.7217.GL

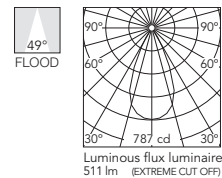

Beam Angle: 49°

h(m)	E(lx)	D(m)
1	787	0.90
2	197	1.81
3	87	2.71
4	49	3.61
5	31	4.52

■ 05.7212.BU

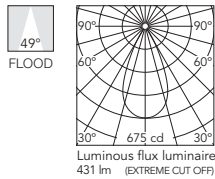

Beam Angle: 49°

h(m)	E(lx)	D(m)
1	675	0.91
2	169	1.81
3	75	2.72
4	42	3.63
5	27	4.53

■ 05.7217.BU

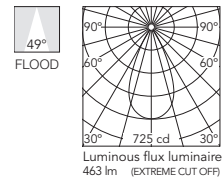

Beam Angle: 49°

h(m)	E(lx)	D(m)
1	725	0.91
2	181	1.81
3	81	2.72
4	45	3.63
5	29	4.53

■ 05.7212.74

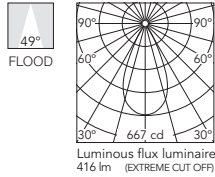

Beam Angle: 49°

h(m)	E(lx)	D(m)
1	667	0.91
2	167	1.82
3	74	2.72
4	42	3.63
5	27	4.54

■ 05.7217.74

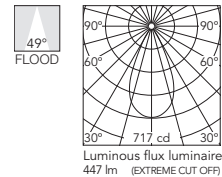

Beam Angle: 49°

h(m)	E(lx)	D(m)
1	717	0.91
2	179	1.82
3	80	2.72
4	45	3.63
5	29	4.54

■ 05.7212.CU

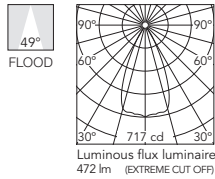

Beam Angle: 49°

h(m)	E(lx)	D(m)
1	717	0.91
2	179	1.83
3	80	2.74
4	45	3.66
5	29	4.57

■ 05.7217.CU

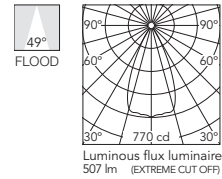

Beam Angle: 49°

h(m)	E(lx)	D(m)
1	770	0.91
2	193	1.83
3	86	2.74
4	48	3.66
5	31	4.57

KAP

Easy Kap Ø80/ Easy Kap Ø80 Plus - Fixed - Optic Spot

Light Source: Easy Kap Ø80: LED Array DC 500 mA - 9,2W - 935 lm - 2700K/CRI 90 / 9,2W - 974 lm - 3000K/CRI 90
Easy Kap Ø80 Plus: LED Array DC 700 mA - 13W - 1370 lm - 2700K/CRI 90 / 13W - 1460 lm - 3000K/CRI 90

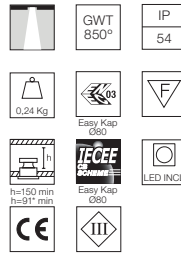
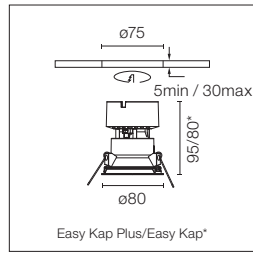

LED Einbauleuchte. Ohne Netzgerät. Installationsrahmen nicht notwendig. Diffusorlinse inbegriffen.
 Recessed luminaire with LED light source. Power supply not included. Installation frame not necessary. Diffusing lens included.

Empfohlene Netzgeräte / Recommended power supply*:

	Easy Kap Ø80	Easy Kap Ø80 Plus
Non Dimmable	60.9160	60.9592
Dimmable 0/1-10V	60.9188	60.9188
Dimmable Dali 1	60.8847	60.8847
Dimmable Dali 2	60.9222	60.9222
Mains Dimming	60.9411	60.9467
Casambi	60.9207	60.9207

* Siehe Treiberkapitel / Refer to the Drivers chapter

- 2700K**
 Easy Kap Ø80
 03.4288.B1
 Easy Kap Ø80 Plus
 05.7441.B1

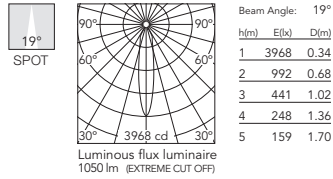

- 3000K**
 Easy Kap Ø80
 03.4287.B1
 Easy Kap Ø80 Plus
 05.7440.B1

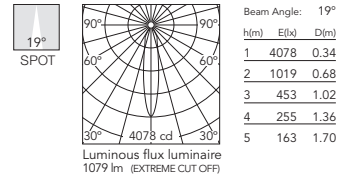

- Easy Kap Ø80
 03.4288.GL
 Easy Kap Ø80 Plus
 05.7441.GL

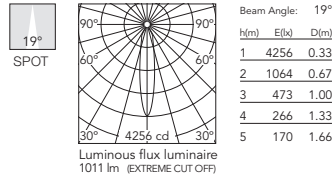

- Easy Kap Ø80
 03.4287.GL
 Easy Kap Ø80 Plus
 05.7440.GL

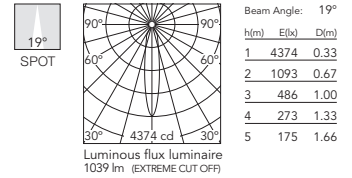

- Easy Kap Ø80
 03.4288.BU
 Easy Kap Ø80 Plus
 05.7441.BU

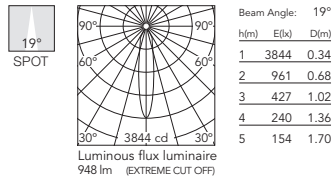

- Easy Kap Ø80
 03.4287.BU
 Easy Kap Ø80 Plus
 05.7440.BU

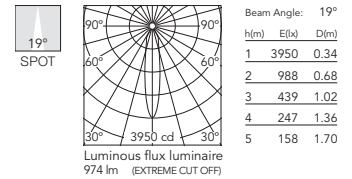

- Easy Kap Ø80
 03.4288.74
 Easy Kap Ø80 Plus
 05.7441.74

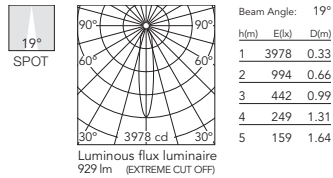

- Easy Kap Ø80
 03.4287.74
 Easy Kap Ø80 Plus
 05.7440.74

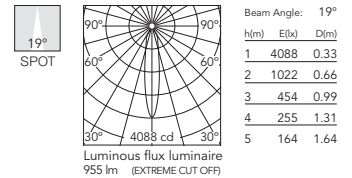

- Easy Kap Ø80
 03.4288.CU
 Easy Kap Ø80 Plus
 05.7441.CU

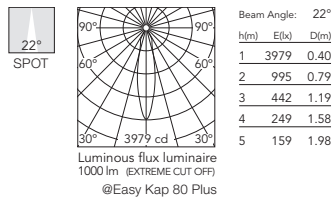

- Easy Kap Ø80
 03.4287.CU
 Easy Kap Ø80 Plus
 05.7440.CU

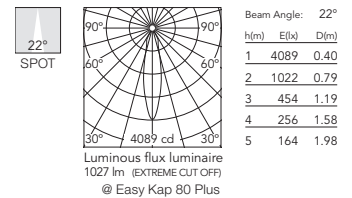

Easy Kap Ø80 Fixed - Optic Spot - Dim To Warm

Light Source: LED Array 13W - 1800K - 2850K/CRI 95 - Dim To Warm

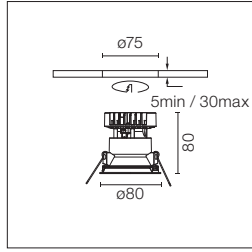

GWT 850°
 IP 54
 0,24 Kg
 03
 F
 h=91 mm
 LED INCL
 CE

LED Einbauleuchte. 220-240V und dimmbares 1-10V Netzteil inklusive. Für Versionen mit 110-V-Geräten wenden Sie sich an das Frontoffice. Installationsrahmen nicht notwendig. Diffusorlinse inbegriffen.

Recessed luminaire with LED light source. 220-240V & dimmable 1-10V power supply included. For 110V PSU versions, please consult with the front office. Installation frame not necessary. Diffusing lens included.

1800K-2850K
 03.4287.B1.LE

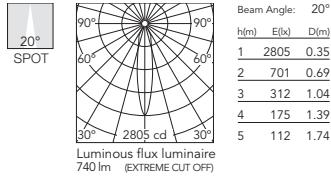

03.4287.GL.LE

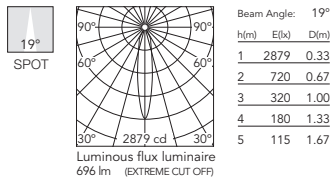

03.4287.BU.LE

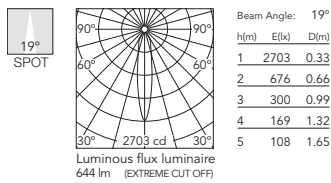

03.4287.74.LE

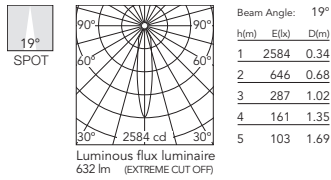

03.4287.CU.LE

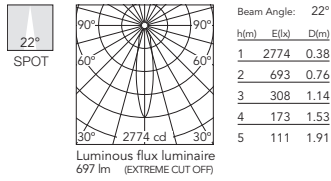

K AP

Easy Kap Ø80/Easy Kap Ø80 Plus - Fixed - Optic Medium

Light Source: Easy Kap Ø80: LED Array DC 500 mA - 9,2W - 935 lm - 2700K/CRI 90 / 9,2W - 974 lm - 3000K/CRI 90
Easy Kap Ø80 Plus: LED Array DC 700 mA - 13W - 1370 lm - 2700K/CRI 90 / 13W - 1460 lm - 3000K/CRI 90

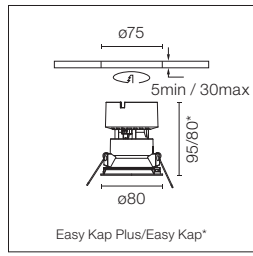

LED Einbauleuchte. Ohne Netzgerät. Installationsrahmen nicht notwendig. Diffusorlinse inbegriffen. Recessed luminaire with LED light source. Power supply not included. Installation frame not necessary. Diffusing lens included.

Empfohlene Netzgeräte / Recommended power supply*:

	Easy Kap Ø80	Easy Kap Ø80 Plus
Non Dimmable	60.9160	60.9592
Dimmable 0/1-10V	60.9188	60.9188
Dimmable DALI 1	60.8847	60.8847
Dimmable DALI 2	60.9222	60.9222
Mains Dimming	60.9411	60.9467
Casambi	60.9207	60.9207

* Siehe Treiberkapitel / Refer to the Drivers chapter

- 2700K**
 Easy Kap Ø80
 03.4193.B1
 Easy Kap Ø80 Plus
 05.7431.B1

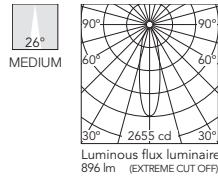

- 3000K**
 Easy Kap Ø80
 03.4192.B1
 Easy Kap Ø80 Plus
 05.7430.B1

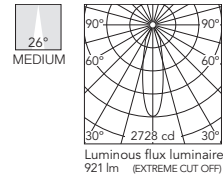

- Easy Kap Ø80
 03.4193.GL
 Easy Kap Ø80 Plus
 05.7431.GL

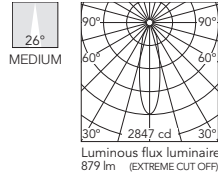

- Easy Kap Ø80
 03.4192.GL
 Easy Kap Ø80 Plus
 05.7430.GL

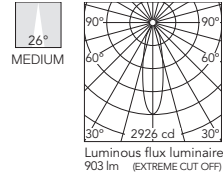

- Easy Kap Ø80
 03.4193.BU
 Easy Kap Ø80 Plus
 05.7431.BU

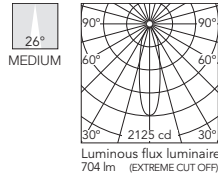

- Easy Kap Ø80
 03.4192.BU
 Easy Kap Ø80 Plus
 05.7430.BU

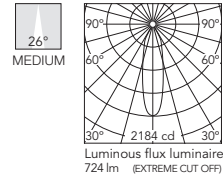

- Easy Kap Ø80
 03.4193.74
 Easy Kap Ø80 Plus
 05.7431.74

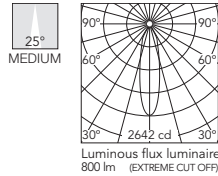

- Easy Kap Ø80
 03.4192.74
 Easy Kap Ø80 Plus
 05.7430.74

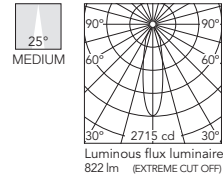

- Easy Kap Ø80
 03.4193.CU
 Easy Kap Ø80 Plus
 05.7431.CU

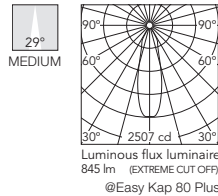

- Easy Kap Ø80
 03.4192.CU
 Easy Kap Ø80 Plus
 05.7430.CU

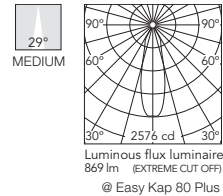

Easy Kap Ø80 Fixed - Optic Medium - Dim To Warm

Light Source: LED Array 13W - 1800K - 2850K/CRI 95 - Dim To Warm

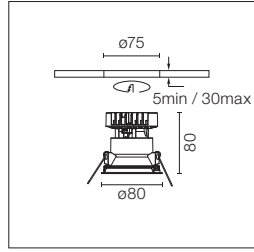

GWT 850°
 IP 54
 0,24 Kg
 03
 F
 h=91 mm
 LED INCL
 CE

LED Einbauleuchte. 220-240V und dimmbares 1-10V Netzteil inklusive. Für Versionen mit 110-V-Geräten wenden Sie sich an das Frontoffice. Installationsrahmen nicht notwendig. Diffusorlinse inbegriffen.

Recessed luminaire with LED light source. 220-240V & dimmable 1-10V power supply included. For 110V PSU versions, please consult with the front office. Installation frame not necessary. Diffusing lens included.

1800K-2850K
 03.4192.B1.LE

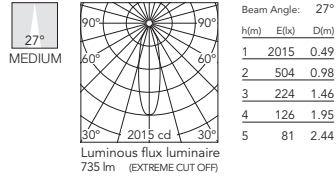

03.4192.GL.LE

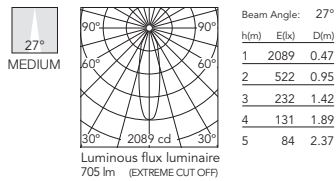

03.4192.BU.LE

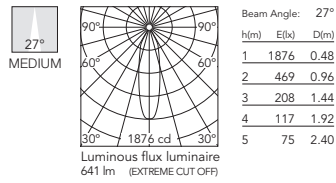

03.4192.74.LE

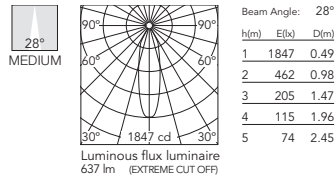

03.4192.CU.LE

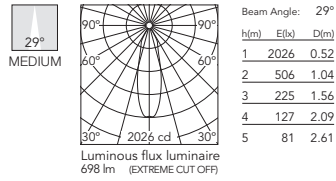

K AP

Easy Kap Ø80/Easy Kap Ø80 Plus - Fixed - Optic Flood

Light Source: Easy Kap Ø80: LED Array DC 500 mA - 9,2W - 935 lm - 2700K/CRI 90 / 9,2W - 974 lm - 3000K/CRI 90
Easy Kap Ø80 Plus: LED Array DC 700 mA - 13W - 1370 lm - 2700K/CRI 90 / 13W - 1460 lm - 3000K/CRI 90

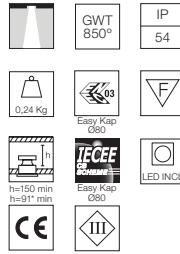
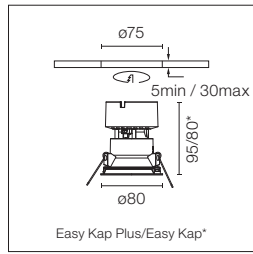

LED Einbauleuchte. Ohne Netzgerät. Installationsrahmen nicht notwendig. Diffusorlinse inbegriffen.
 Recessed luminaire with LED light source. Power supply not included. Installation frame not necessary. Diffusing lens included.

Empfohlene Netzgeräte / Recommended power supply*:

	Easy Kap Ø80	Easy Kap Ø80 Plus
Non Dimmable	60.9160	60.9592
Dimmable 0/1-10V	60.9188	60.9188
Dimmable Dali 1	60.8847	60.8847
Dimmable Dali 2	60.9222	60.9222
Mains Dimming	60.9411	60.9467
Casambi	60.9207	60.9207

* Siehe Treiberkapitel / Refer to the Drivers chapter

- 2700K**
 Easy Kap Ø80
 03.4298.B1
 Easy Kap Ø80 Plus
 05.7447.B1

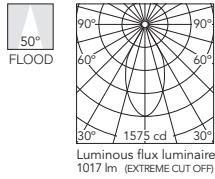

Beam Angle: 50°

h(m)	E(lx)	D(m)
1	1575	0.93
2	394	1.86
3	175	2.79
4	98	3.72
5	63	4.65

Luminous flux luminaire
1017 lm (EXTREME CUT OFF)

- 3000K**
 Easy Kap Ø80
 03.4297.B1
 Easy Kap Ø80 Plus
 05.7446.B1

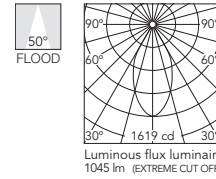

Beam Angle: 50°

h(m)	E(lx)	D(m)
1	1619	0.93
2	405	1.86
3	180	2.79
4	101	3.72
5	65	4.65

Luminous flux luminaire
1045 lm (EXTREME CUT OFF)

- Easy Kap Ø80
 03.4298.GL
 Easy Kap Ø80 Plus
 05.7447.GL

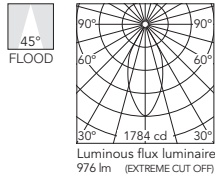

Beam Angle: 45°

h(m)	E(lx)	D(m)
1	1784	0.83
2	446	1.66
3	198	2.48
4	111	3.31
5	71	4.14

Luminous flux luminaire
976 lm (EXTREME CUT OFF)

- Easy Kap Ø80
 03.4297.GL
 Easy Kap Ø80 Plus
 05.7446.GL

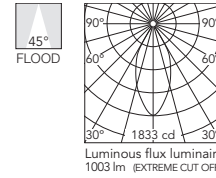

Beam Angle: 45°

h(m)	E(lx)	D(m)
1	1833	0.83
2	458	1.66
3	204	2.48
4	115	3.31
5	73	4.14

Luminous flux luminaire
1003 lm (EXTREME CUT OFF)

- Easy Kap Ø80
 03.4298.BU
 Easy Kap Ø80 Plus
 05.7447.BU

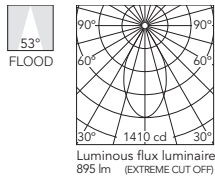

Beam Angle: 53°

h(m)	E(lx)	D(m)
1	1410	1.00
2	352	2.01
3	157	3.01
4	88	4.02
5	56	5.02

Luminous flux luminaire
895 lm (EXTREME CUT OFF)

- Easy Kap Ø80
 03.4297.BU
 Easy Kap Ø80 Plus
 05.7446.BU

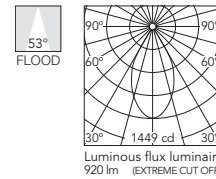

Beam Angle: 53°

h(m)	E(lx)	D(m)
1	1449	1.00
2	362	2.01
3	161	3.01
4	91	4.02
5	58	5.02

Luminous flux luminaire
920 lm (EXTREME CUT OFF)

- Easy Kap Ø80
 03.4298.74
 Easy Kap Ø80 Plus
 05.7447.74

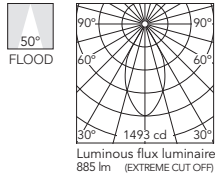

Beam Angle: 50°

h(m)	E(lx)	D(m)
1	1493	0.94
2	373	1.89
3	166	2.83
4	93	3.77
5	60	4.72

Luminous flux luminaire
885 lm (EXTREME CUT OFF)

- Easy Kap Ø80
 03.4297.74
 Easy Kap Ø80 Plus
 05.7446.74

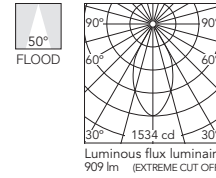

Beam Angle: 50°

h(m)	E(lx)	D(m)
1	1534	0.94
2	384	1.89
3	170	2.83
4	96	3.77
5	61	4.72

Luminous flux luminaire
909 lm (EXTREME CUT OFF)

- Easy Kap Ø80
 03.4298.CU
 Easy Kap Ø80 Plus
 05.7447.CU

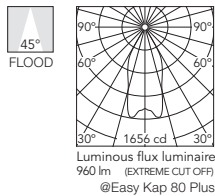

Beam Angle: 45°

h(m)	E(lx)	D(m)
1	1656	0.83
2	414	1.66
3	184	2.49
4	103	3.32
5	66	4.14

Luminous flux luminaire
960 lm (EXTREME CUT OFF)
 @Easy Kap 80 Plus

- Easy Kap Ø80
 03.4297.CU
 Easy Kap Ø80 Plus
 05.7446.CU

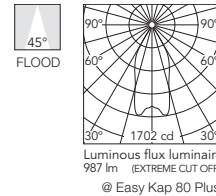

Beam Angle: 45°

h(m)	E(lx)	D(m)
1	1702	0.83
2	425	1.66
3	189	2.49
4	106	3.32
5	68	4.14

Luminous flux luminaire
987 lm (EXTREME CUT OFF)
 @ Easy Kap 80 Plus

Easy Kap Ø80 Fixed - Optic Flood - Dim To Warm

Light Source: LED Array 13W - 1800K - 2850K/CRI 95 - Dim To Warm

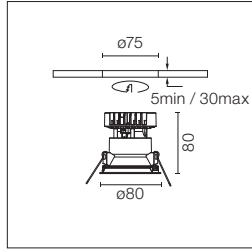

	GWT 850°		IP 54
	0.24 Kg		0.03
	h=91 min		LED INCL
	CE		TECEE

LED Einbauleuchte. 220-240V und dimmbares 1-10V Netzteil inklusive. Für Versionen mit 110-V-Geräten wenden Sie sich an das Frontoffice. Installationsrahmen nicht notwendig. Diffusorlinse inbegriffen.

Recessed luminaire with LED light source. 220-240V & dimmable 1-10V power supply included. For 110V PSU versions, please consult with the front office. Installation frame not necessary. Diffusing lens included.

1800K-2850K
 03.4297.B1.LE

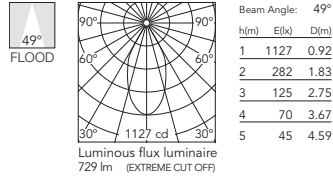

03.4297.GL.LE

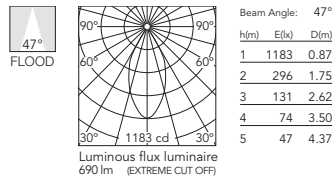

03.4297.BU.LE

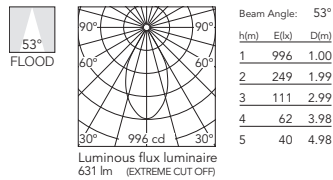

03.4297.74.LE

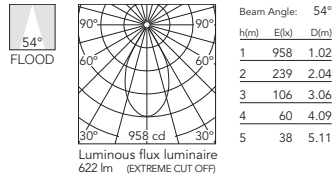

03.4297.CU.LE

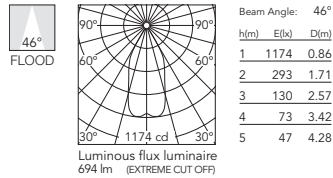

KAP

Easy Kap 80 Square/Easy Kap 80 Square Plus - Fixed - Optic Spot

Light Source: Easy Kap 80 Square: LED Array DC 500 mA - 9,2W - 935 lm - 2700K/CRI 90 / 9,2W - 974 lm - 3000K/CRI 90

Easy Kap 80 Square Plus: LED Array DC 700 mA - 13W - 1370 lm - 2700K/CRI 90 / 13W - 1460 lm - 3000K/CRI 90

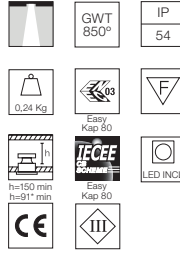
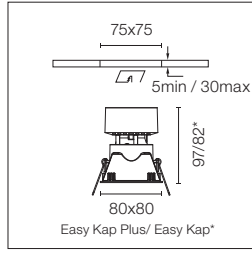

LED Einbauleuchte. Ohne Netzgerät. Installationsrahmen nicht notwendig. Diffusorlinse inbegriffen.

Recessed luminaire with LED light source. Power supply not included. Installation frame not necessary. Diffusing lens included.

Empfohlene Netzgeräte / Recommended power supply*:

	Easy Kap 80	Easy Kap 80 Plus
Non Dimmable	60.9160	60.9592
Dimmable 0/1-10V	60.9188	60.9188
Dimmable Dali 1	60.8847	60.8847
Dimmable Dali 2	60.9222	60.9222
Mains Dimming	60.9411	60.9467
Casambi	60.9207	60.9207

* Siehe Treiberkapitel / Refer to the Drivers chapter

- 2700K**
Easy Kap 80 Square
□ 03.4177.B1
Easy Kap 80 Plus Square
□ 05.7407.B1

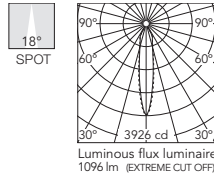

Beam Angle: 18°

h(m)	E(lx)	D(m)
1	3926 0.31	
2	981 0.62	
3	436 0.94	
4	245 1.25	
5	157 1.56	

Luminous flux luminaire
1096 lm (EXTREME CUT OFF)

- 3000K**
Easy Kap 80 Square
□ 03.4176.B1
Easy Kap 80 Plus Square
□ 05.7406.B1

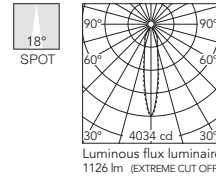

Beam Angle: 18°

h(m)	E(lx)	D(m)
1	4034 0.31	
2	1009 0.62	
3	448 0.94	
4	252 1.25	
5	161 1.56	

Luminous flux luminaire
1126 lm (EXTREME CUT OFF)

- Easy Kap 80 Square
■ 03.4177.GL
Easy Kap 80 Plus Square
■ 05.7407.GL

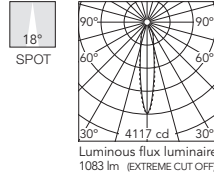

Beam Angle: 18°

h(m)	E(lx)	D(m)
1	4117 0.31	
2	1029 0.63	
3	457 0.94	
4	257 1.26	
5	165 1.57	

Luminous flux luminaire
1083 lm (EXTREME CUT OFF)

- Easy Kap 80 Square
■ 03.4176.GL
Easy Kap 80 Plus Square
■ 05.7406.GL

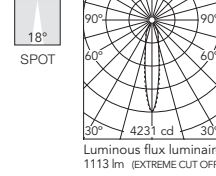

Beam Angle: 18°

h(m)	E(lx)	D(m)
1	4231 0.31	
2	1058 0.63	
3	470 0.94	
4	264 1.26	
5	169 1.57	

Luminous flux luminaire
1113 lm (EXTREME CUT OFF)

- Easy Kap 80 Square
■ 03.4177.BU
Easy Kap 80 Plus Square
■ 05.7407.BU

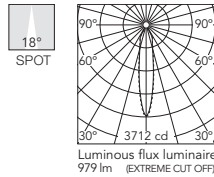

Beam Angle: 18°

h(m)	E(lx)	D(m)
1	3712 0.32	
2	928 0.64	
3	412 0.96	
4	232 1.28	
5	148 1.60	

Luminous flux luminaire
979 lm (EXTREME CUT OFF)

- Easy Kap 80 Square
■ 03.4176.BU
Easy Kap 80 Plus Square
■ 05.7406.BU

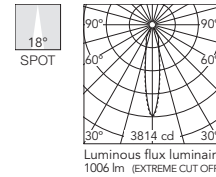

Beam Angle: 18°

h(m)	E(lx)	D(m)
1	3814 0.32	
2	954 0.64	
3	424 0.96	
4	238 1.28	
5	153 1.60	

Luminous flux luminaire
1006 lm (EXTREME CUT OFF)

- Easy Kap 80 Square
■ 03.4177.74
Easy Kap 80 Plus Square
■ 05.7407.74

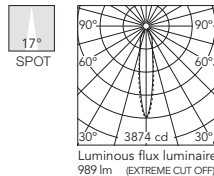

Beam Angle: 17°

h(m)	E(lx)	D(m)
1	3874 0.30	
2	969 0.60	
3	430 0.90	
4	242 1.20	
5	155 1.50	

Luminous flux luminaire
989 lm (EXTREME CUT OFF)

- Easy Kap 80 Square
■ 03.4176.74
Easy Kap 80 Plus Square
■ 05.7406.74

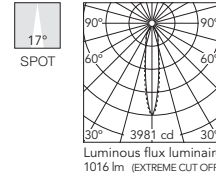

Beam Angle: 17°

h(m)	E(lx)	D(m)
1	3981 0.30	
2	995 0.60	
3	442 0.90	
4	249 1.20	
5	159 1.50	

Luminous flux luminaire
1016 lm (EXTREME CUT OFF)

- Easy Kap 80 Square
■ 03.4177.CU
Easy Kap 80 Plus Square
■ 05.7407.CU

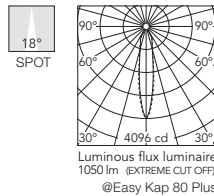

Beam Angle: 18°

h(m)	E(lx)	D(m)
1	4096 0.31	
2	1024 0.62	
3	455 0.94	
4	256 1.25	
5	164 1.56	

Luminous flux luminaire
1050 lm (EXTREME CUT OFF)
@Easy Kap 80 Plus

- Easy Kap 80 Square
■ 03.4176.CU
Easy Kap 80 Plus Square
■ 05.7406.CU

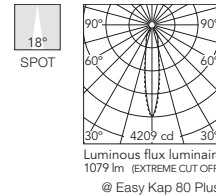

Beam Angle: 18°

h(m)	E(lx)	D(m)
1	4209 0.31	
2	1052 0.62	
3	468 0.94	
4	263 1.25	
5	168 1.56	

Luminous flux luminaire
1079 lm (EXTREME CUT OFF)
@ Easy Kap 80 Plus

Easy Kap 80 Square Fixed - Optic Spot - Dim To Warm

Light Source: LED Array 13W - 1800K - 2850K/CRI 95 - Dim To Warm

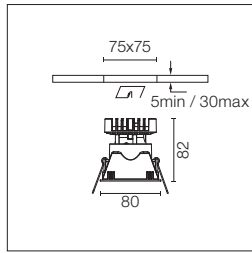

	GWT 850°	IP 54
0,24 Kg	03	F
h=93 mm		

LED Einbauleuchte. 220-240V und dimmbares 1-10V Netzteil inklusive. Für Versionen mit 110-V-Geräten wenden Sie sich an das Frontoffice. Installationsrahmen nicht notwendig. Diffusorlinse inbegriffen.

Recessed luminaire with LED light source. 220-240V & dimmable 1-10V power supply included. For 110V PSU versions, please consult with the front office. Installation frame not necessary. Diffusing lens included.

1800K-2850K
 03.4176.B1.LE

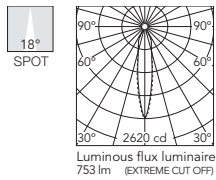

h(m)	E(lx)	D(m)
1	2620	0.32
2	655	0.64
3	291	0.96
4	164	1.28
5	105	1.60

03.4176.GL.LE

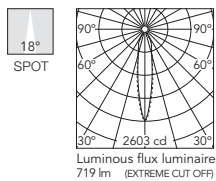

h(m)	E(lx)	D(m)
1	2603	0.32
2	651	0.64
3	289	0.96
4	163	1.28
5	104	1.60

03.4176.BU.LE

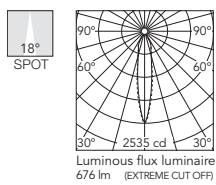

h(m)	E(lx)	D(m)
1	2535	0.31
2	634	0.63
3	282	0.94
4	158	1.26
5	101	1.57

03.4176.74.LE

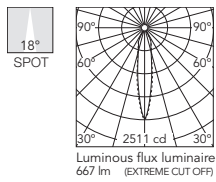

h(m)	E(lx)	D(m)
1	2511	0.31
2	628	0.63
3	279	0.94
4	157	1.25
5	100	1.57

03.4176.CU.LE

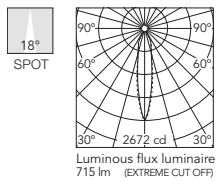

h(m)	E(lx)	D(m)
1	2672	0.32
2	668	0.64
3	297	0.96
4	167	1.29
5	107	1.61

KAP

Easy Kap 80 Square/Easy Kap 80 Square Plus - Fixed - Optic Medium

Light Source: Easy Kap 80 Square LED Array DC 500 mA - 9,2W - 935 lm - 2700K/CRI 90 / 9,2W - 974 lm - 3000K/CRI 90

Easy Kap 80 Square Plus: LED Array DC 700 mA - 13W - 1370 lm - 2700K/CRI 90 / 13W - 1460 lm - 3000K/CRI 90

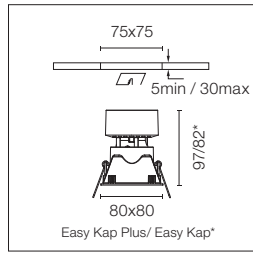

LED Einbauleuchte. Ohne Netzgerät. Installationsrahmen nicht notwendig. Diffusorlinse inbegriffen. Recessed luminaire with LED light source. Power supply not included. Installation frame not necessary. Diffusing lens included.

Empfohlene Netzgeräte / Recommended power supply*:

	Easy Kap 80	Easy Kap 80 Plus
Non Dimmable	60.9160	60.9592
Dimmable 0/1-10V	60.9188	60.9188
Dimmable Dali 1	60.8847	60.8847
Dimmable Dali 2	60.9222	60.9222
Mains Dimming	60.9411	60.9467
Casambi	60.9207	60.9207

* Siehe Treiberkapitel / Refer to the Drivers chapter

- 2700K**
Easy Kap 80 Square
□ 03.4195.B1
Easy Kap 80 Plus Square
□ 05.7433.B1

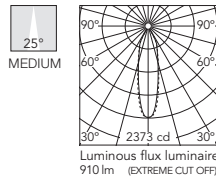

h(m)	E(lx)	D(m)
1	2373	0.45
2	593	0.90
3	264	1.34
4	148	1.79
5	95	2.24

- 3000K**
Easy Kap 80 Square
□ 03.4194.B1
Easy Kap 80 Plus Square
□ 05.7432.B1

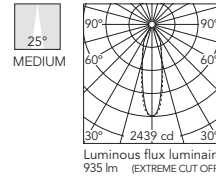

h(m)	E(lx)	D(m)
1	2439	0.45
2	610	0.90
3	271	1.34
4	152	1.79
5	98	2.24

- Easy Kap 80 Square
■ 03.4195.GL
Easy Kap 80 Plus Square
■ 05.7433.GL

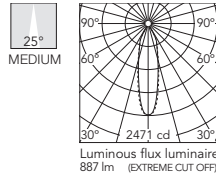

h(m)	E(lx)	D(m)
1	2471	0.45
2	618	0.90
3	275	1.34
4	154	1.79
5	99	2.24

- Easy Kap 80 Square
■ 03.4194.GL
Easy Kap 80 Plus Square
■ 05.7432.GL

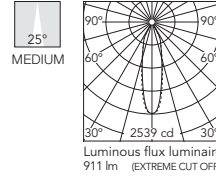

h(m)	E(lx)	D(m)
1	2539	0.45
2	635	0.90
3	282	1.34
4	159	1.79
5	102	2.24

- Easy Kap 80 Square
■ 03.4195.BU
Easy Kap 80 Plus Square
■ 05.7433.BU

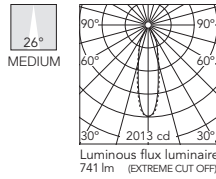

h(m)	E(lx)	D(m)
1	2013	0.45
2	503	0.91
3	224	1.36
4	126	1.82
5	81	2.27

- Easy Kap 80 Square
■ 03.4194.BU
Easy Kap 80 Plus Square
■ 05.7432.BU

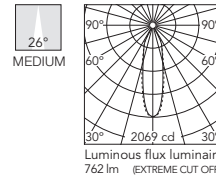

h(m)	E(lx)	D(m)
1	2069	0.45
2	517	0.91
3	230	1.36
4	129	1.82
5	83	2.27

- Easy Kap 80 Square
■ 03.4195.74
Easy Kap 80 Plus Square
■ 05.7433.74

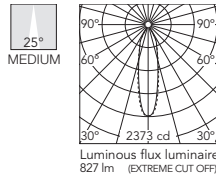

h(m)	E(lx)	D(m)
1	2373	0.44
2	593	0.88
3	264	1.32
4	148	1.76
5	95	2.20

- Easy Kap 80 Square
■ 03.4194.74
Easy Kap 80 Plus Square
■ 05.7432.74

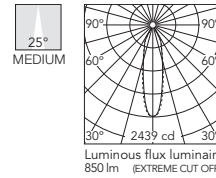

h(m)	E(lx)	D(m)
1	2439	0.44
2	610	0.88
3	271	1.32
4	152	1.76
5	98	2.20

- Easy Kap 80 Square
■ 03.4195.CU
Easy Kap 80 Plus Square
■ 05.7433.CU

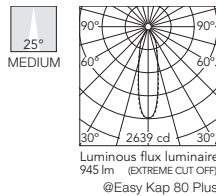

h(m)	E(lx)	D(m)
1	2639	0.44
2	660	0.88
3	293	1.32
4	165	1.75
5	106	2.19

- Easy Kap 80 Square
■ 03.4194.CU
Easy Kap 80 Plus Square
■ 05.7432.CU

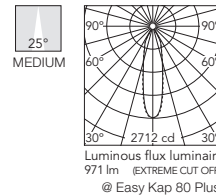

h(m)	E(lx)	D(m)
1	2712	0.44
2	678	0.88
3	301	1.32
4	169	1.75
5	108	2.19

Easy Kap 80 Square Fixed - Optic Medium - Dim To Warm

Light Source: LED Array 13W - 1800K - 2850K/CRI 95 - Dim To Warm

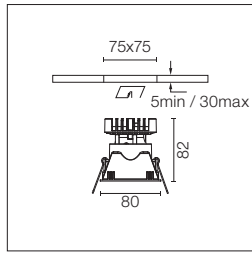

GWT 850°
 IP 54
 0,24 Kg
 03
 F
 h-93 min
 LED INCL
 CE

LED Einbauleuchte. 220-240V und dimmbares 1-10V Netzteil inklusive. Für Versionen mit 110-V-Geräten wenden Sie sich an das Frontoffice. Installationsrahmen nicht notwendig. Diffusorlinse inbegriffen.

Recessed luminaire with LED light source. 220-240V & dimmable 1-10V power supply included. For 110V PSU versions, please consult with the front office. Installation frame not necessary. Diffusing lens included.

1800K-2850K
 03.4194.B1.LE

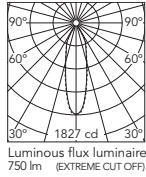

Beam Angle: 27°

h(m)	E(lx)	D(m)
1	1827	0.48
2	457	0.96
3	203	1.45
4	114	1.93
5	73	2.41

03.4194.GL.LE

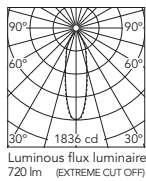

Beam Angle: 27°

h(m)	E(lx)	D(m)
1	1836	0.49
2	459	0.98
3	204	1.47
4	115	1.95
5	73	2.44

03.4194.BU.LE

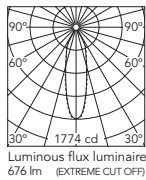

Beam Angle: 27°

h(m)	E(lx)	D(m)
1	1774	0.48
2	444	0.96
3	197	1.44
4	111	1.92
5	71	2.40

03.4194.74.LE

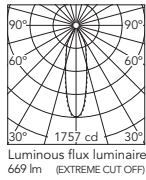

Beam Angle: 27°

h(m)	E(lx)	D(m)
1	1757	0.48
2	439	0.96
3	195	1.44
4	110	1.93
5	70	2.41

03.4194.CU.LE

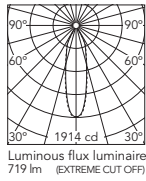

Beam Angle: 27°

h(m)	E(lx)	D(m)
1	1914	0.48
2	478	0.95
3	213	1.43
4	120	1.90
5	77	2.38

KAP

Easy Kap 80 Square/Easy Kap 80 Square Plus - Fixed - Optic Flood

Light Source: Easy Kap 80 Square: LED Array DC 500 mA - 9,2W - 935 lm - 2700K/CRI 90 / 9,2W - 974 lm - 3000K/CRI 90

Easy Kap 80 Square Plus: LED Array DC 700 mA - 13W - 1370 lm - 2700K/CRI 90 / 13W - 1460 lm - 3000K/CRI 90

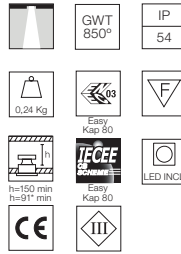
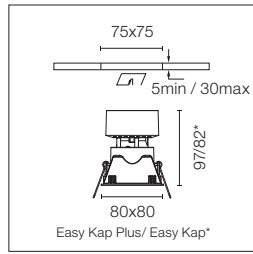

LED Einbauleuchte. Ohne Netzgerät. Installationsrahmen nicht notwendig. Diffusorlinse inbegriffen. Recessed luminaire with LED light source. Power supply not included. Installation frame not necessary. Diffusing lens included.

Empfohlene Netzgeräte / Recommended power supply*:

	Easy Kap 80	Easy Kap 80 Plus
Non Dimmable	60.9160	60.9592
Dimmable 0/1-10V	60.9188	60.9188
Dimmable Dali 1	60.8847	60.8847
Dimmable Dali 2	60.9222	60.9222
Mains Dimming	60.9411	60.9467
Casambi	60.9207	60.9207

* Siehe Treiberkapitel / Refer to the Drivers chapter

- 2700K**
Easy Kap 80 Square
□ 03.4179.B1
Easy Kap 80 Plus Square
□ 05.7409.B1

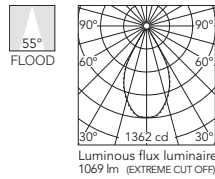

Beam Angle: 55°

h(m)	Et(x)	D(m)
1	1362	1.03
2	340	2.07
3	151	3.10
4	85	4.14
5	54	5.17

Luminous flux luminaire
1069 lm (EXTREME CUT OFF)

- 3000K**
Easy Kap 80 Square
□ 03.4178.B1
Easy Kap 80 Plus Square
□ 05.7408.B1

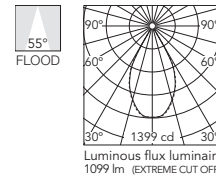

Beam Angle: 55°

h(m)	Et(x)	D(m)
1	1399	1.03
2	350	2.07
3	155	3.10
4	87	4.14
5	56	5.17

Luminous flux luminaire
1099 lm (EXTREME CUT OFF)

- Easy Kap 80 Square
■ 03.4179.GL
Easy Kap 80 Plus Square
■ 05.7409.GL

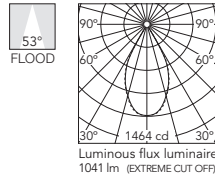

Beam Angle: 53°

h(m)	Et(x)	D(m)
1	1464	1.00
2	366	2.00
3	163	3.00
4	92	4.00
5	59	5.01

Luminous flux luminaire
1041 lm (EXTREME CUT OFF)

- Easy Kap 80 Square
■ 03.4178.GL
Easy Kap 80 Plus Square
■ 05.7408.GL

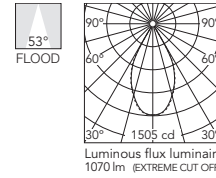

Beam Angle: 53°

h(m)	Et(x)	D(m)
1	1505	1.00
2	376	2.00
3	167	3.00
4	94	4.00
5	60	5.01

Luminous flux luminaire
1070 lm (EXTREME CUT OFF)

- Easy Kap 80 Square
■ 03.4179.BU
Easy Kap 80 Plus Square
■ 05.7409.BU

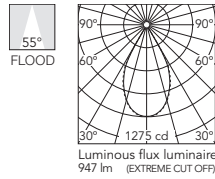

Beam Angle: 55°

h(m)	Et(x)	D(m)
1	1275	1.04
2	319	2.09
3	142	3.13
4	80	4.18
5	51	5.22

Luminous flux luminaire
947 lm (EXTREME CUT OFF)

- Easy Kap 80 Square
■ 03.4178.BU
Easy Kap 80 Plus Square
■ 05.7408.BU

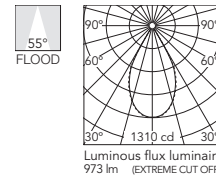

Beam Angle: 55°

h(m)	Et(x)	D(m)
1	1310	1.04
2	327	2.09
3	146	3.13
4	82	4.18
5	52	5.22

Luminous flux luminaire
973 lm (EXTREME CUT OFF)

- Easy Kap 80 Square
■ 03.4179.74
Easy Kap 80 Plus Square
■ 05.7409.74

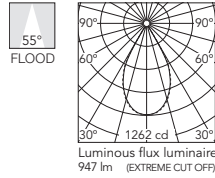

Beam Angle: 55°

h(m)	Et(x)	D(m)
1	1262	1.05
2	315	2.10
3	140	3.16
4	79	4.21
5	50	5.26

Luminous flux luminaire
947 lm (EXTREME CUT OFF)

- Easy Kap 80 Square
■ 03.4178.74
Easy Kap 80 Plus Square
■ 05.7408.74

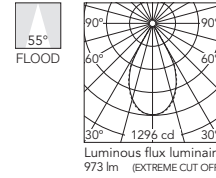

Beam Angle: 55°

h(m)	Et(x)	D(m)
1	1296	1.05
2	324	2.10
3	144	3.16
4	81	4.21
5	52	5.26

Luminous flux luminaire
973 lm (EXTREME CUT OFF)

- Easy Kap 80 Square
■ 03.4179.CU
Easy Kap 80 Plus Square
■ 05.7409.CU

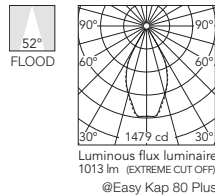

Beam Angle: 52°

h(m)	Et(x)	D(m)
1	1479	0.97
2	370	1.93
3	164	2.90
4	92	3.87
5	59	4.84

Luminous flux luminaire
1013 lm (EXTREME CUT OFF)
@Easy Kap 80 Plus

- Easy Kap 80 Square
■ 03.4178.CU
Easy Kap 80 Plus Square
■ 05.7408.CU

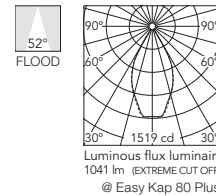

Beam Angle: 52°

h(m)	Et(x)	D(m)
1	1519	0.97
2	380	1.93
3	169	2.90
4	95	3.87
5	61	4.84

Luminous flux luminaire
1041 lm (EXTREME CUT OFF)
@ Easy Kap 80 Plus

Easy Kap 80 Square Fixed - Optic Flood - Dim To Warm

Light Source: LED Array 13W - 1800K - 2850K/CRI 95 - Dim To Warm

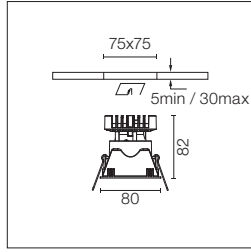

	GWT 850°		IP 54
	0,24 Kg		03
	h-93 mm		LED INCL
	CE		TECSEE

LED Einbauleuchte. 220-240V und dimmbares 1-10V Netzteil inklusive. Für Versionen mit 110-V-Geräten wenden Sie sich an das Frontoffice. Installationsrahmen nicht notwendig. Diffusorlinse inbegriffen.

Recessed luminaire with LED light source. 220-240V & dimmable 1-10V power supply included. For 110V PSU versions, please consult with the front office. Installation frame not necessary. Diffusing lens included.

1800K-2850K
 03.4178.B1.LE

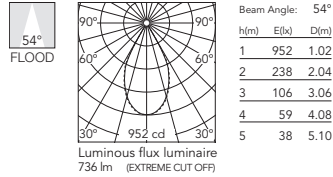

03.4178.GL.LE

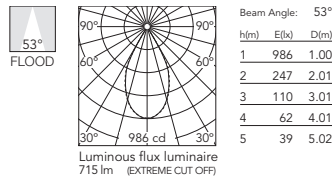

03.4178.BU.LE

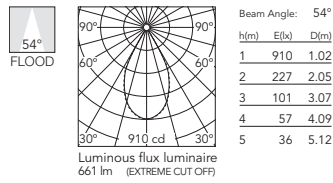

03.4178.74.LE

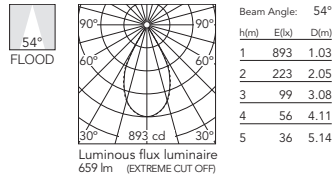

03.4178.CU.LE

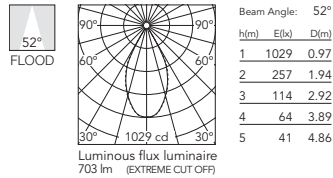

Easy Kap Ø80 Fixed

Light Source: LED QR-CBC 51 GX5.3

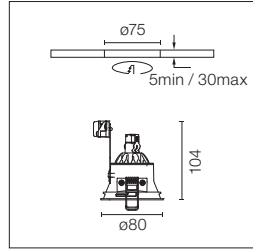

GWT 850°
 0,12 Kg

 IP 23
 h=130 min

Einbauleuchte für 12V lampe. Separater Transformator nicht inbegriffen. Installationsrahmen nicht notwendig. Objektivzubehör nicht erhältlich.

Recessed 12V lamp luminaire. Remote transformer not included. Installation frame not necessary. Not suitable for lens accessories.

- 03.4210.B1
- 03.4210.GL
- 03.4210.BU
- 03.4210.74
- 03.4210.CU

Easy Kap 80 Square Fixed

Light Source: LED QR-CBC 51 GX5.3

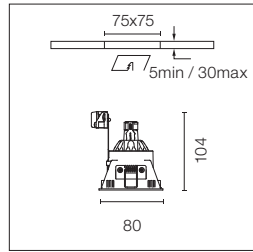

GWT 850°
 0,12 Kg

 IP 23
 h=130 min

Einbauleuchte für 12V lampe. Separater Transformator nicht inbegriffen. Installationsrahmen nicht notwendig. Objektivzubehör nicht erhältlich.

Recessed 12V lamp luminaire. Remote transformer not included. Installation frame not necessary. Not suitable for lens accessories.

- 03.4208.B1
- 03.4208.GL
- 03.4208.BU
- 03.4208.74
- 03.4208.CU

Easy Kap Ø80 Fixed

Light Source: LED PAR 16 GZ10

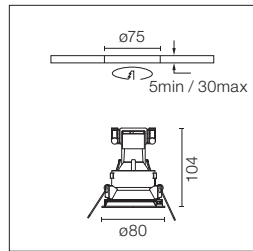

GWT 850°
 0,12 Kg

 IP 23
 h=155 min

Einbauleuchte für Netzspannung. Installationsrahmen nicht notwendig. Objektivzubehör nicht erhältlich.

Recessed luminaire with main voltage source. Installation frame not necessary. Not suitable for lens accessories.

- 03.4211.B1
- 03.4211.GL
- 03.4211.BU
- 03.4211.74
- 03.4211.CU

Easy Kap 80 Square Fixed

Light Source: LED PAR 16 GZ10

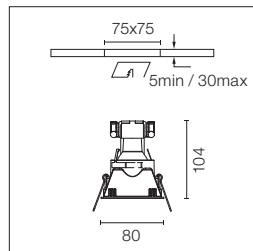

GWT 850°
 0,12 Kg

 IP 23
 h=155 min

Einbauleuchte für Netzspannung. Installationsrahmen nicht notwendig. Objektivzubehör nicht erhältlich.

Recessed luminaire with main voltage source. Installation frame not necessary. Not suitable for lens accessories.

- 03.4209.B1
- 03.4209.GL
- 03.4209.BU
- 03.4209.74
- 03.4209.CU

KAP

Easy Kap Ø80/Easy Kap Ø80 Plus - Adjustable - Optic Spot

Light Source: Easy Kap Ø80: LED Array DC 500 mA - 9,2W - 935 lm - 2700K/CRI 90 / 9,2W - 974 lm - 3000K/CRI 90
Easy Kap Ø80 Plus: LED Array DC 700 mA - 13W - 1370 lm - 2700K/CRI 90 / 13W - 1460 lm - 3000K/CRI 90

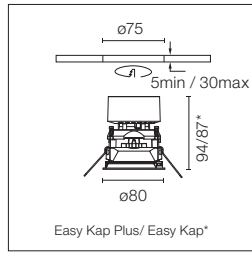

LED Einbauleuchte. Ohne Netzgerät. Installationsrahmen nicht notwendig. Diffusorlinse inbegriffen.
 Recessed luminaire with LED light source. Power supply not included. Installation frame not necessary. Diffusing lens included.

Empfohlene Netzgeräte / Recommended power supply*:

	Easy Kap Ø80	Easy Kap Ø80 Plus
Non Dimmable	60.9160	60.9592
Dimmable 0/1-10V	60.9188	60.9188
Dimmable Dali 1	60.8847	60.8847
Dimmable Dali 2	60.9222	60.9222
Mains Dimming	60.9411	60.9467
Casambi	60.9207	60.9207

* Siehe Treiberkapitel / Refer to the Drivers chapter

- 2700K**
 Easy Kap Ø80
 03.4153.B1
 Easy Kap Ø80 Plus
 05.7400.B1

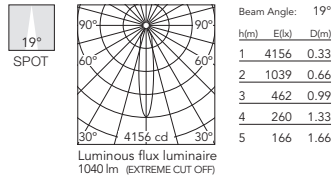

- 3000K**
 Easy Kap Ø80
 03.4170.B1
 Easy Kap Ø80 Plus
 05.7403.B1

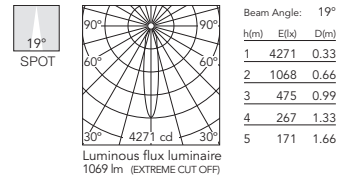

- Easy Kap Ø80
 03.4153.GL
 Easy Kap Ø80 Plus
 05.7400.GL

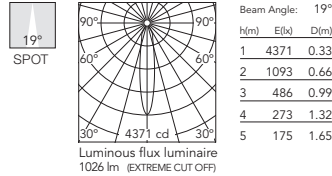

- Easy Kap Ø80
 03.4170.GL
 Easy Kap Ø80 Plus
 05.7403.GL

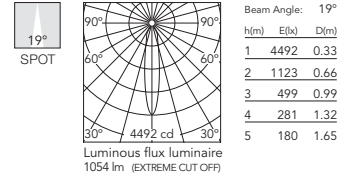

- Easy Kap Ø80
 03.4153.BU
 Easy Kap Ø80 Plus
 05.7400.BU

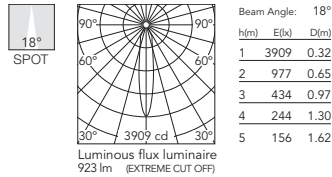

- Easy Kap Ø80
 03.4170.BU
 Easy Kap Ø80 Plus
 05.7403.BU

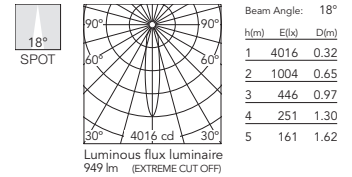

- Easy Kap Ø80
 03.4153.74
 Easy Kap Ø80 Plus
 05.7400.74

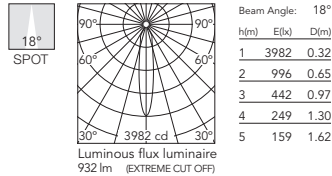

- Easy Kap Ø80
 03.4170.74
 Easy Kap Ø80 Plus
 05.7403.74

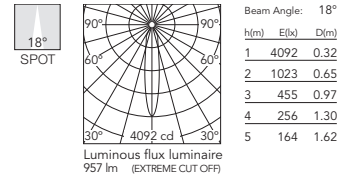

- Easy Kap Ø80
 03.4153.CU
 Easy Kap Ø80 Plus
 05.7400.CU

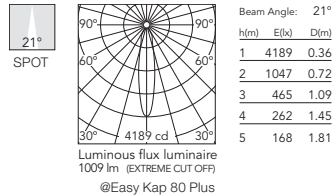

- Easy Kap Ø80
 03.4170.CU
 Easy Kap Ø80 Plus
 05.7403.CU

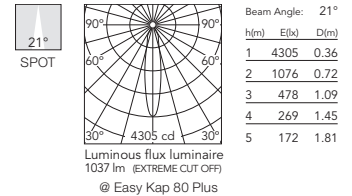

Easy Kap Ø80 Adjustable - Optic Spot - Dim To Warm

Light Source: LED Array 13W - 1800K - 2850K/CRI 95 - Dim To Warm

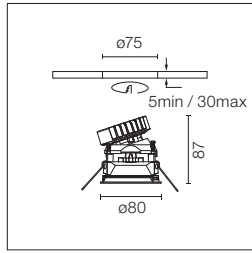

LED Einbauleuchte. 220-240V und dimmbares 1-10V Netzteil inklusive. Für Versionen mit 110-V-Geräten wenden Sie sich an das Frontoffice. Installationsrahmen nicht notwendig. Diffusorlinse inbegriffen.

Recessed luminaire with LED light source. 220-240V & dimmable 1-10V power supply included. For 110V PSU versions, please consult with the front office. Installation frame not necessary. Diffusing lens included.

1800K-2850K
 03.4170.B1.LE

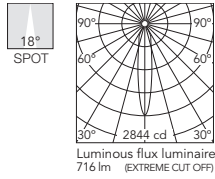

Beam Angle: 18°

h(m)	E(lx)	D(m)
1	2844	0.31
2	711	0.63
3	316	0.94
4	178	1.25
5	114	1.56

03.4170.GL.LE

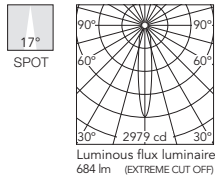

Beam Angle: 17°

h(m)	E(lx)	D(m)
1	2979	0.30
2	745	0.61
3	331	0.91
4	186	1.21
5	119	1.52

03.4170.BU.LE

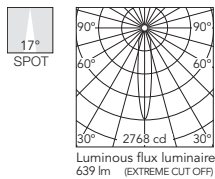

Beam Angle: 17°

h(m)	E(lx)	D(m)
1	2768	0.31
2	692	0.61
3	308	0.92
4	173	1.22
5	111	1.53

03.4170.74.LE

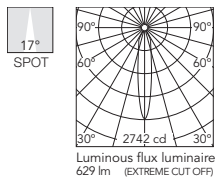

Beam Angle: 17°

h(m)	E(lx)	D(m)
1	2742	0.31
2	686	0.61
3	305	0.92
4	171	1.22
5	110	1.53

03.4170.CU.LE

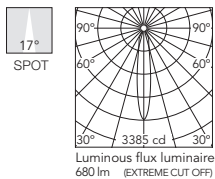

Beam Angle: 17°

h(m)	E(lx)	D(m)
1	3385	0.30
2	846	0.60
3	376	0.90
4	212	1.20
5	135	1.50

K AP

Easy Kap Ø80/Easy Kap Ø80 Plus - Adjustable - Optic Medium

Light Source: Easy Kap Ø80: LED Array DC 500 mA - 9,2W - 935 lm - 2700K/CRI 90 / 9,2W - 974 lm - 3000K/CRI 90
Easy Kap Ø80 Plus: LED Array DC 700 mA - 13W - 1370 lm - 2700K/CRI 90 / 13W - 1460 lm - 3000K/CRI 90

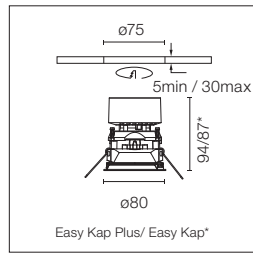

LED Einbauleuchte. Ohne Netzgerät. Installationsrahmen nicht notwendig. Diffusorlinse inbegriffen.
 Recessed luminaire with LED light source. Power supply not included. Installation frame not necessary. Diffusing lens included.

Empfohlene Netzgeräte / Recommended power supply*:

	Easy Kap Ø80	Easy Kap Ø80 Plus
Non Dimmable	60.9160	60.9592
Dimmable 0/1-10V	60.9188	60.9188
Dimmable Dali 1	60.8847	60.8847
Dimmable Dali 2	60.9222	60.9222
Mains Dimming	60.9411	60.9467
Casambi	60.9207	60.9207

* Siehe Treiberkapitel / Refer to the Drivers chapter

- 2700K**
 Easy Kap Ø80
 03.4155.B1
 Easy Kap Ø80 Plus
 05.7401.B1

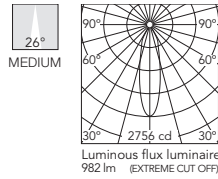

Beam Angle: 26°

h(m)	E(lx)	D(m)
1	2756	0.47
2	689	0.93
3	306	1.40
4	172	1.87
5	110	2.33

Luminous flux luminaire
982 lm (EXTREME CUT OFF)

- 3000K**
 Easy Kap Ø80
 03.4171.B1
 Easy Kap Ø80 Plus
 05.7404.B1

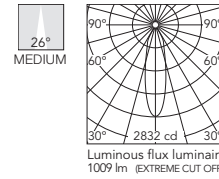

Beam Angle: 26°

h(m)	E(lx)	D(m)
1	2832	0.47
2	708	0.93
3	315	1.40
4	177	1.87
5	113	2.33

Luminous flux luminaire
1009 lm (EXTREME CUT OFF)

- Easy Kap Ø80
 03.4155.GL
 Easy Kap Ø80 Plus
 05.7401.GL

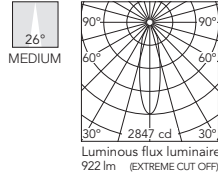

Beam Angle: 26°

h(m)	E(lx)	D(m)
1	2847	0.46
2	712	0.93
3	316	1.39
4	178	1.85
5	114	2.32

Luminous flux luminaire
922 lm (EXTREME CUT OFF)

- Easy Kap Ø80
 03.4171.GL
 Easy Kap Ø80 Plus
 05.7404.GL

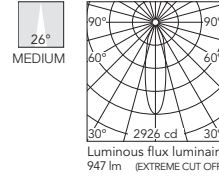

Beam Angle: 26°

h(m)	E(lx)	D(m)
1	2926	0.46
2	731	0.93
3	325	1.39
4	183	1.85
5	117	2.32

Luminous flux luminaire
947 lm (EXTREME CUT OFF)

- Easy Kap Ø80
 03.4155.BU
 Easy Kap Ø80 Plus
 05.7401.BU

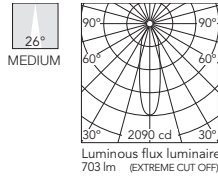

Beam Angle: 26°

h(m)	E(lx)	D(m)
1	2090	0.47
2	522	0.94
3	232	1.40
4	131	1.87
5	84	2.34

Luminous flux luminaire
703 lm (EXTREME CUT OFF)

- Easy Kap Ø80
 03.4171.BU
 Easy Kap Ø80 Plus
 05.7404.BU

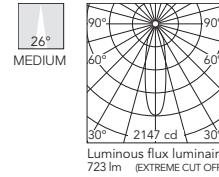

Beam Angle: 26°

h(m)	E(lx)	D(m)
1	2147	0.47
2	537	0.94
3	239	1.40
4	134	1.87
5	86	2.34

Luminous flux luminaire
723 lm (EXTREME CUT OFF)

- Easy Kap Ø80
 03.4155.74
 Easy Kap Ø80 Plus
 05.7401.74

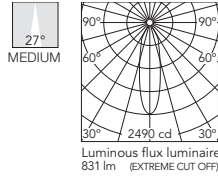

Beam Angle: 27°

h(m)	E(lx)	D(m)
1	2490	0.47
2	622	0.95
3	277	1.42
4	156	1.89
5	100	2.37

Luminous flux luminaire
831 lm (EXTREME CUT OFF)

- Easy Kap Ø80
 03.4171.74
 Easy Kap Ø80 Plus
 05.7404.74

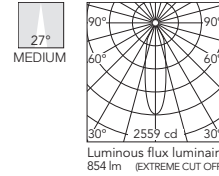

Beam Angle: 27°

h(m)	E(lx)	D(m)
1	2559	0.47
2	640	0.95
3	284	1.42
4	160	1.89
5	102	2.37

Luminous flux luminaire
854 lm (EXTREME CUT OFF)

- Easy Kap Ø80
 03.4155.CU
 Easy Kap Ø80 Plus
 05.7401.CU

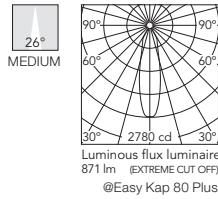

Beam Angle: 26°

h(m)	E(lx)	D(m)
1	2780	0.47
2	695	0.93
3	309	1.40
4	174	1.86
5	111	2.33

Luminous flux luminaire
871 lm (EXTREME CUT OFF)
 @Easy Kap 80 Plus

- Easy Kap Ø80
 03.4171.CU
 Easy Kap Ø80 Plus
 05.7404.CU

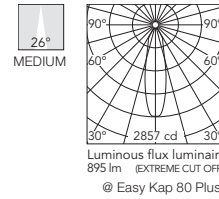

Beam Angle: 26°

h(m)	E(lx)	D(m)
1	2857	0.47
2	714	0.93
3	317	1.40
4	179	1.86
5	114	2.33

Luminous flux luminaire
895 lm (EXTREME CUT OFF)
 @ Easy Kap 80 Plus

KAP

Easy Kap Ø80 Adjustable - Optic Medium - Dim To Warm

Light Source: LED Array 13W - 1800K - 2850K/CRI 95 - Dim To Warm

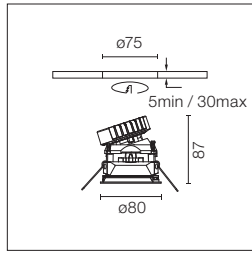

LED Einbauleuchte. 220-240V und dimmbares 1-10V Netzteil inklusive. Für Versionen mit 110-V-Geräten wenden Sie sich an das Frontoffice. Installationsrahmen nicht notwendig. Diffusorlinse inbegriffen.

Recessed luminaire with LED light source. 220-240V & dimmable 1-10V power supply included. For 110V PSU versions, please consult with the front office. Installation frame not necessary. Diffusing lens included.

1800K-2850K
 03.4171.B1.LE

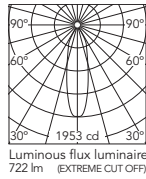

Beam Angle: 27°

h(m)	E(lx)	D(m)
1	1953	0.48
2	488	0.97
3	217	1.45
4	122	1.94
5	78	2.42

03.4171.GL.LE

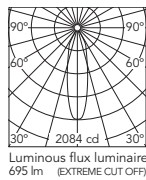

Beam Angle: 26°

h(m)	E(lx)	D(m)
1	2084	0.46
2	521	0.92
3	232	1.38
4	130	1.85
5	83	2.31

03.4171.BU.LE

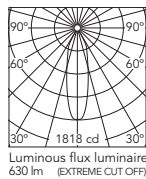

Beam Angle: 28°

h(m)	E(lx)	D(m)
1	1818	0.49
2	454	0.98
3	202	1.47
4	114	1.96
5	73	2.45

03.4171.74.LE

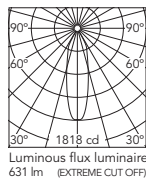

Beam Angle: 28°

h(m)	E(lx)	D(m)
1	1818	0.49
2	455	0.99
3	202	1.48
4	114	1.97
5	73	2.46

03.4171.CU.LE

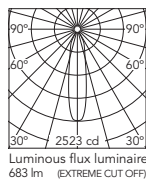

Beam Angle: 22°

h(m)	E(lx)	D(m)
1	2523	0.39
2	631	0.78
3	280	1.17
4	158	1.56
5	101	1.95

K AP

Easy Kap Ø80/Easy Kap Ø80 Plus - Adjustable - Optic Flood

Light Source: Easy Kap Ø80: LED Array DC 500 mA - 9,2W - 935 lm - 2700K/CRI 90 / 9,2W - 974 lm - 3000K/CRI 90
Easy Kap Ø80 Plus: LED Array DC 700 mA - 13W - 1370 lm - 2700K/CRI 90 / 13W - 1460 lm - 3000K/CRI 90

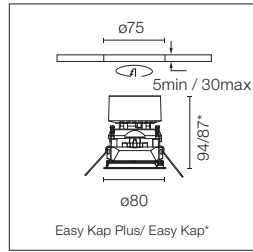

LED Einbauleuchte. Ohne Netzgerät. Installationsrahmen nicht notwendig. Diffusorlinse inbegriffen.
 Recessed luminaire with LED light source. Power supply not included. Installation frame not necessary. Diffusing lens included.

Empfohlene Netzgeräte / Recommended power supply*:

	Easy Kap Ø80	Easy Kap Ø80 Plus
Non Dimmable	60.9160	60.9592
Dimmable 0/1-10V	60.9188	60.9188
Dimmable Dali 1	60.8847	60.8847
Dimmable Dali 2	60.9222	60.9222
Mains Dimming	60.9411	60.9467
Casambi	60.9207	60.9207

* Siehe Treiberkapitel / Refer to the Drivers chapter

- 2700K**
 Easy Kap Ø80
 03.4157.B1
 Easy Kap Ø80 Plus
 05.7402.B1

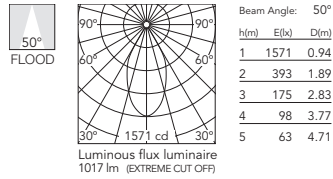

- 3000K**
 Easy Kap Ø80
 03.4172.B1
 Easy Kap Ø80 Plus
 05.7405.B1

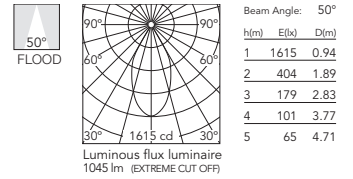

- Easy Kap Ø80
 03.4157.GL
 Easy Kap Ø80 Plus
 05.7402.GL

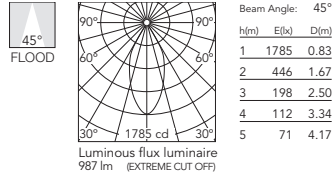

- Easy Kap Ø80
 03.4172.GL
 Easy Kap Ø80 Plus
 05.7405.GL

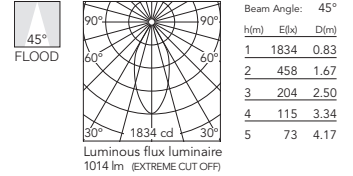

- Easy Kap Ø80
 03.4157.BU
 Easy Kap Ø80 Plus
 05.7402.BU

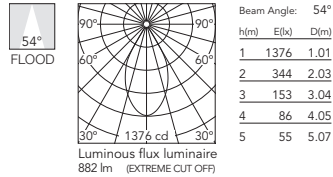

- Easy Kap Ø80
 03.4172.BU
 Easy Kap Ø80 Plus
 05.7405.BU

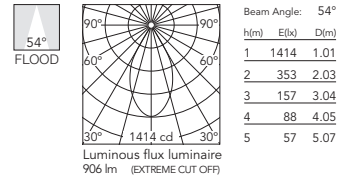

- Easy Kap Ø80
 03.4157.74
 Easy Kap Ø80 Plus
 05.7402.74

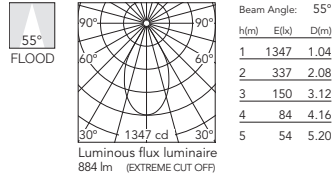

- Easy Kap Ø80
 03.4172.74
 Easy Kap Ø80 Plus
 05.7405.74

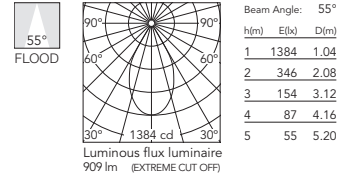

- Easy Kap Ø80
 03.4157.CU
 Easy Kap Ø80 Plus
 05.7402.CU

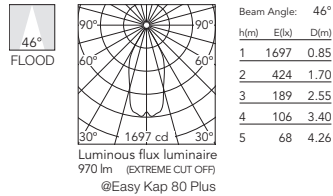

- Easy Kap Ø80
 03.4172.CU
 Easy Kap Ø80 Plus
 05.7405.CU

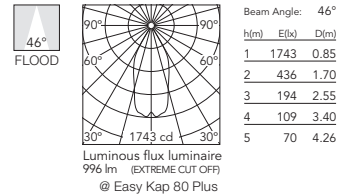

Easy Kap Ø80 Adjustable - Optic Flood - Dim To Warm

Light Source: LED Array 13W - 1800K - 2850K/CRI 95 - Dim To Warm

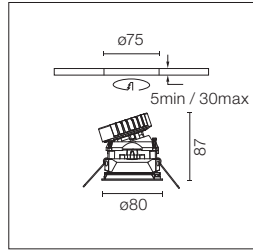

LED Einbauleuchte. 220-240V und dimmbares 1-10V Netzteil inklusive. Für Versionen mit 110-V-Geräten wenden Sie sich an das Frontoffice. Installationsrahmen nicht notwendig. Diffusorlinse inbegriffen.

Recessed luminaire with LED light source. 220-240V & dimmable 1-10V power supply included. For 110V PSU versions, please consult with the front office. Installation frame not necessary. Diffusing lens included.

1800K-2850K
 03.4172.B1.LE

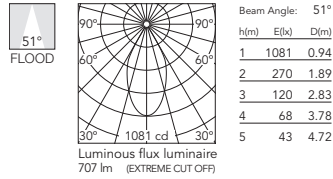

03.4172.GL.LE

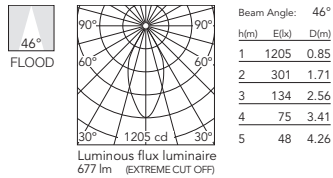

03.4172.BU.LE

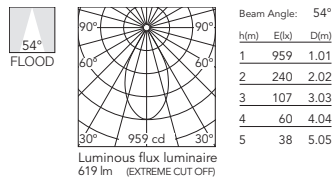

03.4172.74.LE

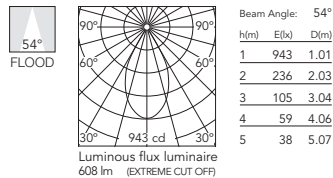

03.4172.CU.LE

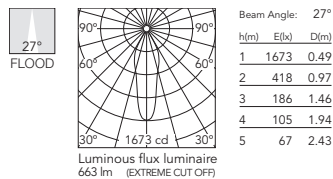

KAP

Easy Kap 80 Square/Easy Kap 80 Square Plus - Adjustable - Optic Spot

Light Source: Easy Kap 80 Square: LED Array DC 500 mA - 9,2W - 935 lm - 2700K/CRI 90 / 9,2W - 974 lm - 3000K/CRI 90

Easy Kap 80 Square Plus: LED Array DC 700 mA - 13W - 1370 lm - 2700K/CRI 90 / 13W - 1460 lm - 3000K/CRI 90

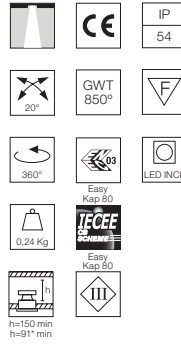
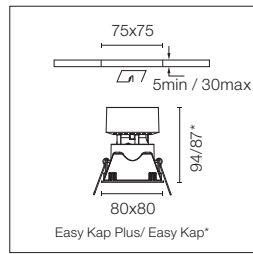

LED Einbauleuchte. Ohne Netzgerät. Installationsrahmen nicht notwendig. Diffusorlinse inbegriffen. Recessed luminaire with LED light source. Power supply not included. Installation frame not necessary. Diffusing lens included.

Empfohlene Netzgeräte / Recommended power supply*:

	Easy Kap 80	Easy Kap 80 Plus
Non Dimmable	60.9160	60.9592
Dimmable 0/1-10V	60.9188	60.9188
Dimmable Dali 1	60.8847	60.8847
Dimmable Dali 2	60.9222	60.9222
Mains Dimming	60.9411	60.9467
Casambi	60.9207	60.9207

* Siehe Treiberkapitel / Refer to the Drivers chapter

- 2700K**
 Easy Kap 80 Square
 03.4294.B1
 Easy Kap 80 Plus Square
 05.7443.B1

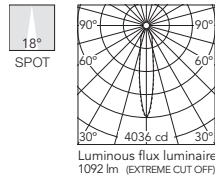

Beam Angle: 18°

h(m)	E(lx)	D(m)
1	4036	0.31
2	1009	0.62
3	448	0.93
4	252	1.24
5	161	1.55

- 3000K**
 Easy Kap 80 Square
 03.4293.B1
 Easy Kap 80 Plus Square
 05.7442.B1

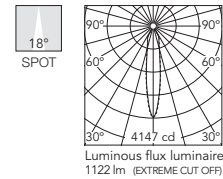

Beam Angle: 18°

h(m)	E(lx)	D(m)
1	4147	0.31
2	1037	0.62
3	461	0.93
4	259	1.24
5	166	1.55

- Easy Kap 80 Square
 03.4294.GL
 Easy Kap 80 Plus Square
 05.7443.GL

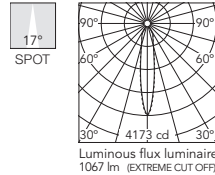

Beam Angle: 17°

h(m)	E(lx)	D(m)
1	4173	0.31
2	1043	0.62
3	464	0.92
4	261	1.23
5	167	1.54

- Easy Kap 80 Square
 03.4293.GL
 Easy Kap 80 Plus Square
 05.7442.GL

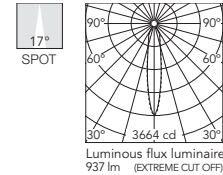

Beam Angle: 17°

h(m)	E(lx)	D(m)
1	3664	0.31
2	916	0.62
3	407	0.92
4	229	1.23
5	147	1.54

- Easy Kap 80 Square
 03.4294.BU
 Easy Kap 80 Plus Square
 05.7443.BU

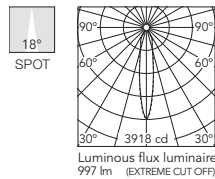

Beam Angle: 18°

h(m)	E(lx)	D(m)
1	3918	0.31
2	979	0.62
3	435	0.93
4	245	1.24
5	157	1.55

- Easy Kap 80 Square
 03.4293.BU
 Easy Kap 80 Plus Square
 05.7442.BU

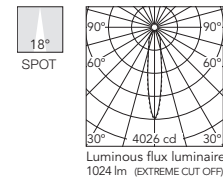

Beam Angle: 18°

h(m)	E(lx)	D(m)
1	4026	0.31
2	1006	0.62
3	447	0.93
4	252	1.24
5	161	1.55

- Easy Kap 80 Square
 03.4294.74
 Easy Kap 80 Plus Square
 05.7443.74

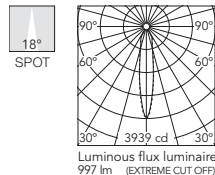

Beam Angle: 18°

h(m)	E(lx)	D(m)
1	3939	0.31
2	985	0.62
3	438	0.93
4	246	1.24
5	158	1.54

- Easy Kap 80 Square
 03.4293.74
 Easy Kap 80 Plus Square
 05.7442.74

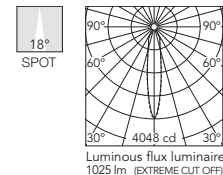

Beam Angle: 18°

h(m)	E(lx)	D(m)
1	4048	0.31
2	1012	0.62
3	450	0.93
4	253	1.24
5	162	1.54

- Easy Kap 80 Square
 03.4294.CU
 Easy Kap 80 Plus Square
 05.7443.CU

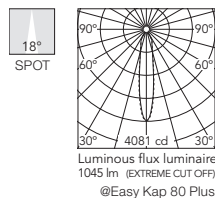

Beam Angle: 18°

h(m)	E(lx)	D(m)
1	4081	0.32
2	1020	0.63
3	453	0.95
4	255	1.26
5	163	1.58

- Easy Kap 80 Square
 03.4293.CU
 Easy Kap 80 Plus Square
 05.7442.CU

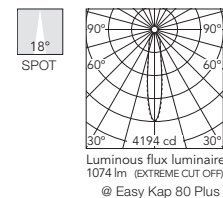

Beam Angle: 18°

h(m)	E(lx)	D(m)
1	4194	0.32
2	1049	0.63
3	466	0.95
4	262	1.26
5	168	1.58

KAP

Easy Kap 80 Square Adjustable - Optic Spot - Dim To Warm

Light Source: LED Array 13W - 1800K - 2850K/CRI 95 - Dim To Warm

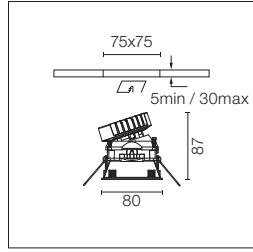

LED Einbauleuchte. 220-240V und dimmbares 1-10V Netzteil inklusive. Für Versionen mit 110-V-Geräten wenden Sie sich an das Frontoffice. Installationsrahmen nicht notwendig. Diffusorlinse inbegriffen.

Recessed luminaire with LED light source. 220-240V & dimmable 1-10V power supply included. For 110V PSU versions, please consult with the front office. Installation frame not necessary. Diffusing lens included.

1800K-2850K
03.4293.B1.LE

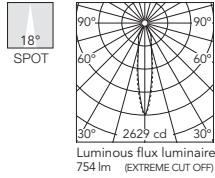

Beam Angle: 18°

h(m)	E(lx)	D(m)
1	2629	0.31
2	657	0.63
3	292	0.94
4	164	1.26
5	105	1.57

03.4293.GL.LE

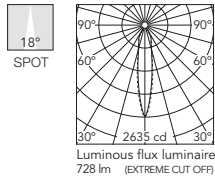

Beam Angle: 18°

h(m)	E(lx)	D(m)
1	2635	0.32
2	659	0.63
3	293	0.95
4	165	1.26
5	105	1.58

03.4293.BU.LE

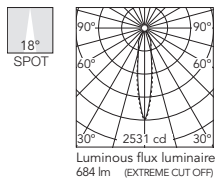

Beam Angle: 18°

h(m)	E(lx)	D(m)
1	2531	0.31
2	633	0.63
3	281	0.94
4	158	1.26
5	101	1.57

03.4293.74.LE

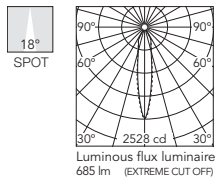

Beam Angle: 18°

h(m)	E(lx)	D(m)
1	2528	0.31
2	632	0.63
3	281	0.94
4	158	1.25
5	101	1.57

03.4293.CU.LE

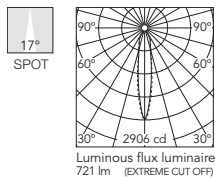

Beam Angle: 17°

h(m)	E(lx)	D(m)
1	2906	0.30
2	726	0.59
3	323	0.89
4	182	1.18
5	116	1.48

KAP

Easy Kap 80 Square/Easy Kap 80 Square Plus - Adjustable - Optic Medium

Light Source: Easy Kap 80 Square: LED Array DC 500 mA - 9,2W - 935 lm - 2700K/CRI 90 / 9,2W - 974 lm - 3000K/CRI 90

Easy Kap 80 Square Plus: LED Array DC 700 mA - 13W - 1370 lm - 2700K/CRI 90 / 13W - 1460 lm - 3000K/CRI 90

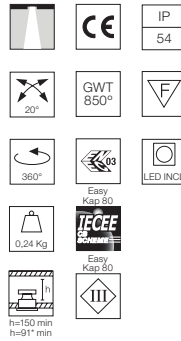
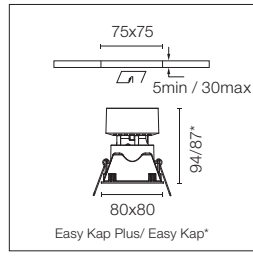

LED Einbauleuchte. Ohne Netzgerät. Installationsrahmen nicht notwendig. Diffusorlinse inbegriffen. Recessed luminaire with LED light source. Power supply not included. Installation frame not necessary. Diffusing lens included.

Empfohlene Netzgeräte / Recommended power supply*:

	Easy Kap 80	Easy Kap 80 Plus
Non Dimmable	60.9160	60.9592
Dimmable 0/1-10V	60.9188	60.9188
Dimmable Dali 1	60.8847	60.8847
Dimmable Dali 2	60.9222	60.9222
Mains Dimming	60.9411	60.9467
Casambi	60.9207	60.9207

* Siehe Treiberkapitel / Refer to the Drivers chapter

2700K

- Easy Kap 80 Square
- 03.4201.B1
- Easy Kap 80 Plus Square
- 05.7439.B1

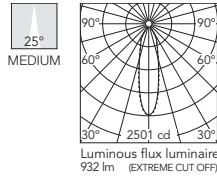

Beam Angle: 25°

h(m)	E(lx)	D(m)
1	2501	0.44
2	625	0.88
3	278	1.32
4	156	1.76
5	100	2.20

3000K

- Easy Kap 80 Square
- 03.4200.B1
- Easy Kap 80 Plus Square
- 05.7438.B1

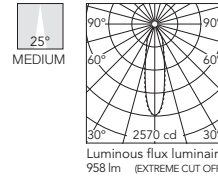

Beam Angle: 25°

h(m)	E(lx)	D(m)
1	2570	0.44
2	643	0.88
3	286	1.32
4	161	1.76
5	103	2.20

- Easy Kap 80 Square
- 03.4201.GL
- Easy Kap 80 Plus Square
- 05.7439.GL

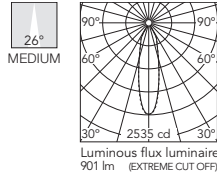

Beam Angle: 26°

h(m)	E(lx)	D(m)
1	2535	0.46
2	634	0.91
3	282	1.37
4	158	1.83
5	101	2.28

- Easy Kap 80 Square
- 03.4200.GL
- Easy Kap 80 Plus Square
- 05.7438.GL

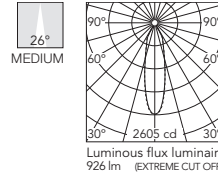

Beam Angle: 26°

h(m)	E(lx)	D(m)
1	2605	0.46
2	651	0.91
3	289	1.37
4	163	1.83
5	104	2.28

- Easy Kap 80 Square
- 03.4201.BU
- Easy Kap 80 Plus Square
- 05.7439.BU

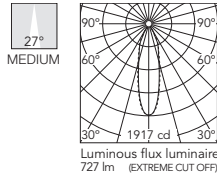

Beam Angle: 27°

h(m)	E(lx)	D(m)
1	1917	0.47
2	479	0.94
3	213	1.41
4	120	1.88
5	77	2.36

- Easy Kap 80 Square
- 03.4200.BU
- Easy Kap 80 Plus Square
- 05.7438.BU

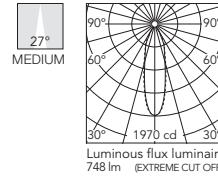

Beam Angle: 27°

h(m)	E(lx)	D(m)
1	1970	0.47
2	492	0.94
3	219	1.41
4	123	1.88
5	79	2.36

- Easy Kap 80 Square
- 03.4201.74
- Easy Kap 80 Plus Square
- 05.7439.74

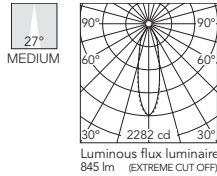

Beam Angle: 27°

h(m)	E(lx)	D(m)
1	2282	0.49
2	570	0.97
3	254	1.46
4	143	1.94
5	91	2.43

- Easy Kap 80 Square
- 03.4200.74
- Easy Kap 80 Plus Square
- 05.7438.74

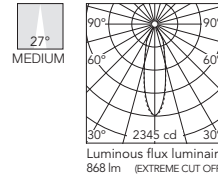

Beam Angle: 27°

h(m)	E(lx)	D(m)
1	2345	0.49
2	586	0.97
3	261	1.46
4	147	1.94
5	94	2.43

- Easy Kap 80 Square
- 03.4201.CU
- Easy Kap 80 Plus Square
- 05.7439.CU

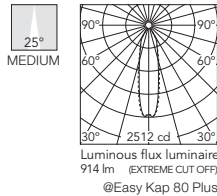

Beam Angle: 25°

h(m)	E(lx)	D(m)
1	2512	0.44
2	628	0.87
3	279	1.31
4	157	1.75
5	100	2.18

- Easy Kap 80 Square
- 03.4200.CU
- Easy Kap 80 Plus Square
- 05.7438.CU

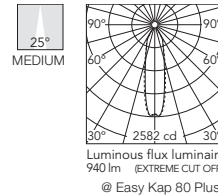

Beam Angle: 25°

h(m)	E(lx)	D(m)
1	2582	0.44
2	645	0.87
3	287	1.31
4	161	1.75
5	103	2.18

KAP

Easy Kap 80 Square Adjustable - Optic Medium - Dim To Warm

Light Source: LED Array 13W - 1800K - 2850K/CRI 95 - Dim To Warm

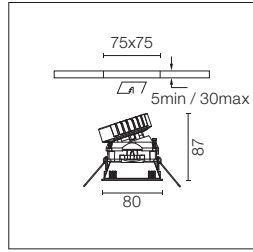

LED Einbauleuchte. 220-240V und dimmbares 1-10V Netzteil inklusive. Für Versionen mit 110-V-Geräten wenden Sie sich an das Frontoffice. Installationsrahmen nicht notwendig. Diffusorlinse inbegriffen.

Recessed luminaire with LED light source. 220-240V & dimmable 1-10V power supply included. For 110V PSU versions, please consult with the front office. Installation frame not necessary. Diffusing lens included.

1800K-2850K
03.4200.B1.LE

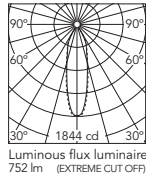

Beam Angle: 26°

h(m)	E(lx)	D(m)
1	1844	0.47
2	461	0.94
3	205	1.41
4	115	1.88
5	74	2.35

03.4200.GL.LE

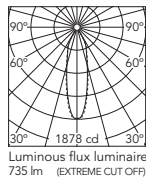

Beam Angle: 27°

h(m)	E(lx)	D(m)
1	1878	0.47
2	470	0.95
3	209	1.42
4	117	1.89
5	75	2.37

03.4200.BU.LE

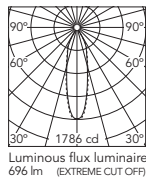

Beam Angle: 27°

h(m)	E(lx)	D(m)
1	1786	0.47
2	447	0.95
3	198	1.42
4	112	1.89
5	71	2.37

03.4200.74.LE

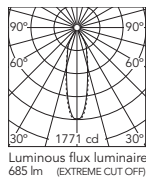

Beam Angle: 27°

h(m)	E(lx)	D(m)
1	1771	0.48
2	443	0.96
3	197	1.44
4	111	1.93
5	71	2.41

03.4200.CU.LE

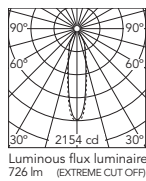

Beam Angle: 22°

h(m)	E(lx)	D(m)
1	2154	0.40
2	538	0.79
3	239	1.19
4	135	1.59
5	86	1.98

KAP

Easy Kap 80 Square/Easy Kap 80 Square Plus - Adjustable - Optic Flood

Light Source: Easy Kap 80 Square: LED Array DC 500 mA - 9,2W - 935 lm - 2700K/CRI 90 / 9,2W - 974 lm - 3000K/CRI 90

Easy Kap 80 Square Plus: LED Array DC 700 mA - 13W - 1370 lm - 2700K/CRI 90 / 13W - 1460 lm - 3000K/CRI 90

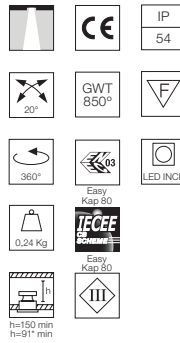
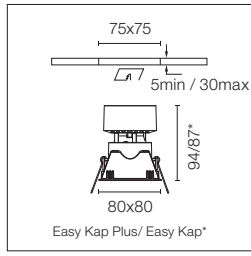

LED Einbauleuchte. Ohne Netzgerät. Installationsrahmen nicht notwendig. Diffusorlinse inbegriffen. Recessed luminaire with LED light source. Power supply not included. Installation frame not necessary. Diffusing lens included.

Empfohlene Netzgeräte / Recommended power supply*:

	Easy Kap 80	Easy Kap 80 Plus
Non Dimmable	60.9160	60.9592
Dimmable 0/1-10V	60.9188	60.9188
Dimmable Dali 1	60.8847	60.8847
Dimmable Dali 2	60.9222	60.9222
Mains Dimming	60.9411	60.9467
Casambi	60.9207	60.9207

* Siehe Treiberkapitel / Refer to the Drivers chapter

- 2700K**
Easy Kap 80 Square
□ 03.4296.B1
Easy Kap 80 Plus Square
□ 05.7445.B1

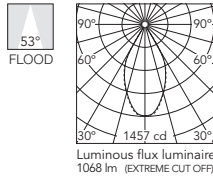

Beam Angle: 53°

h(m)	Et(x)	D(m)
1	1457	0.99
2	364	1.98
3	162	2.98
4	91	3.97
5	58	4.96

- 3000K**
Easy Kap 80 Square
□ 03.4295.B1
Easy Kap 80 Plus Square
□ 05.7444.B1

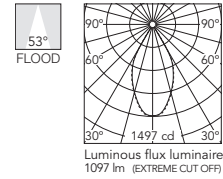

Beam Angle: 53°

h(m)	Et(x)	D(m)
1	1497	0.99
2	374	1.98
3	166	2.98
4	94	3.97
5	60	4.96

- Easy Kap 80 Square
■ 03.4296.GL
Easy Kap 80 Plus Square
■ 05.7445.GL

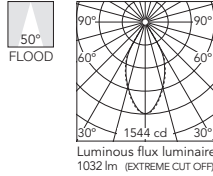

Beam Angle: 50°

h(m)	Et(x)	D(m)
1	1544	0.93
2	386	1.86
3	172	2.79
4	96	3.72
5	62	4.65

- Easy Kap 80 Square
■ 03.4295.GL
Easy Kap 80 Plus Square
■ 05.7444.GL

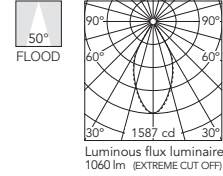

Beam Angle: 50°

h(m)	Et(x)	D(m)
1	1587	0.93
2	397	1.86
3	176	2.79
4	99	3.72
5	63	4.65

- Easy Kap 80 Square
■ 03.4296.BU
Easy Kap 80 Plus Square
■ 05.7445.BU

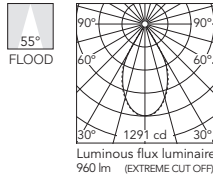

Beam Angle: 55°

h(m)	Et(x)	D(m)
1	1291	1.05
2	323	2.09
3	143	3.14
4	81	4.19
5	52	5.23

- Easy Kap 80 Square
■ 03.4295.BU
Easy Kap 80 Plus Square
■ 05.7444.BU

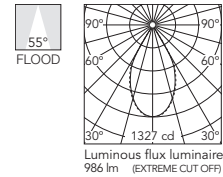

Beam Angle: 55°

h(m)	Et(x)	D(m)
1	1327	1.05
2	332	2.09
3	147	3.14
4	83	4.19
5	53	5.23

- Easy Kap 80 Square
■ 03.4296.74
Easy Kap 80 Plus Square
■ 05.7445.74

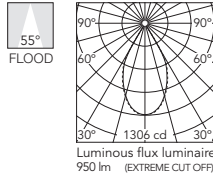

Beam Angle: 55°

h(m)	Et(x)	D(m)
1	1306	1.04
2	326	2.08
3	145	3.11
4	82	4.15
5	52	5.19

- Easy Kap 80 Square
■ 03.4295.74
Easy Kap 80 Plus Square
■ 05.7444.74

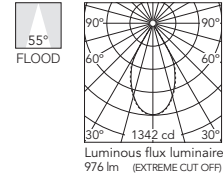

Beam Angle: 55°

h(m)	Et(x)	D(m)
1	1342	1.04
2	335	2.08
3	149	3.11
4	84	4.15
5	54	5.19

- Easy Kap 80 Square
■ 03.4296.CU
Easy Kap 80 Plus Square
■ 05.7445.CU

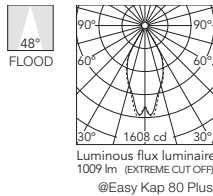

Beam Angle: 48°

h(m)	Et(x)	D(m)
1	1608	0.88
2	402	1.77
3	179	2.65
4	101	3.53
5	64	4.42

- Easy Kap 80 Square
■ 03.4295.CU
Easy Kap 80 Plus Square
■ 05.7444.CU

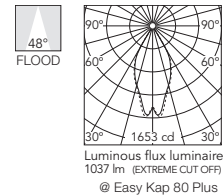

Beam Angle: 48°

h(m)	Et(x)	D(m)
1	1653	0.88
2	413	1.77
3	184	2.65
4	103	3.53
5	66	4.42

Easy Kap 80 Square Adjustable - Optic Flood - Dim To Warm

Light Source: LED Array 13W - 1800K - 2850K/CRI 95 - Dim To Warm

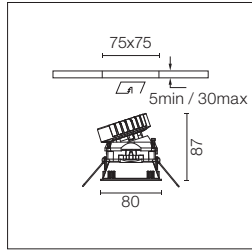

LED Einbauleuchte. 220-240V und dimmbares 1-10V Netzteil inklusive. Für Versionen mit 110-V-Geräten wenden Sie sich an das Frontoffice. Installationsrahmen nicht notwendig. Diffusorlinse inbegriffen.

Recessed luminaire with LED light source. 220-240V & dimmable 1-10V power supply included. For 110V PSU versions, please consult with the front office. Installation frame not necessary. Diffusing lens included.

1800K-2850K
 03.4295.B1.LE

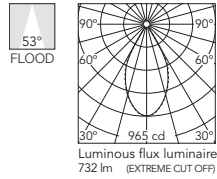

Beam Angle: 53°

h(m)	E(lx)	D(m)
1	965	1.01
2	241	2.01
3	107	3.02
4	60	4.03
5	39	5.03

03.4295.GL.LE

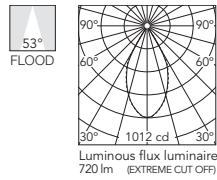

Beam Angle: 53°

h(m)	E(lx)	D(m)
1	1012	0.99
2	253	1.98
3	112	2.97
4	63	3.96
5	40	4.95

03.4295.BU.LE

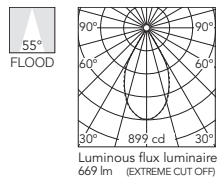

Beam Angle: 55°

h(m)	E(lx)	D(m)
1	899	1.04
2	225	2.08
3	100	3.12
4	56	4.16
5	36	5.21

03.4295.74.LE

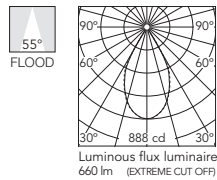

Beam Angle: 55°

h(m)	E(lx)	D(m)
1	888	1.04
2	222	2.07
3	99	3.11
4	55	4.15
5	36	5.18

03.4295.CU.LE

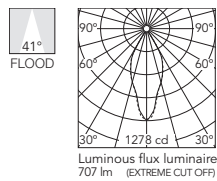

Beam Angle: 41°

h(m)	E(lx)	D(m)
1	1278	0.75
2	319	1.50
3	142	2.25
4	80	3.00
5	51	3.75

KAP

Easy Kap Ø80 Adjustable

Light Source: LED QR-CBC 51 GX5.3

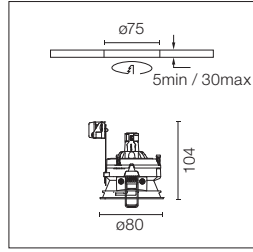

Einbauleuchte für 12V Lampe.
Separater Transformator nicht
inbegriffen. Installationsrahmen
nicht notwendig.
Objektivzubehör nicht erhältlich.

Recessed 12V lamp luminaire.
Remote transformer not included.
Installation frame not necessary.
Not suitable for lens accessories.

- 03.4160.B1
- 03.4160.GL
- 03.4160.BU
- 03.4160.74
- 03.4160.CU

Easy Kap 80 Square Adjustable

Light Source: LED QR-CBC 51 GX5.3

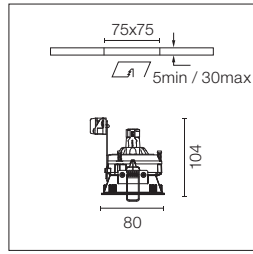

Einbauleuchte für 12V Lampe.
Separater Transformator nicht
inbegriffen. Installationsrahmen
nicht notwendig.
Objektivzubehör nicht erhältlich.

Recessed 12V lamp luminaire.
Remote transformer not included.
Installation frame not necessary.
Not suitable for lens accessories.

- 03.4212.B1
- 03.4212.GL
- 03.4212.BU
- 03.4212.74
- 03.4212.CU

Easy Kap Ø80 Adjustable

Light Source: LED PAR 16 GZ10

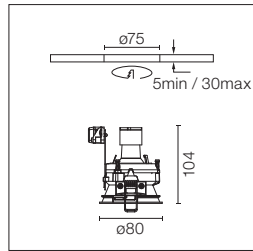

Einbauleuchte für Netzspannung.
Installationsrahmen nicht notwendig.
Objektivzubehör nicht erhältlich.

Recessed luminaire with main
voltage source. Installation frame
not necessary.
Not suitable for lens accessories.

- 03.4162.B1
- 03.4162.GL
- 03.4162.BU
- 03.4162.74
- 03.4162.CU

Easy Kap 80 Square Adjustable

Light Source: LED PAR 16 GZ10

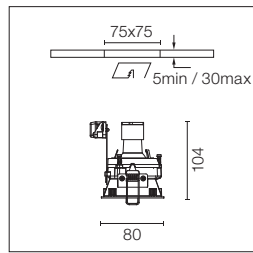

Einbauleuchte für Netzspannung.
Installationsrahmen nicht notwendig.
Objektivzubehör nicht erhältlich.

Recessed luminaire with main
voltage source. Installation frame
not necessary.
Not suitable for lens accessories.

- 03.4213.B1
- 03.4213.GL
- 03.4213.BU
- 03.4213.74
- 03.4213.CU

KAP

Easy Kap Ø80/Easy Kap Ø80 Plus - Wall-Washer

Light Source: Easy Kap Ø80: LED Array DC 500 mA - 9,2W - 935 lm - 2700K/CRI 90 / 9,2W - 974 lm - 3000K/CRI 90
Easy Kap Ø80 Plus: LED Array DC 700 mA - 13W - 1370 lm - 2700K/CRI 90 / 13W - 1460 lm - 3000K/CRI 90

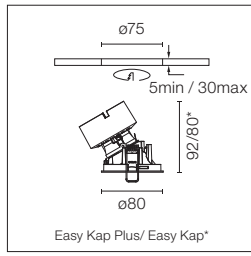

LED Einbauleuchte. Ohne Netzgerät. Installationsrahmen nicht notwendig. Elliptische Linse enthalten.
 Recessed luminaire with LED light source. Power supply not included. Installation frame not necessary. Elliptical lens included.

Empfohlene Netzgeräte / Recommended power supply*:

	Easy Kap Ø80	Easy Kap Ø80 Plus
Non Dimmable	60.9160	60.9592
Dimmable 0/1-10V	60.9188	60.9188
Dimmable Dali 1	60.8847	60.8847
Dimmable Dali 2	60.9222	60.9222
Mains Dimming	60.9411	60.9467
Casambi	60.9207	60.9207

* Siehe Treiberkapitel / Refer to the Drivers chapter

- 2700K**
 Easy Kap Ø80
 03.4197.B1
 Easy Kap Ø80 Plus
 05.7435.B1

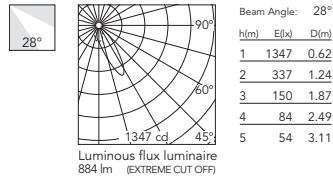

- 3000K**
 Easy Kap Ø80
 03.4196.B1
 Easy Kap Ø80 Plus
 05.7434.B1

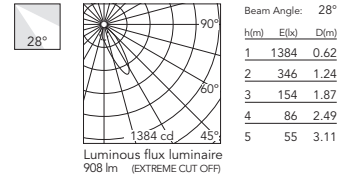

- Easy Kap Ø80
 03.4197.GL
 Easy Kap Ø80 Plus
 05.7435.GL

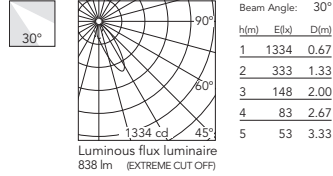

- Easy Kap Ø80
 03.4196.GL
 Easy Kap Ø80 Plus
 05.7434.GL

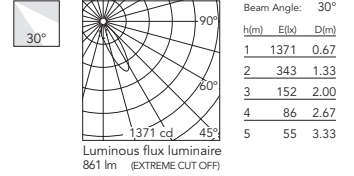

- Easy Kap Ø80
 03.4197.BU
 Easy Kap Ø80 Plus
 05.7435.BU

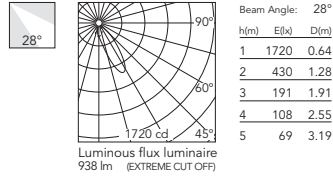

- Easy Kap Ø80
 03.4196.BU
 Easy Kap Ø80 Plus
 05.7434.BU

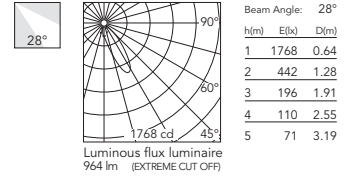

- Easy Kap Ø80
 03.4197.74
 Easy Kap Ø80 Plus
 05.7435.74

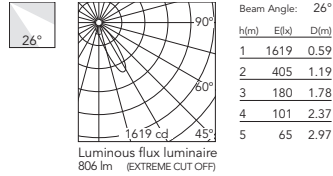

- Easy Kap Ø80
 03.4196.74
 Easy Kap Ø80 Plus
 05.7434.74

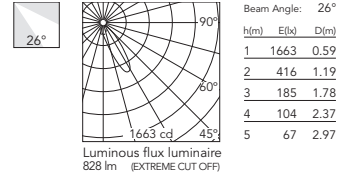

- Easy Kap Ø80
 03.4197.CU
 Easy Kap Ø80 Plus
 05.7435.CU

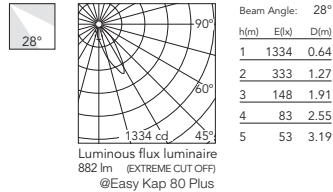

- Easy Kap Ø80
 03.4196.CU
 Easy Kap Ø80 Plus
 05.7434.CU

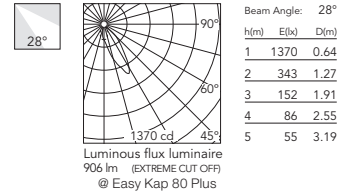

Easy Kap Ø80 Wall-Washer - Dim To Warm

Light Source: LED Array 13W - 1800K - 2850K/CRI 95 - Dim To Warm

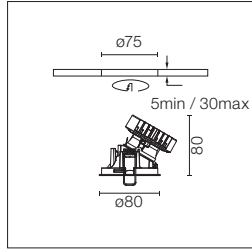

LED Einbauleuchte. 220-240V und dimmbares 1-10V Netzteil inklusive. Für Versionen mit 110-V-Geräten wenden Sie sich an das Frontoffice. Installationsrahmen nicht notwendig. Diffusorlinse inbegriffen.

Recessed luminaire with LED light source. 220-240V & dimmable 1-10V power supply included. For 110V PSU versions, please consult with the front office. Installation frame not necessary. Diffusing lens included.

1800K-2850K
03.4196.B1.LE

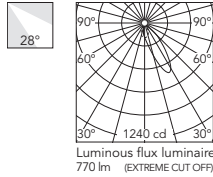

Beam Angle: 28°

h(m)	E(lx)	D(m)
1	1240	0.64
2	310	1.29
3	138	1.93
4	78	2.58
5	50	3.22

03.4196.GL.LE

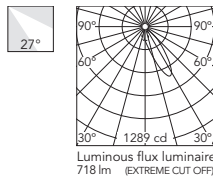

Beam Angle: 27°

h(m)	E(lx)	D(m)
1	1289	0.63
2	322	1.25
3	143	1.88
4	81	2.50
5	52	3.13

03.4196.BU.LE

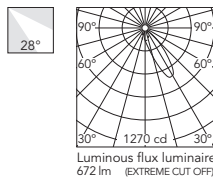

Beam Angle: 28°

h(m)	E(lx)	D(m)
1	1270	0.65
2	317	1.30
3	141	1.96
4	79	2.61
5	51	3.26

03.4196.74.LE

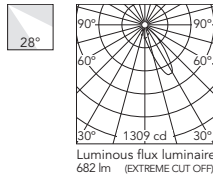

Beam Angle: 28°

h(m)	E(lx)	D(m)
1	1309	0.64
2	327	1.28
3	145	1.92
4	82	2.56
5	52	3.20

03.4196.CU.LE

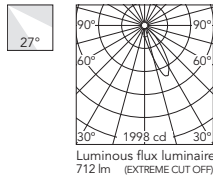

Beam Angle: 27°

h(m)	E(lx)	D(m)
1	1998	0.60
2	500	1.20
3	222	1.80
4	125	2.40
5	80	3.00

KAP

Easy Kap 80 Square/Easy Kap 80 Square Plus - Wall-Washer

Light Source: Easy Kap 80 Square: LED Array DC 500 mA - 9,2W - 935 lm - 2700K/CRI 90 / 9,2W - 974 lm - 3000K/CRI 90

Easy Kap 80 Square Plus: LED Array DC 700 mA - 13W - 1370 lm - 2700K/CRI 90 / 13W - 1460 lm - 3000K/CRI 90

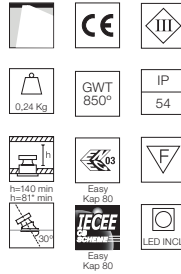
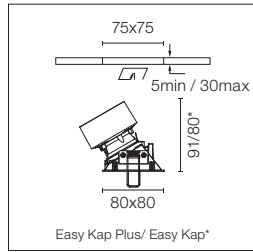

LED Einbauleuchte. Ohne Netzgerät. Installationsrahmen nicht notwendig. Elliptische Linse enthalten.
 Recessed luminaire with LED light source. Power supply not included. Installation frame not necessary. Elliptical lens included.

Empfohlene Netzgeräte / Recommended power supply*:

	Easy Kap 80	Easy Kap 80 Plus
Non Dimmable	60.9160	60.9592
Dimmable 0/1-10V	60.9188	60.9188
Dimmable Dali 1	60.8847	60.8847
Dimmable Dali 2	60.9222	60.9222
Mains Dimming	60.9411	60.9467
Casambi	60.9207	60.9207

* Siehe Treiberkapitel / Refer to the Drivers chapter

- 2700K**
 Easy Kap Ø80
 03.4199.B1
 Easy Kap Ø80 Plus
 05.7437.B1

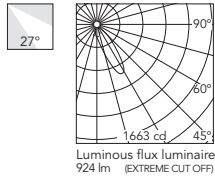

Beam Angle: 27°

h(m)	E(lx)	D(m)
1	1663	0.62
2	416	1.24
3	185	1.85
4	104	2.47
5	67	3.09

- 3000K**
 Easy Kap Ø80
 03.4198.B1
 Easy Kap Ø80 Plus
 05.7436.B1

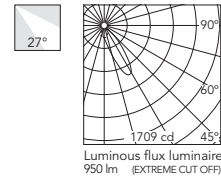

Beam Angle: 27°

h(m)	E(lx)	D(m)
1	1709	0.62
2	427	1.24
3	190	1.85
4	107	2.47
5	68	3.09

- Easy Kap Ø80
 03.4199.GL
 Easy Kap Ø80 Plus
 05.7437.GL

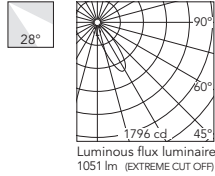

Beam Angle: 28°

h(m)	E(lx)	D(m)
1	1796	0.68
2	449	1.36
3	200	2.04
4	112	2.72
5	72	3.40

- Easy Kap Ø80
 03.4198.GL
 Easy Kap Ø80 Plus
 05.7436.GL

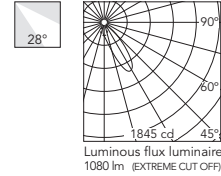

Beam Angle: 28°

h(m)	E(lx)	D(m)
1	1845	0.68
2	461	1.36
3	205	2.04
4	115	2.72
5	74	3.40

- Easy Kap Ø80
 03.4199.BU
 Easy Kap Ø80 Plus
 05.7437.BU

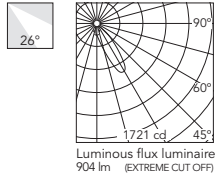

Beam Angle: 26°

h(m)	E(lx)	D(m)
1	1721	0.63
2	430	1.25
3	191	1.88
4	108	2.51
5	69	3.14

- Easy Kap Ø80
 03.4198.BU
 Easy Kap Ø80 Plus
 05.7436.BU

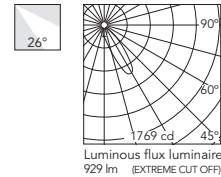

Beam Angle: 26°

h(m)	E(lx)	D(m)
1	1769	0.63
2	442	1.25
3	197	1.88
4	111	2.51
5	71	3.14

- Easy Kap Ø80
 03.4199.74
 Easy Kap Ø80 Plus
 05.7437.74

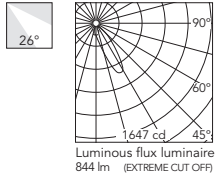

Beam Angle: 26°

h(m)	E(lx)	D(m)
1	1647	0.59
2	412	1.19
3	183	1.78
4	103	2.37
5	66	2.97

- Easy Kap Ø80
 03.4198.74
 Easy Kap Ø80 Plus
 05.7436.74

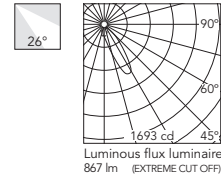

Beam Angle: 26°

h(m)	E(lx)	D(m)
1	1693	0.59
2	423	1.19
3	188	1.78
4	106	2.37
5	68	2.97

- Easy Kap Ø80
 03.4199.CU
 Easy Kap Ø80 Plus
 05.7437.CU

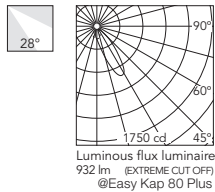

Beam Angle: 28°

h(m)	E(lx)	D(m)
1	1750	0.64
2	437	1.29
3	194	1.93
4	109	2.57
5	70	3.21

- Easy Kap Ø80
 03.4198.CU
 Easy Kap Ø80 Plus
 05.7436.CU

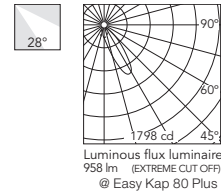

Beam Angle: 28°

h(m)	E(lx)	D(m)
1	1798	0.64
2	450	1.29
3	200	1.93
4	112	2.57
5	72	3.21

Easy Kap 80 Square Wall-Washer - Dim To Warm

Light Source: LED Array 13W - 1800K - 2850K/CRI 95 - Dim To Warm

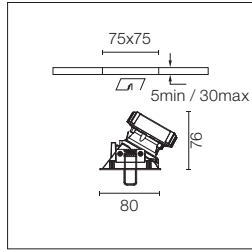

LED Einbauleuchte. 220-240V und dimmbares 1-10V Netzteil inklusive. Für Versionen mit 110-V-Geräten wenden Sie sich an das Frontoffice. Installationsrahmen nicht notwendig. Diffusorlinse inbegriffen.

Recessed luminaire with LED light source. 220-240V & dimmable 1-10V power supply included. For 110V PSU versions, please consult with the front office. Installation frame not necessary. Diffusing lens included.

1800K-2850K
 03.4198.B1.LE

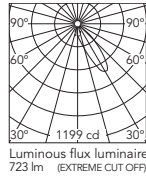

Beam Angle: 28°

h(m)	E(lx)	D(m)
1	1199	0.68
2	300	1.37
3	133	2.05
4	75	2.74
5	48	3.42

03.4198.GL.LE

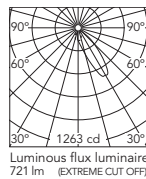

Beam Angle: 28°

h(m)	E(lx)	D(m)
1	1263	0.69
2	316	1.38
3	140	2.07
4	79	2.75
5	51	3.44

03.4198.BU.LE

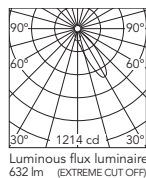

Beam Angle: 28°

h(m)	E(lx)	D(m)
1	1214	0.68
2	304	1.35
3	135	2.03
4	76	2.71
5	49	3.39

03.4198.74.LE

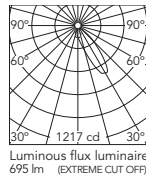

Beam Angle: 27°

h(m)	E(lx)	D(m)
1	1217	0.66
2	304	1.33
3	135	1.99
4	76	2.66
5	49	3.32

03.4198.CU.LE

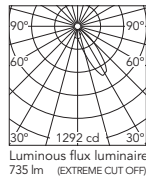

Beam Angle: 29°

h(m)	E(lx)	D(m)
1	1292	0.70
2	323	1.40
3	144	2.10
4	81	2.80
5	52	3.50

KAP

Easy Kap Ø80 Wall-Washer

Light Source: LED QR-CBC 51 GX5.3

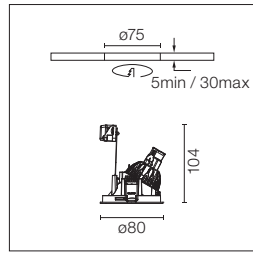

Einbauleuchte für 12V lampe. Separater Transformator nicht inbegriffen. Installationsrahmen nicht notwendig. Objektivzubehör nicht erhältlich.

Recessed 12V lamp luminaire. Remote transformer not included. Installation frame not necessary. Not suitable for lens accessories.

- 03.4220.B1
- 03.4220.GL
- 03.4220.BU
- 03.4220.74
- 03.4220.CU

Easy Kap 80 Square Wall-Washer

Light Source: LED QR-CBC 51 GX5.3

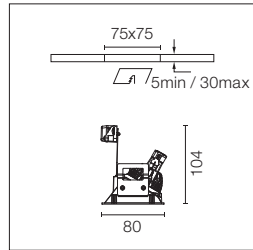

Einbauleuchte für 12V lampe. Separater Transformator nicht inbegriffen. Installationsrahmen nicht notwendig. Objektivzubehör nicht erhältlich.

Recessed 12V lamp luminaire. Remote transformer not included. Installation frame not necessary. Not suitable for lens accessories.

- 03.4218.B1
- 03.4218.GL
- 03.4218.BU
- 03.4218.74
- 03.4218.CU

Easy Kap Ø80 Wall-Washer

Light Source: LED PAR 16 GZ10

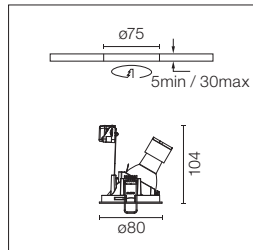

Einbauleuchte für Netzspannung. Installationsrahmen nicht notwendig. Objektivzubehör nicht erhältlich.

Recessed luminaire with main voltage source. Installation frame not necessary. Not suitable for lens accessories.

- 03.4221.B1
- 03.4221.GL
- 03.4221.BU
- 03.4221.74
- 03.4221.CU

Easy Kap 80 Square Wall-Washer

Light Source: LED PAR 16 GZ10

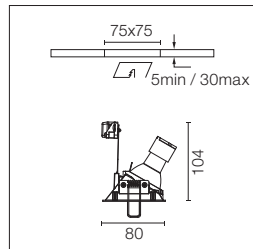

Einbauleuchte für Netzspannung. Installationsrahmen nicht notwendig. Objektivzubehör nicht erhältlich.

Recessed luminaire with main voltage source. Installation frame not necessary. Not suitable for lens accessories.

- 03.4219.B1
- 03.4219.GL
- 03.4219.BU
- 03.4219.74
- 03.4219.CU

KAP

Easy Kap Ø105 Fixed - Optic Spot

Light Source: LED Array DC 650 mA - 23W - 2690 lm - 2700K/CRI 90 / 23W - 2870 lm - 3000K/CRI 90

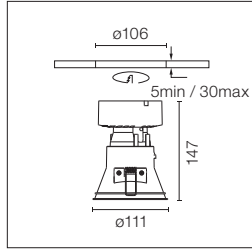

	GWT 850°		LED INCL
	0,55 Kg		III
	IP 54		CE
	h=150 min		△

LED Einbauleuchte. Transformator nicht inbegriffen. Installationsrahmen nicht notwendig.

Recessed luminaire with LED light source. Remote transformer not included. Installation frame not necessary.

Empfohlene Netzgeräte / Recommended power supply*:

Non Dimmable	60.9592
Dimmable 1-10V	60.9439
Dimmable DALI 2	60.9186
Casambi	60.9207

* Siehe Treiberkapitel / Refer to the Drivers chapter

2700K
□ 05.7000.B1

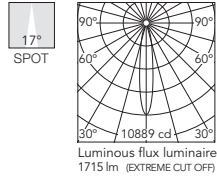

Beam Angle: 17°

h(m)	E(lx)	D(m)
1	10889	0.30
2	2722	0.59
3	1210	0.89
4	681	1.18
5	436	1.48

3000K
□ 05.7005.B1

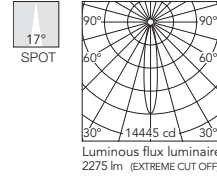

Beam Angle: 17°

h(m)	E(lx)	D(m)
1	14445	0.30
2	3611	0.59
3	1605	0.89
4	903	1.18
5	578	1.48

■ 05.7000.GL

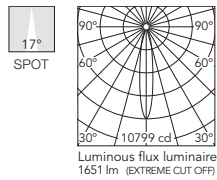

Beam Angle: 17°

h(m)	E(lx)	D(m)
1	10799	0.29
2	2700	0.59
3	1200	0.88
4	675	1.17
5	432	1.47

■ 05.7005.GL

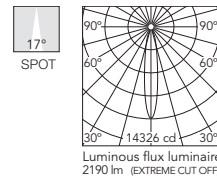

Beam Angle: 17°

h(m)	E(lx)	D(m)
1	14326	0.29
2	3581	0.59
3	1592	0.88
4	895	1.17
5	573	1.47

■ 05.7000.BU

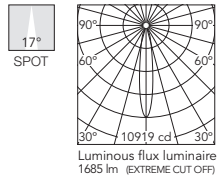

Beam Angle: 17°

h(m)	E(lx)	D(m)
1	10919	0.29
2	2730	0.59
3	1213	0.88
4	682	1.18
5	437	1.47

■ 05.7005.BU

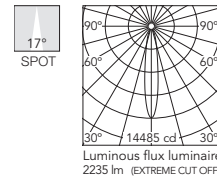

Beam Angle: 17°

h(m)	E(lx)	D(m)
1	14485	0.29
2	3621	0.59
3	1609	0.88
4	905	1.18
5	579	1.47

■ 05.7000.74

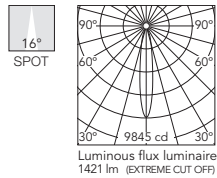

Beam Angle: 16°

h(m)	E(lx)	D(m)
1	9845	0.29
2	2461	0.57
3	1094	0.86
4	615	1.14
5	394	1.43

■ 05.7005.74

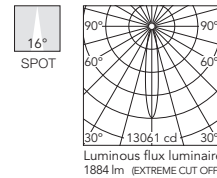

Beam Angle: 16°

h(m)	E(lx)	D(m)
1	13061	0.29
2	3265	0.57
3	1451	0.86
4	816	1.14
5	522	1.43

■ 05.7000.CU

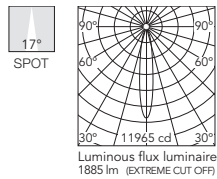

Beam Angle: 17°

h(m)	E(lx)	D(m)
1	11965	0.30
2	2991	0.59
3	1329	0.89
4	748	1.18
5	479	1.48

■ 05.7005.CU

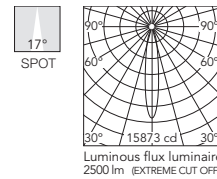

Beam Angle: 17°

h(m)	E(lx)	D(m)
1	15873	0.30
2	3968	0.59
3	1763	0.89
4	993	1.18
5	635	1.48

KAP

Easy Kap Ø105 Fixed - Optic Medium

Light Source: LED Array DC 650 mA - 23W - 2690 lm - 2700K/CRI 90 / 23W - 2870 lm - 3000K/CRI 90

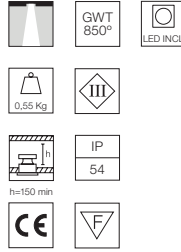
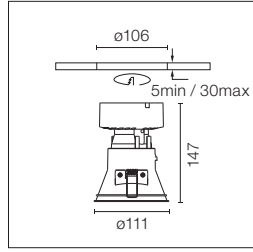

LED Einbauleuchte. Transformator nicht inbegriffen. Installationsrahmen nicht notwendig.

Recessed luminaire with LED light source. Remote transformer not included. Installation frame not necessary.

Empfohlene Netzgeräte / Recommended power supply*:

Non Dimmable	60.9592
Dimmable 1-10V	60.9439
Dimmable DALI 2	60.9186
Casambi	60.9207

* Siehe Treiberkapitel / Refer to the Drivers chapter

2700K
□ 05.7001.B1

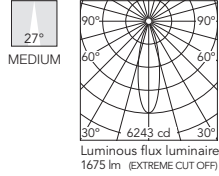

Beam Angle: 27°

h(m)	E(lx)	D(m)
1	6243	0.48
2	1561	0.97
3	694	1.45
4	390	1.93
5	250	2.41

Luminous flux luminaire
1675 lm (EXTREME CUT OFF)

3000K
□ 05.7006.B1

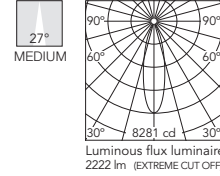

Beam Angle: 27°

h(m)	E(lx)	D(m)
1	8281	0.48
2	2070	0.97
3	920	1.45
4	518	1.93
5	331	2.41

Luminous flux luminaire
2222 lm (EXTREME CUT OFF)

■ 05.7001.GL

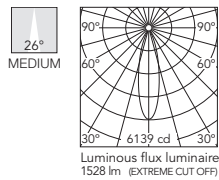

Beam Angle: 26°

h(m)	E(lx)	D(m)
1	6139	0.46
2	1535	0.93
3	682	1.39
4	384	1.86
5	246	2.32

Luminous flux luminaire
1528 lm (EXTREME CUT OFF)

■ 05.7006.GL

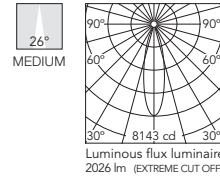

Beam Angle: 26°

h(m)	E(lx)	D(m)
1	8143	0.46
2	2036	0.93
3	905	1.39
4	509	1.86
5	326	2.32

Luminous flux luminaire
2026 lm (EXTREME CUT OFF)

■ 05.7001.BU

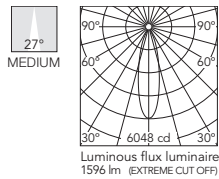

Beam Angle: 27°

h(m)	E(lx)	D(m)
1	6048	0.47
2	1512	0.94
3	672	1.41
4	378	1.89
5	242	2.36

Luminous flux luminaire
1596 lm (EXTREME CUT OFF)

■ 05.7006.BU

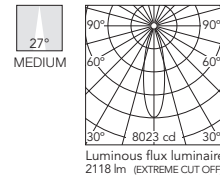

Beam Angle: 27°

h(m)	E(lx)	D(m)
1	8023	0.47
2	2006	0.94
3	891	1.41
4	501	1.89
5	321	2.36

Luminous flux luminaire
2118 lm (EXTREME CUT OFF)

■ 05.7001.74

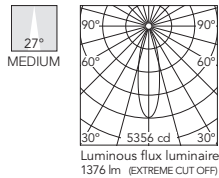

Beam Angle: 27°

h(m)	E(lx)	D(m)
1	5356	0.48
2	1339	0.96
3	595	1.44
4	335	1.92
5	214	2.40

Luminous flux luminaire
1376 lm (EXTREME CUT OFF)

■ 05.7006.74

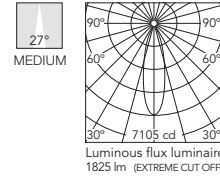

Beam Angle: 27°

h(m)	E(lx)	D(m)
1	7105	0.48
2	1776	0.96
3	789	1.44
4	444	1.92
5	284	2.40

Luminous flux luminaire
1825 lm (EXTREME CUT OFF)

■ 05.7001.CU

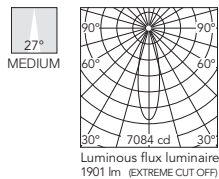

Beam Angle: 27°

h(m)	E(lx)	D(m)
1	7084	0.48
2	1772	0.97
3	787	1.45
4	443	1.93
5	283	2.41

Luminous flux luminaire
1901 lm (EXTREME CUT OFF)

■ 05.7006.CU

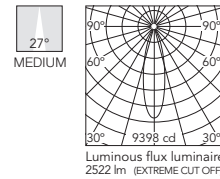

Beam Angle: 27°

h(m)	E(lx)	D(m)
1	9398	0.48
2	2351	0.97
3	1044	1.45
4	588	1.93
5	376	2.41

Luminous flux luminaire
2522 lm (EXTREME CUT OFF)

KAP

Easy Kap Ø105 Fixed - Optic Flood

Light Source: LED Array DC 650 mA - 23W - 2690 lm - 2700K/CRI 90 / 23W - 2870 lm - 3000K/CRI 90

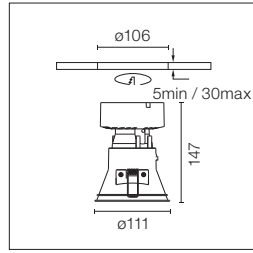

LED Einbauleuchte. Transformator nicht inbegriffen. Installationsrahmen nicht notwendig.

Recessed luminaire with LED light source. Remote transformer not included. Installation frame not necessary.

Empfohlene Netzgeräte / Recommended power supply*:

Non Dimmable	60.9592
Dimmable 1-10V	60.9439
Dimmable Dali 2	60.9186
Casambi	60.9207

* Siehe Treiberkapitel / Refer to the Drivers chapter

2700K
□ 05.7002.B1

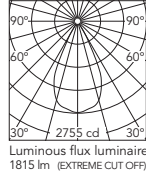

Beam Angle: 51°

h(m)	E(lx)	D(m)
1	2755	0.96
2	689	1.91
3	306	2.87
4	172	3.82
5	110	4.78

3000K
□ 05.7007.B1

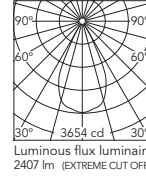

Beam Angle: 51°

h(m)	E(lx)	D(m)
1	3654	0.96
2	914	1.91
3	406	2.87
4	228	3.82
5	146	4.78

■ 05.7002.GL

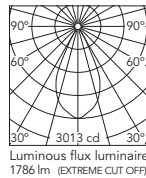

Beam Angle: 50°

h(m)	E(lx)	D(m)
1	3013	0.93
2	753	1.86
3	335	2.79
4	188	3.72
5	121	4.65

■ 05.7007.GL

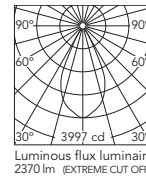

Beam Angle: 50°

h(m)	E(lx)	D(m)
1	3997	0.93
2	999	1.86
3	444	2.79
4	250	3.72
5	160	4.65

■ 05.7002.BU

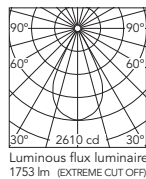

Beam Angle: 53°

h(m)	E(lx)	D(m)
1	2610	1.01
2	652	2.01
3	290	3.02
4	163	4.03
5	104	5.04

■ 05.7007.BU

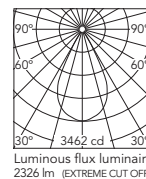

Beam Angle: 53°

h(m)	E(lx)	D(m)
1	3462	1.01
2	866	2.01
3	385	3.02
4	216	4.03
5	138	5.04

■ 05.7002.74

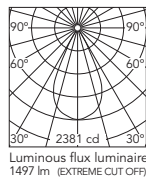

Beam Angle: 51°

h(m)	E(lx)	D(m)
1	2381	0.95
2	595	1.91
3	265	2.86
4	149	3.82
5	95	4.77

■ 05.7007.74

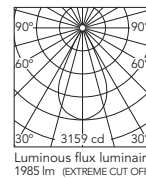

Beam Angle: 51°

h(m)	E(lx)	D(m)
1	3159	0.95
2	790	1.91
3	351	2.86
4	197	3.82
5	126	4.77

■ 05.7002.CU

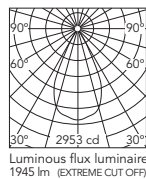

Beam Angle: 51°

h(m)	E(lx)	D(m)
1	2953	0.96
2	739	1.91
3	329	2.87
4	185	3.82
5	119	4.78

■ 05.7007.CU

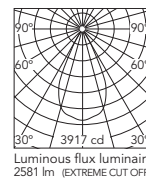

Beam Angle: 51°

h(m)	E(lx)	D(m)
1	3917	0.96
2	981	1.91
3	436	2.87
4	245	3.82
5	157	4.78

Easy Kap Ø105 Fixed EVO

Light Source: LED QR-CBC 51 GX5.3

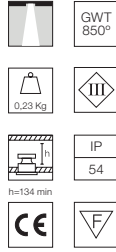
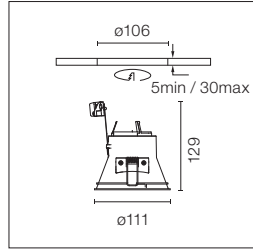

Einbauleuchte für 12V lampe.
Separater Transformator nicht
inbegriffen.
Um die Glühbirne zu ersetzen, muss
die Leuchte entfernt werden.
Installationsrahmen nicht notwendig.
Objektivzubehör nicht erhältlich.

Recessed 12V lamp luminaire.
Remote transformer not included.
To replace the bulb, the luminaire
must be removed.
Installation frame not necessary.
Not suitable for lens accessories.

- 05.7030.B1
- 05.7030.GL
- 05.7030.BU
- 05.7030.74
- 05.7030.CU

Easy Kap Ø105 Fixed EVO

Light Source: LED PAR 16 GZ10

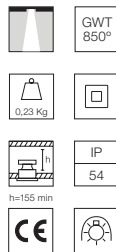
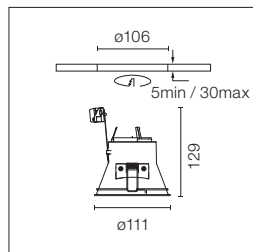

Einbauleuchte für Netzspannung.
Um die Glühbirne zu ersetzen, muss
die Leuchte entfernt werden.
Installationsrahmen nicht notwendig.
Objektivzubehör nicht erhältlich.

Recessed luminaire with main
voltage source.
To replace the bulb, the luminaire
must be removed.
Installation frame not necessary.
Not suitable for lens accessories.

- 05.7031.B1
- 05.7031.GL
- 05.7031.BU
- 05.7031.74
- 05.7031.CU

KAP

Easy Kap Ø105 Adjustable - Optic Spot

Light Source: LED Array DC 650 mA - 23W - 2690 lm - 2700K/CRI 90 / 23W - 2870 lm - 3000K/CRI 90

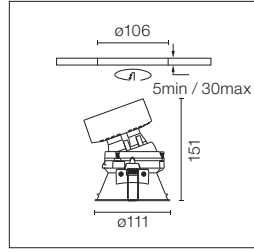

LED Einbauleuchte. Transformator nicht inbegriffen. Installationsrahmen nicht notwendig.

Recessed luminaire with LED light source. Remote transformer not included. Installation frame not necessary.

Empfohlene Netzgeräte / Recommended power supply*:

Non Dimmable	60.9592
Dimmable 1-10V	60.9439
Dimmable Dali 2	60.9186
Casambi	60.9207

* Siehe Treiberkapitel / Refer to the Drivers chapter

2700K
□ 05.7010.B1

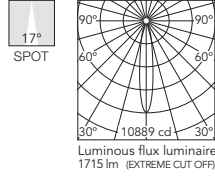

Beam Angle: 17°

h(m)	E(lx)	D(m)
1	10889	0.30
2	2722	0.59
3	1210	0.89
4	681	1.18
5	436	1.48

3000K
□ 05.7015.B1

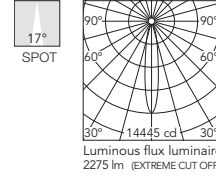

Beam Angle: 17°

h(m)	E(lx)	D(m)
1	14445	0.30
2	3611	0.59
3	1605	0.89
4	903	1.18
5	578	1.48

■ 05.7010.GL

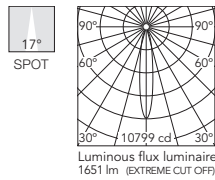

Beam Angle: 17°

h(m)	E(lx)	D(m)
1	10799	0.29
2	2700	0.59
3	1200	0.88
4	675	1.17
5	432	1.47

■ 05.7015.GL

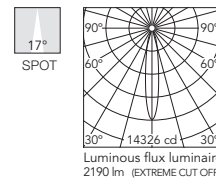

Beam Angle: 17°

h(m)	E(lx)	D(m)
1	14326	0.29
2	3581	0.59
3	1592	0.88
4	895	1.17
5	573	1.47

■ 05.7010.BU

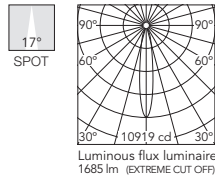

Beam Angle: 17°

h(m)	E(lx)	D(m)
1	10919	0.29
2	2730	0.59
3	1213	0.88
4	682	1.18
5	437	1.47

■ 05.7015.BU

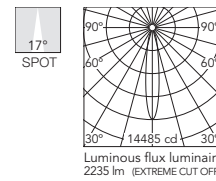

Beam Angle: 17°

h(m)	E(lx)	D(m)
1	14485	0.29
2	3621	0.59
3	1609	0.88
4	905	1.18
5	579	1.47

■ 05.7010.74

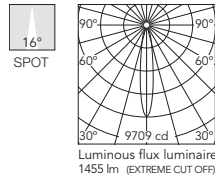

Beam Angle: 16°

h(m)	E(lx)	D(m)
1	9709	0.29
2	2427	0.57
3	1079	0.86
4	607	1.15
5	388	1.43

■ 05.7015.74

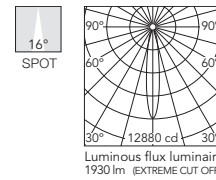

Beam Angle: 16°

h(m)	E(lx)	D(m)
1	12880	0.29
2	3220	0.57
3	1431	0.86
4	805	1.15
5	515	1.43

■ 05.7010.CU

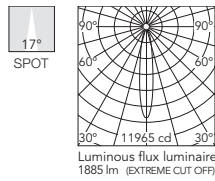

Beam Angle: 17°

h(m)	E(lx)	D(m)
1	11965	0.30
2	2991	0.59
3	1329	0.89
4	748	1.18
5	479	1.48

■ 05.7015.CU

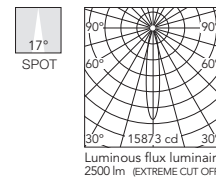

Beam Angle: 17°

h(m)	E(lx)	D(m)
1	15873	0.30
2	3968	0.59
3	1763	0.89
4	993	1.18
5	635	1.48

KAP

Easy Kap Ø105 Adjustable - Optic Medium

Light Source: LED Array DC 650 mA - 23W - 2690 lm - 2700K/CRI 90 / 23W - 2870 lm - 3000K/CRI 90

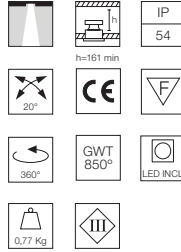
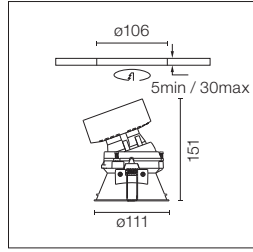

LED Einbauleuchte. Transformator nicht inbegriffen. Installationsrahmen nicht notwendig.

Recessed luminaire with LED light source. Remote transformer not included. Installation frame not necessary.

Empfohlene Netzgeräte / Recommended power supply*:

Non Dimmable	60.9592
Dimmable 1-10V	60.9439
Dimmable DALI 2	60.9186
Casambi	60.9207

* Siehe Treiberkapitel / Refer to the Drivers chapter

2700K
□ 05.7011.B1

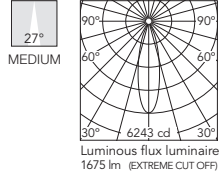

Beam Angle: 27°

h(m)	E(lx)	D(m)
1	6243	0.48
2	1561	0.97
3	694	1.45
4	390	1.93
5	250	2.41

3000K
□ 05.7016.B1

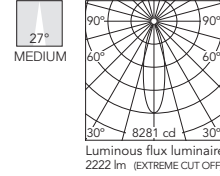

Beam Angle: 27°

h(m)	E(lx)	D(m)
1	8281	0.48
2	2070	0.97
3	920	1.45
4	518	1.93
5	331	2.41

■ 05.7011.GL

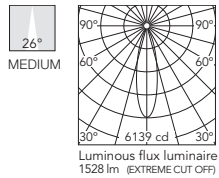

Beam Angle: 26°

h(m)	E(lx)	D(m)
1	6139	0.46
2	1535	0.93
3	682	1.39
4	384	1.86
5	246	2.32

■ 05.7016.GL

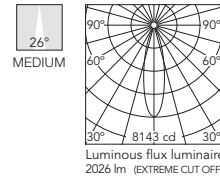

Beam Angle: 26°

h(m)	E(lx)	D(m)
1	8143	0.46
2	2036	0.93
3	905	1.39
4	509	1.86
5	326	2.32

■ 05.7011.BU

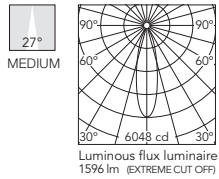

Beam Angle: 27°

h(m)	E(lx)	D(m)
1	6048	0.47
2	1512	0.94
3	672	1.41
4	378	1.89
5	242	2.36

■ 05.7016.BU

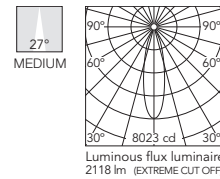

Beam Angle: 27°

h(m)	E(lx)	D(m)
1	8023	0.47
2	2006	0.94
3	891	1.41
4	501	1.89
5	321	2.36

■ 05.7011.74

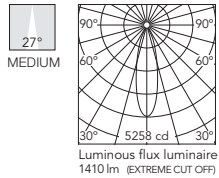

Beam Angle: 27°

h(m)	E(lx)	D(m)
1	5258	0.48
2	1314	0.96
3	584	1.44
4	329	1.92
5	210	2.40

■ 05.7016.74

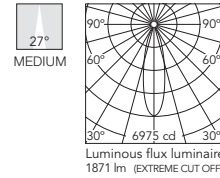

Beam Angle: 27°

h(m)	E(lx)	D(m)
1	6975	0.48
2	1744	0.96
3	775	1.44
4	436	1.92
5	279	2.40

■ 05.7011.CU

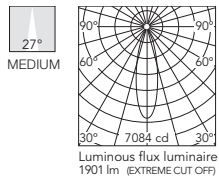

Beam Angle: 27°

h(m)	E(lx)	D(m)
1	7084	0.48
2	1772	0.97
3	787	1.45
4	443	1.93
5	283	2.41

■ 05.7016.CU

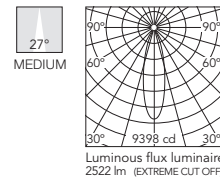

Beam Angle: 27°

h(m)	E(lx)	D(m)
1	9398	0.48
2	2351	0.97
3	1044	1.45
4	588	1.93
5	376	2.41

KAP

Easy Kap Ø105 Adjustable - Optic Flood

Light Source: LED Array DC 650 mA - 23W - 2690 lm - 2700K/CRI 90 / 23W - 2870 lm - 3000K/CRI 90

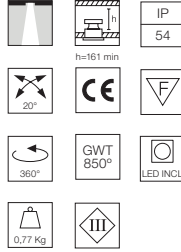
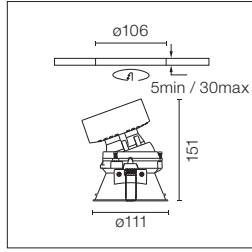

LED Einbauleuchte. Transformator nicht inbegriffen. Installationsrahmen nicht notwendig.

Recessed luminaire with LED light source. Remote transformer not included. Installation frame not necessary.

Empfohlene Netzgeräte / Recommended power supply*:

Non Dimmable	60.9592
Dimmable 1-10V	60.9439
Dimmable DALI 2	60.9186
Casambi	60.9207

* Siehe Treiberkapitel / Refer to the Drivers chapter

2700K
□ 05.7012.B1

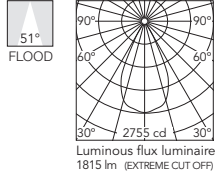

Beam Angle: 51°

h(m)	E(lx)	D(m)
1	2755	0.96
2	689	1.91
3	306	2.87
4	172	3.82
5	110	4.78

3000K
□ 05.7017.B1

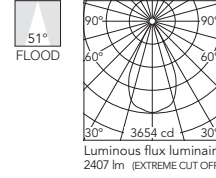

Beam Angle: 51°

h(m)	E(lx)	D(m)
1	3654	0.96
2	914	1.91
3	406	2.87
4	228	3.82
5	146	4.78

■ 05.7012.GL

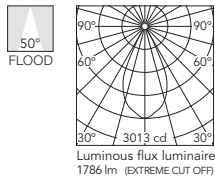

Beam Angle: 50°

h(m)	E(lx)	D(m)
1	3013	0.93
2	753	1.86
3	335	2.79
4	188	3.72
5	121	4.65

■ 05.7017.GL

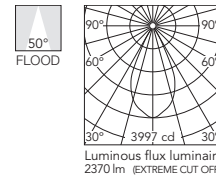

Beam Angle: 50°

h(m)	E(lx)	D(m)
1	3997	0.93
2	999	1.86
3	444	2.79
4	250	3.72
5	160	4.65

■ 05.7012.BU

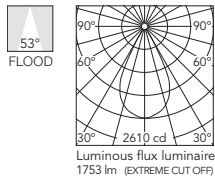

Beam Angle: 53°

h(m)	E(lx)	D(m)
1	2610	1.01
2	652	2.01
3	290	3.02
4	163	4.03
5	104	5.04

■ 05.7017.BU

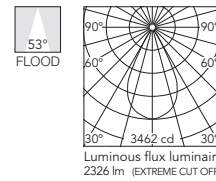

Beam Angle: 53°

h(m)	E(lx)	D(m)
1	3462	1.01
2	866	2.01
3	385	3.02
4	216	4.03
5	138	5.04

■ 05.7012.74

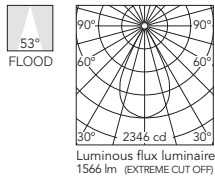

Beam Angle: 53°

h(m)	E(lx)	D(m)
1	2346	1.00
2	587	2.01
3	261	3.01
4	147	4.02
5	94	5.02

■ 05.7017.74

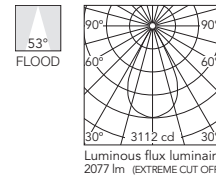

Beam Angle: 53°

h(m)	E(lx)	D(m)
1	3112	1.00
2	778	2.01
3	346	3.01
4	195	4.02
5	124	5.02

■ 05.7012.CU

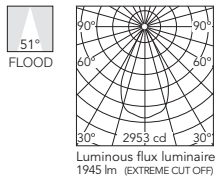

Beam Angle: 51°

h(m)	E(lx)	D(m)
1	2953	0.96
2	739	1.91
3	329	2.87
4	185	3.82
5	119	4.78

■ 05.7017.CU

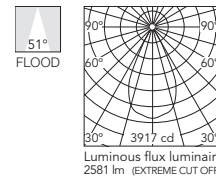

Beam Angle: 51°

h(m)	E(lx)	D(m)
1	3917	0.96
2	981	1.91
3	436	2.87
4	245	3.82
5	157	4.78

KAP

Easy Kap Ø105 Adjustable

Light Source: LED QR-CBC 51 GX5.3

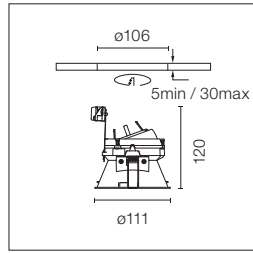

Einbauleuchte für 12V lampe.
Separater Transformator nicht
inbegriffen.
Installationsrahmen nicht notwendig.
Objektivzubehör nicht erhältlich.

Recessed 12V lamp luminaire.
Remote transformer not included.
Installation frame not necessary.
Not suitable for lens accessories.

- 05.7035.B1
- 05.7035.GL
- 05.7035.BU
- 05.7035.74
- 05.7035.CU

Easy Kap Ø105 Adjustable

Light Source: LED PAR 16 GZ10

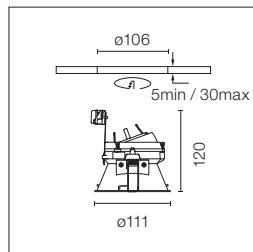

Einbauleuchte für Netzspannung.
Installationsrahmen nicht
notwendig.
Objektivzubehör nicht erhältlich.

Recessed luminaire with main
voltage source.
Installation frame not necessary.
Not suitable for lens accessories.

- 05.7036.B1
- 05.7036.GL
- 05.7036.BU
- 05.7036.74
- 05.7036.CU

KAP

Easy Kap Ø105 Wall-Washer

Light Source: LED Array DC 650 mA - 23W - 2690 lm - 2700K/CRI 90 / 23W - 2870 lm - 3000K/CRI 90

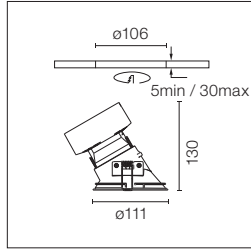

LED Einbauleuchte. Elektronischer Ferntransformator 220/240V nicht inbegriffen. Installationsrahmen nicht notwendig.

Recessed luminaire with LED light source. Remote electronic transformer 220/240V not included. Installation frame not necessary.

Empfohlene Netzgeräte / Recommended power supply*:

Non Dimmable	60.9592
Dimmable 1-10V	60.9439
Dimmable DALI 2	60.9186
Casambi	60.9207

* Siehe Treiberkapitel / Refer to the Drivers chapter

2700K
□ 05.7020.B1

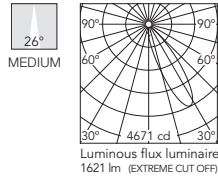

3000K
□ 05.7021.B1

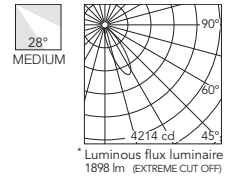

■ 05.7020.GL

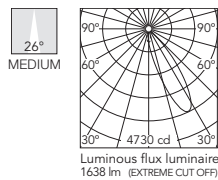

■ 05.7021.GL

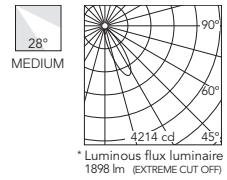

■ 05.7020.BU

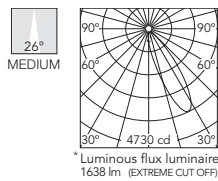

■ 05.7021.BU

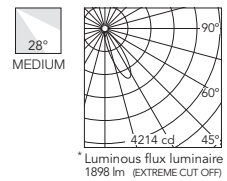

■ 05.7020.74

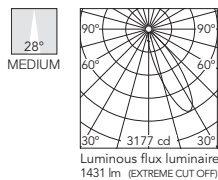

■ 05.7021.74

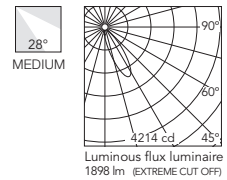

■ 05.7020.CU

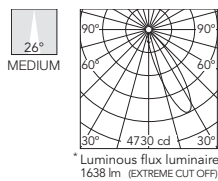

■ 05.7021.CU

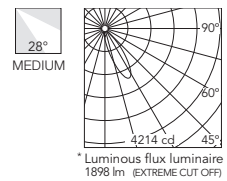

* Vorläufige Photometrien. Aktuelle Informationen finden Sie auf unserer Website / Preliminary photometries. Visit our website for updated information.

KAP

Easy Kap Ø105 Wall-Washer

Light Source: LED QR-CBC 51 GX5.3

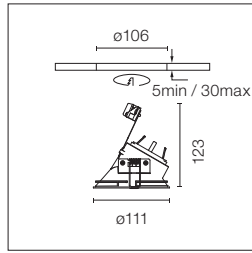

Einbauleuchte für 12V lampe.
Separater Transformator nicht
inbegriffen.
Installationsrahmen nicht notwendig.
Objektivzubehör nicht erhältlich.

Recessed 12V lamp luminaire.
Remote transformer not included.
Installation frame not necessary.
Not suitable for lens accessories.

- 05.7040.B1
- 05.7040.GL
- 05.7040.BU
- 05.7040.74
- 05.7040.CU

Easy Kap Ø105 Wall-Washer

Light Source: LED PAR 16 GZ10

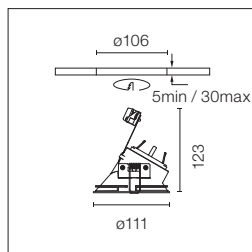









Einbauleuchte für Netzspannung.
Installationsrahmen nicht notwendig.
Objektivzubehör nicht erhältlich.

Recessed luminaire with main
voltage source.
Installation frame not necessary.
Not suitable for lens accessories.

- 05.7041.B1
- 05.7041.GL
- 05.7041.BU
- 05.7041.74
- 05.7041.CU



KAP

Zubehör / Accessories

Vorinstallationsrahmen No Trim. Kap ø50.	Installation frame No Trim. Kap ø50.		<input type="checkbox"/> Kap ø50 Round 08.9114.00
Vorinstallationsrahmen No Trim. Kap ø80/ø80 Plus.	Installation frame No Trim. Kap ø80/ø80 Plus.		<input type="checkbox"/> Kap ø80 Round 08.9102.00
Installationsrahmen No Trim. Kap 80 Square/80 Plus Square.	Installation frame No Trim. Kap 80 Square/80 Plus Square.		<input type="checkbox"/> Kap 80 Square 08.9103.00
Installationsrahmen No Trim. Kap ø105 Deep.	Installation frame No Trim. Kap ø105 Deep.		<input type="checkbox"/> Kap ø105 Deep 08.9104.00
Installationsrahmen No Trim. Kap ø105.	Installation frame No Trim. Kap ø105.		<input type="checkbox"/> Kap ø105 08.0132.00
Vorinstallationsrahmen No Trim. Kap 105 Square.	Installation frame No Trim. Kap 105 Square.		<input type="checkbox"/> Kap 105 Square 08.8479.00
Vorinstallationsrahmen No Trim. Kap ø145/ø145 Wall-Washer.	Installation frame No Trim. Kap ø145/ø145 Wall-Washer.		<input type="checkbox"/> Kap ø145 08.8156.00 <input type="checkbox"/> Kap ø145 W-W 08.8251.00
Vorinstallationsrahmen Trim. Kap ø145/ø145 Wall Washer.	Installation frame Trim. Kap 145/ø145 Wall-Washer.		<input type="checkbox"/> Kap ø145/Kap ø145 W-W 08.8491.30 <input type="checkbox"/> 08.8491.GL <input type="checkbox"/> 08.8491.BU <input type="checkbox"/> 08.8491.14
Installationshülse für Konkret der Ausführung. Kap ø105 Deep/ø145.	Installation can for concrete. Kap ø105 Deep/ø145.		<input type="checkbox"/> Kap ø105 Deep 08.8420.00 <input type="checkbox"/> Kap ø145 08.8421.00

BON JOUR

DESIGNED BY PHILIPPE STARCK

BON JOUR Ø45	BON JOUR Ø90	BON JOUR Ø145
		
LIGHT SOURCE POWER LED 6W 575 lm 2700K/CRI 90 615 lm 3000K/CRI 90	LIGHT SOURCE LED ARRAY 13,5W 1500 lm 2700K/CRI 90 1600 lm 3000K/CRI 90	LIGHT SOURCE LED ARRAY 27W 2600 lm 2700K/CRI 90 2720 lm 3000K/CRI 90

□ 01 Weiss
01 White

■ CU Kupfer
CU Copper

■ 14 Schwarz
14 Black



Produktbeschreibung

LED-Leuchte für Zwischendeckeneinbau.
Nach der Installation ragt die Kante der Leuchte 10 mm aus der Decke heraus und erzeugt dadurch einen einzigartigen, raffinierten optischen Effekt.
Leuchtenkörper aus Spritzgussaluminium. In 3 Größen erhältlich: Ø45 mm, Ø90 mm und Ø145 mm.
Reflektor aus glänzend eloxiertem Aluminium mit Diffusorelement aus Polycarbonat.

Einspeisung

Kabel enthalten, bereit für Anschluss an mitgelieferte Fernsteuerung.
Dimmbare Dali Ausführung erhältlich.
Auf Anfrage Ausführungen ohne Vorschaltgerät und mit 110V-Vorschaltgerät erhältlich.

Zubehör

- Einbaurahmen aus thermoplastischem Material für den Einbau in die Zwischendecke, erforderlich bei den Ausführungen mit Ø90 mm und Ø145 mm (nicht erforderlich bei der Ausführung mit Ø45 mm).
- Honeycomb-Zubehör und Blendschutzgitter (in der Ausführung mit Ø45 mm inkludiert).
- Abschirmelemente erhältlich für die Version mit Ø145, mit den gleichen Eigenschaften wie die dekorative Lichtquelle Bon Jour. Details finden Sie im Flos-Katalog "The Home Collection".

Zusatzinformationen

Schutzgrad IP44.
Schutzklasse II.

Qualitätszeichen

Das Gerät entspricht der europäischen technischen Norm EN60598-1 und den entsprechenden Zusatzregelungen.

Description

LED luminaire for recessed mounting on plasterboard ceilings.
Once installed, the luminaire edge sticks out of the ceiling 10 mm creating a unique and very refined aesthetic effect.
The luminaire's body is injected with aluminium. It is available in three sizes: Ø45 mm, Ø90 mm and Ø145 mm.
Reflector made of anodized gloss aluminium with diffuser element made of polycarbonate.

Power Supply

Cabling included, ready to be powered by included remote driver.
Dali dimmable version available.
Versions without driver and 110V driver available on request.

Accessories

- Installation frame made from thermoplastic material for installation in suspended ceilings required for the Ø90 mm and Ø145 mm versions (not necessary for Ø45 mm version).
- Honeycomb and cross screening cylinder (included for Ø45 mm version).
- Screening accessories available for the Ø145 version, with the same finishes as the decorative Bon Jour luminaire. See the Flos "The Home Collection" catalogue for more information.

Additional Information

IP44 protection grade.
Insulation class II.

Standard Compliance and Quality Marks

EN60598-1 European Technical Standards and any subsequent additions.



Ø45



Ø90 / Ø145

BON JOUR

Bon Jour Ø45

Light Source: Power LED DC 500 mA - 6W - 575 lm - 2700K/CRI 90 / 6W - 615 lm - 3000K/CRI 90

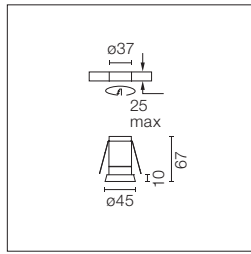

LED Einbauleuchte. Fernnetzgerät mit 220/240V im Lieferumfang enthalten. Notwendiger Zugang zum Treiber durch Registrierung.

Recessed luminaire with LED light source. Remote 220/240V power supply included. It is necessary to anticipate a space for accessing the driver.

Inkludiertes Zubehör (Honeycomb und Blendschutzgitter).

Accessories included (honeycomb and screening crosspiece).

- 3000K**
Non Dimmable
- 03.2006.01
 - Dali Version
 - 03.2006.01.DA

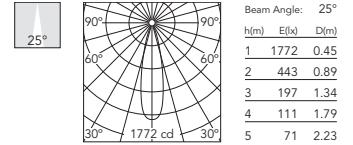

- 2700K**
Non Dimmable
- 03.2001.01
 - Dali Version
 - 03.2001.01.DA

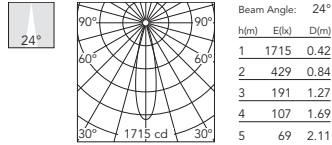

- 2700K**
Non Dimmable
- 03.2001.CU
 - Dali Version
 - 03.2001.CU.DA

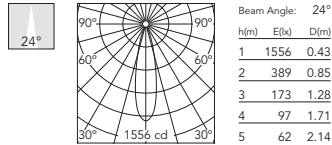

- 3000K**
Non Dimmable
- 03.2006.CU
 - Dali Version
 - 03.2006.CU.DA

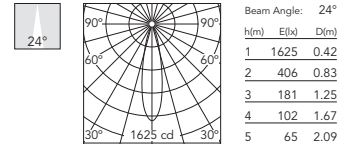

- 2700K**
Non Dimmable
- 03.2001.14
 - Dali Version
 - 03.2001.14.DA

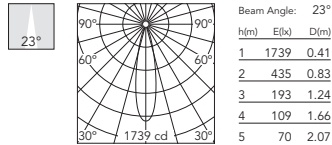

- 3000K**
Non Dimmable
- 03.2006.14
 - Dali Version
 - 03.2006.14.DA

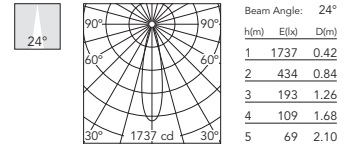

Bon Jour Ø90

Light Source: LED Array DC 500 mA - 13,5W - 1500 lm - 2700K/CRI 90 / 13,5W - 1600 lm - 3000K/CRI 90

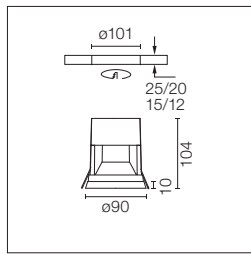

LED Einbauleuchte. Fernnetzgerät mit 220/240V im Lieferumfang enthalten.

Recessed luminaire with LED light source. Remote 220/240V power supply included.

Der Rahmen für das Einbaugehäuse ist getrennt zu bestellen.

Pre-installation frame must be ordered separately.

- 2700K**
Non Dimmable
- 03.2003.01
 - Dali Version
 - 03.2003.01.DA

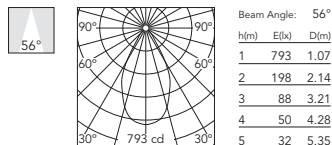

- 3000K**
Non Dimmable
- 03.2007.01
 - Dali Version
 - 03.2007.01.DA

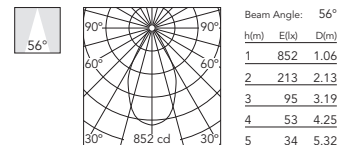

- 2700K**
Non Dimmable
- 03.2003.CU
 - Dali Version
 - 03.2003.CU.DA

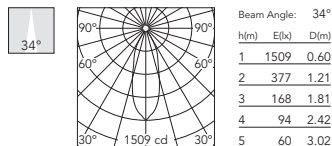

- 3000K**
Non Dimmable
- 03.2007.CU
 - Dali Version
 - 03.2007.CU.DA

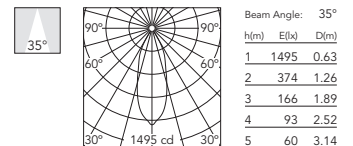

- 2700K**
Non Dimmable
- 03.2003.14
 - Dali Version
 - 03.2003.14.DA

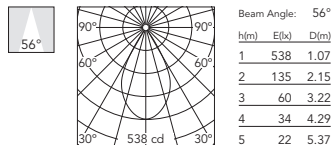

- 3000K**
Non Dimmable
- 03.2007.14
 - Dali Version
 - 03.2007.14.DA

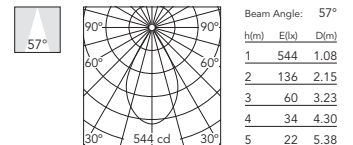

BON JOUR

Bon Jour Ø145

Light Source: LED Array DC 900 mA - 27W - 2600 lm - 2700K/CRI 90 / 27W - 2720 lm - 3000K/CRI 90

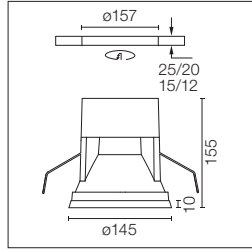

LED Einbauleuchte. Fernnetzgerät mit 220/240V im Lieferumfang enthalten.

Recessed luminaire with LED light source. Remote 220/240V power supply included.

Der Rahmen für das Einbaugehäuse ist getrennt zu bestellen.

Pre-installation frame must be ordered separately.

2700K

Non Dimmable

- 03.2005.01
- Dali Version
- 03.2005.01.DA

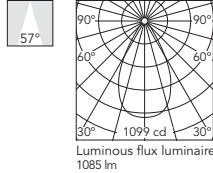

Beam Angle: 57°

h(m)	E(lx)	D(m)
1	1099	1.10
2	275	2.19
3	122	3.29
4	69	4.38
5	44	5.48

Luminous flux luminaire 1085 lm

3000K

Non Dimmable

- 03.2008.01
- Dali Version
- 03.2008.01.DA

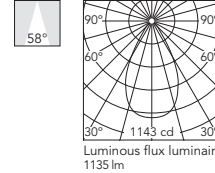

Beam Angle: 58°

h(m)	E(lx)	D(m)
1	1143	1.10
2	286	2.20
3	127	3.31
4	71	4.41
5	46	5.51

Luminous flux luminaire 1135 lm

2700K

Non Dimmable

- 03.2005.CU
- Dali Version
- 03.2005.CU.DA

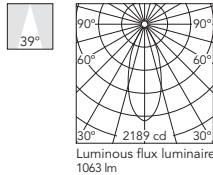

Beam Angle: 39°

h(m)	E(lx)	D(m)
1	2189	0.71
2	547	1.42
3	243	2.13
4	137	2.83
5	88	3.54

Luminous flux luminaire 1063 lm

3000K

Non Dimmable

- 03.2008.CU
- Dali Version
- 03.2008.CU.DA

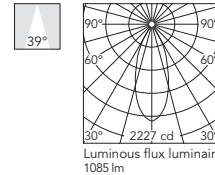

Beam Angle: 39°

h(m)	E(lx)	D(m)
1	2227	0.71
2	557	1.42
3	247	2.13
4	139	2.84
5	89	3.55

Luminous flux luminaire 1085 lm

2700K

Non Dimmable

- 03.2005.14
- Dali Version
- 03.2005.14.DA

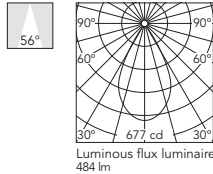

Beam Angle: 56°

h(m)	E(lx)	D(m)
1	677	1.05
2	169	2.11
3	75	3.16
4	42	4.21
5	27	5.27

Luminous flux luminaire 484 lm

3000K

Non Dimmable

- 03.2008.14
- Dali Version
- 03.2008.14.DA

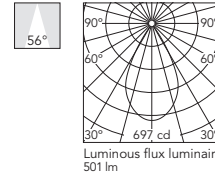

Beam Angle: 56°

h(m)	E(lx)	D(m)
1	697	1.06
2	174	2.11
3	77	3.17
4	44	4.23
5	28	5.28

Luminous flux luminaire 501 lm

BON JOUR

Zubehör / Accessories

Bon Jour Ø90

Kleiner Rahmen. Pre-installation frame.		08.8974.00
--	---	------------

Honeycomb und Querabschirmung. Honeycomb and screening crosspiece.		08.8976.14
---	---	------------

Bon Jour Ø145

Kleiner Rahmen. Pre-installation frame.		08.8975.00
--	---	------------

Honeycomb und Querabschirmung. Honeycomb and screening crosspiece.		08.8980.14
---	---	------------

Dekoratives Abschirmelement als Zubehör. Decorative screening accessory.		08.8977.00
---	---	------------

		08.8978.00
--	---	------------

		08.8979.00
--	---	------------

LIGHT SHOOTER

DESIGNED BY FLOS ARCHITECTURAL

FIXED
TRIM / NO TRIM



ADJUSTABLE
TRIM / NO TRIM



WALL-WASHER
TRIM / NO TRIM



LIGHT SOURCE
POWER LED
10W
850 lm
2700K/CRI 90
910 lm
3000K/CRI 90

LIGHT SOURCE
HIGH
POWER LED
11W
910 lm
2700K/CRI 90
1060 lm
3000K/CRI 90

□ 40 Weiss
40 White

■ 14 Schwarz
14 Black



Drehbar um 360° und schwenkbar 40°.
Can be rotated 360° and swivelled 40°.

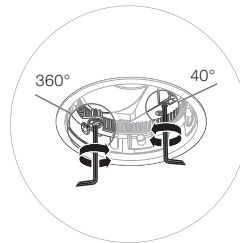
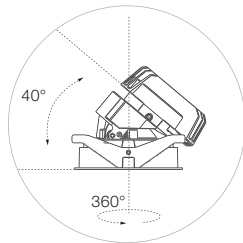

IP54

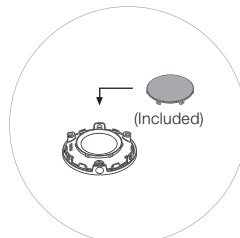

LIGHT SHOOTER

Produktbeschreibung

Einbauleuchten als hochleistungsfähige LED, und dichroitische LED. Leuchte mit einer Kombination aus modernster LED-Technologie und einem hocheffizienten konischen System, das durch sein Design höchste Leistung mit ausgezeichnetem Blendschutz verbinden soll. LED in Leistungsstufen bis 11W erhältlich. Für Trim und No Trim Geräte, feste Ausführung, verstellbare Ausführung und Wandfluter-Ausführung erhältlich.

Die einstellbare Ausführung verfügt über einen integrierten Winkelmesser, der mittels eines einfach handzuhabenden und präzisen Mechanismus bei der Einstellung des gewünschten Strahlwinkels behilflich ist und somit Einbauzeit spart. Durch die Torx-Verriegelung wird der gewünschte Strahlwinkel gesichert.

Die festen und verstellbaren LED-Ausführungen sind jeweils mit engstrahlender und breitstrahlender Optik (Spot bzw. Flood) erhältlich.

Zur Gewährleistung einer perfekten Übereinstimmung innerhalb ein und derselben Anlage ist auch die Wandfluter-Ausführung mit den gleichen LED-Optionen wie die feste und verstellbare Ausführung erhältlich.

Reflektoren

Die festen und verstellbaren LED-Ausführungen sind jeweils mit engstrahlender und breitstrahlender Optik (Spot bzw. Flood) erhältlich.

Einspeisung

Kabel enthalten, bereit für Anschluss an mitgelieferte Fernsteuerung.
Versionen ohne Ansteuerung und 1-10V Dimmausführung auf Wunsch erhältlich.

Zubehör

Die Ausstattung aller Modelle entspricht der Schutzart IP54.

- Elliptische Verteilerlinse.
- Honeycomb.

Zusatzinformationen

Bei den ausrichtbaren Ausführungen: Schwenkwinkel 40° und Drehwinkel 360°.
Schutzgrad IP44.
Schutzklasse II.

Qualitätszeichen

Das Gerät entspricht der europäischen technischen Norm EN60598-1 und den entsprechenden Zusatzregelungen.

Description

High performance LED and LED dichroic recessed luminaires. Combines the latest LED technology and a very efficient conical system designed to combine high performance with excellent glare protection.

Available in wattages up to 11W in LED. Available for Trim and No Trim installations and fixed, adjustable and Wall-Washer versions.

The adjustable version has an integrated goniometer to achieve the desired beam and its easy-to-use precision mechanism makes it easy to handle and quick to install. Its Torx block mechanism ensures the desired beam angle. The fixed and adjustable LED versions are available with enclosed and open optics (spot and flood).

To ensure complete coherency in the same installation, the Wall-Washer version is available with the same LED options as the fixed and adjustable versions.

Reflectors

The fixed and adjustable LED versions are available with enclosed and open optics (spot and flood).

Power Supply

Cabling included, ready to be powered by included remote driver.

Versions without driver and 1-10V dimmable available on request.

Accessories

All the models include an accessory for IP54.

- Elliptical distribution lens.
- Honeycomb.

Additional Information

In the adjustable versions, 40° tilting and 360° rotation.

IP44 protection grade.

Insulation class II.

Standard Compliance and Quality Marks

EN60598-1 European Technical Standards and any subsequent additions.



Trim



No Trim

LIGHT SHOOTER

Light Shooter Fixed Trim

Light Source: Power LED 10W - 850 lm - 2700K/CRI 90 / 10W - 910 lm - 3000K/CRI 90

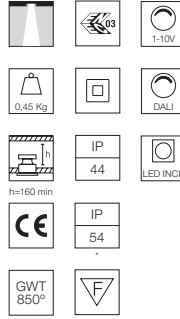
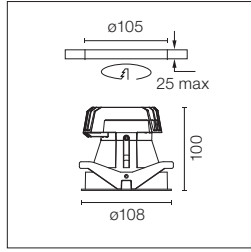

Hochleistungs LED Einbauleuchte. Fernnetzgerät mit 220-240V im Lieferumfang enthalten. * Inklusive Zubehör, um die IP54-Schutzart zu erreichen.

High-performance recessed luminaire with LED light source. Remote 220-240V power supply included. * Accessory to reach IP54 incorporated.

Light Shooter Fixed No Trim

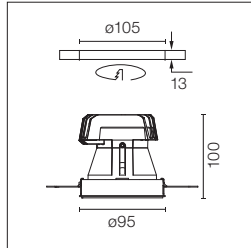

Der Einbaurahmen ist bei der No Trim Version inbegriffen.

Pre-installation frame included in No Trim versions.

2700K - Trim

Non Dimmable

- 03.6509.40A
- 03.6509.14A
- Dali Version/1-10V
- 03.6509.40ADA
- 03.6509.14ADA

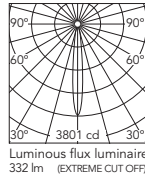

Beam Angle: 12°

h(m)	E(lx)	D(m)
1	3801	0.22
2	950	0.43
3	422	0.65
4	238	0.86
5	152	1.08

Luminous flux luminaire 332 lm (EXTREME CUT OFF)

3000K - Trim

Non Dimmable

- 03.6506.40A
- 03.6506.14A
- Dali Version/1-10V
- 03.6506.40ADA
- 03.6506.14ADA

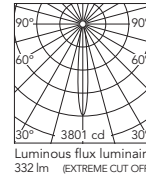

Beam Angle: 12°

h(m)	E(lx)	D(m)
1	3801	0.22
2	950	0.43
3	422	0.65
4	238	0.86
5	152	1.08

Luminous flux luminaire 332 lm (EXTREME CUT OFF)

2700K - No Trim

Non Dimmable

- 03.6529.40A
- 03.6529.14A
- Dali Version/1-10V
- 03.6529.40ADA
- 03.6529.14ADA

3000K - No Trim

Non Dimmable

- 03.6526.40A
- 03.6526.14A
- Dali Version/1-10V
- 03.6526.40ADA
- 03.6526.14ADA

2700K - Trim

Non Dimmable

- 03.6510.40A
- 03.6510.14A
- Dali Version/1-10V
- 03.6510.40ADA
- 03.6510.14ADA

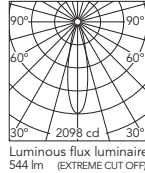

Beam Angle: 25°

h(m)	E(lx)	D(m)
1	2098	0.44
2	524	0.88
3	233	1.33
4	131	1.77
5	84	2.21

Luminous flux luminaire 544 lm (EXTREME CUT OFF)

3000K - Trim

Non Dimmable

- 03.6507.40A
- 03.6507.14A
- Dali Version/1-10V
- 03.6507.40ADA
- 03.6507.14ADA

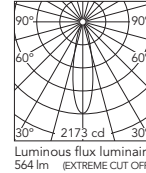

Beam Angle: 25°

h(m)	E(lx)	D(m)
1	2173	0.44
2	543	0.88
3	241	1.33
4	136	1.77
5	87	2.21

Luminous flux luminaire 564 lm (EXTREME CUT OFF)

2700K - No Trim

Non Dimmable

- 03.6530.40A
- 03.6530.14A
- Dali Version/1-10V
- 03.6530.40ADA
- 03.6530.14ADA

3000K - No Trim

Non Dimmable

- 03.6527.40A
- 03.6527.14A
- Dali Version/1-10V
- 03.6527.40ADA
- 03.6527.14ADA

LIGHT SHOOTER

Light Shooter Adjustable Trim

Light Source: Power LED 10W - 850 lm - 2700K/CRI 90 / 10W - 910 lm - 3000K/CRI 90

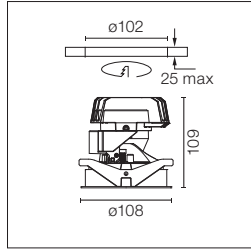

Hochleistungs LED Einbauleuchte. Fernnetzgerät mit 220-240V im Lieferumfang enthalten. * Inklusive Zubehör, um die IP54-Schutzart zu erreichen.

High-performance recessed luminaire with LED light source. Remote 220-240V power supply included. * Accessory to reach IP54 incorporated.

Light Shooter Adjustable No Trim

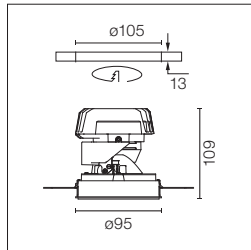

Der Einbaurahmen ist bei der No Trim Version inbegriffen.

Pre-installation frame included in No Trim versions.

2700K - Trim

Non Dimmable

- 03.6503.40A
- 03.6503.14A
- Dali Version/1-10V
- 03.6503.40ADA
- 03.6503.14ADA

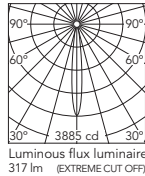

Beam Angle: 13°

h(m)	E(lx)	D(m)
1	3885 0.22	
2	971 0.44	
3	432 0.66	
4	243 0.88	
5	155 1.10	

Luminous flux luminaire 317 lm (EXTREME CUT OFF)

3000K - Trim

Non Dimmable

- 03.6500.40A
- 03.6500.14A
- Dali Version/1-10V
- 03.6500.40ADA
- 03.6500.14ADA

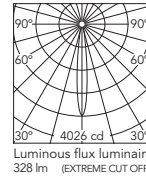

Beam Angle: 13°

h(m)	E(lx)	D(m)
1	4026 0.22	
2	1006 0.44	
3	447 0.66	
4	252 0.88	
5	161 1.10	

Luminous flux luminaire 328 lm (EXTREME CUT OFF)

2700K - No Trim

Non Dimmable

- 03.6523.40A
- 03.6523.14A
- Dali Version/1-10V
- 03.6523.40ADA
- 03.6523.14ADA

3000K - No Trim

Non Dimmable

- 03.6520.40A
- 03.6520.14A
- Dali Version/1-10V
- 03.6520.40ADA
- 03.6520.14ADA

2700K - Trim

Non Dimmable

- 03.6504.40A
- 03.6504.14A
- Dali Version/1-10V
- 03.6504.40ADA
- 03.6504.14ADA

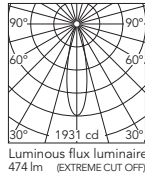

Beam Angle: 25°

h(m)	E(lx)	D(m)
1	1931 0.44	
2	483 0.88	
3	215 1.32	
4	121 1.75	
5	77 2.19	

Luminous flux luminaire 474 lm (EXTREME CUT OFF)

3000K - Trim

Non Dimmable

- 03.6501.40A
- 03.6501.14A
- Dali Version/1-10V
- 03.6501.40ADA
- 03.6501.14ADA

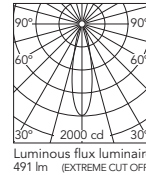

Beam Angle: 25°

h(m)	E(lx)	D(m)
1	2000 0.44	
2	500 0.88	
3	222 1.32	
4	125 1.75	
5	80 2.19	

Luminous flux luminaire 491 lm (EXTREME CUT OFF)

2700K - No Trim

Non Dimmable

- 03.6524.40A
- 03.6524.14A
- Dali Version/1-10V
- 03.6524.40ADA
- 03.6524.14ADA

3000K - No Trim

Non Dimmable

- 03.6521.40A
- 03.6521.14A
- Dali Version/1-10V
- 03.6521.40ADA
- 03.6521.14ADA

LIGHT SHOOTER

Light Shooter Wall-Washer Trim

Light Source: Power LED 10W - 850 lm - 2700K/CRI 90 / 10W - 910 lm - 3000K/CRI 90

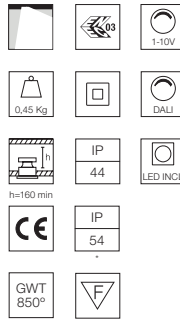
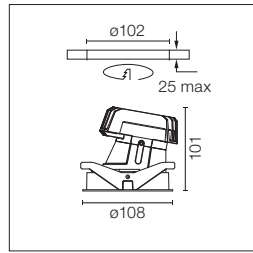

Hochleistungs LED Einbauleuchte. Fernnetzgerät mit 220-240V im Lieferumfang enthalten. * Inklusive Zubehör, um die IP54-Schutzart zu erreichen.

High-performance recessed luminaire with LED light source. Remote 220-240V power supply included. * Accessory to reach IP54 incorporated.

Light Shooter Wall-Washer No Trim

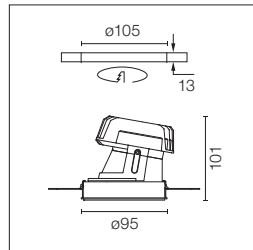

Der Einbaurahmen ist bei der No Trim Version inbegriffen.

Pre-installation frame included in No Trim versions.

2700K - Trim

Non Dimmable

- ☐ 03.6514.40A
- 03.6514.14A
- ☐ Dali Version/1-10V
- ☐ 03.6514.40ADA
- 03.6514.14ADA

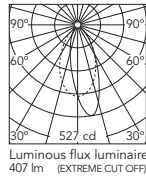

Beam Angle: 34°

h(m)	E(x)	D(m)
1	527	0.62
2	132	1.24
3	59	1.85
4	33	2.47
5	21	3.09

3000K - Trim

Non Dimmable

- ☐ 03.6512.40A
- 03.6512.14A
- ☐ Dali Version/1-10V
- ☐ 03.6512.40ADA
- 03.6512.14ADA

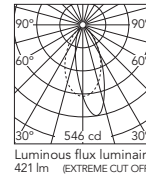

Beam Angle: 34°

h(m)	E(x)	D(m)
1	546	0.62
2	136	1.24
3	61	1.85
4	34	2.47
5	22	3.09

2700K - No Trim

Non Dimmable

- ☐ 03.6534.40A
- 03.6534.14A
- ☐ Dali Version/1-10V
- ☐ 03.6534.40ADA
- 03.6534.14ADA

3000K - No Trim

Non Dimmable

- ☐ 03.6532.40A
- 03.6532.14A
- ☐ Dali Version/1-10V
- ☐ 03.6532.40ADA
- 03.6532.14ADA

LIGHT SHOOTER

Light Shooter HP Fixed Trim

Light Source: High Power LED 11W - 910 lm - 2700K/CRI 90 / 11W - 1060 lm - 3000K/CRI 90

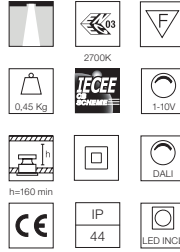
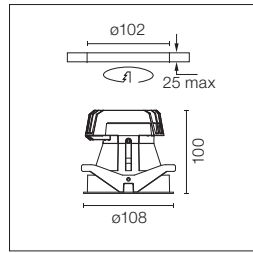

Hochleistungs LED Einbauleuchte. Fernnetzgerät mit 220-240V im Lieferumfang enthalten. * Inklusive Zubehör, um die IP54-Schutzart zu erreichen.

High-performance recessed luminaire with LED light source. Remote 220-240V power supply included. * Accessory to reach IP54 incorporated.

Light Shooter HP Fixed No Trim

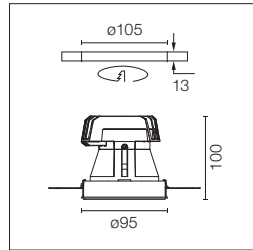

Der Einbaurahmen ist bei der No Trim Version inbegriffen.

Pre-installation frame included in No Trim versions.

2700K - Trim

Non Dimmable

- 03.6566.40
- 03.6566.14
- Dali Version/1-10V
- 03.6566.40.DA
- 03.6566.14.DA

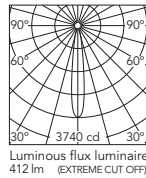

Beam Angle: 15°

h(m)	E(lx)	D(m)
1	3740	0.26
2	935	0.53
3	416	0.79
4	234	1.05
5	150	1.31

Luminous flux luminaire 412 lm (EXTREME CUT OFF)

3000K - Trim

Non Dimmable

- 03.6564.40A
- 03.6564.14A
- Dali Version/1-10V
- 03.6564.40ADA
- 03.6564.14ADA

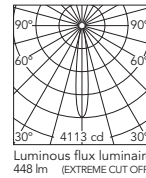

Beam Angle: 15°

h(m)	E(lx)	D(m)
1	4113	0.26
2	1028	0.52
3	457	0.78
4	257	1.04
5	165	1.30

Luminous flux luminaire 448 lm (EXTREME CUT OFF)

2700K - No Trim

Non Dimmable

- 03.6576.40
- 03.6576.14
- Dali Version/1-10V
- 03.6576.40.DA
- 03.6576.14.DA

3000K - No Trim

Non Dimmable

- 03.6574.40A
- 03.6574.14A
- Dali Version/1-10V
- 03.6574.40ADA
- 03.6574.14ADA

2700K - Trim

Non Dimmable

- 03.6567.40
- 03.6567.14
- Dali Version/1-10V
- 03.6567.40.DA
- 03.6567.14.DA

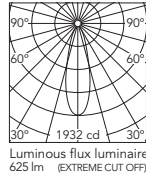

Beam Angle: 29°

h(m)	E(lx)	D(m)
1	1932	0.52
2	483	1.04
3	215	1.56
4	121	2.08
5	77	2.60

Luminous flux luminaire 625 lm (EXTREME CUT OFF)

3000K - Trim

Non Dimmable

- 03.6565.40A
- 03.6565.14A
- Dali Version/1-10V
- 03.6565.40ADA
- 03.6565.14ADA

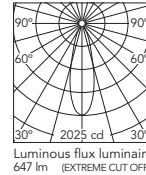

Beam Angle: 29°

h(m)	E(lx)	D(m)
1	2025	0.52
2	506	1.04
3	225	1.56
4	127	2.08
5	81	2.60

Luminous flux luminaire 647 lm (EXTREME CUT OFF)

2700K - No Trim

Non Dimmable

- 03.6577.40
- 03.6577.14
- Dali Version/1-10V
- 03.6577.40.DA
- 03.6577.14.DA

3000K - No Trim

Non Dimmable

- 03.6575.40A
- 03.6575.14A
- Dali Version/1-10V
- 03.6575.40ADA
- 03.6575.14ADA

LIGHT SHOOTER

Light Shooter HP Adjustable Trim

Light Source: High Power LED 11W - 910 lm - 2700K/CRI 90 / 11W - 1060 lm - 3000K/CRI 90

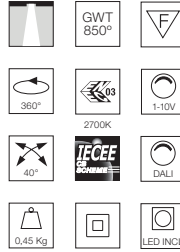
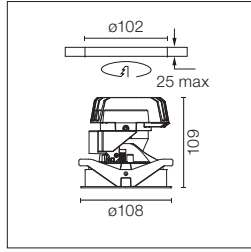

Hochleistungs LED Einbauleuchte. Fernnetzgerät mit 220-240V im Lieferumfang enthalten. * Inklusive Zubehör, um die IP54-Schutzart zu erreichen.

High-performance recessed luminaire with LED light source. Remote 220-240V power supply included. * Accessory to reach IP54 incorporated.

Light Shooter HP Adjustable No Trim

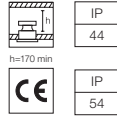
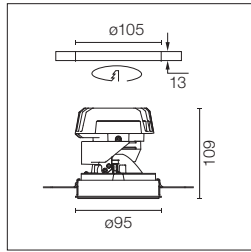

Der Einbaurahmen ist bei der No Trim Version inbegriffen.

Pre-installation frame included in No Trim versions.

2700K - Trim

Non Dimmable

- 03.6562.40
- 03.6562.14
- Dali Version/1-10V
- 03.6562.40.DA
- 03.6562.14.DA

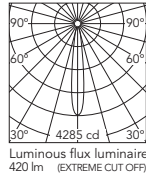

Beam Angle: 14°

h(m)	E(lx)	D(m)
1	4285	0.25
2	1071	0.51
3	476	0.76
4	268	1.02
5	171	1.27

Luminous flux luminaire 420 lm (EXTREME CUT OFF)

3000K - Trim

Non Dimmable

- 03.6560.40A
- 03.6560.14A
- Dali Version/1-10V
- 03.6560.40ADA
- 03.6560.14ADA

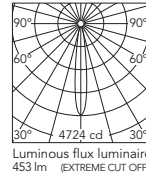

Beam Angle: 14°

h(m)	E(lx)	D(m)
1	4724	0.25
2	1181	0.50
3	525	0.75
4	295	0.99
5	189	1.24

Luminous flux luminaire 453 lm (EXTREME CUT OFF)

2700K - No Trim

Non Dimmable

- 03.6572.40
- 03.6572.14
- Dali Version/1-10V
- 03.6572.40.DA
- 03.6572.14.DA

3000K - No Trim

Non Dimmable

- 03.6570.40A
- 03.6570.14A
- Dali Version/1-10V
- 03.6570.40ADA
- 03.6570.14ADA

2700K - Trim

Non Dimmable

- 03.6563.40
- 03.6563.14
- Dali Version/1-10V
- 03.6563.40.DA
- 03.6563.14.DA

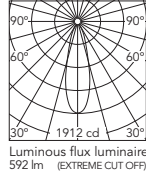

Beam Angle: 29°

h(m)	E(lx)	D(m)
1	1912	0.51
2	478	1.03
3	212	1.54
4	119	2.05
5	76	2.56

Luminous flux luminaire 592 lm (EXTREME CUT OFF)

3000K - Trim

Non Dimmable

- 03.6561.40A
- 03.6561.14A
- Dali Version/1-10V
- 03.6561.40ADA
- 03.6561.14ADA

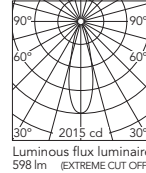

Beam Angle: 28°

h(m)	E(lx)	D(m)
1	2015	0.50
2	504	1.01
3	224	1.51
4	126	2.02
5	81	2.52

Luminous flux luminaire 598 lm (EXTREME CUT OFF)

2700K - No Trim

Non Dimmable

- 03.6573.40
- 03.6573.14
- Dali Version/1-10V
- 03.6573.40.DA
- 03.6573.14.DA

3000K - No Trim

Non Dimmable

- 03.6571.40A
- 03.6571.14A
- Dali Version/1-10V
- 03.6571.40ADA
- 03.6571.14ADA

LIGHT SHOOTER

Light Shooter HP Wall-Washer Trim

Light Source: High Power LED 11W - 910 lm - 2700K/CRI 90 / 11W - 1060 lm - 3000K/CRI 90

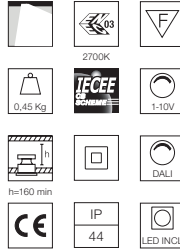
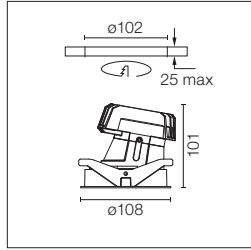

Hochleistungs LED Einbauleuchte. Fernnetzgerät mit 220-240V im Lieferumfang enthalten. * Inklusive Zubehör, um die IP54-Schutzart zu erreichen.

High-performance recessed luminaire with LED light source. Remote 220-240V power supply included. * Accessory to reach IP54 incorporated.

Light Shooter HP Wall-Washer No Trim

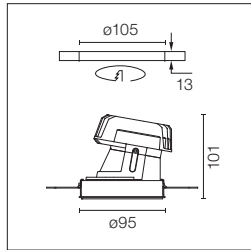

Der Einbaurahmen ist bei der No Trim Version inbegriffen.

Pre-installation frame included in No Trim versions.

2700K - Trim

Non Dimmable

- 03.6569.40
- 03.6569.14
- Dali Version/1-10V
- 03.6569.40.DA
- 03.6569.14.DA

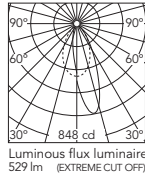

Beam Angle: 26°

h(m)	E lx	D(m)
1	848	0.49
2	212	0.98
3	94	1.47
4	53	1.96
5	34	2.45

Luminous flux luminaire 848 lm (EXTREME CUT OFF)

3000K - Trim

Non Dimmable

- 03.6568.40A
- 03.6568.14A
- Dali Version/1-10V
- 03.6568.40ADA
- 03.6568.14ADA

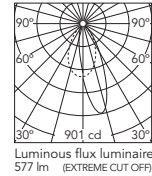

Beam Angle: 27°

h(m)	E lx	D(m)
1	901	0.51
2	225	1.02
3	100	1.53
4	56	2.04
5	36	2.55

Luminous flux luminaire 901 lm (EXTREME CUT OFF)

2700K - No Trim

Non Dimmable

- 03.6579.40
- 03.6579.14
- Dali Version/1-10V
- 03.6579.40.DA
- 03.6579.14.DA

3000K - No Trim

Non Dimmable

- 03.6578.40A
- 03.6578.14A
- Dali Version/1-10V
- 03.6578.40ADA
- 03.6578.14ADA

Zubehör / Accessories

Elliptische linse.

Elliptical lens.



08.8041.68

Honeycomb.

Honeycomb.



08.8412.14

LIGHT SNIPER

DESIGNED BY FLOS ARCHITECTURAL

FIXED ADJUSTABLE WALL-
WASHER



LIGHT SOURCE
POWER LED
11W
910 lm
2700K/CRI 90
1060 lm
3000K/CRI 90

06 Chrom
06 Chrome

GL Mattgold
GL Matt Gold

14 Mattschwarz
14 Matt Black

Light Sniper
Round / Square



Drehbar um 360° und schwenkbar 35°.
Can be rotated 360° and swivelled 35°.

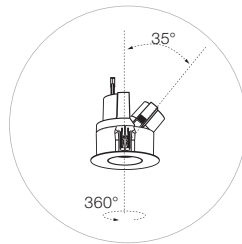

LIGHT SNIPER

Produktbeschreibung

Einbauleuchten mit hohem Leistungsgrad für Lampen LED. Hohem Komfort dank der zurückgesetzten Positionierung des sichtbaren Lichtes. Leuchtenkörper bestehend aus zwei Elementen aus Aluminiumdruckguss. Runder oder viereckiger Vorderrahmen aus Stahlblech mit 1 mm Stärke in der Farbe Mattweiß (RAL 9001). Kegelförmiger Schirm aus Zamak mit Einspritzverfahren realisiert und in drei Farben verfügbar: Schwarz, Mattgold und Chrom. Feste, schwenkbare und Wall-washer-Ausführungen. Bei den Wall-washer-Ausführungen ist die Diffusionslinse aus Borosilicat.

Einspeisung

Vorverkabelung inbegriffen, mit Fernvorrichtungen einsatzbereit. Netzteil eingeschlossen 220-240V.

Zubehör

- Deckenschutzzubehör. Bei dem Einsatz an schwachen Decken.
- Flush-Zubehör. Es ermöglicht den Einsatz an der Wand- oder Deckenkante.
- CAN-Zubehör. Es vereinfacht den Einsatz an Betondecken. Das Zubehör muss zur Verfügung stehen, bevor die Betondecke gebaut wird.
- Honeycomb.
- Farbfilter.

Zusatzinformationen

Bei den ausrichtbaren Ausführungen: Schwenkwinkel 40° und Drehwinkel 360°. Schutzgrad IP23, IP44 je nach Modell. Schutzklasse I, II, III je nach Modell. Auf normal entflammaren Oberflächen einsetzbar.

Qualitätszeichen

Das Gerät entspricht der europäischen technischen Norm EN60598-1 und den entsprechenden Zusatzregelungen.

Description

High performance recessed luminaires for LED version. They offer a high comfort due to the back visual position of light source. Body of the luminaire made of two bodies of injected aluminium. Round or square front ring made of steel sheet 1 mm thick with white matt finish (RAL 9001). It incorporates shielded cones made in zamak injection in three sets: black, matt gold and chrome. Fixed, tilt and wall-washers versions. In wall-washer versions a distribution lens made of borosilicate is incorporated.

Power Supply

Cabling included, ready to be powered by remote devices. Remote 220-240V power supply included.

Accessories

- Accessory for ceiling protection. Recommended for delicate ceiling installation.
- Accessory flush. Allows flush installation to ceiling or wall.
- CAN accessory for installation in concrete. Facilitates installation on concrete ceilings. It is necessary to install fixture prior to the concrete ceiling.
- Honeycomb.
- Chromatic filters.

Additional Information

In the adjustable versions, the possibility of tilting of 40° and 360° rotation. IP23, IP44 protection grade depending on the versions. Insulation class I, II, III depending on the versions. Suitable for installation on normally inflammable surfaces.

Standard Compliance and Quality Marks

EN60598-1 European Technical Standards and any subsequent additions.



Fixed



Adjustable

LIGHT SNIPER

Light Sniper Fixed Round

Light Source: Power LED 11W - 910 lm - 2700K/CRI 90 / 11W - 1060 lm - 3000K/CRI 90

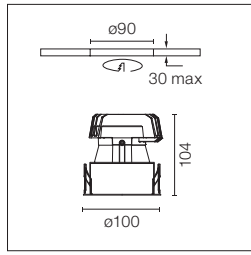

	GWT 850°		IP 44
	0,49 Kg		03
	F		DALI
	h=165 min		03.4981
	CE		LED INCL

Hochleistungs LED Einbauleuchte.
Fernnetzgerät mit 220-240V im
Lieferumfang enthalten.

High-performance recessed
luminaire with LED light source.
Remote 220-240V power supply
included.

2700K

- Non Dimmable
- 03.4981.06
 - 03.4981.GL
 - 03.4981.14
- Dali Version / 1-10V / Push
- 03.4981.06.DA
 - 03.4981.GL.DA
 - 03.4981.14.DA

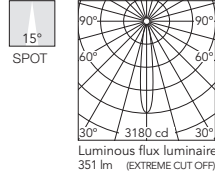

3000K

- Non Dimmable
- 03.4980.06A
 - 03.4980.GLA
 - 03.4980.14A
- Dali Version / 1-10V / Push
- 03.4980.06ADA
 - 03.4980.GLADA
 - 03.4980.14ADA

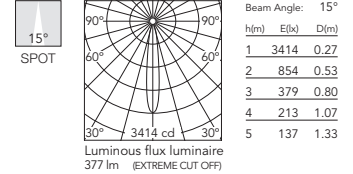

2700K

- Non Dimmable
- 03.4993.06
 - 03.4993.GL
 - 03.4993.14
- Dali Version / 1-10V / Push
- 03.4993.06.DA
 - 03.4993.GL.DA
 - 03.4993.14.DA

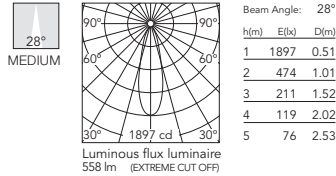

3000K

- Non Dimmable
- 03.4992.06A
 - 03.4992.GLA
 - 03.4992.14A
- Dali Version / 1-10V / Push
- 03.4992.06ADA
 - 03.4992.GLADA
 - 03.4992.14ADA

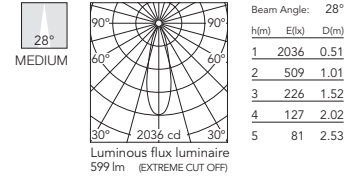

Light Sniper Fixed Square

Light Source: Power LED 11W - 910 lm - 2700K/CRI 90 / 11W - 1060 lm - 3000K/CRI 90

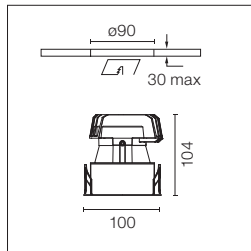

	GWT 850°		IP 44
	0,49 Kg		03
	F		DALI
	h=165 min		03.4983
	CE		LED INCL

Hochleistungs LED Einbauleuchte.
Fernnetzgerät mit 220-240V im
Lieferumfang enthalten.

High-performance recessed
luminaire with LED light source.
Remote 220-240V power supply
included.

2700K

- Non Dimmable
- 03.4983.06
 - 03.4983.GL
 - 03.4983.14
- Dali Version / 1-10V / Push
- 03.4983.06.DA
 - 03.4983.GL.DA
 - 03.4983.14.DA

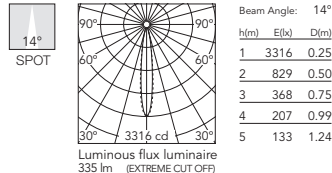

3000K

- Non Dimmable
- 03.4982.06A
 - 03.4982.GLA
 - 03.4982.14A
- Dali Version / 1-10V / Push
- 03.4982.06ADA
 - 03.4982.GLADA
 - 03.4982.14ADA

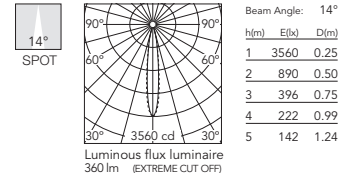

2700K

- Non Dimmable
- 03.4995.06
 - 03.4995.GL
 - 03.4995.14
- Dali Version / 1-10V / Push
- 03.4995.06.DA
 - 03.4995.GL.DA
 - 03.4995.14.DA

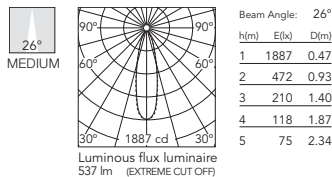

3000K

- Non Dimmable
- 03.4994.06A
 - 03.4994.GLA
 - 03.4994.14A
- Dali Version / 1-10V / Push
- 03.4994.06ADA
 - 03.4994.GLADA
 - 03.4994.14ADA

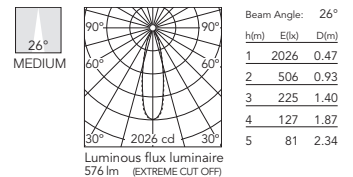

LIGHT SNIPER

Light Sniper Adjustable Round

Light Source: Power LED 11W - 910 lm - 2700K/CRI 90 / 11W - 1060 lm - 3000K/CRI 90

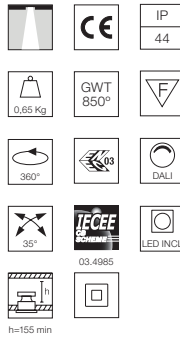
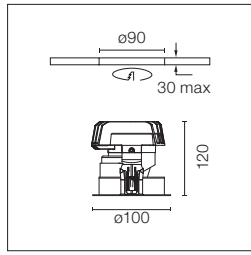

Hochleistungs LED Einbauleuchte. Fernnetzgerät mit 220-240V im Lieferumfang enthalten.

High-performance recessed luminaire with LED light source. Remote 220-240V power supply included.

2700K

- Non Dimmable
- 03.4985.06
 - 03.4985.GL
 - 03.4985.14
- Dali Version / 1-10V / Push
- 03.4985.06.DA
 - 03.4985.GL.DA
 - 03.4985.14.DA

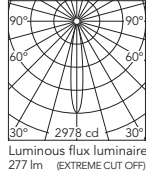

Beam Angle: 15°

h(m)	E(lx)	D(m)
1	2978	0.26
2	744	0.52
3	331	0.78
4	186	1.04
5	119	1.30

Luminous flux luminaire 277 lm (EXTREME CUT OFF)

3000K

- Non Dimmable
- 03.4984.06A
 - 03.4984.GLA
 - 03.4984.14A
- Dali Version / 1-10V / Push
- 03.4984.06ADA
 - 03.4984.GLADA
 - 03.4984.14ADA

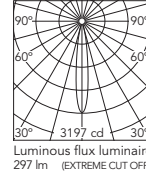

Beam Angle: 15°

h(m)	E(lx)	D(m)
1	3197	0.26
2	799	0.52
3	355	0.78
4	200	1.04
5	128	1.30

Luminous flux luminaire 297 lm (EXTREME CUT OFF)

2700K

- Non Dimmable
- 03.4997.06
 - 03.4997.GL
 - 03.4997.14
- Dali Version / 1-10V / Push
- 03.4997.06.DA
 - 03.4997.GL.DA
 - 03.4997.14.DA

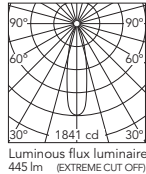

Beam Angle: 25°

h(m)	E(lx)	D(m)
1	1841	0.44
2	460	0.88
3	205	1.32
4	115	1.76
5	74	2.19

Luminous flux luminaire 445 lm (EXTREME CUT OFF)

3000K

- Non Dimmable
- 03.4996.06A
 - 03.4996.GLA
 - 03.4996.14A
- Dali Version / 1-10V / Push
- 03.4996.06ADA
 - 03.4996.GLADA
 - 03.4996.14ADA

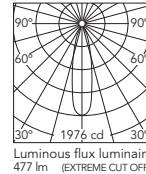

Beam Angle: 25°

h(m)	E(lx)	D(m)
1	1976	0.44
2	494	0.88
3	220	1.32
4	124	1.76
5	79	2.19

Luminous flux luminaire 477 lm (EXTREME CUT OFF)

Light Sniper Adjustable Square

Light Source: Power LED 11W - 910 lm - 2700K/CRI 90 / 11W - 1060 lm - 3000K/CRI 90

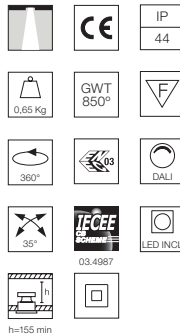
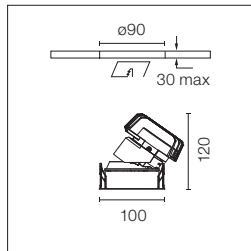

Hochleistungs LED Einbauleuchte. Fernnetzgerät mit 220-240V im Lieferumfang enthalten.

High-performance recessed luminaire with LED light source. Remote 220-240V power supply included.

2700K

- Non Dimmable
- 03.4987.06
 - 03.4987.GL
 - 03.4987.14
- Dali Version / 1-10V / Push
- 03.4987.06.DA
 - 03.4987.GL.DA
 - 03.4987.14.DA

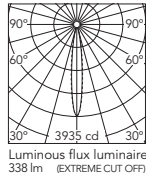

Beam Angle: 13°

h(m)	E(lx)	D(m)
1	3935	0.23
2	984	0.47
3	437	0.70
4	246	0.94
5	157	1.17

Luminous flux luminaire 338 lm (EXTREME CUT OFF)

3000K

- Non Dimmable
- 03.4986.06A
 - 03.4986.GLA
 - 03.4986.14A
- Dali Version / 1-10V / Push
- 03.4986.06ADA
 - 03.4986.GLADA
 - 03.4986.14ADA

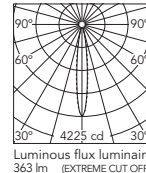

Beam Angle: 13°

h(m)	E(lx)	D(m)
1	4225	0.23
2	1056	0.47
3	469	0.70
4	264	0.94
5	169	1.17

Luminous flux luminaire 363 lm (EXTREME CUT OFF)

2700K

- Non Dimmable
- 03.4999.06
 - 03.4999.GL
 - 03.4999.14
- Dali Version / 1-10V / Push
- 03.4999.06.DA
 - 03.4999.GL.DA
 - 03.4999.14.DA

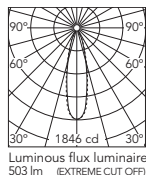

Beam Angle: 25°

h(m)	E(lx)	D(m)
1	1846	0.45
2	462	0.89
3	205	1.34
4	115	1.79
5	74	2.24

Luminous flux luminaire 503 lm (EXTREME CUT OFF)

3000K

- Non Dimmable
- 03.4998.06A
 - 03.4998.GLA
 - 03.4998.14A
- Dali Version / 1-10V / Push
- 03.4998.06ADA
 - 03.4998.GLADA
 - 03.4998.14ADA

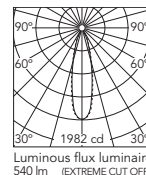

Beam Angle: 25°

h(m)	E(lx)	D(m)
1	1982	0.45
2	495	0.89
3	220	1.34
4	124	1.79
5	79	2.24

Luminous flux luminaire 540 lm (EXTREME CUT OFF)

LIGHT SNIPER

Light Sniper Wall-Washer Round

Light Source: Power LED 11W - 910 lm - 2700K/CRI 90 / 11W - 1060 lm - 3000K/CRI 90

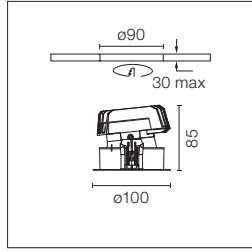

Hochleistungs LED Einbauleuchte. Fernnetzgerät mit 220-240V im Lieferumfang enthalten.

High-performance recessed luminaire with LED light source. Remote 220-240V power supply included.

2700K

Non Dimmable

03.4989.06

Dali Version / 1-10V / Push

03.4989.06.DA

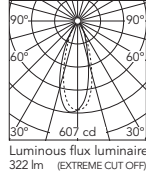

Beam Angle: 35°

h(m) E(lx) D(m)

1 607 0.63

2 152 1.26

3 67 1.90

4 38 2.53

5 24 3.16

3000K

Non Dimmable

03.4988.06A

Dali Version / 1-10V / Push

03.4988.06ADA

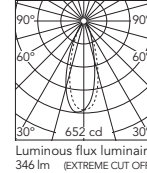

Beam Angle: 35°

h(m) E(lx) D(m)

1 652 0.63

2 163 1.26

3 72 1.90

4 41 2.53

5 26 3.16

Light Sniper Wall-Washer Square

Light Source: Power LED 11W - 910 lm - 2700K/CRI 90 / 11W - 1060 lm - 3000K/CRI 90

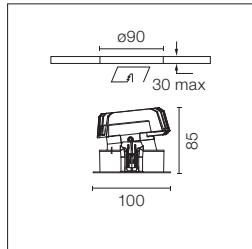

Hochleistungs LED Einbauleuchte. Fernnetzgerät mit 220-240V im Lieferumfang enthalten.

High-performance recessed luminaire with LED light source. Remote 220-240V power supply included.

2700K

Non Dimmable

03.4991.06

Dali Version / 1-10V / Push

03.4991.06.DA

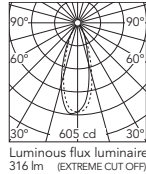

Beam Angle: 34°

h(m) E(lx) D(m)

1 605 0.61

2 151 1.23

3 67 1.84

4 38 2.46

5 24 3.07

3000K

Non Dimmable

03.4990.06A

Dali Version / 1-10V / Push

03.4990.06ADA

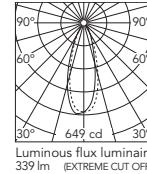

Beam Angle: 34°

h(m) E(lx) D(m)

1 649 0.61

2 162 1.23

3 72 1.84

4 41 2.46

5 26 3.07

LIGHT SNIPER

Zubehör / Accessories

Für bessere Leistungen bei der Produktfamilie Light Sniper wird folgendes Zubehör angeboten:

- Deckenschutzzubehör. Bei dem Einsatz an schwachen Decken.
- Flush-Zubehör. Es ermöglicht den Einsatz an der Wand- oder Deckenkante.
- CAN-Zubehör. Es vereinfacht den Einsatz an Betondecken. Das Zubehör muss zur Verfügung stehen, bevor die Betondecke gebaut wird.
- Farbfilter.

In order to increase the performances of the Light Sniper family, the following accessories are available:

- Accessory for ceiling protection. Recommended for delicate ceiling installation.
- "Flush" accessory, which allows a flush installation with the ceiling or wall.
- CAN accessory for installation in concrete. It facilitates installation on concrete ceilings. It is necessary to obtain and to install the accessory prior to the concrete ceiling.
- Color filters.

Runder Rahmen für Deckenanbau. 08.8239.00B



Flush ceiling round frame accessory.

Elliptische linse 08.8041.68
Elliptical lens



Viereckiger Rahmen für Deckenanbau. 08.8240.00B



Flush ceiling square frame accessory.

Honeycomb 08.8412.14
Honeycomb



Schutzzubehör für Deckeneinsatz. 1 Unit 08.8243.00
Ceiling protector accessory. 10 Units 08.8243.00.1U
50 Units 08.8243.00.5U



Einbaukörper aus Beton. 08.8250.00



Concrete instalation can.

Schutzzubehör für Deckeneinsatz. Round 08.8229.30A



Ceiling protector accessory.



Square 08.8222.30A

UT DOWNLIGHT

DESIGNED BY FLOS ARCHITECTURAL

TRIM / NO TRIM
Ø57



LIGHT SOURCE

LED ARRAY
18W
2000 lm
3000K/CRI 80
1600 lm
3000K/CRI 90
4000K/CRI 90

TRIM / NO TRIM
Ø86



LIGHT SOURCE

LED ARRAY
HIGH
PERFORMANCES
27W
3214 lm
3000K/CRI 80
2656 lm
3000K/CRI 90
2767 lm
4000K/CRI 90

□ 30 Weiss
30 White

■ 14 Schwarz
14 Black



Drehbar um 360° und schwenkbar 90°.
Can be rotated 360° and swivelled 90°.

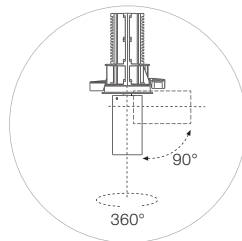

UT DOWNLIGHT

Produktbeschreibung

Innenleuchte für den Einbau mit Lichtquellen mit leistungsstarker LED-Technologie sowie DALI- und Nicht-DALI-Versionen.

Die Produktreihe ist in zwei Größen (Ø57 und Ø86) erhältlich.

In der oberen Position fungiert sie als Downlight, in der unteren Position als schwenkbarer Strahler. Der optische Körper der Leuchte besteht aus Aluminium, das unter hohem Druck eingespritzt wird und in Pulverlackierung in Weiß oder Schwarz ausgeführt ist. Fern-Netzteil im Lieferumfang enthalten.

Betriebsgerät

Netzteil für konstante Stromzufuhr mit oder ohne DALI-Steuerung 220-240V eingeschlossen.

Zubehör

- Querabschirmung, elliptische Linse, Fluterlinse und Honeycomb verfügbar.
- Installationsrahmen.

Zusatzinformationen

Schutzgrad IP20.
Schutzklasse II.
Auf normal entflammaren Oberflächen einsetzbar.

Qualitätszeichen

Das Gerät entspricht der europäischen technischen Norm EN60598-1 und den entsprechenden Zusatzregelungen.

Description

Interior lighting for embedded installation with high power LED technology light sources, in Dali and Non Dali versions.

The family is available in two sizes (Ø57 and Ø86).

In an upper position it functions as a downlight, and in a lower position it functions as a swivelling projector.

The optical body of the luminaire is manufactured in high-pressure die-cast aluminium, finished in black or white powder paint.

Remote power kit included.

Power Supply

Not dimmable or dimmable Dali 220-240V, constant current, power supply included.

Accessories

- Screening crosspiece, elliptical lens, flood lens and Honeycomb.

- No Trim installation frame.

Additional Information

IP20 protection grade.

Insulation class II.

Suitable for installation on normally inflammable surfaces.

Standard Compliance and Quality Marks

EN60598-1 European Technical Standards and any subsequent additions.



Trim



No Trim

UT DOWNLIGHT

Ut Downlight Trim Ø57

Light Source: LED Array 18W - 2000 lm - 3000K/CRI 80 / 18W - 1600 lm - 3000K/CRI 90 / 18W - 1600 lm - 4000K/CRI 90

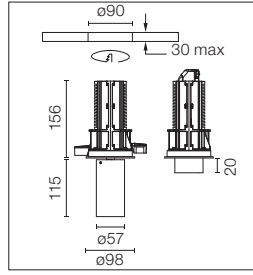

LED Einbauleuchte. Fernnetzgerät mit 220-240V, 50-60Hz inbegriffen.

Recessed luminaire with LED light source. 220-240V, 50-60Hz remote power supply included.

- 3000K - CRI 80**
Non Dimmable
- 09.4510.30A
 - 09.4510.14A
 - Dali Version
 - 09.4510.30ADA
 - 09.4510.14ADA

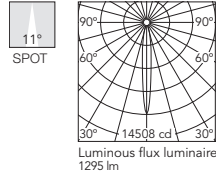

Beam Angle: 11°

h(m)	E(lx)	D(m)
1	14508	0.19
2	3627	0.39
3	1612	0.58
4	907	0.77
5	580	0.97

- 4000K - CRI 90**
Non Dimmable
- 09.4516.30A
 - 09.4516.14A
 - Dali Version
 - 09.4516.30ADA
 - 09.4516.14ADA

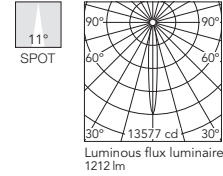

Beam Angle: 11°

h(m)	E(lx)	D(m)
1	13577	0.19
2	3394	0.39
3	1509	0.58
4	849	0.77
5	543	0.97

- 3000K - CRI 90**
Non Dimmable
- 09.4513.30A
 - 09.4513.14A
 - Dali Version
 - 09.4513.30ADA
 - 09.4513.14ADA

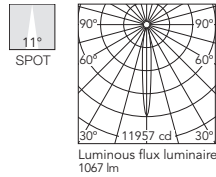

Beam Angle: 11°

h(m)	E(lx)	D(m)
1	11957	0.19
2	2989	0.39
3	1329	0.58
4	747	0.77
5	478	0.97

- 3000K - CRI 80**
Non Dimmable
- 09.4511.30A
 - 09.4511.14A
 - Dali Version
 - 09.4511.30ADA
 - 09.4511.14ADA

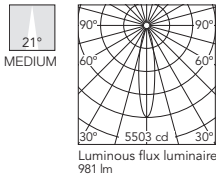

Beam Angle: 21°

h(m)	E(lx)	D(m)
1	5503	0.36
2	1376	0.72
3	611	1.09
4	344	1.45
5	220	1.81

- 4000K - CRI 90**
Non Dimmable
- 09.4517.30A
 - 09.4517.14A
 - Dali Version
 - 09.4517.30ADA
 - 09.4517.14ADA

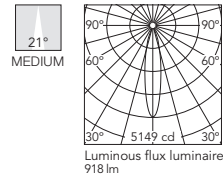

Beam Angle: 21°

h(m)	E(lx)	D(m)
1	5149	0.36
2	1287	0.72
3	572	1.09
4	322	1.45
5	206	1.81

- 3000K - CRI 90**
Non Dimmable
- 09.4514.30A
 - 09.4514.14A
 - Dali Version
 - 09.4514.30ADA
 - 09.4514.14ADA

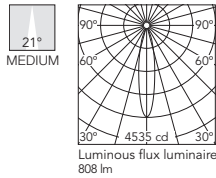

Beam Angle: 21°

h(m)	E(lx)	D(m)
1	4535	0.36
2	1134	0.72
3	504	1.09
4	283	1.45
5	181	1.81

- 3000K - CRI 80**
Non Dimmable
- 09.4512.30A
 - 09.4512.14A
 - Dali Version
 - 09.4512.30ADA
 - 09.4512.14ADA

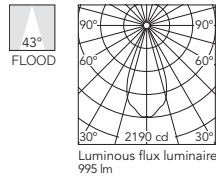

Beam Angle: 43°

h(m)	E(lx)	D(m)
1	2190	0.79
2	548	1.58
3	243	2.37
4	137	3.16
5	88	3.95

- 4000K - CRI 90**
Non Dimmable
- 09.4518.30A
 - 09.4518.14A
 - Dali Version
 - 09.4518.30ADA
 - 09.4518.14ADA

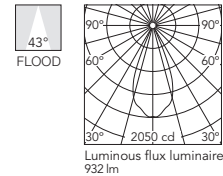

Beam Angle: 43°

h(m)	E(lx)	D(m)
1	2050	0.79
2	512	1.58
3	228	2.37
4	128	3.16
5	82	3.95

- 3000K - CRI 90**
Non Dimmable
- 09.4515.30A
 - 09.4515.14A
 - Dali Version
 - 09.4515.30ADA
 - 09.4515.14ADA

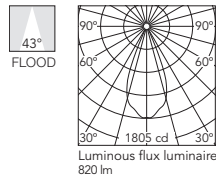

Beam Angle: 43°

h(m)	E(lx)	D(m)
1	1805	0.79
2	451	1.58
3	201	2.37
4	113	3.16
5	72	3.95

UT DOWNLIGHT

Ut Downlight No Trim Ø57

Light Source: LED Array 18W - 2000 lm - 3000K/CRI 80 / 18W - 1600 lm - 3000K/CRI 90 / 18W - 1600 lm - 4000K/CRI 90

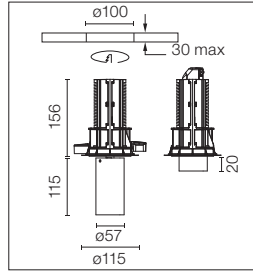

LED Einbauleuchte. Fernnetzgerät mit 220-240V, 50-60Hz inbegriffen.

Recessed luminaire with LED light source. 220-240V, 50-60Hz remote power supply included.

Der Rahmen für das Einbaugehäuse ist getrennt zu bestellen.

Pre-installation frame must be ordered separately.

- 3000K - CRI 80**
Non Dimmable
- 09.4519.30A
 - 09.4519.14A
 - Dali Version
 - 09.4519.30ADA
 - 09.4519.14ADA

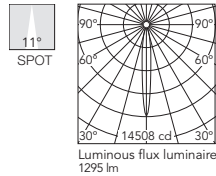

Beam Angle: 11°

h(m)	E(lx)	D(m)
1	14508	0.19
2	3627	0.39
3	1612	0.58
4	907	0.77
5	580	0.97

- 4000K - CRI 90**
Non Dimmable
- 09.4525.30A
 - 09.4525.14A
 - Dali Version
 - 09.4525.30ADA
 - 09.4525.14ADA

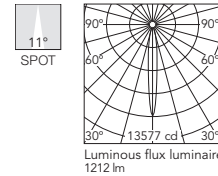

Beam Angle: 11°

h(m)	E(lx)	D(m)
1	13577	0.19
2	3394	0.39
3	1509	0.58
4	849	0.77
5	543	0.97

- 3000K - CRI 90**
Non Dimmable
- 09.4522.30A
 - 09.4522.14A
 - Dali Version
 - 09.4522.30ADA
 - 09.4522.14ADA

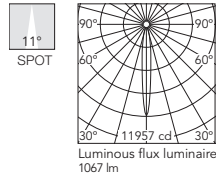

Beam Angle: 11°

h(m)	E(lx)	D(m)
1	11957	0.19
2	2989	0.39
3	1329	0.58
4	747	0.77
5	478	0.97

- 3000K - CRI 80**
Non Dimmable
- 09.4520.30A
 - 09.4520.14A
 - Dali Version
 - 09.4520.30ADA
 - 09.4520.14ADA

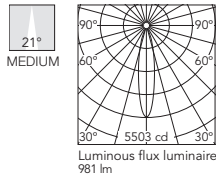

Beam Angle: 21°

h(m)	E(lx)	D(m)
1	5503	0.36
2	1376	0.72
3	611	1.09
4	344	1.45
5	220	1.81

- 4000K - CRI 90**
Non Dimmable
- 09.4526.30A
 - 09.4526.14A
 - Dali Version
 - 09.4526.30ADA
 - 09.4526.14ADA

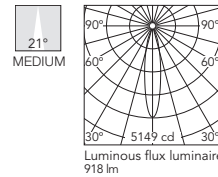

Beam Angle: 21°

h(m)	E(lx)	D(m)
1	5149	0.36
2	1287	0.72
3	572	1.09
4	322	1.45
5	206	1.81

- 3000K - CRI 90**
Non Dimmable
- 09.4523.30A
 - 09.4523.14A
 - Dali Version
 - 09.4523.30ADA
 - 09.4523.14ADA

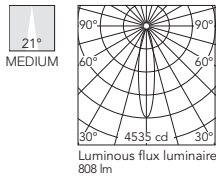

Beam Angle: 21°

h(m)	E(lx)	D(m)
1	4535	0.36
2	1134	0.72
3	504	1.09
4	283	1.45
5	181	1.81

- 3000K - CRI 80**
Non Dimmable
- 09.4521.30A
 - 09.4521.14A
 - Dali Version
 - 09.4521.30ADA
 - 09.4521.14ADA

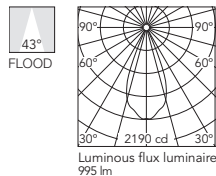

Beam Angle: 43°

h(m)	E(lx)	D(m)
1	2190	0.79
2	548	1.58
3	243	2.37
4	137	3.16
5	88	3.95

- 4000K - CRI 90**
Non Dimmable
- 09.4527.30A
 - 09.4527.14A
 - Dali Version
 - 09.4527.30ADA
 - 09.4527.14ADA

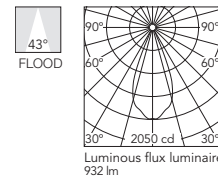

Beam Angle: 43°

h(m)	E(lx)	D(m)
1	2050	0.79
2	512	1.58
3	228	2.37
4	128	3.16
5	82	3.95

- 3000K - CRI 90**
Non Dimmable
- 09.4524.30A
 - 09.4524.14A
 - Dali Version
 - 09.4524.30ADA
 - 09.4524.14ADA

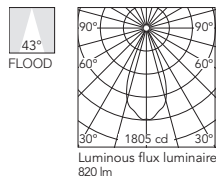

Beam Angle: 43°

h(m)	E(lx)	D(m)
1	1805	0.79
2	451	1.58
3	201	2.37
4	113	3.16
5	72	3.95

UT DOWNLIGHT

Ut Downlight Trim Ø86

Light Source: LED Array High Performances 27W - 3214 lm - 3000K/CRI 80 / 27W - 2656 lm - 3000K/CRI 90 / 27W - 2767 lm - 4000K/CRI 90

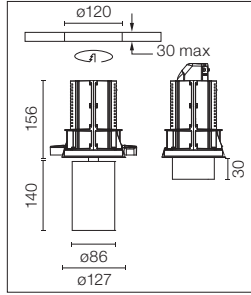

LED Einbauleuchte. Fernnetzgerät mit 220-240V, 50-60Hz inbegriffen.

Recessed luminaire with LED light source. 220-240V, 50-60Hz remote power supply included.

3000K - CRI 80

- Non Dimmable
 09.4910.30A
 09.4910.14A
 Dali Version
 09.4910.30ADA
 09.4910.14ADA

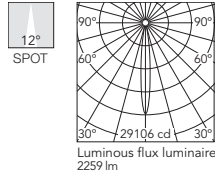

Beam Angle: 12°

h(m)	E(lx)	D(m)
1	29106	0.21
2	7277	0.41
3	3234	0.62
4	1819	0.82
5	1164	1.03

Luminous flux luminaire 2259 lm

4000K - CRI 90

- Non Dimmable
 09.4916.30A
 09.4916.14A
 Dali Version
 09.4916.30ADA
 09.4916.14ADA

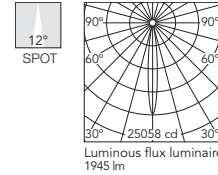

Beam Angle: 12°

h(m)	E(lx)	D(m)
1	25058	0.21
2	6265	0.41
3	2784	0.62
4	1566	0.82
5	1002	1.03

Luminous flux luminaire 1945 lm

3000K - CRI 90

- Non Dimmable
 09.4913.30A
 09.4913.14A
 Dali Version
 09.4913.30ADA
 09.4913.14ADA

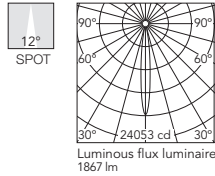

Beam Angle: 12°

h(m)	E(lx)	D(m)
1	24053	0.21
2	6013	0.41
3	2673	0.62
4	1503	0.82
5	962	1.03

Luminous flux luminaire 1867 lm

3000K - CRI 80

- Non Dimmable
 09.4911.30A
 09.4911.14A
 Dali Version
 09.4911.30ADA
 09.4911.14ADA

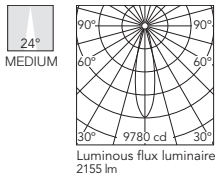

Beam Angle: 24°

h(m)	E(lx)	D(m)
1	9780	0.43
2	2445	0.86
3	1087	1.28
4	611	1.71
5	391	2.14

Luminous flux luminaire 2155 lm

4000K - CRI 90

- Non Dimmable
 09.4917.30A
 09.4917.14A
 Dali Version
 09.4917.30ADA
 09.4917.14ADA

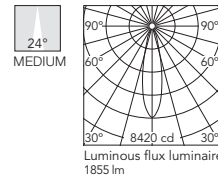

Beam Angle: 24°

h(m)	E(lx)	D(m)
1	8420	0.43
2	2105	0.86
3	936	1.28
4	526	1.71
5	337	2.14

Luminous flux luminaire 1855 lm

3000K - CRI 90

- Non Dimmable
 09.4914.30A
 09.4914.14A
 Dali Version
 09.4914.30ADA
 09.4914.14ADA

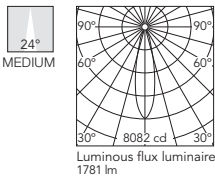

Beam Angle: 24°

h(m)	E(lx)	D(m)
1	8082	0.43
2	2020	0.86
3	898	1.28
4	505	1.71
5	323	2.14

Luminous flux luminaire 1781 lm

3000K - CRI 80

- Non Dimmable
 09.4912.30A
 09.4912.14A
 Dali Version
 09.4912.30ADA
 09.4912.14ADA

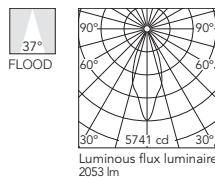

Beam Angle: 37°

h(m)	E(lx)	D(m)
1	5741	0.67
2	1435	1.34
3	638	2.01
4	359	2.69
5	230	3.36

Luminous flux luminaire 2053 lm

4000K - CRI 90

- Non Dimmable
 09.4918.30A
 09.4918.14A
 Dali Version
 09.4918.30ADA
 09.4918.14ADA

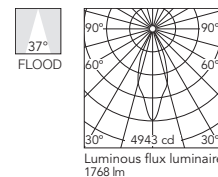

Beam Angle: 37°

h(m)	E(lx)	D(m)
1	4943	0.67
2	1236	1.34
3	549	2.01
4	309	2.69
5	198	3.36

Luminous flux luminaire 1768 lm

3000K - CRI 90

- Non Dimmable
 09.4915.30A
 09.4915.14A
 Dali Version
 09.4915.30ADA
 09.4915.14ADA

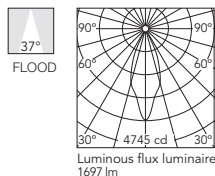

Beam Angle: 37°

h(m)	E(lx)	D(m)
1	4745	0.67
2	1186	1.34
3	527	2.01
4	297	2.69
5	190	3.36

Luminous flux luminaire 1697 lm

UT DOWNLIGHT

Ut Downlight No Trim Ø86

Light Source: LED Array High Performances 27W - 3214 lm - 3000K/CRI 80 / 27W - 2656 lm - 3000K/CRI 90 / 27W - 2767 lm - 4000K/CRI 90

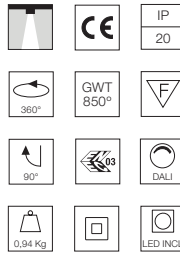
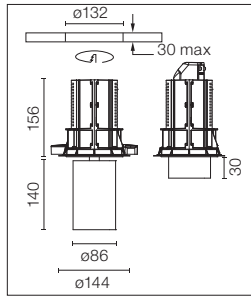

LED Einbauleuchte. Fernnetzgerät mit 220-240V, 50-60Hz inbegriffen.

Recessed luminaire with LED light source. 220-240V, 50-60Hz remote power supply included.

Der Rahmen für das Einbaugesäuse ist getrennt zu bestellen.

Pre-installation frame must be ordered separately.

3000K - CRI 80

Non Dimmable

09.4919.30A

09.4919.14A

Dali Version

09.4919.30ADA

09.4919.14ADA

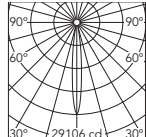

Beam Angle: 12°

h(m)	E(lx)	D(m)
1	29106	0.21
2	7277	0.41
3	3234	0.62
4	1819	0.82
5	1164	1.03

Luminous flux luminaire 2259 lm

4000K - CRI 90

Non Dimmable

09.4925.30A

09.4925.14A

Dali Version

09.4925.30ADA

09.4925.14ADA

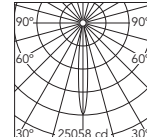

Beam Angle: 12°

h(m)	E(lx)	D(m)
1	25058	0.21
2	6265	0.41
3	2784	0.62
4	1566	0.82
5	1002	1.03

Luminous flux luminaire 1945 lm

3000K - CRI 90

Non Dimmable

09.4922.30A

09.4922.14A

Dali Version

09.4922.30ADA

09.4922.14ADA

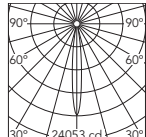

Beam Angle: 12°

h(m)	E(lx)	D(m)
1	24053	0.21
2	6013	0.41
3	2673	0.62
4	1503	0.82
5	962	1.03

Luminous flux luminaire 1867 lm

3000K - CRI 80

Non Dimmable

09.4920.30A

09.4920.14A

Dali Version

09.4920.30ADA

09.4920.14ADA

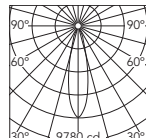

Beam Angle: 24°

h(m)	E(lx)	D(m)
1	9780	0.43
2	2445	0.86
3	1087	1.28
4	611	1.71
5	391	2.14

Luminous flux luminaire 2155 lm

4000K - CRI 90

Non Dimmable

09.4926.30A

09.4926.14A

Dali Version

09.4926.30ADA

09.4926.14ADA

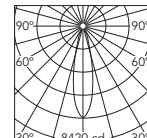

Beam Angle: 24°

h(m)	E(lx)	D(m)
1	8420	0.43
2	2105	0.86
3	936	1.28
4	526	1.71
5	337	2.14

Luminous flux luminaire 1855 lm

3000K - CRI 90

Non Dimmable

09.4923.30A

09.4923.14A

Dali Version

09.4923.30ADA

09.4923.14ADA

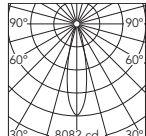

Beam Angle: 24°

h(m)	E(lx)	D(m)
1	8082	0.43
2	2020	0.86
3	898	1.28
4	505	1.71
5	323	2.14

Luminous flux luminaire 1781 lm

3000K - CRI 80

Non Dimmable

09.4921.30A

09.4921.14A

Dali Version

09.4921.30ADA

09.4921.14ADA

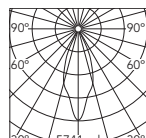

Beam Angle: 37°

h(m)	E(lx)	D(m)
1	5741	0.67
2	1435	1.34
3	638	2.01
4	359	2.69
5	230	3.36

Luminous flux luminaire 2053 lm

4000K - CRI 90

Non Dimmable

09.4927.30A

09.4927.14A

Dali Version

09.4927.30ADA

09.4927.14ADA

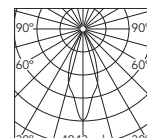

Beam Angle: 37°

h(m)	E(lx)	D(m)
1	4943	0.67
2	1236	1.34
3	549	2.01
4	309	2.69
5	198	3.36

Luminous flux luminaire 1768 lm

3000K - CRI 90

Non Dimmable

09.4924.30A

09.4924.14A

Dali Version

09.4924.30ADA

09.4924.14ADA

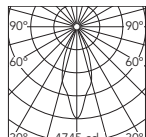

Beam Angle: 37°

h(m)	E(lx)	D(m)
1	4745	0.67
2	1186	1.34
3	527	2.01
4	297	2.69
5	190	3.36

Luminous flux luminaire 1697 lm

UT DOWNLIGHT

Zubehör / Accessories

Querabschirmung, Linsen und Honeycomb können ohne Befestigungszubehör direkt in den Leuchtenkopf eingesetzt werden.

UT Downlight Ø86: Honeycomb + Linse können gleichzeitig verwendet werden.

Screening crosspiece, lenses and Honeycomb directly installable on the head of the luminaire without needing any fastening accessory.

UT Downlight Ø86: Installation compatible with Honeycomb + Linse at the same time.

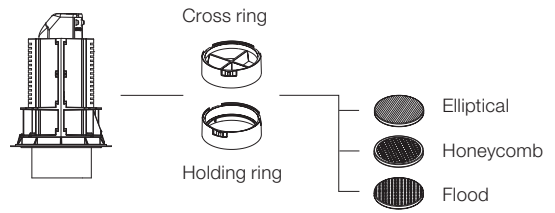

UT Downlight Ø57

Rahmen für Einbaugehäuse
No Trim.
Installation frame No Trim.



08.8994.30
08.8994.14

Querabschirmung
Screening crosspiece



08.8429.00

Elliptische linse
Elliptical lens



08.8431.00

Floodlinse
Flood lens



08.8432.00

For Spot & Medium optics

Honeycomb
Honeycomb



08.8428.00

Konische Abschirmung
Snoot shielding cone

88



08.0526.00
08.0526.40
08.0526.BW

UT Downlight Ø86

Rahmen für Einbaugehäuse
No Trim.
Installation frame No Trim.



08.8995.30
08.8995.14

Haltering
Holding ring



08.8410.00

Querabschirmung
Screening crosspiece



08.8411.00

Elliptische linse
Elliptical lens



08.8163.68

Floodlinse
Flood lens



08.8175.68

For Spot & Medium optics







Honeycomb
Honeycomb



08.8495.14

LIGHT SUPPLY

DESIGNED BY FLOS ARCHITECTURAL

FIXED TRIM / NO TRIM	ADJUSTABLE TRIM / NO TRIM	WALL-WASHER TRIM / NO TRIM
		
		
LIGHT SOURCE PHOSPHOR LED 26W 2285 lm 3000K/CRI 98 28W 3000 lm 4000K/CRI 80	LIGHT SOURCE PHOSPHOR LED 26W 2285 lm 3000K/CRI 98 28W 3000 lm 4000K/CRI 80	LIGHT SOURCE PHOSPHOR LED 26W 2285 lm 3000K/CRI 98 28W 3000 lm 4000K/CRI 80
LIGHT SOURCE LED ARRAY HIGH PERFORMANCES 29W 3402 lm 3000K/CRI 80 2811 lm 3000K/CRI 90 2929 lm 4000K/CRI 90	LIGHT SOURCE LED ARRAY HIGH PERFORMANCES 30,1W 3402 lm 3000K/CRI 80 2811 lm 3000K/CRI 90 2929 lm 4000K/CRI 90	LIGHT SOURCE LED ARRAY HIGH PERFORMANCES 33,2W 3770 lm 3000K/CRI 80 3116 lm 3000K/CRI 90 3246 lm 4000K/CRI 90

Light Supply Adjustable

40 Weiss
40 White

14 Schwarz
14 Black



Light Supply Fixed & Wall-Washer Trim

Außenring / External Ring

Weiss
White

Schwarz
Black

Reflektor / Reflector

Aluminium
Aluminium

Weiss
White

Aluminium
Aluminium

Weiss
White



Drehbar um 365° und schwenkbar 35°.
Can be rotated 365° and swivelled 35°.

Light Supply Adjustable

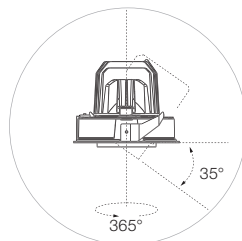

Produktbeschreibung

Neue Downlight-Familie, konzipiert für maximalen Lichtfluss in kompaktem Design. 165 mm Durchmesser bieten dank LED-Modulen modernster Technologie bis zu 3000 lm.

Erhältlich in fester, verstellbarer und Wandfluter-Ausführung.

Die verstellbare Ausführung besitzt eine demontierbare zylinderförmige Optikhalterung, die sich einfach aus der Leuchte herausdrehen lässt, so dass die Elektronik voll zugänglich ist und das verfügbare technische Zubehör installiert werden kann.

Weiteres Zubehör in Form von Strahlern mit Spot-, Medium- und Fluter-Optik ermöglicht höchste Flexibilität und nachträgliche Optimierung der Installation, so dass eine veränderte Lichtstrahldimensionierung möglich ist, ohne dass dazu die Halterung von der Decke entfernt werden muss.

Alle No Trim Versionen können in einen Standard-Vormontagerahmen aus Metall oder zum vollkommenen Einbau in eine Gipskartondecke in eine Soft Technology Montageplatte eingebaut werden.

Reflektoren

Durchgehend Reinaluminium mit Spiegel-Finish. Symmetrischer Rundspot: Medium und Fluter für die verstellbare Ausführung, Fluter für die feste Ausführung.

Einspeisung

Kabel enthalten, bereit für Anschluss an mitgelieferte Fernsteuerung. Versionen ohne Ansteuerung und 1-10V Dimmausführung auf Wunsch erhältlich.

Zubehör

Für verstellbare Ausführung:
- Elliptische Verteilerlinse.
- Honeycomb.
- Austauschreflektor für Spot-, Medium- und Fluteroptikausführung.

Für alle No Trim Ausführungen:
- Vormontagerahmen oder Soft Architecture Montageplatte für verstellbare Ausführung.

Zusatzinformationen

Bei den ausrichtbaren Ausführungen: Schwenkwinkel 35° und Drehwinkel 365°. Schutzgrad IP23, IP44 je nach Modell. Schutzklasse II.

Qualitätszeichen

Das Gerät entspricht der europäischen technischen Norm EN60598-1 und den entsprechenden Zusatzregelungen.

Description

New downlight family developed to get a maximum flux in a compact design. 165mm diameter offering up to 3000 lm thanks to latest technology LED modules.

Available in fixed, adjustable and wall-washer version. Adjustable version features a dismantlable optic support cylinder, to be easily unscrewed from the luminaire, in order to completely access the electronic and to install the professional accessories available.

To offer maximum flexibility and installation evolution in time, reflector of spot, medium and flood optic are also available as accessories, to change the light beam dimension without even needing to dismount the fixture from the ceiling.

All Light Supply No Trim versions can be mounted in a standard pre-installation metal frame or, for total integration in plasterboard ceiling, in a Soft Technology installation plate.

Reflectors

All super pure aluminum with specular finish. Circular roto symmetrical spot, medium and flood for the adjustable version, flood for the fixed version.

Power Supply

Cabling included, ready to be powered by included remote driver. Versions without driver and 1-10V dimmable available on request.

Accessories

For adjustable version:
- Elliptical distribution lens.
- Honeycomb.
- Spare part of spot, medium, flood optics reflectors.

For all No Trim versions:
- Pre-installation frame or Soft Architecture installation plate for adjustable version.

Additional Information

In the adjustable versions, 35° tilt and 365° rotation. IP23, IP44 protection grade depending on the versions. Insulation class II.

Standard Compliance and Quality Marks

EN60598-1 European Technical Standards and any subsequent additions.



Fixed / Adjustable /
Wall-Washer /
No Trim



Fixed
No Trim



Adjustable
No Trim



Wall-Washer
No Trim

LIGHT SUPPLY



Die LED-Module mit Phosphor-LED erreichen dank der Remote-Phosphor-Technologie je nach Modell einen Farbwiedergabeindex von bis zu 98 und bieten die bestmögliche Lichtqualität und Wahrnehmung von Gegenständen und Raum.

Alle Versionen mit 3000 K sind auf Anfrage in der "Händlerversion" erhältlich. Dieses Modell ist mit einem speziellen Phosphor-LED-Modul ausgerüstet, das die Lichtfrequenz einer Halogen-Metaldampfampe reproduziert und in puncto Energieeinsparung und Zuverlässigkeit die heutzutage üblichen Vorteile bietet.

Die innovative Lösung verbessert nicht nur die Farbwahrnehmung und die Darstellung von weißem Licht, sondern verringert auch die ultraviolette Strahlung, die für Kunstwerke schädlich ist, weshalb sie sich insbesondere für die kommerzielle Anwendung und die Nutzung in Museen eignet.

Die LED-Module der Modellreihe LED Array entsprechen dem neuesten Stand der Technik, der sich durch eine geringere Durchschnittstemperatur im elektronischen Betrieb auszeichnet. Dank dieser Eigenschaft kann die Lichtquelle, innerhalb der Sicherheitsparameter, mit einer höheren Leistung betrieben werden und einen 20 % größeren Lichtstrom erzeugen.

Thanks to remote-phosphor technology, the LED modules of the Phosphor LED version offer maximum quality light, the perception of objects and spaces, reaching chromatic reproduction indices of 98, depending on the version.

All the 3000K versions are available under request in the "Retail version". This option has a special Phosphor LED module that, with all the advantages regarding energy saving and reliability available on the market, reproduces the frequency of the light of a metal halide lamp.

This innovative solution improves the perception of colours and the representation of white, in addition to reducing the radiation of the violet spectrum, damaging to works of art, so, it is especially indicated for commercial and museum purposes.

The LED modules installed on the LED Array versions have cutting-edge technology that permit a lower average temperature in the electronics.

Thanks to this feature, the luminaire can operate at a higher power inside the safety parameters, yet still offer 20% added luminous flux.

LIGHT SUPPLY

Light Supply Fixed Trim

Light Source: Phosphor LED 26W - 2285 lm - 3000K/CRI 98 / 28W - 3000 lm - 4000K/CRI 80

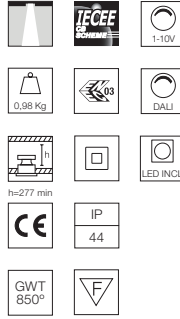
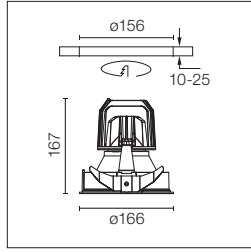

LED Einbauleuchte. Fernnetzgerät mit 220/240V im Lieferumfang enthalten.

Recessed luminaire with LED light source. Remote 220/240V power supply included.

E= Außenfarbe
I= Innenfarbe.

E= External Finish
I= Internal Finish.

Light Supply Fixed No Trim

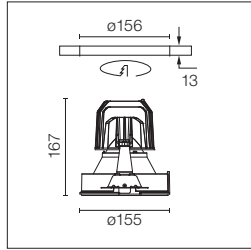

Vorinstallationsrahmen. Muss separat bestellt werden.

Pre-installation frame. To be ordered separately.

3000K - CRI 98

Trim

- 03.6611.3B
- 03.6611.3C
- Dali Version/1-10V
- 03.6611.3B.DA
- 03.6611.3C.DA

- 03.6611.1B
- 03.6611.1C
- Dali Version/1-10V

- 03.6611.1B.DA
- 03.6611.1C.DA

No Trim

- 03.6626.40
- 03.6626.06
- Dali Version/1-10V
- 03.6626.40.DA
- 03.6626.06.DA

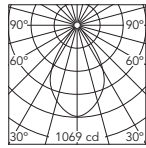

Beam Angle: 65°

h(m)	E(k)	D(m)
1	1069	1.27
2	267	2.54
3	119	3.80
4	67	5.07
5	43	6.34

Luminous flux luminaire
1158 lm (EXTREME CUT OFF)
@White Reflector

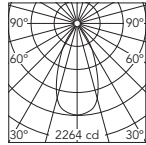

Beam Angle: 49°

h(m)	E(k)	D(m)
1	2264	0.91
2	566	1.81
3	252	2.72
4	142	3.63
5	91	4.54

Luminous flux luminaire
1576 lm (EXTREME CUT OFF)
@Aluminium Reflector

4000K - CRI 80

Trim

- 03.6610.3B
- 03.6610.3C
- Dali Version/1-10V
- 03.6610.3B.DA
- 03.6610.3C.DA

- 03.6610.1B
- 03.6610.1C
- Dali Version/1-10V

- 03.6610.1B.DA
- 03.6610.1C.DA

No Trim

- 03.6625.40
- 03.6625.06
- Dali Version/1-10V
- 03.6625.40.DA
- 03.6625.06.DA

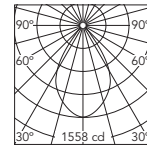

Beam Angle: 65°

h(m)	E(k)	D(m)
1	1558	1.27
2	390	2.55
3	173	3.82
4	97	5.10
5	62	6.37

Luminous flux luminaire
1696 lm (EXTREME CUT OFF)
@White Reflector

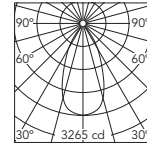

Beam Angle: 49°

h(m)	E(k)	D(m)
1	3265	0.91
2	816	1.81
3	363	2.72
4	204	3.62
5	131	4.53

Luminous flux luminaire
2270 lm (EXTREME CUT OFF)
@Aluminium Reflector

LIGHT SUPPLY

Light Supply Adjustable Trim

Light Source: Phosphor LED 26W - 2285 lm - 3000K/CRI 98

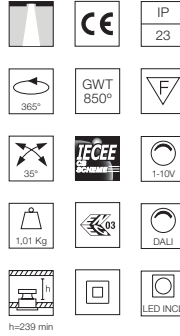
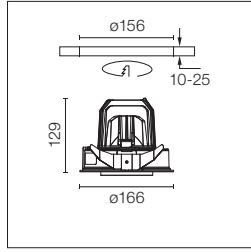

LED Einbauleuchte. Fernnetzgerät mit 220/240V im Lieferumfang enthalten.

Recessed luminaire with LED light source. Remote 220/240V power supply included.

Light Supply Adjustable No Trim

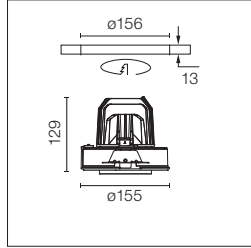

Vormontagerahmen oder Soft Architecture Montageplatte für No Trim Ausführung. Muss separat bestellt werden.

Pre-installation frame or Soft Architecture installation plate for No Trim installation. To be ordered separately.

3000K - CRI 98

Trim

- 03.6606.40
- 03.6606.14
- Dali Version/1-10V
- 03.6606.40.DA
- 03.6606.14.DA

No Trim

- 03.6621.40
- 03.6621.14
- Dali Version/1-10V
- 03.6621.40.DA
- 03.6621.14.DA

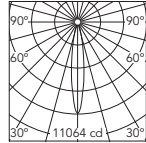

Beam Angle: 16°		
h(m)	E(lx)	D(m)
1	11064	0.28
2	2766	0.56
3	1229	0.84
4	692	1.12
5	443	1.40

Luminous flux luminaire 1363 lm (EXTREME CUT OFF)

4000K - CRI 80

Trim

- 03.6603.40
- 03.6603.14
- Dali Version/1-10V
- 03.6603.40.DA
- 03.6603.14.DA

No Trim

- 03.6618.40
- 03.6618.14
- Dali Version/1-10V
- 03.6618.40.DA
- 03.6618.14.DA

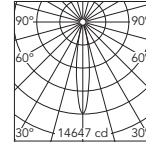

Beam Angle: 16°		
h(m)	E(lx)	D(m)
1	14647	0.29
2	3662	0.58
3	1627	0.87
4	915	1.15
5	586	1.44

Luminous flux luminaire 1871 lm (EXTREME CUT OFF)

3000K - CRI 98

Trim

- 03.6607.40
- 03.6607.14
- Dali Version/1-10V
- 03.6607.40.DA
- 03.6607.14.DA

No Trim

- 03.6622.40
- 03.6622.14
- Dali Version/1-10V
- 03.6622.40.DA
- 03.6622.14.DA

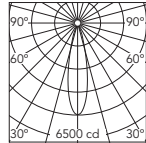

Beam Angle: 24°		
h(m)	E(lx)	D(m)
1	6500	0.42
2	1625	0.84
3	722	1.27
4	406	1.69
5	260	2.11

Luminous flux luminaire 1297 lm (EXTREME CUT OFF)

4000K - CRI 80

Trim

- 03.6604.40
- 03.6604.14
- Dali Version/1-10V
- 03.6604.40.DA
- 03.6604.14.DA

No Trim

- 03.6619.40
- 03.6619.14
- Dali Version/1-10V
- 03.6619.40.DA
- 03.6619.14.DA

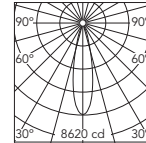

Beam Angle: 24°		
h(m)	E(lx)	D(m)
1	8620	0.42
2	2155	0.85
3	958	1.27
4	539	1.70
5	345	2.12

Luminous flux luminaire 1743 lm (EXTREME CUT OFF)

3000K - CRI 98

Trim

- 03.6608.40
- 03.6608.14
- Dali Version/1-10V
- 03.6608.40.DA
- 03.6608.14.DA

No Trim

- 03.6623.40
- 03.6623.14
- Dali Version/1-10V
- 03.6623.40.DA
- 03.6623.14.DA

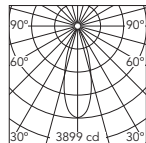

Beam Angle: 33°		
h(m)	E(lx)	D(m)
1	3899	0.59
2	975	1.18
3	433	1.77
4	244	2.37
5	156	2.96

Luminous flux luminaire 1292 lm (EXTREME CUT OFF)

4000K - CRI 80

Trim

- 03.6605.40
- 03.6605.14
- Dali Version/1-10V
- 03.6605.40.DA
- 03.6605.14.DA

No Trim

- 03.6620.40
- 03.6620.14
- Dali Version/1-10V
- 03.6620.40.DA
- 03.6620.14.DA

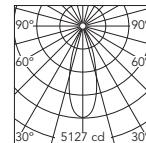

Beam Angle: 33°		
h(m)	E(lx)	D(m)
1	5127	0.60
2	1282	1.19
3	570	1.79
4	320	2.39
5	205	2.99

Luminous flux luminaire 1725 lm (EXTREME CUT OFF)

LIGHT SUPPLY

Light Supply Wall-Washer Trim

Light Source: Phosphor LED 26W - 2285 lm - 3000K/CRI 98 / 28W - 3000 lm - 4000K/CRI 80

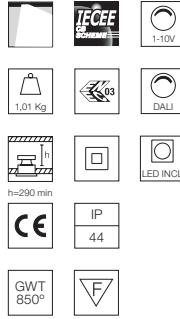
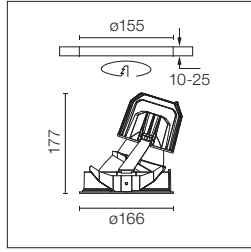

LED Einbauleuchte. Fernnetzgerät mit 220/240V im Lieferumfang enthalten.

Recessed luminaire with LED light source. Remote 220/240V power supply included.

E= Außenfarbe
I= Innenfarbe.

E= External Finish
I= Internal Finish.

Light Supply Wall-Washer No Trim

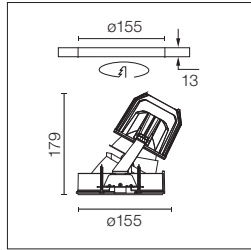

Vorinstallationsrahmen. Muss separat bestellt werden.

Pre-installation frame. To be ordered separately.

3000K - CRI 98

Trim

- 03.6614.3B
- 03.6614.3C
- Dali Version/1-10V
- 03.6614.3B.DA
- 03.6614.3C.DA

- 03.6614.1B
- 03.6614.1C
- Dali Version/1-10V

- 03.6614.1B.DA
- 03.6614.1C.DA

No Trim

- 03.6629.40
- 03.6629.06
- Dali Version/1-10V
- 03.6629.40.DA
- 03.6629.06.DA

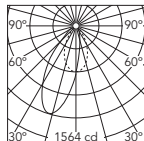

Beam Angle: 38°

h(m)	E(k)	D(m)
1	1564	0.77
2	391	1.55
3	174	2.32
4	98	3.09
5	63	3.86

Luminous flux luminaire
1355 lm (EXTREME CUT OFF)
@White Reflector

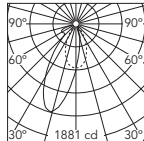

Beam Angle: 35°

h(m)	E(k)	D(m)
1	1881	0.71
2	470	1.41
3	209	2.12
4	118	2.83
5	75	3.53

Luminous flux luminaire
1401 lm (EXTREME CUT OFF)
@Aluminium Reflector

4000K - CRI 80

Trim

- 03.6613.3B
- 03.6613.3C
- Dali Version/1-10V
- 03.6613.3B.DA
- 03.6613.3C.DA

- 03.6613.1B
- 03.6613.1C
- Dali Version/1-10V

- 03.6613.1B.DA
- 03.6613.1C.DA

No Trim

- 03.6628.40
- 03.6628.06
- Dali Version/1-10V
- 03.6628.40.DA
- 03.6628.06.DA

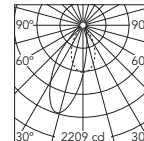

Beam Angle: 37°

h(m)	E(k)	D(m)
1	2209	0.76
2	552	1.53
3	245	2.29
4	138	3.06
5	88	3.82

Luminous flux luminaire
1918 lm (EXTREME CUT OFF)
@White Reflector

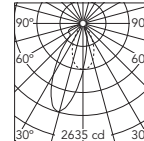

Beam Angle: 35°

h(m)	E(k)	D(m)
1	2635	0.70
2	659	1.40
3	293	2.10
4	165	2.79
5	105	3.49

Luminous flux luminaire
1967 lm (EXTREME CUT OFF)
@Aluminium Reflector

LIGHT SUPPLY

Light Supply Fixed Trim

Light Source: LED Array High Performances 29W - 3402 lm - 3000K/CRI 80 / 29W - 2811 lm - 3000K/CRI 90 / 29W - 2929 lm - 4000K/CRI 90

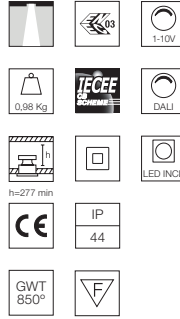
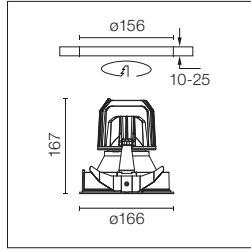

LED Einbauleuchte. Fernnetzgerät mit 220/240V im Lieferumfang enthalten.

Recessed luminaire with LED light source. Remote 220/240V power supply included.

E= Außenfarbe
I= Innenfarbe.

E= External Finish
I= Internal Finish.

Light Supply Fixed No Trim

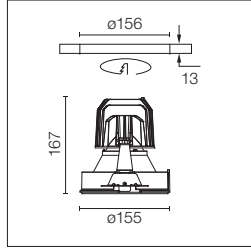

Vorinstallationsrahmen. Muss separat bestellt werden.

Pre-installation frame. To be ordered separately.

3000K - CRI 90

Trim

- E I 03.6811.3BA
- E I 03.6811.3CA
- E I Dali Version/1-10V
- E I 03.6811.3BADA
- E I 03.6811.3CADA

No Trim

- E I 03.6811.1BA
- E I 03.6811.1CA
- E I Dali Version/1-10V
- E I 03.6811.1BADA
- E I 03.6811.1CADA

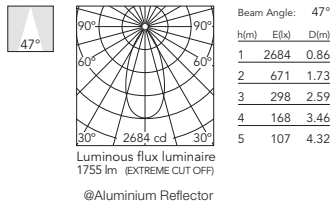
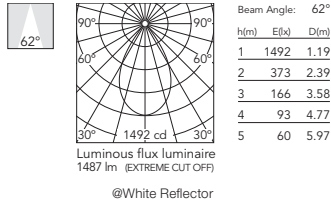

4000K - CRI 90

Trim

- E I 03.6810.3BA
- E I 03.6810.3CA
- E I Dali Version/1-10V
- E I 03.6810.3BADA
- E I 03.6810.3CADA

No Trim

- E I 03.6810.1BA
- E I 03.6810.1CA
- E I Dali Version/1-10V
- E I 03.6810.1BADA
- E I 03.6810.1CADA

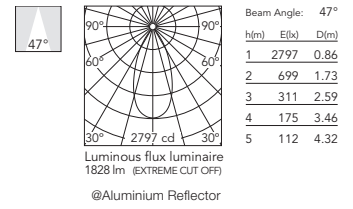
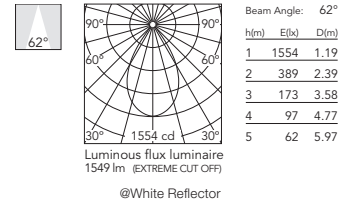

3000K - CRI 80

Trim

- E I 03.6809.3BA
- E I 03.6809.3CA
- E I Dali Version/1-10V
- E I 03.6809.3BADA
- E I 03.6809.3CADA

No Trim

- E I 03.6809.1BA
- E I 03.6809.1CA
- E I Dali Version/1-10V
- E I 03.6809.1BADA
- E I 03.6809.1CADA

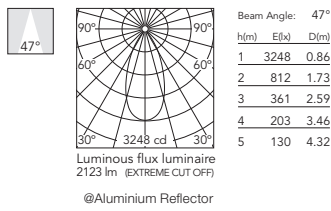
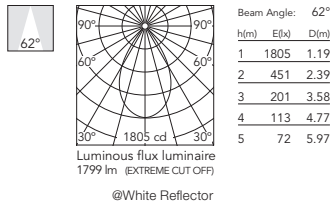

LIGHT SUPPLY

Light Supply Adjustable Trim

Light Source: LED Array High Performances 30,1W - 2811 lm - 3000K/CRI 90 / 30,1W - 2929 lm - 4000K/CRI 90

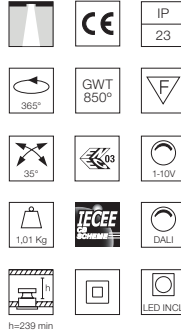
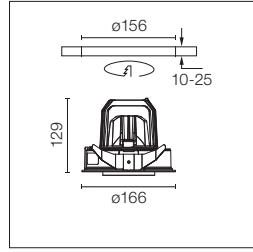

LED Einbauleuchte. Fernnetzgerät mit 220/240V im Lieferumfang enthalten.

Recessed luminaire with LED light source. Remote 220/240V power supply included.

Light Supply Adjustable No Trim

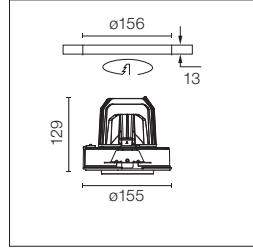

Vormontagerahmen oder Soft Architecture Montageplatte für No Trim Ausführung. Muss separat bestellt werden.

Pre-installation frame or Soft Architecture installation plate for No Trim installation. To be ordered separately.

3000K - CRI 90 Trim

- 03.6806.40A
- 03.6806.14A
- Dali Version/1-10V
- 03.6806.40ADA
- 03.6806.14ADA
- No Trim**
- 03.6821.40A
- 03.6821.14A
- Dali Version/1-10V
- 03.6821.40ADA
- 03.6821.14ADA

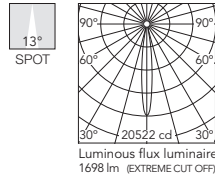

h(m)	Et(x)	D(m)
1	20522	0.23
2	5131	0.46
3	2280	0.69
4	1283	0.92
5	821	1.15

4000K - CRI 90 Trim

- 03.6803.40A
- 03.6803.14A
- Dali Version/1-10V
- 03.6803.40ADA
- 03.6803.14ADA
- No Trim**
- 03.6818.40A
- 03.6818.14A
- Dali Version/1-10V
- 03.6818.40ADA
- 03.6818.14ADA

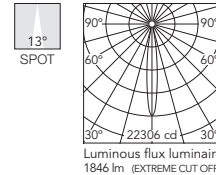

h(m)	Et(x)	D(m)
1	22306	0.23
2	5576	0.46
3	2478	0.69
4	1394	0.92
5	892	1.15

3000K - CRI 90 Trim

- 03.6807.40A
- 03.6807.14A
- Dali Version/1-10V
- 03.6807.40ADA
- 03.6807.14ADA
- No Trim**
- 03.6822.40A
- 03.6822.14A
- Dali Version/1-10V
- 03.6822.40ADA
- 03.6822.14ADA

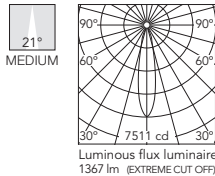

h(m)	Et(x)	D(m)
1	7511	0.37
2	1878	0.75
3	835	1.12
4	469	1.49
5	300	1.87

4000K - CRI 90 Trim

- 03.6804.40A
- 03.6804.14A
- Dali Version/1-10V
- 03.6804.40ADA
- 03.6804.14ADA
- No Trim**
- 03.6819.40A
- 03.6819.14A
- Dali Version/1-10V
- 03.6819.40ADA
- 03.6819.14ADA

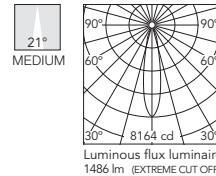

h(m)	Et(x)	D(m)
1	8164	0.37
2	2041	0.75
3	907	1.12
4	510	1.49
5	327	1.87

3000K - CRI 90 Trim

- 03.6808.40A
- 03.6808.14A
- Dali Version/1-10V
- 03.6808.40ADA
- 03.6808.14ADA
- No Trim**
- 03.6823.40A
- 03.6823.14A
- Dali Version/1-10V
- 03.6823.40ADA
- 03.6823.14ADA

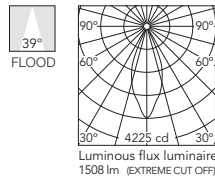

h(m)	Et(x)	D(m)
1	4225	0.71
2	1056	1.42
3	469	2.14
4	264	2.85
5	169	3.56

4000K - CRI 90 Trim

- 03.6805.40A
- 03.6805.14A
- Dali Version/1-10V
- 03.6805.40ADA
- 03.6805.14ADA
- No Trim**
- 03.6820.40A
- 03.6820.14A
- Dali Version/1-10V
- 03.6820.40ADA
- 03.6820.14ADA

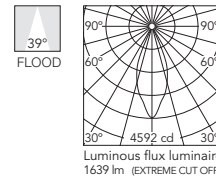

h(m)	Et(x)	D(m)
1	4592	0.71
2	1148	1.42
3	510	2.14
4	287	2.85
5	184	3.56

LIGHT SUPPLY

Light Supply Adjustable Trim

Light Source: LED Array High Performances 30,1W - 3402 lm - 3000K CRI 80

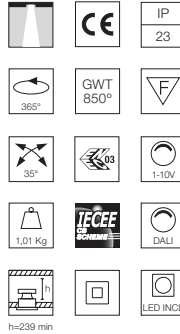
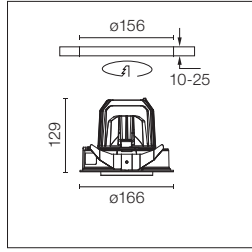

LED Einbauleuchte. Fernnetzgerät mit 220/240V im Lieferumfang enthalten.

Recessed luminaire with LED light source. Remote 220/240V power supply included.

Light Supply Adjustable No Trim

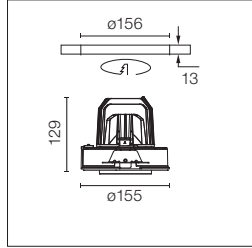

Vormontagerahmen oder Soft Architecture Montageplatte für No Trim Ausführung. Muss separat bestellt werden.

Pre-installation frame or Soft Architecture installation plate for No Trim installation. To be ordered separately.

3000K - CRI 80 Trim

- 03.6800.40A
- 03.6800.14A
- Dali Version/1-10V
- 03.6800.40ADA
- 03.6800.14ADA
- No Trim**
- 03.6815.40A
- 03.6815.14A
- Dali Version/1-10V
- 03.6815.40ADA
- 03.6815.14ADA

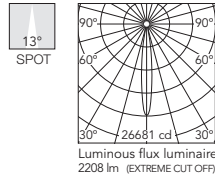

Beam Angle: 13°

h(m)	E(lx)	D(m)
1	26681	0.23
2	6670	0.46
3	2965	0.69
4	1668	0.92
5	1067	1.15

Luminous flux luminaire 2208 lm (EXTREME CUT OFF)

3000K - CRI 80 Trim

- 03.6801.40A
- 03.6801.14A
- Dali Version/1-10V
- 03.6801.40ADA
- 03.6801.14ADA
- No Trim**
- 03.6816.40A
- 03.6816.14A
- Dali Version/1-10V
- 03.6816.40ADA
- 03.6816.14ADA

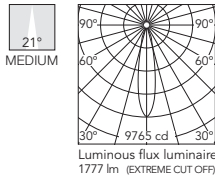

Beam Angle: 21°

h(m)	E(lx)	D(m)
1	9765	0.37
2	2441	0.75
3	1085	1.12
4	610	1.49
5	391	1.87

Luminous flux luminaire 1777 lm (EXTREME CUT OFF)

3000K - CRI 80 Trim

- 03.6802.40A
- 03.6802.14A
- Dali Version/1-10V
- 03.6802.40ADA
- 03.6802.14ADA
- No Trim**
- 03.6817.40A
- 03.6817.14A
- Dali Version/1-10V
- 03.6817.40ADA
- 03.6817.14ADA

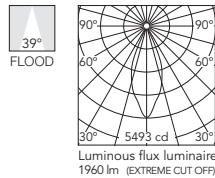

Beam Angle: 39°

h(m)	E(lx)	D(m)
1	5493	0.71
2	1373	1.42
3	610	2.14
4	343	2.85
5	220	3.56

Luminous flux luminaire 1960 lm (EXTREME CUT OFF)

LIGHT SUPPLY

Light Supply Wall-Washer Trim

Light Source: LED Array High Performances 33,2W - 3770 lm - 3000K/CRI 80 / 33,2W - 3116 lm - 3000K/CRI 90 / 33,2W - 3246 lm - 4000K/CRI 90

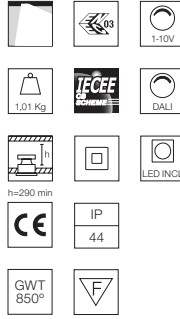
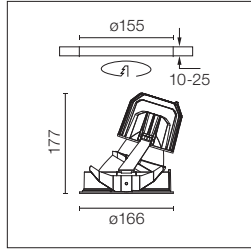

LED Einbauleuchte. Fernnetzgerät mit 220/240V im Lieferumfang enthalten.

Recessed luminaire with LED light source. Remote 220/240V power supply included.

E= Außenfarbe
I= Innenfarbe.

E= External Finish
I= Internal Finish.

Light Supply Wall-Washer No Trim

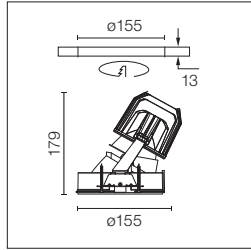

Vorinstallationsrahmen. Muss separat bestellt werden.

Pre-installation frame. To be ordered separately.

3000K - CRI 90

Trim

- E I 03.6814.3BA
- E I 03.6814.3CA
- E I Dali Version/1-10V
- E I 03.6814.3BADA
- E I 03.6814.3CADA

- E I 03.6814.1BA
- E I 03.6814.1CA
- E I Dali Version/1-10V
- E I 03.6814.1BADA
- E I 03.6814.1CADA

No Trim

- 03.6829.40A
- 03.6829.06A
- Dali Version/1-10V
- 03.6829.40ADA
- 03.6829.06ADA

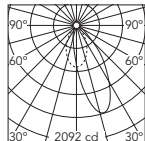

Beam Angle: 36°

h(m)	E(lx)	D(m)
1	2092	0.74
2	523	1.48
3	232	2.22
4	131	2.95
5	84	3.69

Luminous flux luminaire
1771 lm (EXTREME CUT OFF)
@White Reflector

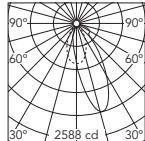

Beam Angle: 34°

h(m)	E(lx)	D(m)
1	2588	0.67
2	647	1.35
3	288	2.02
4	162	2.69
5	104	3.37

Luminous flux luminaire
1909 lm (EXTREME CUT OFF)
@Aluminium Reflector

4000K - CRI 90

Trim

- E I 03.6813.3BA
- E I 03.6813.3CA
- E I Dali Version/1-10V
- E I 03.6813.3BADA
- E I 03.6813.3CADA

- E I 03.6813.1BA
- E I 03.6813.1CA
- E I Dali Version/1-10V
- E I 03.6813.1BADA
- E I 03.6813.1CADA

No Trim

- 03.6828.40A
- 03.6828.06A
- Dali Version/1-10V
- 03.6828.40ADA
- 03.6828.06ADA

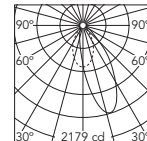

Beam Angle: 36°

h(m)	E(lx)	D(m)
1	2179	0.74
2	545	1.48
3	242	2.22
4	136	2.95
5	87	3.69

Luminous flux luminaire
1845 lm (EXTREME CUT OFF)
@White Reflector

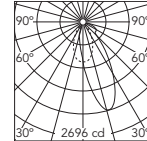

Beam Angle: 34°

h(m)	E(lx)	D(m)
1	2696	0.67
2	674	1.35
3	300	2.02
4	168	2.69
5	108	3.37

Luminous flux luminaire
1989 lm (EXTREME CUT OFF)
@Aluminium Reflector

3000K - CRI 80

Trim

- E I 03.6812.3BA
- E I 03.6812.3CA
- E I Dali Version/1-10V
- E I 03.6812.3BADA
- E I 03.6812.3CADA

- E I 03.6812.1BA
- E I 03.6812.1CA
- E I Dali Version/1-10V
- E I 03.6812.1BADA
- E I 03.6812.1CADA

No Trim

- 03.6827.40A
- 03.6827.06A
- Dali Version/1-10V
- 03.6827.40ADA
- 03.6827.06ADA

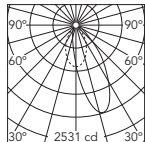

Beam Angle: 36°

h(m)	E(lx)	D(m)
1	2531	0.74
2	633	1.48
3	281	2.22
4	158	2.95
5	101	3.69

Luminous flux luminaire
2142 lm (EXTREME CUT OFF)
@White Reflector

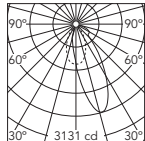

Beam Angle: 34°

h(m)	E(lx)	D(m)
1	3131	0.67
2	783	1.35
3	348	2.02
4	196	2.69
5	125	3.37

Luminous flux luminaire
2310 lm (EXTREME CUT OFF)
@Aluminium Reflector

LIGHT SUPPLY

Zubehör / Accessories

Vormontagerahmen.

Pre-installation frame.



Adjustable No Trim
08.8119.00



Fixed No Trim
08.8359.00



Wall-Washer No Trim
08.8137.00

Soft Architecture Montageplatte für Einbau in Gipskartonflächen.

Soft Architecture installation plate for integration in plasterboard.

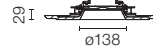

Adjustable No Trim
SA.6600.1

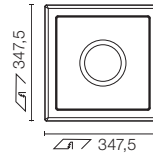

For Phosphor LED

Austauschreflektor für verstellbare Lichtquelle.

Light Supply Adjustable spare reflector.



Spot
08.8413.00
Medium
08.8414.00
Flood
08.8415.00

LIGHT SUPPLY

Zubehör / Accessories

For LED Array

Austauschreflektor für verstellbare
Lichtquelle.

Light Supply Adjustable spare
reflector.



Spot
08.8450.00
Medium
08.8451.00
Flood
08.8452.00

Querabschirmung.

Screening crosspiece.



08.8242.14

Elliptische linse.

Elliptical lens.



08.8118.68

Honeycomb.

Honeycomb.



Kleine Zellen/Small Cells
08.8049.14



Große Zellen/Big Cells
08.8377.14

Hoch effizienter zylinder.

Highly-efficient cylinder.



08.8453.40
08.8453.14

PURE DOWNLIGHT

DESIGNED BY KNUD HOLSCHER

TRIM / NO TRIM



LIGHT SOURCE
PHOSPHOR
LED
13,6W
1490 lm
3000K/CRI 80
11,9W
1057 lm
3000K/CRI 98

LIGHT SOURCE
POWER LED
15,7W
1400 lm
2700K/CRI 80
3000K/CRI 80

LIGHT SOURCE
LED
QR-CBC 51
GX5.3

□ 30 Weiss/RAL 9001
30 White

■ 02 Grau/RAL 9006
02 Grey

■ 14 Schwarz/RAL 9005
14 Black

Pure Downlight Trim



Pure Downlight No Trim



Drehbar um 360° und schwenkbar 60°.
Can be rotated 360° and swivelled 60°.

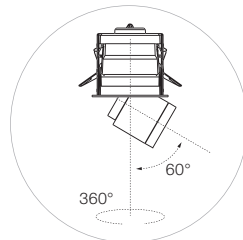

PURE DOWNLIGHT

Produktbeschreibung

LED-Inneneinbauleuchte, auch für LED-Retrofitlampen erhältlich. Leuchtmittelhalterung aus Keramik oder selbstlöschendem Technopolymer, mit einpoliger, teflon-isolierter Zuleitung mit doppelter, transparenter Isolierung. Der Leuchtenkörper besteht aus einem lichtstreuenden Element aus Aluminium, das auf die Leuchtmittelhalterung aufgesetzt ist, aus einem Vorsatzhaltering aus schwarzem, thermoplastischen Material und einem 4 mm starkem Hartglas. Leuchtenkörper, Schließkappe und ausrichtbare Leuchtenhalterung sind aus Aluminiumlegierungsdruckguss, weiss, grau oder schwarz pulverlackiert.

Reflektoren

Alle Optiken sind aus hochglanzpoliertem Reinaluminium.
Rund symmetrisch strahlend für Spot (15°) oder Wide Flood (51°).

Betriebsgerät

Vorverkabelung inbegriffen; Ausgestattet für externes Betriebsgerät.
Schnellanschluss an das Betriebsgerät für Entladungslampen mit Wieland-Steckverbinder.

Zubehör

- Elliptische Lichtstreulinse aus 4 mm starkem gehärtetem Glas.
- Blendschutzgitter aus Aluminiumzellen mit schwarzer Beschichtung.
- Farbfilter.

Zusatzinformationen

Ausrichtbarkeit um 60° auf der Vertikalachse und um 360° auf der Horizontalachse.
Schutzgrad IP20.
Schutzklasse I, II, III je nach Modell.
Auf normal entflammaren Oberflächen einsetzbar.

Qualitätszeichen

Das Gerät entspricht der europäischen technischen Norm EN60598-1 und den entsprechenden Zusatzregelungen.

Description

Recessed LED luminaire for indoor application, also available for LED retrofit lamps. Self-extinguishing ceramic or engineering plastic lamp holders, with single-pole, transparent electric wires with double Teflon insulation. Aluminum body, placed above the lamp holder, black thermoplastic and 4 mm tempered glass screen-support ring. Die-cast aluminum alloy body, cover and adjustable lamp support, powder-coated white, grey or black.

Reflectors

All super pure aluminum with specular finish.
Circular rotosymmetrical from 15° spot to 51° wide flood.

Power Supply

Pre-wiring included; ready for remote power supply.
Wieland connectors used for discharge control gear providing quick installation time.

Accessories

- 4 mm tempered glass elliptical distribution lens.
- Anti-glare grid in aluminium cells with black liquid paint finish.
- Chromatic filters.

Additional Information

0° - 360° horizontal rotation, 0° - 60° vertical rotation.
IP20 protection grade.
Insulation class I, II, III depending on the versions.
Suitable for installation on normally inflammable surfaces.

Standard Compliance and Quality Marks

EN60598-1 European Technical Standards and any subsequent additions.

PURE DOWNLIGHT

Pure Downlight Trim

Light Source: Phosphor LED 13,6W - 1490 lm - 3000K/CRI 80 / 11,9W - 1057 lm 3000K/CRI 98

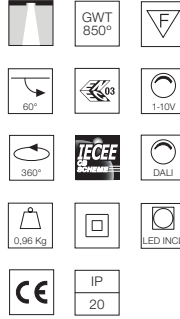
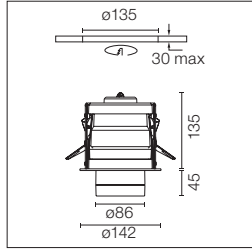

LED Einbauleuchte. Elektronischer Ferntransformator 220/240V inbegriffen.

Recessed luminaire with LED light source. Remote electronic transformer 220/240V included.

Der Rahmen für das Einbaugehäuse ist getrennt zu bestellen.

Installation frame must be ordered separately.

Pure Downlight No Trim

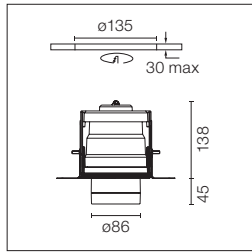

3000K - CRI 80

- Non Dimmable
- 09.1635.30C
 - 09.1635.02C
 - 09.1635.14C
- Dali Version
- 09.1635.30CDA
 - 09.1635.02CDA
 - 09.1635.14CDA
- 1-10V
- 09.1635.30C1V
 - 09.1635.02C1V
 - 09.1635.14C1V

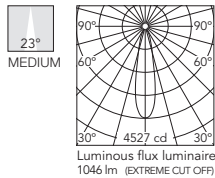

Beam Angle: 23°

h(m)	E(lx)	D(m)
1	4527	0.40
2	1132	0.81
3	503	1.21
4	283	1.62
5	181	2.02

3000K - CRI 98

- Non Dimmable
- 09.1630.30C
 - 09.1630.02C
 - 09.1630.14C
- Dali Version
- 09.1630.30CDA
 - 09.1630.02CDA
 - 09.1630.14CDA
- 1-10V
- 09.1630.30C1V
 - 09.1630.02C1V
 - 09.1630.14C1V

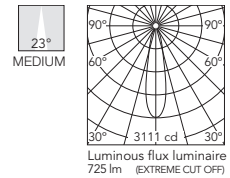

Beam Angle: 23°

h(m)	E(lx)	D(m)
1	3111	0.41
2	778	0.82
3	346	1.22
4	194	1.63
5	124	2.04

3000K - CRI 80

- Non Dimmable
- 09.1636.30C
 - 09.1636.02C
 - 09.1636.14C
- Dali Version
- 09.1636.30CDA
 - 09.1636.02CDA
 - 09.1636.14CDA
- 1-10V
- 09.1636.30C1V
 - 09.1636.02C1V
 - 09.1636.14C1V

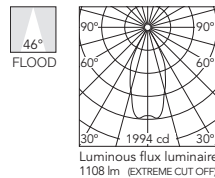

Beam Angle: 46°

h(m)	E(lx)	D(m)
1	1994	0.84
2	499	1.68
3	222	2.52
4	125	3.36
5	80	4.19

3000K - CRI 98

- Non Dimmable
- 09.1631.30C
 - 09.1631.02C
 - 09.1631.14C
- Dali Version
- 09.1631.30CDA
 - 09.1631.02CDA
 - 09.1631.14CDA
- 1-10V
- 09.1631.30C1V
 - 09.1631.02C1V
 - 09.1631.14C1V

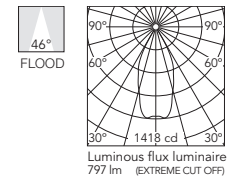

Beam Angle: 46°

h(m)	E(lx)	D(m)
1	1418	0.84
2	355	1.69
3	158	2.53
4	89	3.37
5	57	4.21

3000K - CRI 80

- Non Dimmable
- 09.1637.30C
 - 09.1637.02C
 - 09.1637.14C
- Dali Version
- 09.1637.30CDA
 - 09.1637.02CDA
 - 09.1637.14CDA
- 1-10V
- 09.1637.30C1V
 - 09.1637.02C1V
 - 09.1637.14C1V

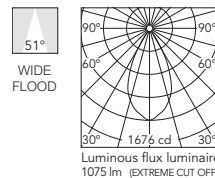

Beam Angle: 51°

h(m)	E(lx)	D(m)
1	1676	0.95
2	419	1.89
3	186	2.84
4	105	3.79
5	67	4.74

3000K - CRI 98

- Non Dimmable
- 09.1632.30C
 - 09.1632.02C
 - 09.1632.14C
- Dali Version
- 09.1632.30CDA
 - 09.1632.02CDA
 - 09.1632.14CDA
- 1-10V
- 09.1632.30C1V
 - 09.1632.02C1V
 - 09.1632.14C1V

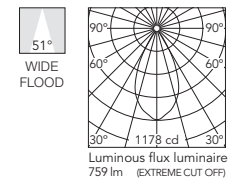

Beam Angle: 51°

h(m)	E(lx)	D(m)
1	1178	0.95
2	295	1.91
3	131	2.86
4	74	3.82
5	47	4.77

PURE DOWNLIGHT

Pure Downlight Trim

Light Source: Power LED DC 700 mA - 15,7W - 1400 lm - 2700K/CRI 80 / 15,7W - 1400 lm - 3000K/CRI80

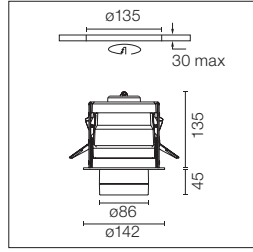

LED Einbauleuchte. Ohne Netzgerät. Recessed luminaire with LED light source. Power supply not included.

Der Rahmen für das Einbaugehäuse ist getrennt zu bestellen. Installation frame must be ordered separately.

Empfohlene Netzgeräte / Recommended power supply*:

Non Dimmable	60.9312
Dimmable 1-10V	60.8533
Dimmable Dali	60.8847
Mains Dimming	60.8534

* Siehe Treiberkapitel / Refer to the Drivers chapter

Pure Downlight No Trim

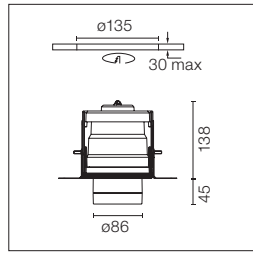

2700K - CRI 80
 09.1640.30B
 09.1640.02B
 09.1640.14B

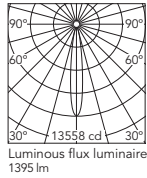

Beam Angle: 15°

h(m)	Et(k)	D(m)
1	13558	0.26
2	3390	0.52
3	1506	0.78
4	847	1.04
5	542	1.30

Luminous flux luminaire
1395 lm

3000K - CRI 80
 09.1645.30B
 09.1645.02B
 09.1645.14B

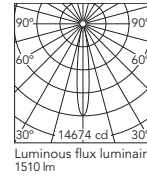

Beam Angle: 15°

h(m)	Et(k)	D(m)
1	14674	0.26
2	3668	0.52
3	1630	0.78
4	917	1.04
5	587	1.30

Luminous flux luminaire
1510 lm

2700K - CRI 80
 09.1641.30B
 09.1641.02B
 09.1641.14B

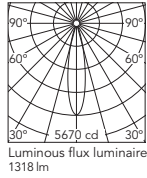

Beam Angle: 22°

h(m)	Et(k)	D(m)
1	5670	0.38
2	1417	0.77
3	630	1.15
4	354	1.54
5	227	1.92

Luminous flux luminaire
1318 lm

3000K - CRI 80
 09.1646.30B
 09.1646.02B
 09.1646.14B

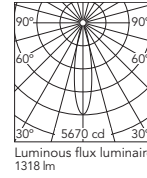

Beam Angle: 22°

h(m)	Et(k)	D(m)
1	5670	0.38
2	1417	0.77
3	630	1.15
4	354	1.54
5	227	1.92

Luminous flux luminaire
1318 lm

2700K - CRI 80
 09.1642.30B
 09.1642.02B
 09.1642.14B

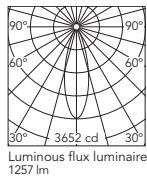

Beam Angle: 30°

h(m)	Et(k)	D(m)
1	3652	0.54
2	913	1.09
3	406	1.63
4	228	2.18
5	146	2.72

Luminous flux luminaire
1257 lm

3000K - CRI 80
 09.1647.30B
 09.1647.02B
 09.1647.14B

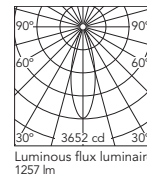

Beam Angle: 30°

h(m)	Et(k)	D(m)
1	3652	0.54
2	913	1.09
3	406	1.63
4	228	2.18
5	146	2.72

Luminous flux luminaire
1257 lm

PURE DOWNLIGHT

Pure Downlight Trim

Light Source: LED QR-CBC 51 GX5.3

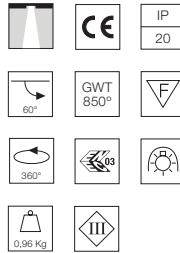
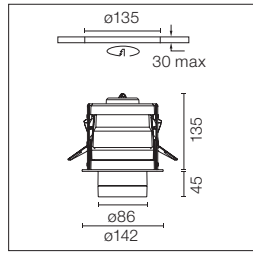

Einbauleuchte für 12V Lampe.
Separater Transformator nicht
inbegriffen.

Recessed 12V lamp luminaire.
Remote transformer not included.

Der Rahmen für das Einbaugehäuse
ist getrennt zu bestellen.

Installation frame must be ordered
separately.

Pure Downlight No Trim

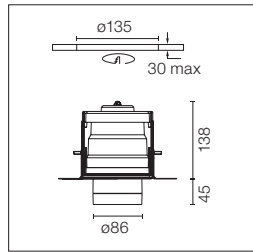

- 09.1600.30
- 09.1600.02
- 09.1600.14

Zubehör / Accessories

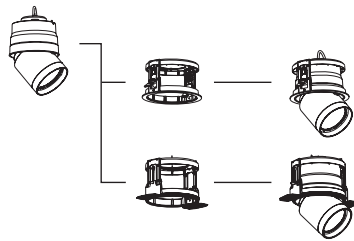

Trim

Beispiel / Example:
09.1630.30 + 08.8149.30 = TRIM

No Trim

Beispiel / Example:
09.1630.30 + 08.8152.00 = NO TRIM

Rahmen für Einbaugehäuse.

Installation frame.



- Pure Downlight Trim
- 08.8149.30
- 08.8149.02
- 08.8149.14

Pure Downlight No Trim
08.8152.00

PURE DOWNLIGHT

Zubehör / Accessories

Die elliptischen Linsen, der Abblenderaster und die verschiedenen Filter sind nur mit dem Dichtungsring in dem der Leuchte entsprechenden Durchmesser zu verwenden.

Elliptical lens, honeycomb filter, different filters and flood lens, must always be used with the holding ring using the correct diameter.

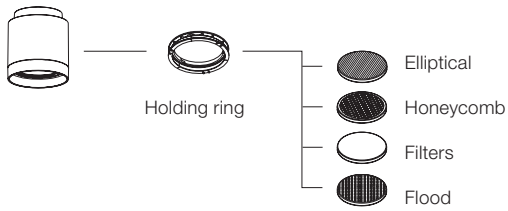

Haltering
Holding ring

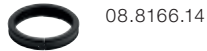

Elliptische linse
Elliptical lens



08.8163.68

Floodlinse
Flood lens



08.8175.68

Honeycomb
Honeycomb



08.8169.14

Blauer filter
Blue filter



08.8160.64.OD

Hellblauer filter
Sky blue filter



08.8160.65.OD

Amber filter
Amber filter



08.8160.66.OD

Roter filter
Red filter



08.8160.67.OD

U.V. filter
U.V. filter



08.8160.98.OD

I.R. filter
I.R. filter



08.8160.68

Hot light
Hot light



08.8160.69

Cold light
Cold light



08.8160.CL

Daylight
Daylight



08.8160.DL

Neodimium
Neodimium



08.8160.ND

Außenring PRO für Pure
Downlight 1. Nur für
halogenlampen, version LED
auf anfrage.



08.8232.30
08.8232.02
08.8232.14

Pure Downlight 1 External
ring accessory PRO. Only for
halogen lamps, consult cor
LED version.

COMPASS

DESIGNED BY FLOS ARCHITECTURAL

ADJUSTABLE
Ø90



LIGHT SOURCE
LED
PAR 16
GZ10

LIGHT SOURCE
LED
QR-CBC 51
GX5.3

OPAL
Ø90



LIGHT SOURCE
LED
QT-12
GY6.35

FIXED
Ø90



LIGHT SOURCE
LED
QR-CBC 51
GX5.3

IP65
Ø95



LIGHT SOURCE
LED
QR-CBC 51
GX5.3

ADJUSTABLE
Ø162



LIGHT SOURCE
LED
QR-111
G53

□ 30 Mattweiss/RAL 9001
30 Matt White

■ 02 Grau/RAL 9006
02 Grey

■ 14 Mattschwarz /RAL 9005
14 Matt Black



Compass Ø90

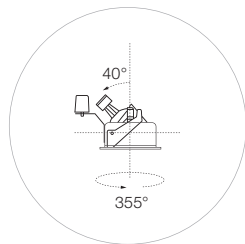

Compass Ø162

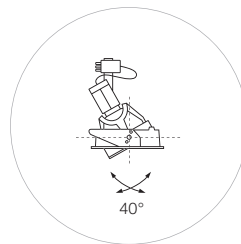

Produktbeschreibung

Strahler für LED retrofit Lampen.

- Feststehender Strahler:

Einbaukörper aus schwarz lackiertem Metall. Schließring aus pulverlackiertem Aluminiumlegierungsdruckguss. Lampenhalterung mit lichtstreuendem Element aus Aluminiumdruckguss. Entspiegelungsring aus schwarzem, thermoplastischem Material. 4 mm starkes, gehärtetes Schutzglas. Befestigungssystem mit rostfreien Stahlbügeln.

- Schwenkbarer Strahler:

Optikgehäuse aus pulverlackiertem Aluminiumspritzguss. Lampenhalterung mit Lichtstreuerelement aus schwarz pulverlackiertem Aluminiumdruckguss. Einbauring und Abschirmring aus thermoplastischem Material; Entspiegelungsring aus schwarz pulverlackiertem Aluminiumdruckguss. 4 mm starkes, gehärtetes Schutzglas. Befestigungssystem mit rostfreien Stahlbügeln.

Zubehör

- Abschirmzylinder aus schwarzem Teflon mit Befestigung auf rostfreiem Stahlsockel.

- Zylinderblende mit drehbarem Gelenkstift aus schwarzem, thermoplastischem Material.

- Elliptische Lichtstreuulinse aus 4 mm starkem Hartglas.

- Farbfilter.

Zusatzinformationen

Das kardanische Ausrichtsystem erlaubt einen Schwenkbereich von 40° in alle Richtungen.

Schutzgrad IP23, IP43, IP44, IP65 je nach Modell.

Schutzklasse II, III je nach Modell.

Auf normal entflammaren Oberflächen einsetzbar.

Qualitätszeichen

Das Gerät entspricht der europäischen technischen Norm EN60598-1 und den entsprechenden Zusatzregelungen.

Description

Luminaire for LED retrofit lamps.

- Fixed:

Recessed body in black-painted metal. Die-cast aluminum alloy, powder-coated closing ring. Die-cast aluminum lamp support with heat dissipating element. Black thermoplastic anti-glare ring, 4 mm tempered glass cover. Stainless steel fixing brackets.

- Adjustable:

Injection-moulded aluminum reflector body with powder-coated finish. Lamp support with die-cast aluminum, black powder-coated heat dissipating element. Thermoplastic recessed ring and screening ring; die-cast aluminum, black powder-coated anti-glare ring. 4 mm tempered glass cover. Stainless steel fixing brackets.

Accessories

- Black Teflon screening cylinders on stainless steel support.

- Screening cylinder with black thermoplastic rotating pin.

- 4 mm tempered glass elliptical distribution lens.

- Chromatic filters.

Additional Information

Compass-type adjustment system, for 0° - 40° adjustment in all directions.

IP23, IP43, IP44, IP65 protection grade depending on the versions.

Insulation class II, III depending on the versions.

Suitable for installation on normally inflammable surfaces.

Standard Compliance and Quality Marks

EN60598-1 European Technical Standards and any subsequent additions.

COMPASS

Compass Adjustable Ø90

Light Source: LED PAR 16 GZ10

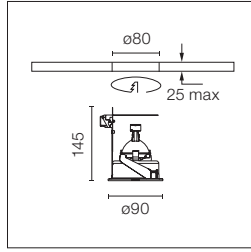

Einbauleuchte für Netzspannung für LED-Retrofit-Lampe.
Leuchten mit einem Blendschutzwinkel von mehr als 25°, gemäss CIBSE LG3 (L<200 cd/m²).

Recessed luminaire with main voltage source for LED Retrofit lamp.
Angle greater than 25°, as per CIBSE LG3 (L<200 cd/m²).

- 03.3506.30
- 03.3506.02
- 03.3506.14

Compass Opal C Ø90

Light Source: LED QT-12 GY6.35

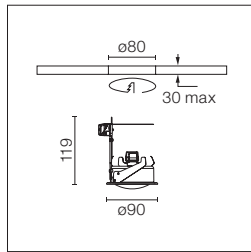

Einbauleuchte für 12 V LED-Retrofit-Lampe. Separater Transformator nicht inbegriffen.

Recessed luminaire for 12V LED Retrofit lamp. Remote transformer not included.

- 03.3539.30
- 03.3539.02
- 03.3539.14

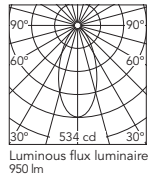

Beam Angle: 49°

h(m)	E(lx)	D(m)
1	534	0.90
2	134	1.80
3	59	2.71
4	33	3.61
5	21	4.51

Compass Opal P Ø90

Light Source: LED QT-12 GY6.35

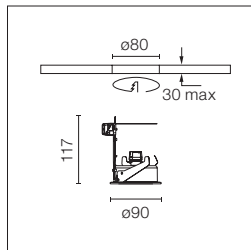

Einbauleuchte für 12 V LED-Retrofit-Lampe. Separater Transformator nicht inbegriffen.

Recessed luminaire for 12V LED Retrofit lamp. Remote transformer not included.

- 03.3538.30
- 03.3538.02
- 03.3538.14

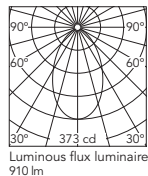

Beam Angle: 64°

h(m)	E(lx)	D(m)
1	373	1.25
2	93	2.50
3	41	3.75
4	23	5.00
5	15	6.24

COMPASS

Compass Adjustable Ø90

Light Source: LED QR-CBC 51 GX5.3

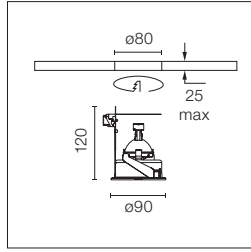

Einbauleuchte für 12 V LED-Retrofit-Lampe. Separater Transformator nicht inbegriffen.

Recessed luminaire for 12V LED Retrofit lamp. Remote transformer not included.

Leuchten mit einem Blendschutzwinkel von mehr als 25°, gemäss CIBSE LG3 ($L < 200 \text{ cd/m}^2$).

Angle greater than 25°, as per CIBSE LG3 ($L < 200 \text{ cd/m}^2$).

- 03.3505.30
- 03.3505.02
- 03.3505.14

Compass Fixed Ø90

Light Source: LED QR-CBC 51 GX5.3

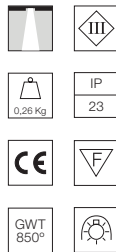
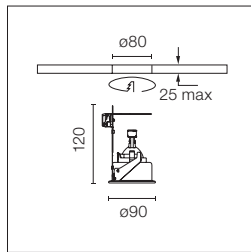

Einbauleuchte für 12 V LED-Retrofit-Lampe. Separater Transformator nicht inbegriffen.

Recessed luminaire for 12V LED Retrofit lamp. Remote transformer not included.

Leuchten mit einem Blendschutzwinkel von mehr als 25°, gemäss CIBSE LG3 ($L < 200 \text{ cd/m}^2$).

Angle greater than 25°, as per CIBSE LG3 ($L < 200 \text{ cd/m}^2$).

- 03.3507.30
- 03.3507.02
- 03.3507.14

Compass Adjustable Ø90

Light Source: LED QR-CBC 51 GX5.3

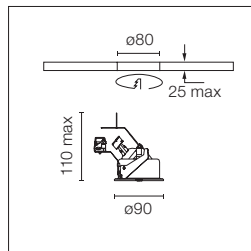

Einbauleuchte für 12 V LED-Retrofit-Lampe. Separater Transformator nicht inbegriffen.

Recessed luminaire for 12V LED Retrofit lamp. Remote transformer not included.

- 03.3508.30
- 03.3508.02
- 03.3508.14

COMPASS

Compass IP65 Ø95

Light Source: LED QR-CBC 51 GX5.3

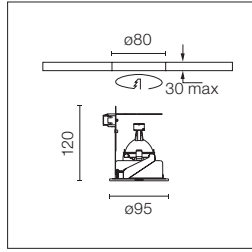

Einbauleuchte für 12 V LED-Retrofit-Lampe. Separater Transformator nicht inbegriffen.

Recessed luminaire for 12V LED Retrofit lamp. Remote transformer not included.



- 03.3502.30
- 03.3502.02
- 03.3502.14

Compass Adjustable Ø162

Light Source: LED QR-111 G53

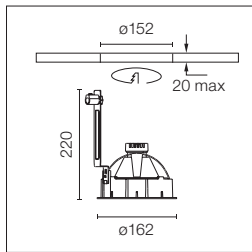

Einbauleuchte für 12 V LED-Retrofit-Lampe. Separater Transformator nicht inbegriffen.

Recessed luminaire for 12V LED Retrofit lamp. Remote transformer not included.







- 03.3520.30
- 03.3520.02
- 03.3520.14

COMPASS

Zubehör / Accessories

Refs: 3502 / 3505 / 3506 / 3507 / 3508

Compas Ø90/Ø95

Elliptische linse Elliptical lens		08.8041.68
Blauer filter Blue filter		08.8042.64.OD
Hellblauer filter Sky blue filter		08.8042.65.OD
Amber filter Amber filter		08.8042.66.OD
Roter filter Red filter		08.8042.67.OD
U.V. filter U.V. filter		08.8042.98.OD
I.R. Filter I.R. Filter		08.8042.68
Hot light Hot light		08.8042.69
Cold light Cold light		08.8042.CL
Daylight Daylight		08.8042.DL
Neodimium Neodimium		08.8042.ND

Compas Ø162

Querabschirmung Screening crosspiece		08.8034.14
Elliptische linse Elliptical lens		08.8930.68
Blendschutzgitter Anti-glare grid		08.8036.14
Floodlinse Flood lens		08.8931.68
Blauer filter Blue filter		08.8932.64.OD
Hellblauer filter Sky blue filter		08.8932.65.OD
Amber filter Amber filter		08.8932.66.OD
Roter filter Red filter		08.8932.67.OD
U.V. filter U.V. filter		08.8932.98.OD
I.R. filter I.R. filter		08.8933.68
Hot light Hot light		08.8932.69
Cold light Cold light		08.8932.CL
Daylight Daylight		08.8932.DL
Neodimium Neodimium		08.8932.ND

ANTHONY DOWNLIGHT

DESIGNED BY ANTONIO CITTERIO



LIGHT SOURCE
POWER LED
10W
905 lm
2700K/CRI 90
975 lm
3000K/CRI 90

□ 40 Weiss
40 White

■ 05 Chrom
05 Chrome

■ 14 Schwarz
14 Black



Produktbeschreibung

Downlight, ein Design von Antonio Citterio für den Einbau in Decken, mit LED-Stromtechnik der neuesten Generation. Die Leuchten sind mit einer Drehvorrichtung (360°) und Wippvorrichtung (40°) versehen und vielseitig einsetzbar; dies erlaubt ihre genaue Ausrichtung auf zu beleuchtende Objekte. Die erhältlichen Ausführungen bieten Leuchtköpfe mit Dekoration in Weiß, Chrom und Schwarz, während der Einbaukörper immer in weiß angeboten wird. Diese neue Ausführung verfügt über zusätzliche wählbare Honeycomb-, Elypse- und Flood-Filter.

Betriebsgerät

Stromanschluss für Gleitstrom ist nicht eingeschlossen. Verfügbar in nicht regulierbaren Ausführungen und DALI-Ausführung sowohl für Netzspannungen von 110Vac als auch 230Vac.

Zusatzinformationen

Schutzgrad IP20.
Schutzklasse III.

Qualitätszeichen

Das Gerät entspricht der europäischen technischen Norm EN60598-1 und den entsprechenden Zusatzregelungen.

Description

Downlight designed by Antonio Citterio for installation in ceilings, with state-of-the-art power LED technology. Light fitting with highly versatile revolving (360°) and tilt (40°) system, enabling it to be accurately oriented towards illuminated objects. The finishes available have the light fitting heads in white, chrome and black, while the embedded body is always in white. This new version has honeycomb, elliptical and flood options.

Power Supply

Direct current power source not included Available in non-adjustable versions and DALI for network voltages 110Vac and 230Vac.

Additional Information

IP20 protection grade.
Insulation class III.

Standard Compliance and Quality Marks

EN60598-1 European Technical Standards and any subsequent additions.

ANTHONY DOWNLIGHT

Anthony Downlight

Light Source: Power LED DC 900mA - 10W - 905 lm - 2700K/CRI 90 / 10W - 975 lm - 3000K/CRI 90

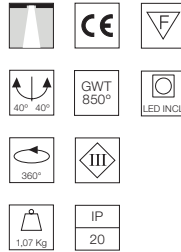
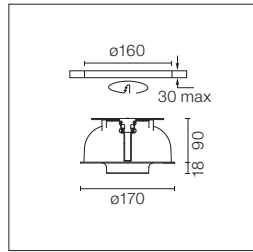

Hochleistungseinbauelement für LED-Lampe. Fernnetzgerät 220-240V nicht inbegriffen.

High-performance embedded light fixture for LED light source. Remote 220-240V power supply not included.

Einbaukörper weiß für alle Ausführungen; auf Anfrage Ausführung in schwarz erhältlich.

Standard trim cove in white for all finishes; black finish available under request.

Empfohlene Netzgeräte / Recommended power supply*:

Non Dimmable 110-240V (900mA)	60.9233
Dimmable Dali 2 220-240V	60.9186
Dimmable Dali/1-10V/Push	60.8530
Dimmable 0-10V 220-240V	60.9188
Mains Dimming	60.9467
Casambi	60.9207

* Siehe Treiberkapitel / Refer to the Drivers chapter

2700K
 03.6415.40B
 03.6415.05B
 03.6415.14B

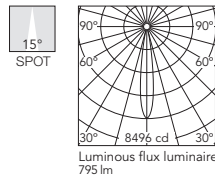

Beam Angle: 15°

h(m)	E(lx)	D(m)
1	8496	0.27
2	2124	0.54
3	944	0.81
4	531	1.09
5	340	1.36

3000K
 03.6416.40B
 03.6416.05B
 03.6416.14B

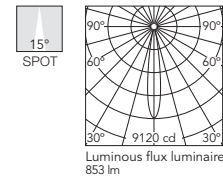

Beam Angle: 15°

h(m)	E(lx)	D(m)
1	9120	0.27
2	2280	0.54
3	1013	0.81
4	570	1.09
5	365	1.36

2700K
 03.6417.40B
 03.6417.05B
 03.6417.14B

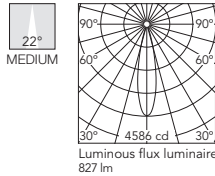

Beam Angle: 22°

h(m)	E(lx)	D(m)
1	4586	0.40
2	1147	0.79
3	510	1.19
4	287	1.58
5	183	1.98

3000K
 03.6418.40B
 03.6418.05B
 03.6418.14B

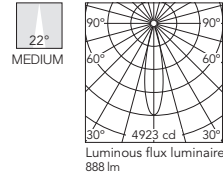

Beam Angle: 22°

h(m)	E(lx)	D(m)
1	4923	0.40
2	1231	0.79
3	547	1.19
4	308	1.58
5	197	1.98

Zubehör / Accessories

Elliptische linse.

Elliptical lens.



08.8418.68A

Honeycomb.

Honeycomb.



08.8419.14A

Floodlinse.

Zum Erreichen von Flood-Optik (35°), Anthony Downlight Medium + Flood-Linse bestellen.

Flood lens.

To obtain flood optics (35°) order Anthony Downlight Medium + flood lens.



08.0050.00

WAN DOWNLIGHT

DESIGNED BY JOHANNA GRAWUNDER



LIGHT SOURCE
LED ARRAY
9,2W
945 lm
3000K/CRI 80



LIGHT SOURCE
LED
QT-14
G9

□ 30 Weiss
30 White

■ 05 Hochglänzendes
Aluminium
05 Polished Aluminium

■ 14 Schwarz
14 Black

■ GN Grün
GN Green



Produktbeschreibung

Deckeneinbauleuchte mit direktem Licht. Halterring aus Aluminium in folgenden Ausführungen: Verchromt, glänzend weiß, glänzend grün und glänzend schwarz. Abblendschirm.

Die Leuchte verfügt über zwei verschiedene Schließringe, glänzend grün und glänzend schwarz, zur Befestigung des gehärteten Sicherheitsglases.

Reflektoren

Sandgestrahlter, chemisch gebleichter Reflektor.

Betriebsgerät

Vorverkabelung zum Anschluss eines externen Betriebsgeräts inbegriffen.

Zusatzinformationen

Schutzgrad IP44.
Schutzklasse II, III je nach Modell.
Auf normal entflammaren Oberflächen einsetzbar.

Qualitätszeichen

Das Gerät entspricht der europäischen technischen Norm EN60598-1 und den entsprechenden Zusatzregelungen.

Description

Ceiling recessed luminary providing direct light. Aluminum ring, available in chrome, shiny white, enameled green, and shiny black finishes. Low glare shield.

Provided by two different ring due to fix the safety tempered glass, in shiny black and enameled green.

Reflectors

Sanded and chemically bleached aluminum reflector.

Power Supply

Pre-wiring included; ready for remote power supply.

Additional Information

IP44 protection grade.
Insulation class II, III depending on the versions.
Suitable for installation on normally inflammable surfaces.

Standard Compliance and Quality Marks

EN60598-1 European Technical Standards and any subsequent additions.

WAN DOWNLIGHT

Wan Downlight

Light Source: LED Array DC 500 mA - 9,2W - 945 lm - 3000K/CRI 80

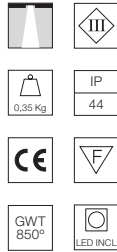
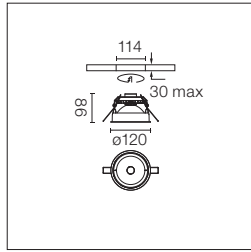

LED Einbauleuchte. Ohne Netzgerät. Recessed luminaire with LED light source. Power supply not included.

Empfohlene Netzgeräte / Recommended power supply*:

Non Dimmable	60.9160
Dimmable 1-10V	60.9188
Dimmable Dali	60.8847
Dimmable Dali 2	60.9222
Mains Dimming	60.9411
Casambi	60.9207

* Siehe Treiberkapitel / Refer to the Drivers chapter

- 03.6154.30A
- 03.6154.05A
- 03.6154.14A
- 03.6154.GNA

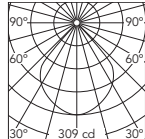

Beam Angle: 83°

h(m)	E(lx)	D(m)
1	309	1.77
2	77	3.55
3	34	5.32
4	19	7.09
5	12	8.87

Luminous flux luminaire
436 lm

Wan Downlight

Light Source: LED QT-14 G9

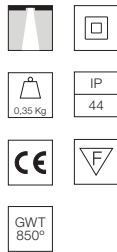
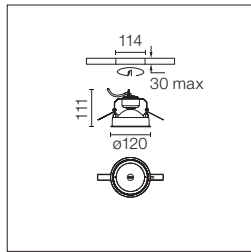

Einbauleuchte für Netzspannung. Recessed luminaire with main voltage source.

- 03.6150.30
- 03.6150.05
- 03.6150.14
- 03.6150.GN

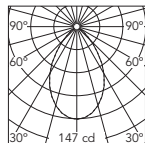

Beam Angle: 68°

h(m)	E(lx)	D(m)
1	147	1.35
2	37	2.70
3	16	4.05
4	9	5.40
5	6	6.75

Luminous flux luminaire
460 lm

@Black Ring

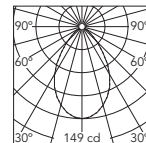

Beam Angle: 69°





h(m)	E(lx)	D(m)
1	149	1.38
2	37	2.75
3	17	4.13
4	9	5.50
5	6	6.88

Luminous flux luminaire
460 lm









@Green Ring

JOHNNY

DESIGNED BY FLOS ARCHITECTURAL

<p>JOHNNY 80 TRIM / NO TRIM 1L ROUND 1L/2L SQUARE</p>  <p>LIGHT SOURCE POWER LED 6,2W 560 lm 2700K/CRI 90 600 lm 3000K/CRI 90</p>	<p>JOHNNY 80 SEMI-RECESSED 1L/2L SQUARE</p>  <p>LIGHT SOURCE POWER LED 6,2W 560 lm 2700K/CRI 90 600 lm 3000K/CRI 90</p>	<p>JOHNNY 120 TRIM / NO TRIM 1L ROUND 1L/2L SQUARE</p>  <p>LIGHT SOURCE LED ARRAY LED ARRAY HIGH PERFORMANCE 18W 1555 lm 2700K/CRI 90 1600 lm 3000K/CRI 90</p>	<p>JOHNNY 120 SEMI-RECESSED 1L/2L SQUARE</p> 
--	--	--	---

<p>Johnny 80 Trim / No Trim</p>  <p>□ 40 Weiss 40 White ■ 14 Schwarz 14 Black</p>	<p>Johnny 120 Trim</p>  <p>□ Weiss White ■ Schwarz Black</p>	<p>Johnny 120 No Trim</p>  <p>■ Schwarz Black</p>
--	--	---

Innen / Inside	□ Weiss White	■ Schwarz Black		
Außen / Outside	□ 40 Weiss 40 White	■ CE Zement CE Concrete	■ TK Teak-Holz TK Teak	■ 14 Schwarz 14 Black
Johnny 80 Semi-Recessed				
Johnny 120 Semi-Recessed				

Ist bis in alle Richtungen hin schwenkbar.
Can be rotated in any direction.



JOHNNY

Produktbeschreibung

Beleuchtungssystem mit einem oder zwei verstellbaren Strahlern als Einbaumodell (Trim und No Trim) und Halbeinbaumodell für die Deckenmontage. Erhältlich in zwei Größen: 80 mm und 120 mm in runder und quadratischer Ausführung. Exklusives, leicht zu befestigendes Ausrichtungssystem ermöglicht die präzise Ausrichtung des Lichtstrahls.

Betriebsgerät

Gleichstrom-Netzgerät mit 220/240 V Fernsteuerung nicht inbegriffen.

Zubehör

Johnny 80:
- Querabschirmung und Honeycomb mitgeliefert
Johnny 120:
- Querabschirmung
- Honeycomb
- Elliptische Linse
- Floodlinse

Zusatzinformationen

Im Modell Johnny 80 ist das Ausrichtungssystem im Teleskopgehäuse eingebaut.
Schutzgrad IP20.
Auf normal entflammaren Oberflächen einsetzbar.

Qualitätszeichen

Das Gerät entspricht der europäischen technischen Norm EN60598-1 und den entsprechenden Zusatzregelungen.

Description

Illumination system consisting of one or two adjustable lights, in the embedded version (Trim and No Trim) and semi-embedded version to be installed on the ceiling. Available in two sizes: 80 mm and 120 mm in round and square versions. An exclusive, easy and adjustable system that enables an accurate adjustment of the light beam.

Power Supply

Remote constant power supply 220/240V not included.

Accessories

Johnny 80:
- Screening crosspiece and honeycomb included in the product
Johnny 120:
- Screening crosspiece
- Honeycomb
- Elliptical lens
- Flood lens

Additional Information

The Johnny 80 version has a orientation system integrated into the telescopic body.
IP20 protection grade.
Suitable for installation on normally inflammable surfaces.

Standard Compliance and Quality Marks

EN60598-1 European Technical Standards and any subsequent additions.



Johnny 80
1L Trim



Johnny 80
1L No Trim



Johnny 80
2L Trim



Johnny 80
2L No Trim



Johnny 80
Semi-Recessed



Johnny 120
Trim



Johnny 120
No Trim



Johnny 120
Semi-Recessed

JOHNNY 80

Johnny Ø80 Trim 1L Round

Light Source: Power LED

Without accessories: DC 500 mA - 6,2W - 560 lm - 2700K/CRI 90 / 6,2W - 600 lm - 3000K/CRI 90

With accessories: DC 450 mA - 5,5W - 505 lm - 2700K/CRI 90 / 5,5W - 540 lm - 3000K/CRI 90

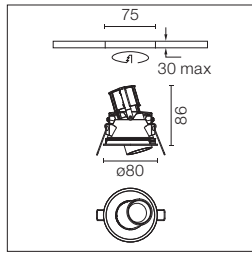

LED Einbauleuchte. Ohne Netzgerät. Recessed luminaire with LED light source. Power supply not included.

Inkludiertes Zubehör (Honeycomb und Blendschutzgitter). Accessories included (honeycomb and screening crosspiece).

Johnny Ø80 No Trim 1L Round

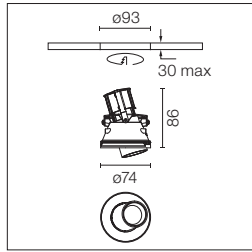

Empfohlene Netzgeräte / Recommended power supply*:

	450 mA	500 mA
Non Dimmable	60.9160	60.9160
Dimmable 1-10V	60.9188	60.9188
Dimmable Dali 1	60.8847	60.8847
Dimmable Dali 2	60.9222	60.9222
Mains Dimming	60.9467	60.9411
Casambi	60.9207	60.9207

* Siehe Treiberkapitel / Refer to the Drivers chapter

- 2700K**
- 03.0701.40A
 - 03.0701.14A
 - 03.0701.40ANT
 - 03.0701.14ANT

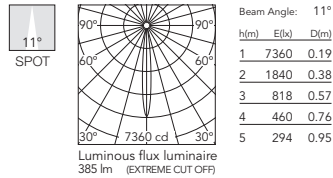

- 3000K**
- 03.0700.40A
 - 03.0700.14A
 - 03.0700.40ANT
 - 03.0700.14ANT

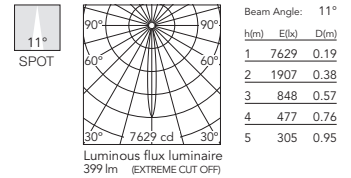

- 2700K**
- 03.0705.40A
 - 03.0705.14A
 - 03.0705.40ANT
 - 03.0705.14ANT

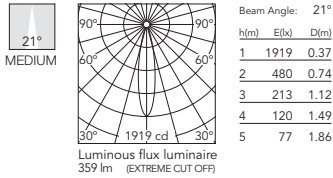

- 3000K**
- 03.0704.40A
 - 03.0704.14A
 - 03.0704.40ANT
 - 03.0704.14ANT

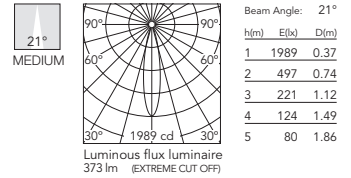

- 2700K**
- 03.0709.40A
 - 03.0709.14A
 - 03.0709.40ANT
 - 03.0709.14ANT

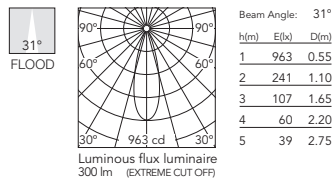

- 3000K**
- 03.0708.40A
 - 03.0708.14A
 - 03.0708.40ANT
 - 03.0708.14ANT

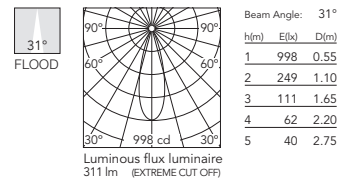

JOHNNY 80

Johnny 80 Trim 1L Square

Light Source: Power LED

Without accessories: DC 500 mA - 6,2W - 560 lm - 2700K/CRI 90 / 6,2W - 600 lm - 3000K/CRI 90

With accessories: DC 450 mA - 5,5W - 505 lm - 2700K/CRI 90 / 5,5W - 540 lm - 3000K/CRI 90

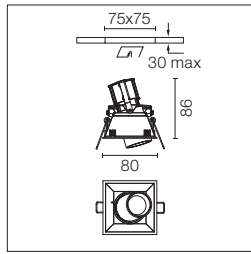

LED Einbauleuchte. Ohne Netzgerät. Recessed luminaire with LED light source. Power supply not included.

Inkludiertes Zubehör (Honeycomb und Blendschutzgitter). Accessories included (honeycomb and screening crosspiece).

Johnny 80 No Trim 1L Square

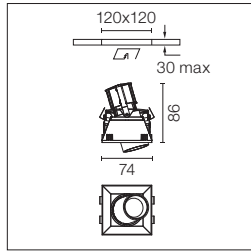

Empfohlene Netzgeräte / Recommended power supply*:

	450 mA	500 mA
Non Dimmable	60.9160	60.9160
Dimmable 1-10V	60.9188	60.9188
Dimmable Dali 1	60.8847	60.8847
Dimmable Dali 2	60.9222	60.9222
Mains Dimming	60.9467	60.9411
Casambi	60.9207	60.9207

* Siehe Treiberkapitel / Refer to the Drivers chapter

- 2700K**
- 03.0703.40A
 - 03.0703.14A
- 03.0703.40ANT
- 03.0703.14ANT

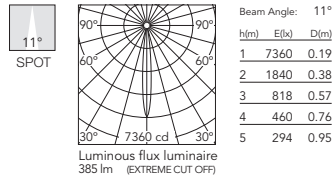

- 3000K**
- 03.0702.40A
 - 03.0702.14A
- 03.0702.40ANT
- 03.0702.14ANT

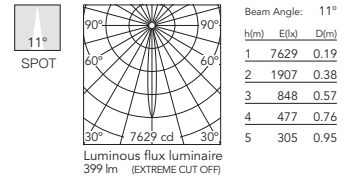

- 2700K**
- 03.0707.40A
 - 03.0707.14A
- 03.0707.40ANT
- 03.0707.14ANT

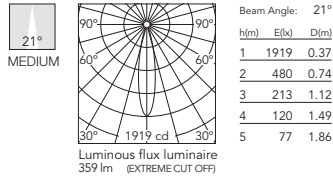

- 3000K**
- 03.0706.40A
 - 03.0706.14A
- 03.0706.40ANT
- 03.0706.14ANT

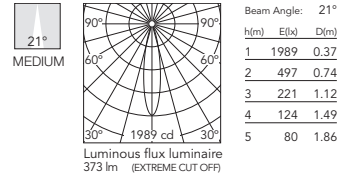

- 2700K**
- 03.0711.40A
 - 03.0711.14A
- 03.0711.40ANT
- 03.0711.14ANT

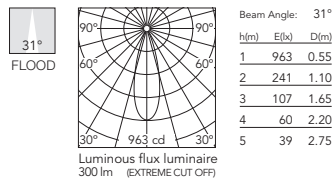

- 3000K**
- 03.0710.40A
 - 03.0710.14A
- 03.0710.40ANT
- 03.0710.14ANT

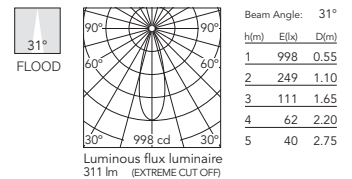

JOHNNY 80

Johnny 80 Trim 2L Square

Light Source: Power LED

Without accessories: 500 mA - 2x6,2W - 2x560 lm - 2700K/CRI 90 / 2x6,2W - 2x600 lm - 3000K/CRI 90

With accessories: DC 450 mA - 2x5,5W - 2x505 lm - 2700K/CRI 90 / 2x5,5W - 2x540 lm - 3000K/CRI 90

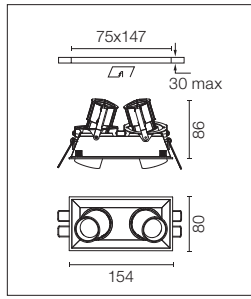

LED Einbauleuchte. Ohne Netzgerät. Für jeden Optikkörper ist ein Netzgerät erforderlich.

Recessed luminaire with LED light source. Power supply not included. Requires one power supply for each optic body.

Inkludiertes Zubehör (Honeycomb und Blendschutzgitter).

Accessories included (honeycomb and screening crosspiece).

Johnny 80 No Trim 2L Square

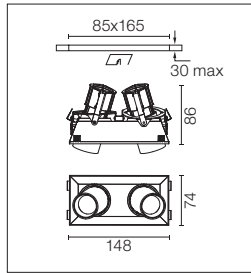

Vorinstallationsrahmen. Muss separat bestellt werden.

Pre-installation frame. To be ordered separately.

Empfohlene Netzgeräte / Recommended power supply*:

	450 mA	500 mA
Non Dimmable	60.9160	60.9160
Dimmable 1-10V	60.9188	60.9188
Dimmable Dali 1	60.8847	60.8847
Dimmable Dali 2	60.9222	60.9222
Mains Dimming	60.9467	60.9411
Casambi	60.9207	60.9207

* Siehe Treiberkapitel / Refer to the Drivers chapter

- 2700K**
- ☐ 03.0713.40A
 - 03.0713.14A
 - ☐ 03.0713.40ANT
 - 03.0713.14ANT

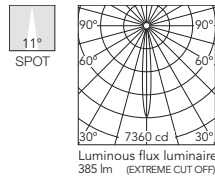

- 3000K**
- ☐ 03.0712.40A
 - 03.0712.14A
 - ☐ 03.0712.40ANT
 - 03.0712.14ANT

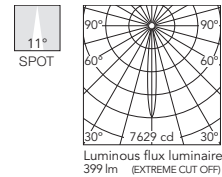

- 2700K**
- ☐ 03.0715.40A
 - 03.0715.14A
 - ☐ 03.0715.40ANT
 - 03.0715.14ANT

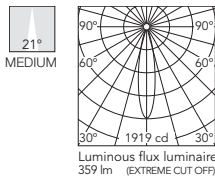

- 3000K**
- ☐ 03.0714.40A
 - 03.0714.14A
 - ☐ 03.0714.40ANT
 - 03.0714.14ANT

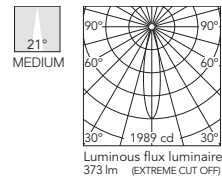

- 2700K**
- ☐ 03.0717.40A
 - 03.0717.14A
 - ☐ 03.0717.40ANT
 - 03.0717.14ANT

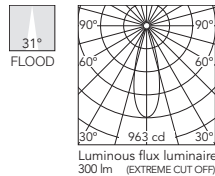

- 3000K**
- ☐ 03.0716.40A
 - 03.0716.14A
 - ☐ 03.0716.40ANT
 - 03.0716.14ANT

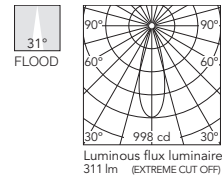

JOHNNY 80

Johnny 80 Semi-Recessed 1L Square

Light Source: Power LED

Without accessories: DC 500 mA - 6,2W - 560 lm - 2700K/CRI 90 / 6,2W - 600 lm - 3000K/CRI 90

With accessories: DC 450 mA - 5,5W - 505 lm - 2700K/CRI 90 / 5,5W - 540 lm - 3000K/CRI 90

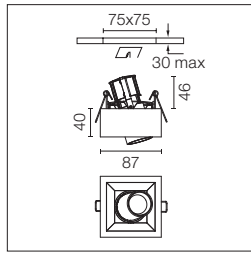

LED Halbeinbauleuchte. Ohne Netzgerät.

Semi-recessed luminaire with LED light source. Power supply not included.

Inkludiertes Zubehör (Honeycomb und Blendschutzgitter).

Accessories included (honeycomb and screening crosspiece).

E= Außenfarbe
I= Innenfarbe

E= External Finish
I= Internal Finish



Empfohlene Netzgeräte / Recommended power supply*:

	450 mA	500 mA
Non Dimmable	60.9160	60.9160
Dimmable 1-10V	60.9188	60.9188
Dimmable Dali 1	60.8847	60.8847
Dimmable Dali 2	60.9222	60.9222
Mains Dimming	60.9467	60.9411
Casambi	60.9207	60.9207

* Siehe Treiberkapitel / Refer to the Drivers chapter

E I 2700K

□	□	03.0761.40A
■	□	03.0761.CEA
■	■	03.0761.TKA
■	■	03.0761.14A

E I

□	□	03.0719.40A
■	□	03.0719.CEA
■	■	03.0719.TKA
■	■	03.0719.14A

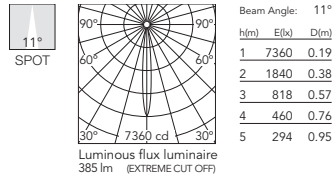

E I 3000K

□	□	03.0760.40A
■	□	03.0760.CEA
■	■	03.0760.TKA
■	■	03.0760.14A

E I

□	□	03.0718.40A
■	□	03.0718.CEA
■	■	03.0718.TKA
■	■	03.0718.14A

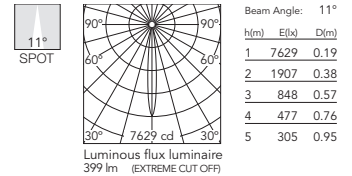

E I 2700K

□	□	03.0763.40A
■	□	03.0763.CEA
■	■	03.0763.TKA
■	■	03.0763.14A

E I

□	□	03.0721.40A
■	□	03.0721.CEA
■	■	03.0721.TKA
■	■	03.0721.14A

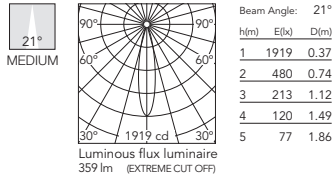

E I 3000K

□	□	03.0762.40A
■	□	03.0762.CEA
■	■	03.0762.TKA
■	■	03.0762.14A

E I

□	□	03.0720.40A
■	□	03.0720.CEA
■	■	03.0720.TKA
■	■	03.0720.14A

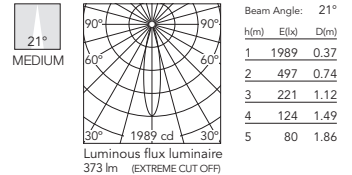

E I 2700K

□	□	03.0765.40A
■	□	03.0765.CEA
■	■	03.0765.TKA
■	■	03.0765.14A

E I

□	□	03.0723.40A
■	□	03.0723.CEA
■	■	03.0723.TKA
■	■	03.0723.14A

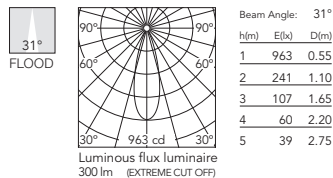

E I 3000K

□	□	03.0764.40A
■	□	03.0764.CEA
■	■	03.0764.TKA
■	■	03.0764.14A

E I

□	□	03.0722.40A
■	□	03.0722.CEA
■	■	03.0722.TKA
■	■	03.0722.14A

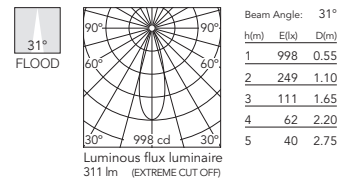

JOHNNY 80

Johnny 80 Semi-Recessed 2L Square

Light Source: Power LED

Without accessories: 500 mA - 2x6,2W - 2x560 lm - 2700K/CRI 90 / 2x6,2W - 2x600 lm - 3000K/CRI 90

With accessories: DC 450 mA - 2x5,5W - 2x505 lm - 2700K/CRI 90 / 2x5,5W - 2x540 lm - 3000K/CRI 90

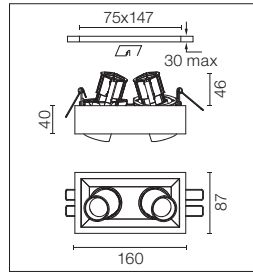

LED Halbeinbauleuchte. Ohne Netzgerät. Für jeden Optikkörper ist ein Netzgerät erforderlich.

Semi-recessed luminaire with LED light source. Power supply not included. Requires one power supply for each optic body.

Inkludiertes Zubehör (Honeycomb und Blendschutzgitter).

Accessories included (honeycomb and screening crosspiece).

E= Außenfarbe
I= Innenfarbe

E= External Finish
I= Internal Finish



Empfohlene Netzgeräte / Recommended power supply*:

	450 mA	500 mA
Non Dimmable	60.9160	60.9160
Dimmable 1-10V	60.9188	60.9188
Dimmable Dali 1	60.8847	60.8847
Dimmable Dali 2	60.9222	60.9222
Mains Dimming	60.9467	60.9411
Casambi	60.9207	60.9207

* Siehe Treiberkapitel / Refer to the Drivers chapter

E I 2700K

03.0771.40A
03.0771.CEA
03.0771.TKA
03.0771.14A

E I

03.0731.40A
03.0731.CEA
03.0731.TKA
03.0731.14A

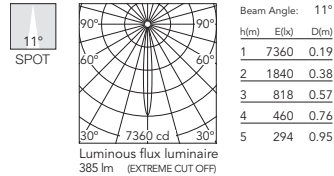

E I 3000K

03.0770.40A
03.0770.CEA
03.0770.TKA
03.0770.14A

E I

03.0730.40A
03.0730.CEA
03.0730.TKA
03.0730.14A

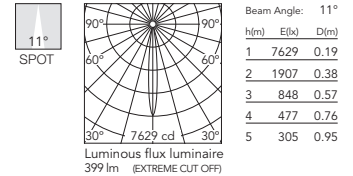

E I 2700K

03.0773.40A
03.0773.CEA
03.0773.TKA
03.0773.14A

E I

03.0733.40A
03.0733.CEA
03.0733.TKA
03.0733.14A

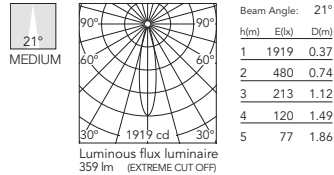

E I 3000K

03.0772.40A
03.0772.CEA
03.0772.TKA
03.0772.14A

E I

03.0732.40A
03.0732.CEA
03.0732.TKA
03.0732.14A

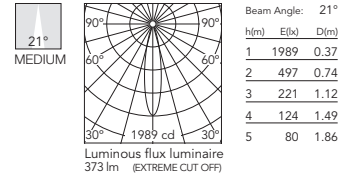

E I 2700K

03.0775.40A
03.0775.CEA
03.0775.TKA
03.0775.14A

E I

03.0735.40A
03.0735.CEA
03.0735.TKA
03.0735.14A

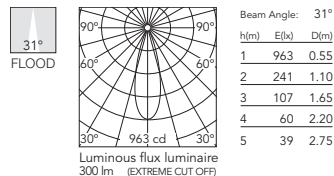

E I 3000K

03.0774.40A
03.0774.CEA
03.0774.TKA
03.0774.14A

E I

03.0734.40A
03.0734.CEA
03.0734.TKA
03.0734.14A

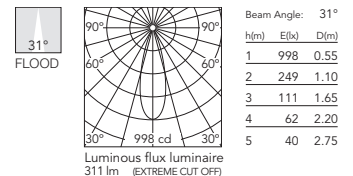

JOHNNY 80

Zubehör / Accessories

Johnny 80 No Trim 1L

Installationsrahmen No Trim.
Johnny ø80.



Johnny ø80 Round
 08.9102.00

Installation frame No Trim.
Johnny ø80.

Installationsrahmen No Trim.
Johnny □80.



Johnny □80 Square
 08.9103.00

Installation frame No Trim.
Johnny □80.

Johnny 80 No Trim 2L Square

Installationsrahmen No Trim.
Johnny 80 2L Square.



08.9105.00

Installation frame No Trim.
Johnny 80 2L Square.

JOHNNY 120

Johnny 120 Light Source

Light Source: LED Array / LED Array High Performance

Without accessories: DC 500 mA - 18W - 1770 lm - 2700K/CRI 90 / 18W - 1870 lm - 3000K/CRI 90

With accessories: DC 450 mA - 16W - 1612 lm - 2700K/CRI 90 / 16W - 1704 lm - 3000K/CRI 90

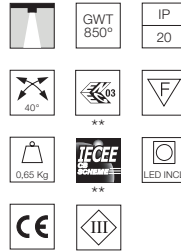
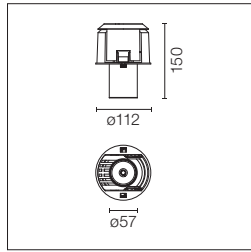

LED Einbauleuchte. Ohne Netzgerät. Recessed luminaire with LED light source. Power supply not included. Es wird ein Gerät als Lichtquelle benötigt. One driver is needed per each light source.

**Part number with certificate: 0741 / 0743 / 0745 / 0740 / 0742 / 0744

Empfohlene Netzgeräte / Recommended power supply*:

Non Dimmable	60.9160
Dimmable 1-10V	60.9188
Dimmable Dali 1	60.8847
Dimmable Dali 2	60.9222
Mains Dimming	60.9467
Casambi	60.9207

* Siehe Treiberkapitel / Refer to the Drivers chapter

High Performance 2700K

03.0801.40
03.0801.14

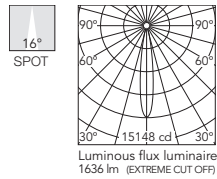

Beam Angle: 16°

h(m)	E(lx)	D(m)
1	15148	0.28
2	3787	0.56
3	1683	0.84
4	947	1.12
5	606	1.40

High Performance 3000K

03.0800.40
03.0800.14

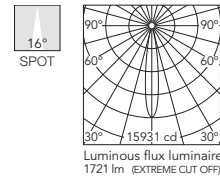

Beam Angle: 16°

h(m)	E(lx)	D(m)
1	15931	0.28
2	3983	0.56
3	1770	0.84
4	996	1.12
5	637	1.40

2700K

03.0741.40
03.0741.14

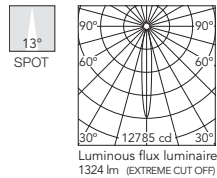

Beam Angle: 13°

h(m)	E(lx)	D(m)
1	12785	0.22
2	3196	0.44
3	1421	0.66
4	799	0.88
5	511	1.10

3000K

03.0740.40
03.0740.14

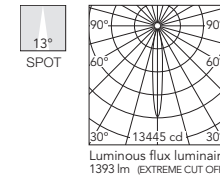

Beam Angle: 13°

h(m)	E(lx)	D(m)
1	13445	0.22
2	3361	0.44
3	1494	0.66
4	840	0.88
5	538	1.10

High Performance 2700K

03.0803.40
03.0803.14

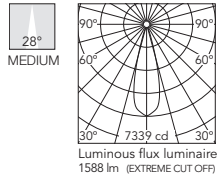

Beam Angle: 28°

h(m)	E(lx)	D(m)
1	7339	0.50
2	1835	1.00
3	815	1.50
4	459	2.00
5	294	2.50

High Performance 3000K

03.0802.40
03.0802.14

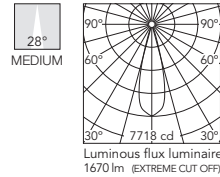

Beam Angle: 28°

h(m)	E(lx)	D(m)
1	7718	0.50
2	1930	1.00
3	858	1.50
4	482	2.00
5	309	2.50

2700K

03.0743.40
03.0743.14

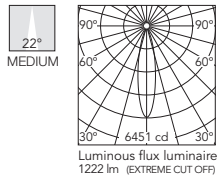

Beam Angle: 22°

h(m)	E(lx)	D(m)
1	6451	0.39
2	1613	0.79
3	717	1.18
4	403	1.58
5	258	1.97

3000K

03.0742.40
03.0742.14

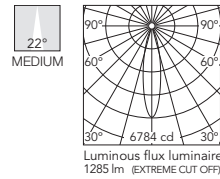

Beam Angle: 22°

h(m)	E(lx)	D(m)
1	6784	0.39
2	1696	0.79
3	754	1.18
4	424	1.58
5	271	1.97

High Performance 2700K

03.0805.40
03.0805.14

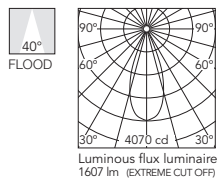

Beam Angle: 40°

h(m)	E(lx)	D(m)
1	4070	0.73
2	1017	1.46
3	452	2.18
4	254	2.91
5	163	3.64

High Performance 3000K

03.0804.40
03.0804.14

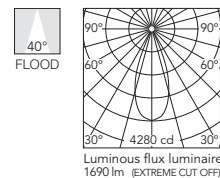

Beam Angle: 40°

h(m)	E(lx)	D(m)
1	4280	0.73
2	1070	1.46
3	476	2.18
4	268	2.91
5	171	3.64

2700K

03.0745.40
03.0745.14

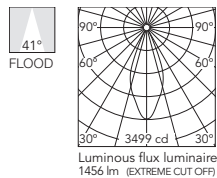

Beam Angle: 41°

h(m)	E(lx)	D(m)
1	3499	0.75
2	875	1.50
3	389	2.25
4	219	3.00
5	140	3.75

3000K

03.0744.40
03.0744.14

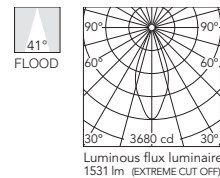

Beam Angle: 41°

h(m)	E(lx)	D(m)
1	3680	0.75
2	920	1.50
3	409	2.25
4	230	3.00
5	147	3.75

JOHNNY 120

Johnny 120 Round 1L – Recessed Universal Frame

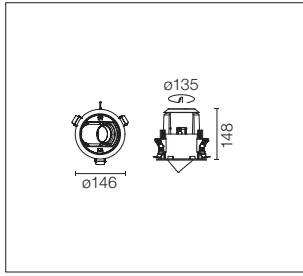

Einmalige Referenz für Trim- oder No-Trim-Deckeneinbau.
 08.0555.00=enthält weißer Rahmen, um den Trim-Einbau zu vervollständigen.
 08.0505.00=enthält, optional, weißer und schwarzer Rahmen, um den Trim-Einbau zu vervollständigen.

Unique reference for Trim or No Trim recessed installation.
 08.0555.00=includes white frame to complete Trim finishing.
 08.0505.00=includes optional white and black frames to complete Trim finishing.

- 08.0555.00
- +
- 1x Light Source
- +
- 1x Driver

- 08.0505.00
- +
- 1x Light Source
- +
- 1x Driver

Johnny 120 Square 1L – Recessed Universal Frame

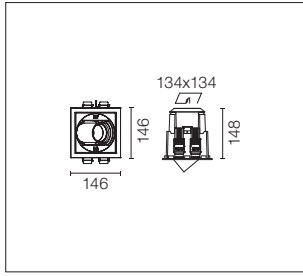

Einmalige Referenz für Trim- oder No-Trim-Deckeneinbau.
 08.0550.00=enthält weißer Rahmen, um den Trim-Einbau zu vervollständigen.
 08.0500.00=enthält, optional, weißer und schwarzer Rahmen, um den Trim-Einbau zu vervollständigen.

Unique reference for Trim or No Trim recessed installation.
 08.0550.00=includes white frame to complete Trim finishing.
 08.0500.00=includes optional white and black frames to complete Trim finishing.

- 08.0550.00
- +
- 1x Light Source
- +
- 1x Driver

- 08.0500.00
- +
- 1x Light Source
- +
- 1x Driver

Johnny 120 Square 2L – Recessed Universal Frame

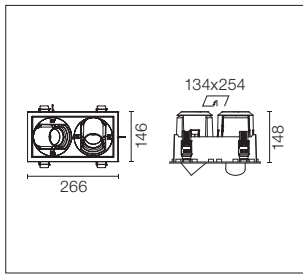
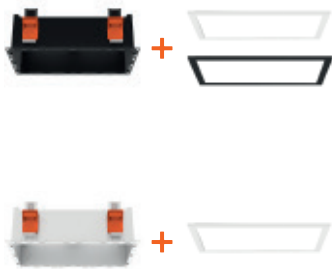

Einmalige Referenz für Trim- oder No-Trim-Deckeneinbau.
 08.0551.00=enthält weißer Rahmen, um den Trim-Einbau zu vervollständigen.
 08.0501.00=enthält, optional, weißer und schwarzer Rahmen, um den Trim-Einbau zu vervollständigen.

Unique reference for Trim or No Trim recessed installation.
 08.0551.00=includes white frame to complete Trim finishing.
 08.0501.00=includes optional white and black frames to complete Trim finishing.

- 08.0551.00
- +
- 2x Light Source
- +
- 2x Driver

- 08.0501.00
- +
- 2x Light Source
- +
- 2x Driver

Johnny 120 Semi-Recessed 1L Square – Housing

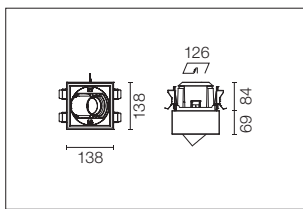

- | | |
|---|---|
| E | I |
| | |
| | |
| | |
| | |
- 08.0556.40
 - 08.0556.CE
 - 08.0556.TK
 - 08.0556.14
 - +
 - 1x Light Source
 - +
 - 1x Driver

- | | |
|---|---|
| E | I |
| | |
| | |
| | |
| | |
- 08.0506.40
 - 08.0506.CE
 - 08.0506.TK
 - 08.0506.14
 - +
 - 1x Light Source
 - +
 - 1x Driver

Johnny 120 Semi-Recessed 2L Square – Housing



- | | |
|---|---|
| E | I |
| | |
| | |
| | |
| | |
- 08.0557.40
 - 08.0557.CE
 - 08.0557.TK
 - 08.0557.14
 - +
 - 2x Light Source
 - +
 - 2x Driver

- | | |
|---|---|
| E | I |
| | |
| | |
| | |
| | |
- 08.0507.40
 - 08.0507.CE
 - 08.0507.TK
 - 08.0507.14
 - +
 - 2x Light Source
 - +
 - 2x Driver

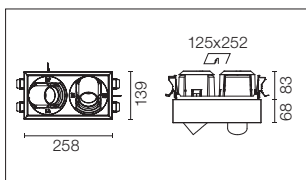

JOHNNY 120

Zubehör / Accessories

Johnny 120

Querabschirmung
Screening crosspiece



08.8429.00

Elliptische Linse
Elliptical lens



08.8431.00

Johnny 120

Floodlinse
Flood lens



08.8432.00

Honeycomb
Honeycomb



08.8428.00

Konische Abschirmung
Snoot shielding cone



































08.0526.00

HOW TO ORDER JOHNNY 120

TRIM / NO TRIM 1L ROUND					TRIM / NO TRIM 1L SQUARE					TRIM / NO TRIM 2L SQUARE				
Universal frame 					Universal frame 					Universal frame 				
08.0505.00 + 08.0555.00					08.0500.00 + 08.0550.00					08.0501.00 + 08.0551.00				
1x Light Source* 					1x Light Source* 					2x Light Source* 				
	2700K	3000K	2700K High Perf.	3000K High Perf.		2700K	3000K	2700K High Perf.	3000K High Perf.		2700K	3000K	2700K High Perf.	3000K High Perf.
Spot	03.0741.40 03.0741.14	03.0740.40 03.0740.14	03.0801.40 03.0801.14	03.0800.40 03.0800.14	Spot	03.0741.40 03.0741.14	03.0740.40 03.0740.14	03.0801.40 03.0801.14	03.0800.40 03.0800.14	Spot	03.0741.40 03.0741.14	03.0740.40 03.0740.14	03.0801.40 03.0801.14	03.0800.40 03.0800.14
Medium	03.0743.40 03.0743.14	03.0742.40 03.0742.14	03.0803.40 03.0803.14	03.0802.40 03.0802.14	Medium	03.0743.40 03.0743.14	03.0742.40 03.0742.14	03.0803.40 03.0803.14	03.0802.40 03.0802.14	Medium	03.0743.40 03.0743.14	03.0742.40 03.0742.14	03.0803.40 03.0803.14	03.0802.40 03.0802.14
Flood	03.0745.40 03.0745.14	03.0744.40 03.0744.14	03.0805.40 03.0805.14	03.0804.40 03.0804.14	Flood	03.0745.40 03.0745.14	03.0744.40 03.0744.14	03.0805.40 03.0805.14	03.0804.40 03.0804.14	Flood	03.0745.40 03.0745.14	03.0744.40 03.0744.14	03.0805.40 03.0805.14	03.0804.40 03.0804.14
No Trim 					No Trim 					No Trim 				
Trim White 					Trim White 					Trim White 				
Trim Black 					Trim Black 					Trim Black 				

* Ohne Netzgerät. Es wird ein Gerät als Lichtquelle benötigt / Power supply not included. One driver is needed per each light source.

HOW TO ORDER JOHNNY 120

SEMI-RECESSED 1L SQUARE				SEMI-RECESSED 2L SQUARE					
Housing				Housing					
									
08.0506.40	08.0506.CE	08.0506.TK	08.0506.14	08.0507.40	08.0507.CE	08.0507.TK	08.0507.14		
									
08.0556.40	08.0556.CE	08.0556.TK	08.0556.14	08.0557.40	08.0557.CE	08.0557.TK	08.0557.14		
+ 1x Light Source*				+ 2x Light Source*					
									
	2700K	3000K	2700K High Perf.	3000K High Perf.		2700K	3000K	2700K High Perf.	3000K High Perf.
Spot	03.0741.40 03.0741.14	03.0740.40 03.0740.14	03.0801.40 03.0801.14	03.0800.40 03.0800.14	Spot	03.0741.40 03.0741.14	03.0740.40 03.0740.14	03.0801.40 03.0801.14	03.0800.40 03.0800.14
Medium	03.0743.40 03.0743.14	03.0742.40 03.0742.14	03.0803.40 03.0803.14	03.0802.40 03.0802.14	Medium	03.0743.40 03.0743.14	03.0742.40 03.0742.14	03.0803.40 03.0803.14	03.0802.40 03.0802.14
Flood	03.0745.40 03.0745.14	03.0744.40 03.0744.14	03.0805.40 03.0805.14	03.0804.40 03.0804.14	Flood	03.0745.40 03.0745.14	03.0744.40 03.0744.14	03.0805.40 03.0805.14	03.0804.40 03.0804.14
=				=					
									
									
White	Concrete	Teak	Black	White	Concrete	Teak	Black		

* Ohne Netzgerät. Es wird ein Gerät als Lichtquelle benötigt / Power supply not included. One driver is needed per each light source.

COMPASS BOX RECESSED

DESIGNED BY FLOS ARCHITECTURAL



SMALL 1L / 2L



LIGHT SOURCE
LED ARRAY
9,2W
945 lm
3000K/CRI 80

SMALL 1L / 2L



LIGHT SOURCE
LED
QR-CBC 51
GX5.3

LARGE 1L / 2L



LIGHT SOURCE
LED
QR-111
G53

□ 30 Mattweiss/RAL 9001
30 Matt White



■ 14 Mattschwarz/RAL 9005
14 Matt Black



Schwenkbar um 20°.
Can be swivelled 20°.

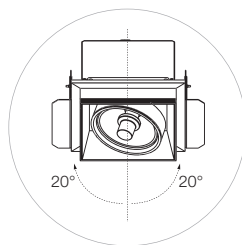

Produktbeschreibung

Strahlersystem mit 1 oder 2 schwenkbaren Lichtquellen zum Einbau in abgehängte Decken mit 1 bis 30 mm Dicke. Geeignet für LED-Lichtquellen. Einbaukörper aus mattschwarz lackiertem Pressstahl und Einbaugehäuse aus Aluminiumguss mit Befestigungsvorrichtung für abgehängte Decken. Das kardanische Ausrichtsystem ist aus mattschwarz pulverlackiertem Stahl. Für LED retrofit Versionen: Ein innovativer Blockiermechanismus mit schwarz lackierter Schraubenspernung. Klemmkasten für den Elektroanschluss über der Leuchtmittelhalterung.

Reflektoren

Reflektoren aus glänzend silbern eloxiertem Reinstaluminium.

Betriebsgerät

Vorverkabelung für externes Betriebsgerät inbegriffen. Für LED retrofit Versionen:
- Elektronischer Transformator 20/105W, 220/240V, 50/60Hz mit "leading and trailing edge" Dimmer (Phasen- und Phasenabschnittdimmer).

Zubehör

- Schwarz lackierter Abschirmzylinder mit eingebautem Orientierungsrastrer.
- Honeycomb.
- Einbaugehäuse für abgehängte Decken.

Zusatzinformationen

Das kardanische Ausrichtsystem erlaubt einen Schwenkbereich von 40° in alle Richtungen. Schutzgrad IP20. Schutzklasse I, III je nach Modell.

Qualitätszeichen

Das Gerät entspricht der europäischen technischen Norm EN60598-1 und den entsprechenden Zusatzregelungen.

Description

1 or 2 lamp adjustable- system, for recessed ceiling thicknesses of 1-30 mm. Suitable for LED light sources. Pressed steel powder-coated recessed housing, extruded aluminum recessed trim frame for use with false ceiling systems. Steel "compass-type" adjustment mechanism, powder-coated matt black. For LED retrofit versions: innovative steel bracket fixing system, painted black, with allen key locking mechanism. Terminal block positioned on canopy housing box.

Reflectors

Super-pure, anodised-aluminum, silver reflectors with polished specular finish. Black thermoplastic protective ring for high luminance lamps.

Power Supply

Pre-wiring included; ready for remote power supply. For LED retrofit versions:
- Electronic transformer 20/105W, 220/240V, 50/60Hz suitable for dimming when used with trailing edge dimmers.

Accessories

- Screening cylinder with cross baffle element incorporated, black powder-coated finish.
- Honeycomb.
- Frame needed for installation on false ceiling.

Additional Information

Compass-type adjustment system permits focusing from 0° to 40° in all directions. IP20 protection grade. Insulation class I, III depending on the versions.

Standard Compliance and Quality Marks

EN60598-1 European Technical Standards and any subsequent additions.

COMPASS BOX RECESSED

Compass Box Recessed Small 1L

Light Source: LED Array DC 500 mA - 9,2W - 945 lm - 3000K/CRI 80

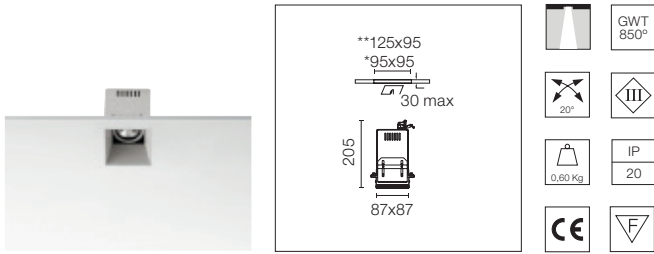

* Zugängliche Decke: module/open. | Accessible ceiling: modular/open.
 **Nicht zugängliche Decke. | Inaccessible ceiling.

No Trim LED Einbauleuchte. Ohne Netzgerät.

No Trim recessed luminaire with LED light source. Power supply not included.

Der Rahmen für das Einbaugehäuse ist getrennt zu bestellen.

Pre-installation frame must be ordered separately.

Empfohlene Netzgeräte / Recommended power supply*:

Non Dimmable	60.9160
Dimmable 1-10V	60.9188
Dimmable Dali	60.8847
Dimmable Dali 2	60.9222
Mains Dimming	60.9411
Casambi	60.9207

* Siehe Treiberkapitel / Refer to the Drivers chapter

03.2675.30A
03.2675.14A

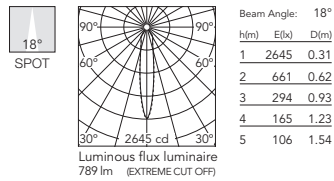

03.2677.30A
03.2677.14A

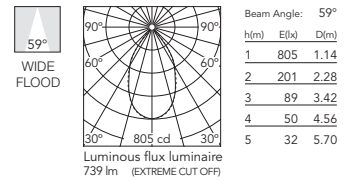

03.2676.30A
03.2676.14A

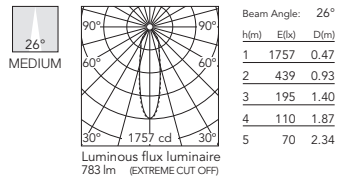

Compass Box Recessed Small 2L

Light Source: LED Array DC 500 mA - 2x9,2W - 2x945 lm - 3000K/CRI 80

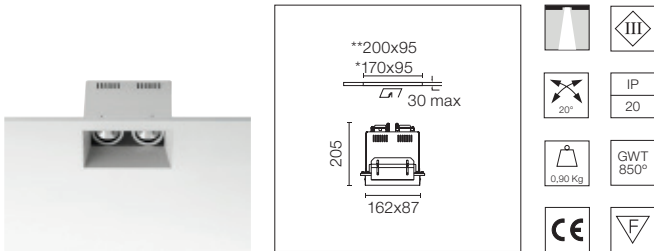

* Zugängliche Decke: module/open. | Accessible ceiling: modular/open.
 **Nicht zugängliche Decke. | Inaccessible ceiling.

No Trim LED Einbauleuchte. Ohne Netzgerät. Für jeden Optikkörper ist ein Netzgerät erforderlich.

No Trim recessed luminaire with LED light source. Power supply not included. Requires one power supply for each optic body.

Der Rahmen für das Einbaugehäuse ist getrennt zu bestellen.

Pre-installation frame must be ordered separately.

Empfohlene Netzgeräte / Recommended power supply*:

Non Dimmable	60.9160
Dimmable 1-10V	60.9188
Dimmable Dali	60.8847
Dimmable Dali 2	60.9222
Mains Dimming	60.9411
Casambi	60.9207

* Siehe Treiberkapitel / Refer to the Drivers chapter

03.2680.30A
03.2680.14A

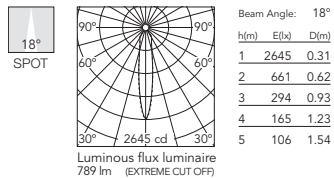

03.2682.30A
03.2682.14A

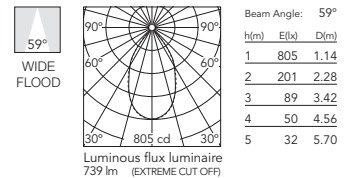

03.2681.30A
03.2681.14A

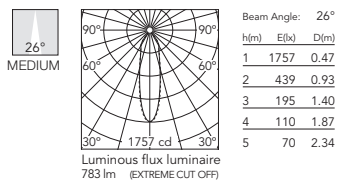

COMPASS BOX RECESSED

Compass Box Recessed Small 1L

Light Source: LED QR-CBC 51 GX5.3

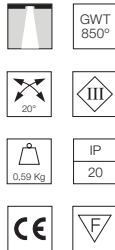
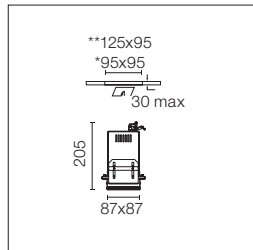

Einbauleuchte No Trim für 12 V LED-Retrofit-Lampe. Separater Transformator nicht inbegriffen.

No Trim recessed luminaire for 12V LED Retrofit lamp. Remote transformer not included.

Der Rahmen für das Einbaugehäuse ist getrennt zu bestellen.

Pre-installation frame must be ordered separately.

03.2650.30
03.2650.14

* Zugängliche Decke: module/open. | Accessible ceiling: modular/open.
**Nicht zugängliche Decke. | Inaccessible ceiling.

Compass Box Recessed Small 2L

Light Source: LED QR-CBC 51 GX5.3

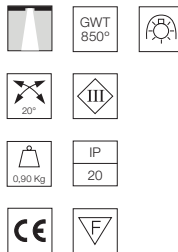
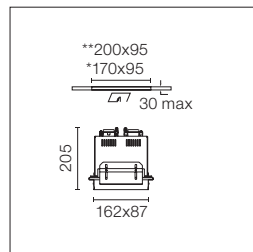

Einbauleuchte No Trim für 12 V LED-Retrofit-Lampe. Separater Transformator nicht inbegriffen.

No Trim recessed luminaire for 12V LED Retrofit lamp. Remote transformer not included.

Der Rahmen für das Einbaugehäuse ist getrennt zu bestellen.

Pre-installation frame must be ordered separately.

03.2651.30
03.2651.14

* Zugängliche Decke: module/open. | Accessible ceiling: modular/open.
**Nicht zugängliche Decke. | Inaccessible ceiling.

Compass Box Recessed Large 1L

Light Source: LED QR-111 G53

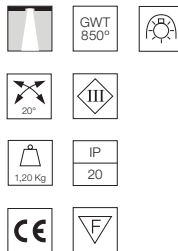
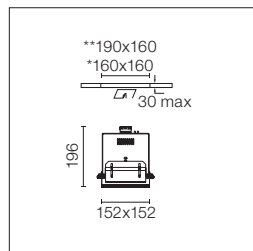

Einbauleuchte No Trim für 12 V LED-Retrofit-Lampe. Separater Transformator nicht inbegriffen.

No Trim recessed luminaire for 12V LED Retrofit lamp. Remote transformer not included.

Der Rahmen für das Einbaugehäuse ist getrennt zu bestellen.

Pre-installation frame must be ordered separately.

03.2520.30
03.2520.14

* Zugängliche Decke: module/open. | Accessible ceiling: modular/open.
**Nicht zugängliche Decke. | Inaccessible ceiling.

Compass Box Recessed Large 2L

Light Source: LED QR-111 G53

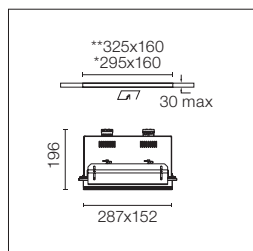

Einbauleuchte No Trim für 12 V LED-Retrofit-Lampe. Separater Transformator nicht inbegriffen.

No Trim recessed luminaire for 12V LED Retrofit lamp. Remote transformer not included.

Der Rahmen für das Einbaugehäuse ist getrennt zu bestellen.

Pre-installation frame must be ordered separately.

03.2521.30
03.2521.14

* Zugängliche Decke: module/open. | Accessible ceiling: modular/open.
**Nicht zugängliche Decke. | Inaccessible ceiling.

COMPASS BOX RECESSED

Zubehör / Accessories

Compass Box Recessed No Trim Small

Kleiner Rahmen für
Einbaugehäuse mit 1
Lichtquelle.



08.8191.00

Pre-installation frame small
single light.

Kleiner Rahmen für
Einbaugehäuse mit 2
Lichtquellen.



08.8192.00

Pre-installation frame small 2
lights.

Compass Box Recessed Small

Querabschirmung
Screening crosspiece



08.8238.14

Honeycomb
Honeycomb



08.8196.14

Compass Box Recessed No Trim Large

Grosser Rahmen für
Einbaugehäuse mit 1
Lichtquelle.



08.8187.00

Pre-installation frame large
single light.

Grosser Rahmen für
Einbaugehäuse mit 2
Lichtquellen.



08.8188.00

Pre-installation frame 2 large
lights.

Compass Box Recessed Large

Querabschirmung
Screening crosspiece



08.8034.14

Honeycomb
Honeycomb



08.8036.14

BATTERY

DESIGNED BY F.A. PORSCHE

TRIM / NO TRIM SMALL
1L / 2L / 3L / 4L SQUARE



LIGHT SOURCE
LED ARRAY
16,5W
2290 lm
3000K/CRI 80

TRIM / NO TRIM SMALL
1L / 2L



LIGHT SOURCE
LED
QR-CBC 51
GX5.3

TRIM / NO TRIM LARGE
1L / 2L



LIGHT SOURCE
LED
QR-111
G53

□ 20 Mattweiss /RAL 9016
20 Matt White

■ 08 Quecksilber/RAL 9007
08 Mercury

■ 14 Mattschwarz/RAL 9005
14 Matt Black

Battery Trim



Battery No Trim



Ist bis 40° in alle Richtungen hin schwenkbar.
Can be rotated 40° in any direction.

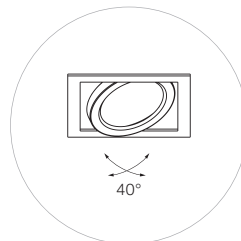

BATTERY

Produktbeschreibung

Strahlersystem mit 1, 2, 3 oder 4 schwenkbaren Lichtquellen zum Einbau in abgehängte Decken mit 1 bis 30 mm Dicke. Für LED und Niederspannungslampen. Einbaugehäuse aus mattschwarz pulverlackiertem Stahl mit Einbaurahmen aus stranggegossenem Aluminium mit Befestigungssystem für abgehängte Decken. (Battery No Trim).

Kardanischer Ausrichtmechanismus aus mattschwarz pulverlackiertem Stahl. Schwarz lackiertes Befestigungssystem mit Stahlklemmen und Sperrschraube. Ringe aus genarbtem Aluminiumdruckguss mit 3 mm starkem Stahlrahmen. Anschlussklemme für die Elektroanschlüsse über dem Leuchtmittelgehäuse.

Für LED retrofit Versionen: Hochresistenter, zusätzlicher interner Ring aus PPS zur Befestigung der Lampe und des Blendschutzes.

Reflektoren

Reflektor aus Aluminium mit silbern eloxierter Aussenfläche und mit Reinstaluminium beschichteter Innenfläche. Abschirmung aus schwarzem thermoplastischem Material für Leuchtmittel mit hoher Lichtemission.

Betriebsgerät

Vorverkabelung inbegriffen; Ausgestattet für externes Betriebsgerät.

Für LED retrofit Versionen:

- Elektronischer Transformator 20/105W, 220/240V, 50/60Hz mit "trailing edge" Dimmer.

Zubehör

- Abschirmzylinder mit eingebautem, schwarz pulverlackiertem Ausrichtgitter.
- Honeycomb.
- Elliptische Lichtstreuulinse aus 4 mm starkem Hartglas.
- Farbfilter.
- Rahmen zur Installation an abgehängten Decken (Battery No Trim).

Zusatzinformationen

Das kardanische Ausrichtsystem erlaubt einen Schwenkbereich von 40° in alle Richtungen. Schutzgrad IP20, IP23 je nach Modell. Schutzklasse I, III je nach Modell.

Qualitätszeichen

Das Gerät entspricht der europäischen technischen Norm EN60598-1 und den entsprechenden Zusatzregelungen.

Description

1, 2, 3 or 4 lamp adjustable- system, for recessed ceiling thicknesses of 1-30 mm. Suitable for use with LED lamps or very low voltage lamps.

Pressed steel and matt black, powder-coated recessed housing, extruded aluminum recessed trim frame for use with false ceiling systems. (Battery No Trim).

Steel "compass-type" adjustment mechanism, powder-coated matt black. Innovative steel bracket fixing system, painted black, with allen key locking mechanism. Die-cast aluminum knurled rings housed in a 3 mm steel frame.

Terminal block positioned on canopy housing box.

For LED retrofit versions: additional high-resistance PPS inner ring, for mounting lamp and anti-glare functions.

Reflectors

Super-pure, anodised-aluminum, silver reflectors with polished specular finish. Black thermoplastic protective ring for high luminance lamps.

Power Supply

Pre-wiring included; ready for remote power supply.

For LED retrofit versions:

- Electronic transformer 20/105W, 220/240V, 50/60Hz suitable for dimming when used with trailing edge dimmers.

Accessories

- Screening cylinder with cross baffle element incorporated, black powder-coated finish.
- Honeycomb.
- 4 mm tempered glass elliptical distribution lens.
- Chromatic filters.
- Frame needed for installation on false ceiling (Battery No Trim).

Additional Information

Compass-type adjustment system permits focusing from 0° to 40° in all directions.

IP20, IP23 protection grade depending on the versions.

Insulation class I, III depending on the versions.

Standard Compliance and Quality Marks

EN60598-1 European Technical Standards and any subsequent additions.



Trim



No Trim

BATTERY

Battery Trim Small 1L

Light Source: LED Array DC 500 mA - 16,5W - 2290 lm - 3000K/CRI 80

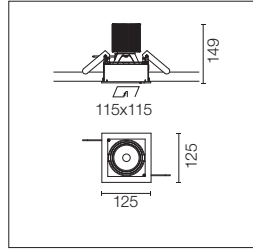

LED Einbauleuchte. Ohne Netzgerät. Recessed luminaire with LED light source. Power supply not included.

Battery No Trim Small 1L

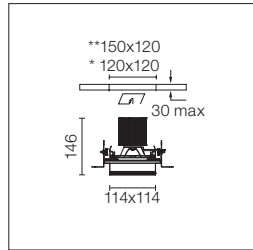

Der Rahmen für das Einbaugehäuse ist getrennt zu bestellen. Pre-installation frame must be ordered separately.

Empfohlene Netzgeräte / Recommended power supply*:
 Non Dimmable 60.9160
 Dimmable 1-10V 60.9188
 Dimmable Dali 1 60.8847
 Dimmable Dali 2 60.9222
 Mains Dimming 60.9467
 Casambi 60.9207

* Siehe Treiberkapitel / Refer to the Drivers chapter

* Zugängliche Decke: module/open. | Accessible ceiling: modular/open.
 **Nicht zugängliche Decke: | Inaccessible ceiling.

- 04.6470.20B
- 04.6470.08B
- 04.6470.14B
- 04.6470.14BNT

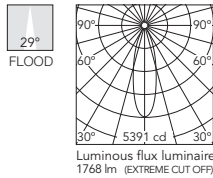

- 04.6471.20B
- 04.6471.08B
- 04.6471.14B
- 04.6471.14BNT

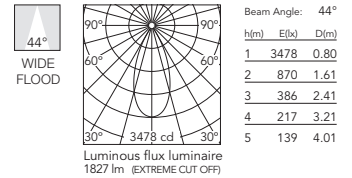

Battery Trim Small 2L

Light Source: LED Array DC 500 mA - 2x16,5W - 2x2290 lm - 3000K/CRI 80

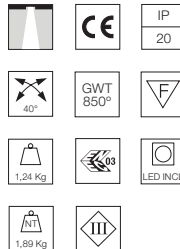
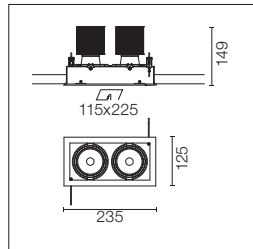

LED Einbauleuchte. Für jeden Optikkörper ist ein Netzgerät erforderlich.

Recessed luminaire with LED light source. Power supply not included. Requires one power supply for each optic body.

Battery No Trim Small 2L

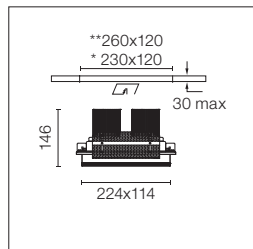

Der Rahmen für das Einbaugehäuse ist getrennt zu bestellen. Pre-installation frame must be ordered separately.

Empfohlene Netzgeräte / Recommended power supply*:
 Non Dimmable 60.9160
 Dimmable 1-10V 60.9188
 Dimmable Dali 1 60.8847
 Dimmable Dali 2 60.9222
 Mains Dimming 60.9467
 Casambi 60.9207

* Siehe Treiberkapitel / Refer to the Drivers chapter

* Zugängliche Decke: module/open. | Accessible ceiling: modular/open.
 **Nicht zugängliche Decke: | Inaccessible ceiling.

- 04.6475.20B
- 04.6475.08B
- 04.6475.14B
- 04.6475.14BNT

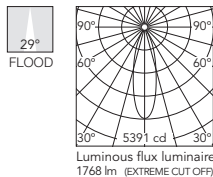

- 04.6476.20B
- 04.6476.08B
- 04.6476.14B
- 04.6476.14BNT

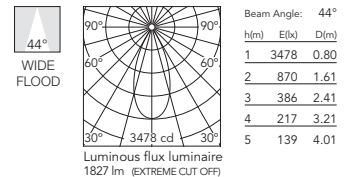

BATTERY

Battery Trim Small 3L

Light Source: LED Array DC 500 mA - 3x16,5W - 3x2290 lm - 3000K/CRI 80

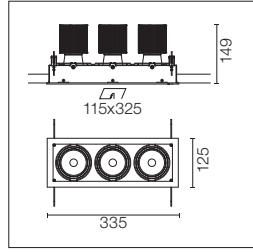

LED Einbauleuchte. Für jeden Optikkörper ist ein Netzgerät erforderlich.

Recessed luminaire with LED light source. Power supply not included. Requires one power supply for each optic body.

Battery No Trim Small 3L

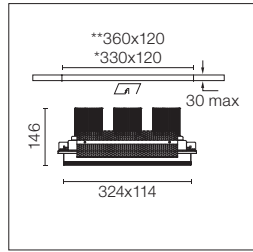

Der Rahmen für das Einbaugehäuse ist getrennt zu bestellen.

Pre-installation frame must be ordered separately.

Empfohlene Netzgeräte / Recommended power supply*:

Non Dimmable	60.9160
Dimmable 1-10V	60.9188
Dimmable Dali 1	60.8847
Dimmable Dali 2	60.9222
Mains Dimming	60.9467
Casambi	60.9207

* Siehe Treiberkapitel / Refer to the Drivers chapter

* Zugängliche Decke: module/open. | Accessible ceiling: modular/open.
**Nicht zugängliche Decke: | Inaccessible ceiling.

- 04.6480.20B
- 04.6480.08B
- 04.6480.14B
- 04.6480.14BNT

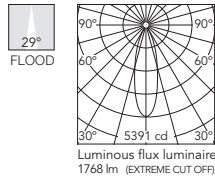

- 04.6481.20B
- 04.6481.08B
- 04.6481.14B
- 04.6481.14BNT

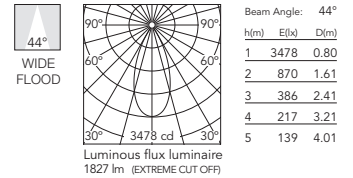

Battery Trim Small 4L Square

Light Source: LED Array DC 500 mA - 4x16,5W - 4x2290 lm - 3000K/CRI 80

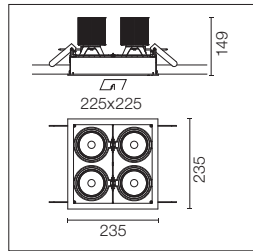

LED Einbauleuchte. Für jeden Optikkörper ist ein Netzgerät erforderlich.

Recessed luminaire with LED light source. Power supply not included. Requires one power supply for each optic body.

Battery No Trim Small 4L Square

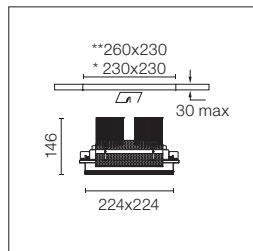

Der Rahmen für das Einbaugehäuse ist getrennt zu bestellen.

Pre-installation frame must be ordered separately.

Empfohlene Netzgeräte / Recommended power supply*:

Non Dimmable	60.9160
Dimmable 1-10V	60.9188
Dimmable Dali 1	60.8847
Dimmable Dali 2	60.9222
Mains Dimming	60.9467
Casambi	60.9207

* Siehe Treiberkapitel / Refer to the Drivers chapter

* Zugängliche Decke: module/open. | Accessible ceiling: modular/open.
**Nicht zugängliche Decke: | Inaccessible ceiling.

- 04.6485.20B
- 04.6485.08B
- 04.6485.14B
- 04.6485.14BNT

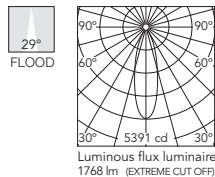

- 04.6486.20B
- 04.6486.08B
- 04.6486.14B
- 04.6486.14BNT

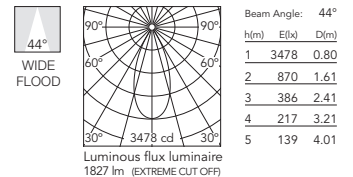

BATTERY

Battery Trim Small 1L

Light Source: LED QR-CBC 51 GX5.3

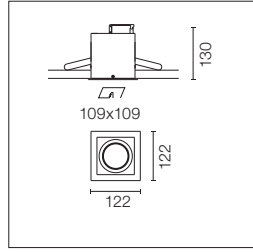

Einbauleuchte für 12 V LED-Retrofit-Lampe. Separater Transformator nicht inbegriffen.

Recessed luminaire for 12V LED Retrofit lamp. Remote transformer not included.

Zusätzlicher interner Ring aus hochresistentem Kunststoff (PPS).

Additional inner plastic (PPS) ring for lamp approaching & low glare effect.

Battery No Trim Small 1L

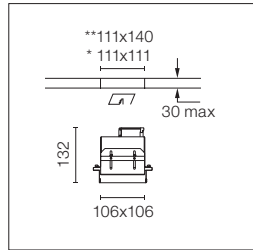

Der Rahmen für das Einbaugehäuse ist getrennt zu bestellen.

Pre-installation frame must be ordered separately.

- 04.6021.20
- 04.6021.08
- 04.6021.14

- 04.6021.20.NT
- 04.6021.08.NT
- 04.6021.14.NT

* Zugängliche Decke: module/open. | Accessible ceiling: modular/open.
 **Nicht zugängliche Decke. | Inaccessible ceiling.

Battery Trim Small 2L

Light Source: LED QR-CBC 51 GX5.3

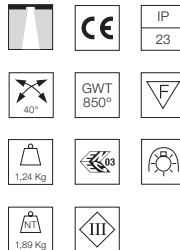
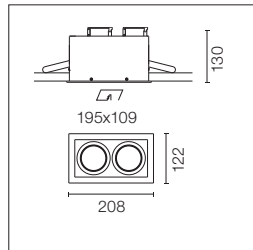

Einbauleuchte für 12 V LED-Retrofit-Lampe. Separater Transformator nicht inbegriffen.

Recessed luminaire for 12V LED Retrofit lamp. Remote transformer not included.

Zusätzlicher interner Ring aus hochresistentem Kunststoff (PPS).

Additional inner plastic (PPS) ring for lamp approaching & low glare effect.

Battery No Trim Small 2L

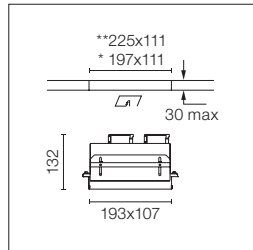

Der Rahmen für das Einbaugehäuse ist getrennt zu bestellen.

Pre-installation frame must be ordered separately.

- 04.6022.20
- 04.6022.08
- 04.6022.14

- 04.6022.20.NT
- 04.6022.08.NT
- 04.6022.14.NT

* Zugängliche Decke: module/open. | Accessible ceiling: modular/open.
 **Nicht zugängliche Decke. | Inaccessible ceiling.

BATTERY

Battery Trim Large 1L

Light Source: LED QR-111 G53

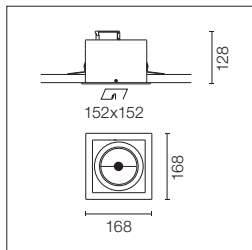

Einbauleuchte für 12 V LED-Retrofit-Lampe. Separater Transformator nicht inbegriffen.

Recessed luminaire for 12V LED Retrofit lamp. Remote transformer not included.

Battery No Trim Large 1L

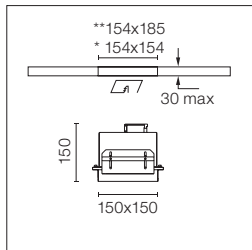

Der Rahmen für das Einbaugehäuse ist getrennt zu bestellen.

Pre-installation frame must be ordered separately.

- 04.6001.20
- 04.6001.08
- 04.6001.14
- 04.6001.20.NT
- 04.6001.08.NT
- 04.6001.14.NT

* Zugängliche Decke: module/open. | Accessible ceiling: modular/open.
 **Nicht zugängliche Decke. | Inaccessible ceiling.

Battery Trim Large 2L

Light Source: LED QR-111 G53

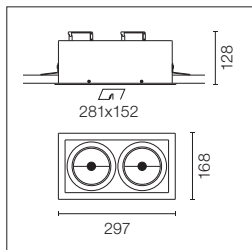

Einbauleuchte für 12 V LED-Retrofit-Lampe. Separater Transformator nicht inbegriffen.

Recessed luminaire for 12V LED Retrofit lamp. Remote transformer not included.

Battery No Trim Large 2L

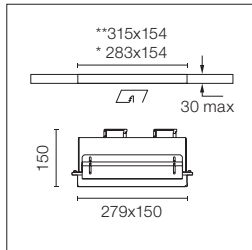

Der Rahmen für das Einbaugehäuse ist getrennt zu bestellen.

Pre-installation frame must be ordered separately.

- 04.6002.20
- 04.6002.08
- 04.6002.14
- 04.6002.20.NT
- 04.6002.08.NT
- 04.6002.14.NT

* Zugängliche Decke: module/open. | Accessible ceiling: modular/open.
 **Nicht zugängliche Decke. | Inaccessible ceiling.

BATTERY

Zubehör / Accessories

Battery No Trim: LED Array

Kleiner Rahmen für Einbaugehäuse mit 1 Lichtquelle.	Pre-installation frame small single light.		08.8523.00
---	--	---	------------

Kleiner Rahmen für Einbaugehäuse mit 2 Lichtquellen.	Pre-installation frame small 2 lights.		08.8524.00
--	--	---	------------

Kleiner Rahmen für Einbaugehäuse mit 3 Lichtquellen.	Pre-installation frame small 3 lights.		08.8525.00
--	--	---	------------

Kleiner Rahmen für Einbaugehäuse mit 4 Lichtquellen.	Pre-installation frame small 4 lights.		08.8526.00
--	--	---	------------

Battery No Trim: QR-CBC 51

Kleiner Rahmen für Einbaugehäuse mit 1 Lichtquelle.	Pre-installation frame small single light.		08.8080.00
---	--	---	------------

Kleiner Rahmen für Einbaugehäuse mit 2 Lichtquellen.	Pre-installation frame small 2 lights.		08.8081.00
--	--	--	------------

Battery No Trim: QR-111

Grosser Rahmen für Einbaugehäuse mit 1 Lichtquelle.	Pre-installation frame large single light.		08.8084.00
---	--	---	------------

Grosser Rahmen für Einbaugehäuse mit 2 Lichtquellen.	Pre-installation frame large 2 lights.		08.8085.00
--	--	--	------------

BATTERY

Zubehör / Accessories

Battery Trim / No Trim: LED Array

Honeycomb
Honeycomb  08.8495.14

Blauer filter
Blue filter  08.8503.64.OD

Hellblauer filter
Sky blue filter  08.8503.65.OD

Amber filter
Amber filter  08.8503.66.OD

Roter filter
Red filter  08.8503.67.OD

Hot light
Hot light  08.8503.69

Cold light
Cold light  08.8503.CL

Daylight
Daylight  08.8503.DL

Neodimium
Neodimium  08.8503.ND

Battery Trim / No Trim: QR-111

Elliptische linse
Elliptical lens  08.8025.20
 08.8025.08
 08.8025.14

Abschirmzylinder
Screening cylinder  08.8030.20
 08.8030.08
 08.8030.14

Honeycomb
Honeycomb  08.8029.20
 08.8029.08
 08.8029.14

Floodlinse
Flood lens  08.8180.20
 08.8180.08
 08.8180.14

Blauer filter
Blue filter  08.8027.20.AO
 08.8027.08.AO
 08.8027.14.AO

Hellblauer filter
Sky blue filter  08.8027.20.AC
 08.8027.08.AC
 08.8027.14.AC

Amber filter
Amber filter  08.8027.20.AM
 08.8027.08.AM
 08.8027.14.AM

Roter filter
Red filter  08.8027.20.RO
 08.8027.08.RO
 08.8027.14.RO

U.V. filter
U.V. filter  08.8027.20.UV
 08.8027.08.UV
 08.8027.14.UV

I.R. filter
I.R. filter  08.8027.20.IR
 08.8027.08.IR
 08.8027.14.IR

Hot light
Hot light  08.8027.20.HL
 08.8027.08.HL
 08.8027.14.HL

Cold light
Cold light  08.8027.20.CL
 08.8027.08.CL
 08.8027.14.CL

Daylight
Daylight  08.8027.20.DL
 08.8027.08.DL
 08.8027.14.DL

Neodimium
Neodimium  08.8027.20.ND
 08.8027.08.ND
 08.8027.14.ND

MICRO BATTERY

DESIGNED BY F. A. PORSCHE



OPAL			FIXED	ADJUSTABLE	
LIGHT SOURCE LED ARRAY 9,2W 1060 lm 3000K/CRI 90	LIGHT SOURCE LED PAR 16 GZ10	LIGHT SOURCE LED QR-CBC 51 GX5.3	LIGHT SOURCE LED ARRAY 9,2W 1060 lm 3000K/CRI 90	LIGHT SOURCE LED PAR 16 GZ10	LIGHT SOURCE LED QR-CBC 51 GX5.3

20 Mattweiss/RAL 9016
20 Matt White

08 Quecksilber/RAL 9007
08 Mercury

14 Mattschwarz/RAL 9005
14 Matt Black



Die Modelle "adjustable" sind bis 40° in alle Richtungen hin schwenkbar.
Adjustable versions can be swivelled 40° in any direction.

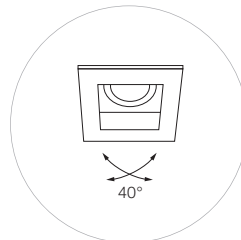

Produktbeschreibung

Einbaustrahler für Innenbereiche in starrer oder schwenkbarer Variante. Für LED, Niederspannungslampen, direkten Netzanschluss oder Metaldampflampen. Schwenkbarer Leuchtenkörper, gleichzeitig Lampenhalterung, aus schwarz pulverlackiertem Aluminiumdruckguss. Schliessring aus schwarz pulverlackiertem Aluminiumdruckguss. Lampenbefestigungsfeder aus rostfreiem Stahl. Einbaukörper zur Lampenabschirmung aus schwarz pulverlackiertem Stahl. Aussenrahmen aus lackiertem Aluminium. Befestigungssystem für abgehängte Decken bis zu 30 mm Dicke mit rostfreien Stahlklammern mit Sicherheitsschraube.

Reflektoren

Der Strahler ist nur für Leuchtmittel mit eingebautem Reflektor ausgestattet.

Betriebsgerät

Elektronischer Transformator der neuesten Generation nicht inbegriffen.
Elektronischer Transformator 20/105W, 220/240V, 50/60Hz, mit "trailing edge" Dimmer.

Zubehör

Anti-Blendungszyylinder. Abschirmung 40°. Nicht kompatibel mit LED-Versionen.

Zusatzinformationen

Das kardanische Ausrichtungssystem erlaubt einen Schwenkbereich von 40° in alle Richtungen.
Schutzgrad: IP44 für unzugängliche Decken und Strahler mit Schutzglas; IP23 für unzugängliche Decken und Strahler ohne Schutzglas.
Schutzklasse II, III je nach Modell.
Auf normal entflammaren Oberflächen einsetzbar.

Qualitätszeichen

Das Gerät entspricht der europäischen technischen Norm EN60598-1 und den entsprechenden Zusatzregelungen.

Description

Recessed indoor luminaire, adjustable or fixed. Suitable for use with LED lamps, very low voltage or direct mains power or metal halide lamps. Die-cast aluminum adjustable lamp-support with black powder-coated finish. Die-cast aluminum, black powder-coated closing ring. Stainless steel lamp fixing spring. Recessed steel body for reducing lamp visibility with black powder-coated finish. Painted aluminum outer frame. Fixing system for ceiling thicknesses 0-30 mm. with steel sprung brackets.

Reflectors

The luminaire is designed for reflector lamps only.

Power Supply

Next-generation electronic transformer not included.
20/105W, 220/240V, 50/60Hz electronic transformer suitable for dimming when used with trailing edge dimmers.

Accessories

Anti-glare cylinder. Cut-off 40°. Not compatible with LED versions.

Additional Information

Compass-type adjustment system permits focusing from 0° to 40° in all directions.
IP44 protection grade in non-accessible ceilings, for luminaires with glass cover; IP23 in non-accessible ceilings, for luminaires without glass cover.
Insulation class II, III depending on the versions.
Suitable for installation on normally inflammable surfaces.

Standard Compliance and Quality Marks

EN60598-1 European Technical Standards and any subsequent additions.

MICRO BATTERY

Micro Battery Opal Glass

Light Source: LED Array DC 500 mA - 9,2W - 1060 lm - 3000K/CRI 90

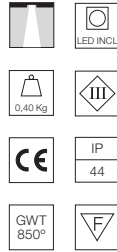
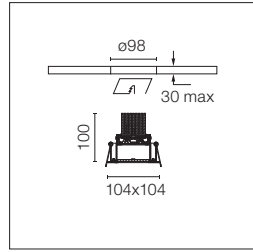

LED Einbauleuchte. Ohne Netzgerät. Recessed luminaire with LED light source. Power supply not included.

Empfohlene Netzgeräte / Recommended power supply*:

Non Dimmable	60.9160
Dimmable 1-10V	60.9188
Dimmable Dali 1	60.8847
Dimmable Dali 2	60.9222
Mains Dimming	60.9411
Casambi	60.9207

* Siehe Treiberkapitel / Refer to the Drivers chapter

- 04.6330.20B
- 04.6330.08B
- 04.6330.14B

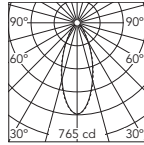

Luminous flux luminaire
581 lm (EXTREME CUT OFF)

Beam Angle: 40°

h(m)	E(lx)	D(m)
1	765	0.72
2	191	1.45
3	85	2.17
4	48	2.89
5	31	3.62

Micro Battery Opal Glass

Light Source: LED PAR 16 GZ10

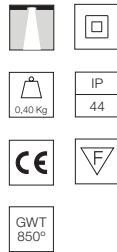
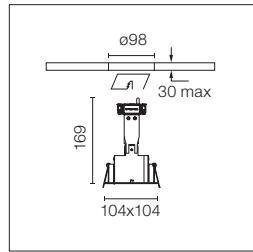

Einbauleuchte für Netzspannung für LED-Retrofit-Lampe. Recessed luminaire with main voltage source for LED Retrofit lamp.

- 04.6305.20
- 04.6305.08
- 04.6305.14

Micro Battery Opal Glass

Light Source: LED QR-CBC 51 GX5.3

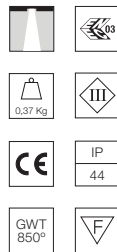
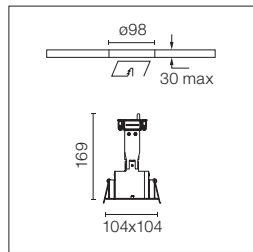

Einbauleuchte für 12 V LED-Retrofit-Lampe. Separater Transformator nicht inbegriffen. Recessed luminaire for 12V LED Retrofit lamp. Remote transformer not included.

- 04.6300.20
- 04.6300.08
- 04.6300.14

MICRO BATTERY

Micro Battery Fixed

Light Source: LED Array DC 500 mA - 9,2W - 1060 lm - 3000K/CRI 90

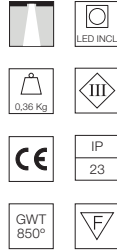
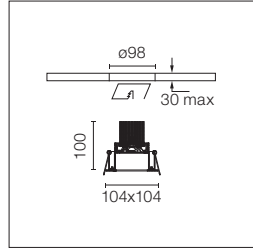

LED Einbauleuchte. Ohne Netzgerät. Recessed luminaire with LED light source. Power supply not included.

Empfohlene Netzgeräte / Recommended power supply*:

Non Dimmable	60.9160
Dimmable 1-10V	60.9188
Dimmable Dali 1	60.8847
Dimmable Dali 2	60.9222
Mains Dimming	60.9411
Casambi	60.9207

* Siehe Treiberkapitel / Refer to the Drivers chapter

- 04.6333.20B
- 04.6333.08B
- 04.6333.14B

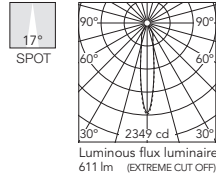

Beam Angle: 17°

h(m)	E(lx)	D(m)
1	2349	0.31
2	587	0.61
3	261	0.92
4	147	1.23
5	94	1.54

- 04.6335.20B
- 04.6335.08B
- 04.6335.14B

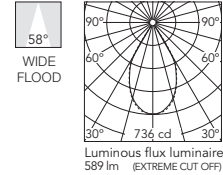

Beam Angle: 58°

h(m)	E(lx)	D(m)
1	736	1.10
2	184	2.20
3	82	3.30
4	46	4.40
5	29	5.50

- 04.6334.20B
- 04.6334.08B
- 04.6334.14B

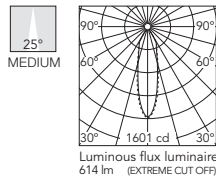

Beam Angle: 25°

h(m)	E(lx)	D(m)
1	1601	0.45
2	400	0.90
3	178	1.35
4	100	1.80
5	64	2.25

Micro Battery Fixed

Light Source: LED PAR 16 GZ10

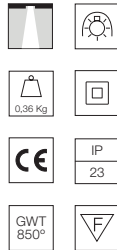
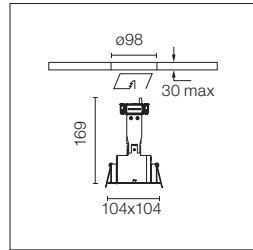

Einbauleuchte für Netzspannung für LED-Retrofit-Lampe. Recessed luminaire with main voltage source for LED Retrofit lamp.

- 04.6306.20
- 04.6306.08
- 04.6306.14

Micro Battery Fixed

Light Source: LED QR-CBC 51 GX5.3

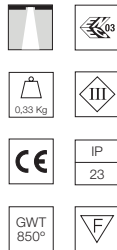
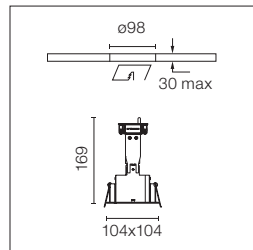

Einbauleuchte für 12 V LED-Retrofit-Lampe. Separater Transformator nicht inbegriffen. Recessed luminaire for 12V LED Retrofit lamp. Remote transformer not included.

- 04.6301.20
- 04.6301.08
- 04.6301.14

MICRO BATTERY

Micro Battery Adjustable

Light Source: LED Array DC 500 mA - 9,2W - 1060 lm - 3000K/CRI 90

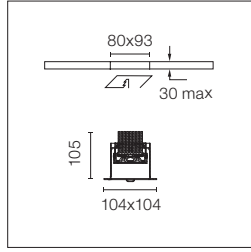
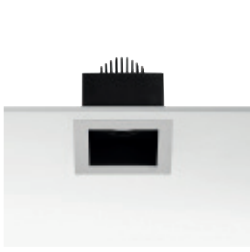

- GWT 850°
- LED INCL
- 40°
- 0,43 Kg
- CE
- IP 23
- F
- III

LED Einbauleuchte. Ohne Netzgerät. Recessed luminaire with LED light source. Power supply not included.

Empfohlene Netzgeräte / Recommended power supply*:

Non Dimmable	60.9160
Dimmable 1-10V	60.9188
Dimmable Dali 1	60.8847
Dimmable Dali 2	60.9222
Mains Dimming	60.9411
Casambi	60.9207

* Siehe Treiberkapitel / Refer to the Drivers chapter

- 04.6336.20B
- 04.6336.08B
- 04.6336.14B

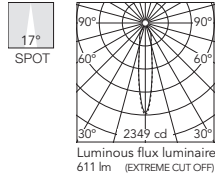

Beam Angle: 17°

h(m)	E(lx)	D(m)
1	2349	0.31
2	587	0.61
3	261	0.92
4	147	1.23
5	94	1.54

- 04.6338.20B
- 04.6338.08B
- 04.6338.14B

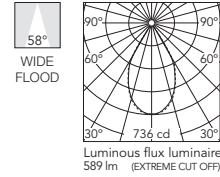

Beam Angle: 58°

h(m)	E(lx)	D(m)
1	736	1.10
2	184	2.20
3	82	3.30
4	46	4.40
5	29	5.50

- 04.6337.20B
- 04.6337.08B
- 04.6337.14B

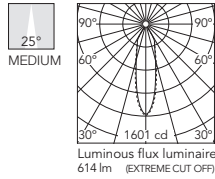

Beam Angle: 25°

h(m)	E(lx)	D(m)
1	1601	0.45
2	400	0.90
3	178	1.35
4	100	1.80
5	64	2.25

Micro Battery Adjustable

Light Source: LED PAR 16 GZ10

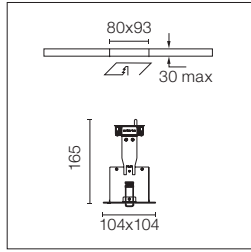

- GWT 850°
- LED INCL
- 40°
- 0,43 Kg
- CE
- IP 23
- F
- III

Einbauleuchte für Netzspannung für LED-Retrofit-Lampe. Recessed luminaire with main voltage source for LED Retrofit lamp.

- 04.6307.20
- 04.6307.08
- 04.6307.14

Micro Battery Adjustable

Light Source: LED QR-CBC 51 GX5.3

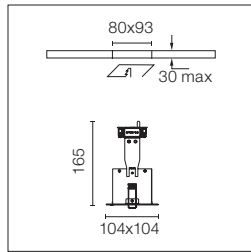

- GWT 850°
- LED INCL
- 40°
- 0,40 Kg
- CE
- IP 23
- F
- III

Einbauleuchte für 12 V LED-Retrofit-Lampe. Separater Transformator nicht inbegriffen. Recessed luminaire for 12V LED Retrofit lamp. Remote transformer not included.

- 04.6302.20
- 04.6302.08
- 04.6302.14

Zubehör / Accessories

Anti-Blendungszyylinder.
Abschirmung 40°. Nicht kompatibel mit LED-Versionen.

Anti-glare cylinder. Cut-off 40°. Not compatible with LED versions.



- 08.8270.14

SPOTLIGHTS

Camera, Find Me, UT Spot&Pro,
Solid Pure, Pure Spot, Wan Spot,
Fort Knox.

CAMERA

DESIGNED BY KNUD HOLSCHER

IN-TRACK

CAMERA
60



LIGHT SOURCE
LED ARRAY
Up to 20W
3000K/CRI 97
Up to 1260 lm
3500K/CRI 97
Up to 1355 lm

CAMERA
90



LIGHT SOURCE
LED ARRAY
Up to 32W
3000K/CRI 97
Up to 2585 lm
3500K/CRI 97
Up to 2715 lm

GA-69

CAMERA
60



LIGHT SOURCE
LED ARRAY
Up to 20W
3000K/CRI 97
Up to 1260 lm
3500K/CRI 97
Up to 1355 lm

CAMERA
90



LIGHT SOURCE
LED ARRAY
Up to 32W
3000K/CRI 97
Up to 2585 lm
3500K/CRI 97
Up to 2715 lm

WA Texturiertes Weiss
WA Textured White

DR Anthrazit
DR Anthracite



CAMERA

Produktbeschreibung

Innenleuchte für die Installation an dreiphasiger Schiene, mit leistungsstarken LED-Lichtquellen und als dimmbare und nicht dimmbare Version erhältlich. Diese Produktgruppe ist in zwei Größen erhältlich (60 und 90).

Das optische Gehäuse der Leuchte ist das Ergebnis einer gründlichen optischen Recherche. Doppelte Fokulinse, die speziell für diese Produkte von FLOS entwickelt wurde. Sie garantiert die maximale optische Kontrolle und eine außergewöhnliche Homogenität des Lichtstrahls. Camera nutzt die Vorteile einer innovativen, mikrostrukturierten Silikonlinse, die eine gute Kontrolle erlaubt und für absolute Effizienz, Hitzebeständigkeit und maximale Qualität bei der Lichtverteilung sorgt. Sie beinhaltet ein LED Array mit einer innovativen Lichtprojektionsbearbeitung, die eine sehr enge Optik und Allgemeinbeleuchtung ermöglicht. Vollständig integrierter "cut-off"-Dimmer.

Das optische Set beinhaltet 5 unterschiedliche Lichtstrahlöffnungen, von denen jede einzelne für eine besondere Anwendung entwickelt wurde. Ob intensiver Lichtstrahl oder Streulichteffekt, die optische Steuerung ist stets außergewöhnlich und es kommt zu keinem Lichtabfall.

Betriebsgerät

Stromversorgung mittels Konstantstrom, in nicht dimmbarer oder dimmbarer Version mittels eingebautem Potentiometer, Dali und Casambi.

Für die Steuerung mittels Casambi (maximal 200 Leuchten) müssen Casambi-Leuchten bestellt werden. Für Mobilgeräte ist die app FLOS Control® powered by Casambi erforderlich (erhältlich im Apple Store und auf Google Play).

Zubehör

- Honeycomb verfügbar.

Qualitätszeichen

Das Gerät entspricht der europäischen technischen Norm EN60598-1 und den entsprechenden Zusatzregelungen.

Description

Luminaire for indoor use to be mounted on three phase track, available in LED technology light sources and in dimmable and non-dimmable versions.

The family is available in two sizes (60 / 90).

The optical housing of the luminaire is the result of a careful optical research. Dual focus lens specifically developed by FLOS for these products. Ensures maximum optical control and exceptionally even light beams.

Camera takes advantage of an innovative micro-textured silicone lens that allows extreme control as well as providing absolute efficiency, heat resistance and maximum quality in light distribution.

It incorporates an LED Array with an innovative light projection treatment that allows very narrow optics and general lighting. Integrated full cut-off.

The optical kit available includes 5 differentiated beam openings, each developed for a specific target application. Whether it's intensive beams or diffused light effects, optical control is always exceptional and fall-off is totally absent.

Power Supply

Not dimmable or dimmable 220-240V, constant current, power supply included. Dimmable versions are available with DALI, Casambi or come with a built-in Potentiometer.

For Casambi management (Max. 200 luminaires) it is mandatory to use fixtures in the Casambi version.

For managing and controlling the Casambi system, the FLOS Control® app powered by Casambi for mobile devices is required (available in the Apple Store and Google Play).

Accessories

- Honeycomb available.

Standard Compliance and Quality Marks

EN60598-1 European Technical Standards and any subsequent additions.

FLOS
CONTROL BY CASAMBI



CAMERA

Camera 60

Light Source: Super Spot: LED Array 13W - 750 lm - 3000K/CRI 97 / 13W - 780 lm - 3500K/CRI 97
S/M/F/WF: LED Array 20W - 1260 lm - 3000K/CRI 97 / 20W - 1355 lm - 3500K/CRI 97

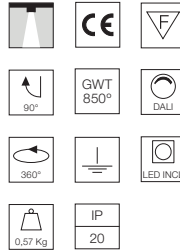
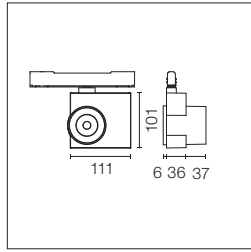

Projektor für die Installation in einer dreiphasigen Schiene mit LED-Lichtquelle. Stromversorgung: 220-240 V, 50-60 Hz. Zur Installation mit den Tracking Power-Profilen.

Spotlight to be installed on 3-phase track with LED light source. 220-240V, 50-60Hz power supply integrated. To be used with The Tracking Power profiles.

Optic Super Spot 3000K

- Non Dimmable
- 09.8100.WA
- 09.8100.DR
- Potentiometer
- 09.8100.WA.PC
- 09.8100.DR.PC
- *Casambi integrated
- 09.8100.WA.CB
- 09.8100.DR.CB

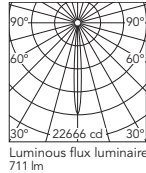

Beam Angle: 9°

h(m)	E lx	D(m)
1	22666	0.16
2	5667	0.32
3	2518	0.48
4	1417	0.63
5	907	0.79

Luminous flux luminaire 711 lm

Optic Super Spot 3500K

- Non Dimmable
- 09.8105.WA
- 09.8105.DR
- Potentiometer
- 09.8105.WA.PC
- 09.8105.DR.PC
- *Casambi integrated
- 09.8105.WA.CB
- 09.8105.DR.CB

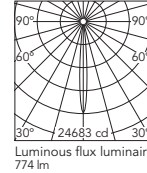

Beam Angle: 9°

h(m)	E lx	D(m)
1	24683	0.16
2	6171	0.32
3	2743	0.48
4	1543	0.63
5	987	0.79

Luminous flux luminaire 774 lm

Optic Spot 3000K

- Non Dimmable
- 09.8101.WA
- 09.8101.DR
- Potentiometer
- 09.8101.WA.PC
- 09.8101.DR.PC
- *Casambi integrated
- 09.8101.WA.CB
- 09.8101.DR.CB

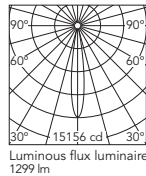

Beam Angle: 15°

h(m)	E lx	D(m)
1	15156	0.27
2	3789	0.54
3	1684	0.81
4	947	1.09
5	606	1.36

Luminous flux luminaire 1299 lm

Optic Spot 3500K

- Non Dimmable
- 09.8106.WA
- 09.8106.DR
- Potentiometer
- 09.8106.WA.PC
- 09.8106.DR.PC
- *Casambi integrated
- 09.8106.WA.CB
- 09.8106.DR.CB

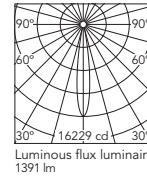

Beam Angle: 15°

h(m)	E lx	D(m)
1	16229	0.27
2	4057	0.54
3	1803	0.81
4	1014	1.09
5	649	1.36

Luminous flux luminaire 1391 lm

Optic Medium 3000K

- Non Dimmable
- 09.8102.WA
- 09.8102.DR
- Potentiometer
- 09.8102.WA.PC
- 09.8102.DR.PC
- *Casambi integrated
- 09.8102.WA.CB
- 09.8102.DR.CB

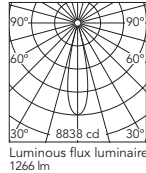

Beam Angle: 23°

h(m)	E lx	D(m)
1	8838	0.41
2	2210	0.81
3	982	1.22
4	552	1.62
5	354	2.03

Luminous flux luminaire 1266 lm

Optic Medium 3500K

- Non Dimmable
- 09.8107.WA
- 09.8107.DR
- Potentiometer
- 09.8107.WA.PC
- 09.8107.DR.PC
- *Casambi integrated
- 09.8107.WA.CB
- 09.8107.DR.CB

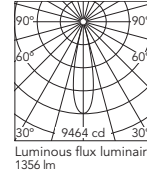

Beam Angle: 23°

h(m)	E lx	D(m)
1	9464	0.41
2	2366	0.81
3	1052	1.22
4	591	1.62
5	379	2.03

Luminous flux luminaire 1356 lm

Optic Flood 3000K

- Non Dimmable
- 09.8103.WA
- 09.8103.DR
- Potentiometer
- 09.8103.WA.PC
- 09.8103.DR.PC
- *Casambi integrated
- 09.8103.WA.CB
- 09.8103.DR.CB

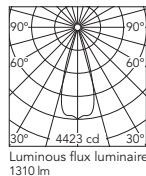

Beam Angle: 34°

h(m)	E lx	D(m)
1	4423	0.61
2	1106	1.21
3	491	1.82
4	276	2.42
5	177	3.03

Luminous flux luminaire 1310 lm

Optic Flood 3500K

- Non Dimmable
- 09.8108.WA
- 09.8108.DR
- Potentiometer
- 09.8108.WA.PC
- 09.8108.DR.PC
- *Casambi integrated
- 09.8108.WA.CB
- 09.8108.DR.CB

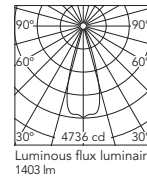

Beam Angle: 34°

h(m)	E lx	D(m)
1	4736	0.61
2	1184	1.21
3	526	1.82
4	296	2.42
5	189	3.03

Luminous flux luminaire 1403 lm

Optic Wide Flood 3000K

- Non Dimmable
- 09.8104.WA
- 09.8104.DR
- Potentiometer
- 09.8104.WA.PC
- 09.8104.DR.PC
- *Casambi integrated
- 09.8104.WA.CB
- 09.8104.DR.CB

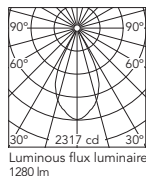

Beam Angle: 50°

h(m)	E lx	D(m)
1	2317	0.94
2	579	1.89
3	257	2.83
4	145	3.77
5	93	4.72

Luminous flux luminaire 1280 lm

Optic Wide Flood 3500K

- Non Dimmable
- 09.8109.WA
- 09.8109.DR
- Potentiometer
- 09.8109.WA.PC
- 09.8109.DR.PC
- *Casambi integrated
- 09.8109.WA.CB
- 09.8109.DR.CB

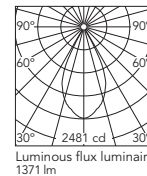

Beam Angle: 50°

h(m)	E lx	D(m)
1	2481	0.94
2	620	1.89
3	276	2.83
4	155	3.77
5	99	4.72

Luminous flux luminaire 1371 lm

* Die Steuerung bei den Casambi-Leuchten erfolgt direkt und individuell kabellos mittels der App FLOS Control® powered by Casambi / The control system with the Casambi version of light fixtures is directly and individually regulated wirelessly using the application FLOS Control® by Casambi.

CAMERA

Camera 90

Light Source: Super Spot: LED Array 20W - 1515 lm - 3000K/CRI 97 / 20W - 1625 lm - 3500K/CRI 97
S/M/F/WF: LED Array 32W - 2585 lm - 3000K/CRI 97 / 32W - 2715 lm - 3500K/CRI 97

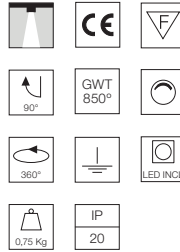
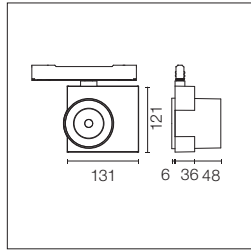

Projektor für die Installation in einer dreiphasigen Schiene mit LED-Lichtquelle. Stromversorgung: 220-240 V, 50-60 Hz. Zur Installation mit den Tracking Power-Profilen.

Spotlight to be installed on 3-phase track with LED light source. 220-240V, 50-60Hz power supply integrated. To be used with The Tracking Power profiles.

Optic Super Spot 3000K

- Non Dimmable
- 09.8200.WA
- 09.8200.DR
- Potentiometer
- 09.8200.WA.PC
- 09.8200.DR.PC
- *Casambi integrated
- 09.8200.WA.CB
- 09.8200.DR.CB

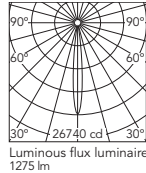

Beam Angle: 11°

h(m)	E(lx)	D(m)
1	26740	0.20
2	6685	0.39
3	2971	0.59
4	1671	0.78
5	1070	0.98

Optic Super Spot 3500K

- Non Dimmable
- 09.8205.WA
- 09.8205.DR
- Potentiometer
- 09.8205.WA.PC
- 09.8205.DR.PC
- *Casambi integrated
- 09.8205.WA.CB
- 09.8205.DR.CB

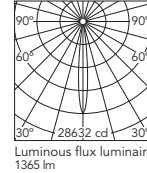

Beam Angle: 11°

h(m)	E(lx)	D(m)
1	32766	0.20
2	7158	0.39
3	3181	0.59
4	1789	0.78
5	1145	0.98

Optic Spot 3000K

- Non Dimmable
- 09.8201.WA
- 09.8201.DR
- Potentiometer
- 09.8201.WA.PC
- 09.8201.DR.PC
- *Casambi integrated
- 09.8201.WA.CB
- 09.8201.DR.CB

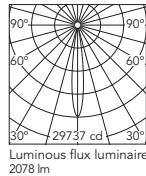

Beam Angle: 14°

h(m)	E(lx)	D(m)
1	29737	0.25
2	7434	0.49
3	3304	0.74
4	1859	0.99
5	1189	1.24

Optic Spot 3500K

- Non Dimmable
- 09.8206.WA
- 09.8206.DR
- Potentiometer
- 09.8206.WA.PC
- 09.8206.DR.PC
- *Casambi integrated
- 09.8206.WA.CB
- 09.8206.DR.CB

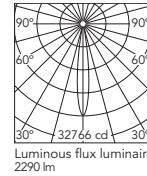

Beam Angle: 14°

h(m)	E(lx)	D(m)
1	32766	0.25
2	8192	0.49
3	3641	0.74
4	2048	0.99
5	1311	1.24

Optic Medium 3000K

- Non Dimmable
- 09.8202.WA
- 09.8202.DR
- Potentiometer
- 09.8202.WA.PC
- 09.8202.DR.PC
- *Casambi integrated
- 09.8202.WA.CB
- 09.8202.DR.CB

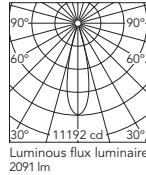

Beam Angle: 25°

h(m)	E(lx)	D(m)
1	11192	0.45
2	2798	0.90
3	1244	1.35
4	700	1.80
5	448	2.25

Optic Medium 3500K

- Non Dimmable
- 09.8207.WA
- 09.8207.DR
- Potentiometer
- 09.8207.WA.PC
- 09.8207.DR.PC
- *Casambi integrated
- 09.8207.WA.CB
- 09.8207.DR.CB

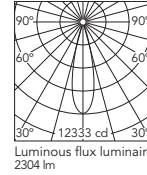

Beam Angle: 25°

h(m)	E(lx)	D(m)
1	12333	0.45
2	3083	0.90
3	1370	1.35
4	771	1.80
5	493	2.25

Optic Flood 3000K

- Non Dimmable
- 09.8203.WA
- 09.8203.DR
- Potentiometer
- 09.8203.WA.PC
- 09.8203.DR.PC
- *Casambi integrated
- 09.8203.WA.CB
- 09.8203.DR.CB

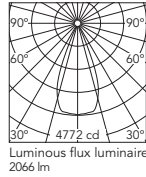

Beam Angle: 43°

h(m)	E(lx)	D(m)
1	4772	0.78
2	1193	1.56
3	530	2.34
4	298	3.12
5	191	3.90

Optic Flood 3500K

- Non Dimmable
- 09.8208.WA
- 09.8208.DR
- Potentiometer
- 09.8208.WA.PC
- 09.8208.DR.PC
- *Casambi integrated
- 09.8208.WA.CB
- 09.8208.DR.CB

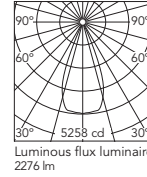

Beam Angle: 43°

h(m)	E(lx)	D(m)
1	5258	0.78
2	1315	1.56
3	584	2.34
4	329	3.12
5	210	3.90

Optic Wide Flood 3000K

- Non Dimmable
- 09.8204.WA
- 09.8204.DR
- Potentiometer
- 09.8204.WA.PC
- 09.8204.DR.PC
- *Casambi integrated
- 09.8204.WA.CB
- 09.8204.DR.CB

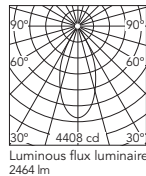

Beam Angle: 46°

h(m)	E(lx)	D(m)
1	4408	0.84
2	1101	1.68
3	490	2.52
4	276	3.36
5	177	4.19

Optic Wide Flood 3500K

- Non Dimmable
- 09.8209.WA
- 09.8209.DR
- Potentiometer
- 09.8209.WA.PC
- 09.8209.DR.PC
- *Casambi integrated
- 09.8209.WA.CB
- 09.8209.DR.CB

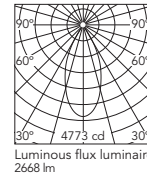

Beam Angle: 46°

h(m)	E(lx)	D(m)
1	4773	0.84
2	1193	1.68
3	531	2.52
4	299	3.36
5	192	4.19

* Die Steuerung bei den Casambi-Leuchten erfolgt direkt und individuell kabellos mittels der App FLOS Control® powered by Casambi / The control system with the Casambi version of light fixtures is directly and individually regulated wirelessly using the application FLOS Control® by Casambi.

CAMERA

Camera 60 GA-69 (Dali GAC-600)

Light Source: Super Spot: LED Array 13W - 750 lm - 3000K/CRI 97 / 12W - 780 lm - 3500K/CRI 97
S/M/F/WF: LED Array 20W - 1260 lm - 3000K/CRI 97 / 20W - 1355 lm - 3500K/CRI 97

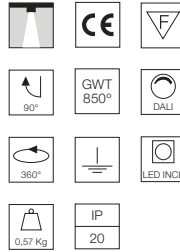
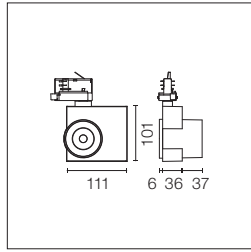

Projektor für die Installation in einer dreiphasigen Schiene mit LED-Lichtquelle. Stromversorgung: 220-240 V, 50-60 Hz. Für die DALI-Version benötigen Sie dimmbare Schienen (siehe Kapitel "Tracks").

Spotlight to be installed on 3-phase track with LED light source. 220-240V, 50-60Hz power supply integrated. DALI version requires dimmable tracks (please refer to the "Tracks" chapter).

Optic Super Spot 3000K

- Non Dimmable
 09.8110.WA
 09.8110.DR
 Dali Version
 09.8110.WA.DA
 09.8110.DR.DA
 Potentiometer
 09.8110.WA.PC
 09.8110.DR.PC
 *Casambi integrated
 09.8110.WA.CB
 09.8110.DR.CB

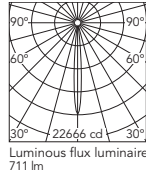

Beam Angle: 9°

h(m)	E(lx)	D(m)
1	22666	0.16
2	5667	0.32
3	2518	0.48
4	1417	0.63
5	907	0.79

Luminous flux luminaire 711 lm

Optic Super Spot 3500K

- Non Dimmable
 09.8115.WA
 09.8115.DR
 Dali Version
 09.8115.WA.DA
 09.8115.DR.DA
 Potentiometer
 09.8115.WA.PC
 09.8115.DR.PC
 *Casambi integrated
 09.8115.WA.CB
 09.8115.DR.CB

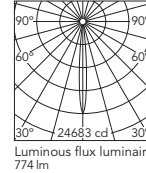

Beam Angle: 9°

h(m)	E(lx)	D(m)
1	24683	0.16
2	6171	0.32
3	2743	0.48
4	1543	0.63
5	987	0.79

Luminous flux luminaire 774 lm

Optic Spot 3000K

- Non Dimmable
 09.8111.WA
 09.8111.DR
 Dali Version
 09.8111.WA.DA
 09.8111.DR.DA
 Potentiometer
 09.8111.WA.PC
 09.8111.DR.PC
 *Casambi integrated
 09.8111.WA.CB
 09.8111.DR.CB

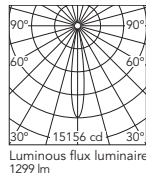

Beam Angle: 15°

h(m)	E(lx)	D(m)
1	15156	0.27
2	3789	0.54
3	1684	0.81
4	947	1.09
5	606	1.36

Luminous flux luminaire 1299 lm

Optic Spot 3500K

- Non Dimmable
 09.8116.WA
 09.8116.DR
 Dali Version
 09.8116.WA.DA
 09.8116.DR.DA
 Potentiometer
 09.8116.WA.PC
 09.8116.DR.PC
 *Casambi integrated
 09.8116.WA.CB
 09.8116.DR.CB

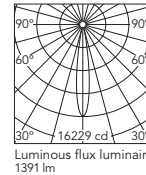

Beam Angle: 15°

h(m)	E(lx)	D(m)
1	16229	0.27
2	4057	0.54
3	1803	0.81
4	1014	1.09
5	649	1.36

Luminous flux luminaire 1391 lm

Optic Medium 3000K

- Non Dimmable
 09.8112.WA
 09.8112.DR
 Dali Version
 09.8112.WA.DA
 09.8112.DR.DA
 Potentiometer
 09.8112.WA.PC
 09.8112.DR.PC
 *Casambi integrated
 09.8112.WA.CB
 09.8112.DR.CB

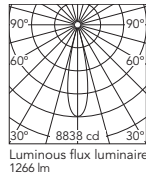

Beam Angle: 23°

h(m)	E(lx)	D(m)
1	8838	0.41
2	2210	0.81
3	982	1.22
4	552	1.62
5	354	2.03

Luminous flux luminaire 1266 lm

Optic Medium 3500K

- Non Dimmable
 09.8117.WA
 09.8117.DR
 Dali Version
 09.8117.WA.DA
 09.8117.DR.DA
 Potentiometer
 09.8117.WA.PC
 09.8117.DR.PC
 *Casambi integrated
 09.8117.WA.CB
 09.8117.DR.CB

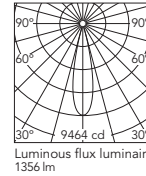

Beam Angle: 23°

h(m)	E(lx)	D(m)
1	9464	0.41
2	2366	0.81
3	1052	1.22
4	591	1.62
5	379	2.03

Luminous flux luminaire 1356 lm

Optic Flood 3000K

- Non Dimmable
 09.8113.WA
 09.8113.DR
 Dali Version
 09.8113.WA.DA
 09.8113.DR.DA
 Potentiometer
 09.8113.WA.PC
 09.8113.DR.PC
 *Casambi integrated
 09.8113.WA.CB
 09.8113.DR.CB

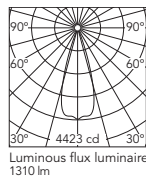

Beam Angle: 34°

h(m)	E(lx)	D(m)
1	4423	0.61
2	1106	1.21
3	491	1.82
4	276	2.42
5	177	3.03

Luminous flux luminaire 1310 lm

Optic Flood 3500K

- Non Dimmable
 09.8118.WA
 09.8118.DR
 Dali Version
 09.8118.WA.DA
 09.8118.DR.DA
 Potentiometer
 09.8118.WA.PC
 09.8118.DR.PC
 *Casambi integrated
 09.8118.WA.CB
 09.8118.DR.CB

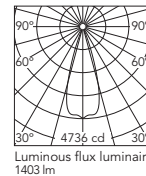

Beam Angle: 34°

h(m)	E(lx)	D(m)
1	4736	0.61
2	1184	1.21
3	526	1.82
4	296	2.42
5	189	3.03

Luminous flux luminaire 1403 lm

* Die Steuerung bei den Casambi-Leuchten erfolgt direkt und individuell kabellos mittels der App FLOS Control® powered by Casambi / The control system with the Casambi version of light fixtures is directly and individually regulated wirelessly using the application FLOS Control® by Casambi.

CAMERA

Optic Wide Flood 3000K

Non Dimmable
09.8114.WA
09.8114.DR

Dali Version

09.8114.WA.DA
09.8114.DR.DA

Potentiometer

09.8114.WA.PC
09.8114.DR.PC

*Casambi integrated

09.8114.WA.CB
09.8114.DR.CB

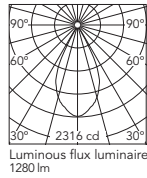

Beam Angle: 50°

h(m)	E(lx)	D(m)
1	2316	0.94
2	579	1.89
3	257	2.83
4	145	3.77
5	92	4.72

Optic Wide Flood 3500K

Non Dimmable
09.8119.WA
09.8119.DR

Dali Version

09.8119.WA.DA
09.8119.DR.DA

Potentiometer

09.8119.WA.PC
09.8119.DR.PC

*Casambi integrated

09.8119.WA.CB
09.8119.DR.CB

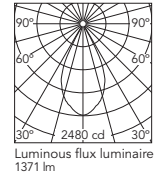

Beam Angle: 50°

h(m)	E(lx)	D(m)
1	2480	0.94
2	620	1.89
3	276	2.83
4	155	3.77
5	99	4.72

* Die Steuerung bei den Casambi-Leuchten erfolgt direkt und individuell kabellos mittels der App FLOS Control® powered by Casambi / The control system with the Casambi version of light fixtures is directly and individually regulated wirelessly using the application FLOS Control® by Casambi.

CAMERA

Camera 90 GA-69 (Dali GAC-600)

Light Source: Super Spot: LED Array 20W - 1515 lm - 3000K/CRI 97 / 20W - 1625 lm - 3500K/CRI 97
S/M/F/WF: LED Array 32W - 2585 lm - 3000K/CRI 97 / 32W - 2715 lm - 3500K/CRI 97

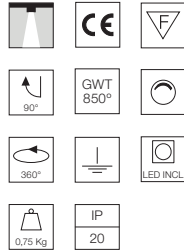
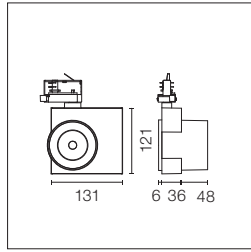

Projektor für die Installation in einer dreiphasigen Schiene mit LED-Lichtquelle. Stromversorgung: 220–240 V, 50–60 Hz. Für die DALI-Version benötigen Sie dimmbare Schienen (siehe Kapitel "Tracks").

Spotlight to be installed on 3-phase track with LED light source. 220–240V, 50–60Hz power supply integrated. DALI version requires dimmable tracks (please refer to the "Tracks" chapter).

Optic Super Spot 3000K

- Non Dimmable
- 09.8210.WA
- 09.8210.DR
- Dali Version
- 09.8210.WA.DA
- 09.8210.DR.DA
- Potentiometer
- 09.8210.WA.PC
- 09.8210.DR.PC
- *Casambi integrated
- 09.8210.WA.CB
- 09.8210.DR.CB

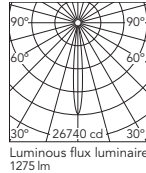

Beam Angle: 11°

h(m)	E(lx)	D(m)
1	26740	0.20
2	6685	0.39
3	2971	0.59
4	1671	0.78
5	1070	0.98

Optic Super Spot 3500K

- Non Dimmable
- 09.8215.WA
- 09.8215.DR
- Dali Version
- 09.8215.WA.DA
- 09.8215.DR.DA
- Potentiometer
- 09.8215.WA.PC
- 09.8215.DR.PC
- *Casambi integrated
- 09.8215.WA.CB
- 09.8215.DR.CB

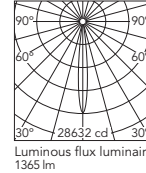

Beam Angle: 11°

h(m)	E(lx)	D(m)
1	28632	0.20
2	7158	0.39
3	3181	0.59
4	1789	0.78
5	1145	0.98

Optic Spot 3000K

- Non Dimmable
- 09.8211.WA
- 09.8211.DR
- Dali Version
- 09.8211.WA.DA
- 09.8211.DR.DA
- Potentiometer
- 09.8211.WA.PC
- 09.8211.DR.PC
- *Casambi integrated
- 09.8211.WA.CB
- 09.8211.DR.CB

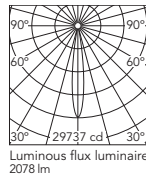

Beam Angle: 14°

h(m)	E(lx)	D(m)
1	29737	0.25
2	7434	0.49
3	3304	0.74
4	1859	0.99
5	1189	1.24

Optic Spot 3500K

- Non Dimmable
- 09.8216.WA
- 09.8216.DR
- Dali Version
- 09.8216.WA.DA
- 09.8216.DR.DA
- Potentiometer
- 09.8216.WA.PC
- 09.8216.DR.PC
- *Casambi integrated
- 09.8216.WA.CB
- 09.8216.DR.CB

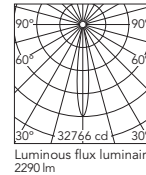

Beam Angle: 14°

h(m)	E(lx)	D(m)
1	32766	0.25
2	8192	0.49
3	3641	0.74
4	2048	0.99
5	1311	1.24

Optic Medium 3000K

- Non Dimmable
- 09.8212.WA
- 09.8212.DR
- Dali Version
- 09.8212.WA.DA
- 09.8212.DR.DA
- Potentiometer
- 09.8212.WA.PC
- 09.8212.DR.PC
- *Casambi integrated
- 09.8212.WA.CB
- 09.8212.DR.CB

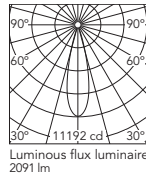

Beam Angle: 25°

h(m)	E(lx)	D(m)
1	11192	0.45
2	2798	0.90
3	1244	1.35
4	700	1.80
5	448	2.25

Optic Medium 3500K

- Non Dimmable
- 09.8217.WA
- 09.8217.DR
- Dali Version
- 09.8217.WA.DA
- 09.8217.DR.DA
- Potentiometer
- 09.8217.WA.PC
- 09.8217.DR.PC
- *Casambi integrated
- 09.8217.WA.CB
- 09.8217.DR.CB

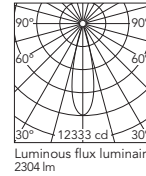

Beam Angle: 25°

h(m)	E(lx)	D(m)
1	12333	0.45
2	3083	0.90
3	1370	1.35
4	771	1.80
5	493	2.25

Optic Flood 3000K

- Non Dimmable
- 09.8213.WA
- 09.8213.DR
- Dali Version
- 09.8213.WA.DA
- 09.8213.DR.DA
- Potentiometer
- 09.8213.WA.PC
- 09.8213.DR.PC
- *Casambi integrated
- 09.8213.WA.CB
- 09.8213.DR.CB

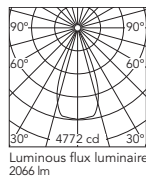

Beam Angle: 43°

h(m)	E(lx)	D(m)
1	4772	0.78
2	1193	1.56
3	530	2.34
4	298	3.12
5	191	3.90

Optic Flood 3500K

- Non Dimmable
- 09.8218.WA
- 09.8218.DR
- Dali Version
- 09.8218.WA.DA
- 09.8218.DR.DA
- Potentiometer
- 09.8218.WA.PC
- 09.8218.DR.PC
- *Casambi integrated
- 09.8218.WA.CB
- 09.8218.DR.CB

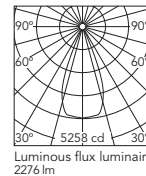

Beam Angle: 43°

h(m)	E(lx)	D(m)
1	5258	0.78
2	1315	1.56
3	584	2.34
4	329	3.12
5	210	3.90

* Die Steuerung bei den Casambi-Leuchten erfolgt direkt und individuell kabellos mittels der App FLOS Control® powered by Casambi / The control system with the Casambi version of light fixtures is directly and individually regulated wirelessly using the application FLOS Control® by Casambi.

CAMERA

Optic Wide Flood 3000K

Non Dimmable

09.8214.WA

09.8214.DR

Dali Version

09.8214.WA.DA

09.8214.DR.DA

Potentiometer

09.8214.WA.PC

09.8214.DR.PC

*Casambi integrated

09.8214.WA.CB

09.8214.DR.CB

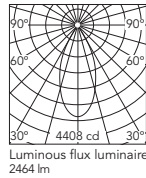

Beam Angle: 46°

h(m) E(lx) D(m)

1 4408 0.84

2 1101 1.68

3 490 2.52

4 276 3.36

5 177 4.19

Optic Wide Flood 3500K

Non Dimmable

09.8219.WA

09.8219.DR

Dali Version

09.8219.WA.DA

09.8219.DR.DA

Potentiometer

09.8219.WA.PC

09.8219.DR.PC

*Casambi integrated

09.8219.WA.CB

09.8219.DR.CB

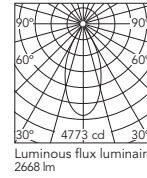

Beam Angle: 46°

h(m) E(lx) D(m)

1 4773 0.84

2 1193 1.68

3 531 2.52

4 299 3.36

5 192 4.19

Zubehör / Accessories

Camera 60

Honeycomb

Honeycomb



Super Spot / Spot

08.0175.14

Medium / Flood / Wide Flood

08.0176.14

Camera 90

Honeycomb

Honeycomb



Super Spot / Spot

08.0177.14

Medium / Flood / Wide Flood

08.0178.14

* Die Steuerung bei den Casambi-Leuchten erfolgt direkt und individuell kabellos mittels der App FLOS Control® powered by Casambi / The control system with the Casambi version of light fixtures is directly and individually regulated wirelessly using the application FLOS Control® by Casambi.

FIND ME

DESIGNED BY JORGE HERRERA

FIND ME 0
TRIM / NO TRIM



LIGHT SOURCE
POWER LED
3,5W
300 lm
2700K/CRI 90
325 lm
3000K/CRI 90

FIND ME 1
TRIM / NO TRIM



LIGHT SOURCE
POWER LED
6W
560 lm
2700K/CRI 90
600 lm
3000K/CRI 90

FIND ME 1
SUSPENSION



FIND ME 2
TRIM / NO TRIM



LIGHT SOURCE
POWER LED
10W
860 lm
2700K/CRI 90
900 lm
3000K/CRI 90

□ 30 Weiss
30 White

■ 06 Chrom
06 Chrome

■ 14 Schwarz
14 Black

Mono Point



Suspension



Abschirmkegel-Farben (inbegriffen)
Screening Cylinder Colours (included)

■ Orange
Orange

■ Violett
Violet

■ Schwarz
Black



Drehbar um 360° und schwenkbar 70°.
Can be rotated 360° and swivelled 70°.

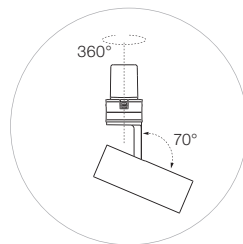

reddot design award
winner 2013

FIND ME

Produktbeschreibung

Strahlerfamilie für Innenräume zur einfachen Montage in Gipskartondecken mit einem oder zwei LED-Lichtmodulen.

Die Leuchte ist in folgenden Versionen erhältlich: Mono Point, Double Point und Suspension.

Die Mono Point Version wird mit einem zylinderförmigen Einbaurahmen geliefert, auf dem das Beleuchtungsmodul installiert wird. Dieses Modul dient in der oberen Position als Downlight und verwandelt sich in der unteren Position in einen schwenkbaren Strahler.

Mono Point wird mit einem Rahmen geliefert, der je nachdem, ob Trim- oder No-Trim-Ausführung gewünscht ist, angebracht oder weggelassen werden kann.

Die Version Double Point wird mit einem Rahmen aus thermoplastischem Einspritzmaterial geliefert, in dem zwei Beleuchtungsmodule installiert werden. Wie auch bei der Mono Point Version lassen sich die Module ausrichten und der Rahmen bietet die Möglichkeit, das Produkt so weit aufzunehmen, dass nur noch das Ende davon sichtbar ist. Die Suspension Version ist eine Variante der Mono Point Ausführung, die abhängig montiert wird.

Reflektoren

Die Leuchte wird mit der Optik accent lighting geliefert.

Betriebsgerät

Das Produkt ist für den Anschluss an ein Remote-Netzteil (nicht im Lieferumfang enthalten) vorverdrahtet. Dieses ist an einer zugänglichen Stelle anzubringen oder sollte durch die Aussparung passen:

Find Me 0: 50 mm.

Find Me 1: 62 mm.

Find Me 2: 70 mm.

Zubehör

Die Pendelleuchtenversion verfügt, in der Lichtquelle integriert, über einen Abschirmzylinder entweder in Orange, Violett oder Schwarz. Diese können untereinander ausgetauscht werden.

Bei Find Me 1 und 2 ist professionelles Zubehör inklusive.

Zusatzinformationen

Das Schwenksystem ermöglicht auf der Vertikalachse eine Drehung um 360° und auf der Horizontalachse um 70°. Schutzgrad IP20. Schutzklasse III.

Qualitätszeichen

Das Gerät entspricht der europäischen technischen Norm EN60598-1 und den entsprechenden Zusatzregelungen.

Description

Spotlight family for indoor use, easy to mount on plasterboard ceilings, comprised of one or two LED lighting modules.

The luminaire is available in following versions: Mono Point, Double Point and Suspension.

The Mono Point version is supplied with a recessed cylindrical frame, which houses the lighting module. This lighting module can be placed in its upper position, when it will work like a downlight, or in its lower position, becoming an adjustable spotlight.

The Mono Point version is supplied with a frame, which should be fitted to the product if a Trim version is required, or without, if a No Trim version is required.

The Double Point version is supplied with an injected thermoplastic material frame, which houses two lighting modules. Like the Mono Point version, the modules are directional and the frame enables the product to be concealed, leaving just the end visible.

The Suspension version is a variant of the Mono Point version. Its main characteristic is its suspended mounting.

Reflectors

The luminaire is designed for accent lighting.

Power Supply

The fitting is supplied prewired ready to be connected to a remote power supply (not included) installed in an accessible place or to be passed through the ceiling cut-out:

Find Me 0: 50 mm.

Find Me 1: 62 mm.

Find Me 2: 70 mm.

Accessories

The Suspension version has interchangeable screening cylinders in 3 colours: orange, violet or black, incorporated into the light fixture.

For the Find Me 1 and 2: professional accessories included.

Additional Information

Adjustable system that allows a 360° rotation on vertical and 70° on horizontal edge.

IP20 protection grade.

Insulation class III.

Standard Compliance and Quality Marks

EN60598-1 European Technical Standards and any subsequent additions.



Suspension
Surface



Suspension
Recessed



Mono Point
No Trim



Mono Point
Trim

FIND ME

Find Me 0 (Trim / No Trim)

Light Source: Power LED DC 250 mA - 3,5W - 300 lm - 2700K/CRI 90 / 3,5W - 325 lm - 3000K/CRI 90

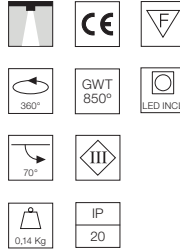
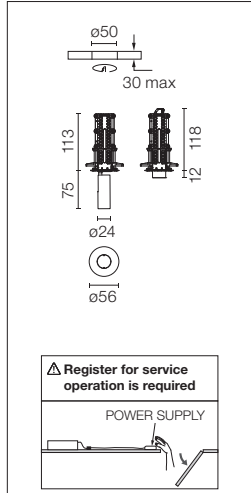

Schwenkbare Einbauleuchte für Innenräume. Fern-Netzteil 250 mA nicht eingeschlossen. Inkludiertes Zubehör (Honeycomb und Blendschutzgitter). Remote-Netzteil zur Anbringung an einer zugänglichen Stelle. installed in an accessible place. Es wird nicht empfohlen, einstellbare Treiber verschiedener Marken zu verwenden, da diese spezielle Regelungskurven haben.

Recessed adjustable luminaire for indoor application. Remote power supply 250 mA not included. Accessories included (honeycomb and screening crosspiece). Remote power supply to be installed in an accessible place. It is not recommended to use dimmable drivers of several brands due to the specific dimming curves of each brand.

Empfohlene Netzgeräte und Anzahl der Leuchten pro Driver (L)* / Recommended power supply and number of luminaires per driver (L)*:

1/2/3L* Non Dimmable 100-240V	60.9744
1/2/3L* Non Dimmable 220-240V	60.9160
1/2/3L* Dimmable Dali 2 110-240V	60.9601
1/2/3L* Dimmable 0-10V 220-240V	60.9405
2/3L* Mains Dimming 220-240V	60.9421
Casambi	60.9392 + 0-10V/Dali driver

Siehe Treiberkapitel / Refer to the Drivers chapter

2700K
 09.3781.30A
 09.3781.06A
 09.3781.14A

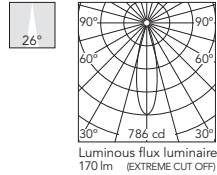

3000K
 09.3780.30A
 09.3780.06A
 09.3780.14A

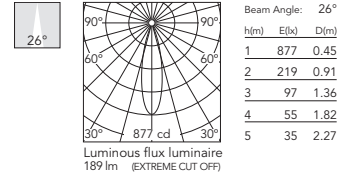

FIND ME

Find Me 1 (Trim / No Trim)

Light Source: Power LED DC 500 mA - 6W - 560 lm - 2700K/CRI 90 / 6W - 600 lm - 3000K/CRI 90

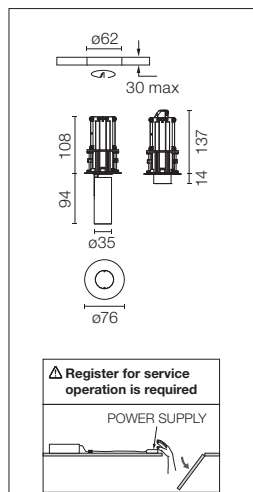

Schwenkbare Einbauleuchte für Innenräume. Fern-Netzteil 500 mA nicht eingeschlossen. Inkludiertes Zubehör (Honeycomb und Blendschutzgitter). Remote-Netzteil zur Anbringung an einer zugänglichen Stelle. installed in an accessible place.

Recessed adjustable luminaire for indoor application. Remote power supply 500 mA not included. Accessories included (honeycomb and screening crosspiece). Remote power supply to be installed in an accessible place.

Empfohlene Netzgeräte / Recommended power supply*:

Non Dimmable 220-240V	60.9160
Non Dimmable 110-240V	60.8880
Dimmable Dali 1 110-240V	60.8847
Dimmable Dali 2 110-240V	60.9222
Mains Dimming 220-240V	60.9411
Dimmable 0/1-10V&Push 110/240V	60.9188
Casambi	60.9207

* Siehe Treiberkapitel / Refer to the Drivers chapter

2700K
09.3751.30A
09.3751.06A
09.3751.14A

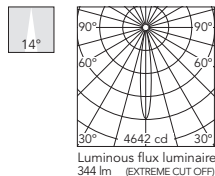

Beam Angle: 14°

h(m)	E(lx)	D(m)
1	4642	0.24
2	1160	0.48
3	516	0.72
4	290	0.95
5	186	1.19

Luminous flux luminaire
344 lm (EXTREME CUT OFF)

3000K
09.3750.30A
09.3750.06A
09.3750.14A

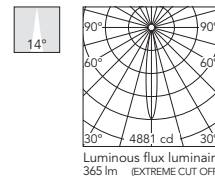

Beam Angle: 14°

h(m)	E(lx)	D(m)
1	4881	0.24
2	1220	0.49
3	542	0.73
4	305	0.97
5	195	1.21

Luminous flux luminaire
365 lm (EXTREME CUT OFF)

2700K
09.3756.30A
09.3756.06A
09.3756.14A

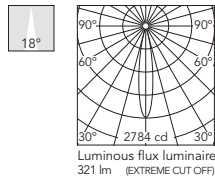

Beam Angle: 18°

h(m)	E(lx)	D(m)
1	2784	0.31
2	696	0.62
3	309	0.93
4	174	1.23
5	111	1.54

Luminous flux luminaire
321 lm (EXTREME CUT OFF)

3000K
09.3755.30A
09.3755.06A
09.3755.14A

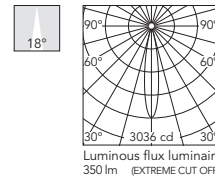

Beam Angle: 18°

h(m)	E(lx)	D(m)
1	3036	0.31
2	759	0.62
3	337	0.93
4	190	1.23
5	121	1.54

Luminous flux luminaire
350 lm (EXTREME CUT OFF)

FIND ME

Find Me 2 (Trim / No Trim)

Light Source: Power LED DC max 850 mA - 10W - 860 lm - 2700K/CRI 90 / 10W - 900 lm - 3000K/CRI 90

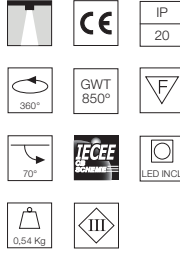
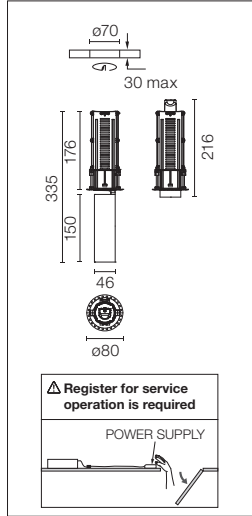

Schwenkbare Einbauleuchte für Innenräume. Fern-Netzteil nicht eingeschlossen. Inkludiertes Zubehör (Honeycomb und Blendschutzgitter). Remote-Netzteil zur Anbringung an einer zugänglichen Stelle. installed in an accessible place.

Recessed adjustable luminaire for indoor application. Remote power supply not included. Accessories included (honeycomb and screening crosspiece). Remote power supply to be installed in an accessible place.

Empfohlene Netzgeräte / Recommended power supply*:

Non Dimmable MC 110-240V	60.8911
Non Dimmable MC 220-240V	60.9162
Non Dimmable 700mA 110-240V	60.8529
Dimmable Dali 1 220-240V	60.9186
Mains Dimming	60.9467
Dim 1-10V/Dim Dali/Push MC 110-240V	60.8530
Casambi	60.9207

* Siehe Treiberkapitel / Refer to the Drivers chapter

2700K
 09.3707.30
 09.3707.06
 09.3707.14

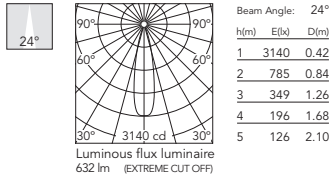

3000K
 09.3708.30A
 09.3708.06A
 09.3708.14A

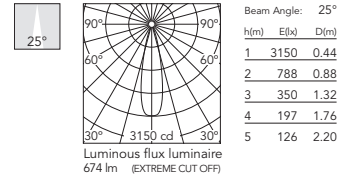

Driver current (mA)	2700K		3000K	
	Luminous flux (lm)	Power (W)	Luminous flux (lm)	Power (W)
850	860	10	900	10
800	820	9	860	9
750	770	9	810	9
700	730	8	770	8

Find Me 1 Suspension

Light Source: Power LED DC 500 mA - 6W - 560 lm - 2700K/CRI 90 / 6W - 600 lm - 3000K/CRI 90

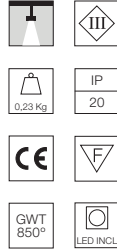
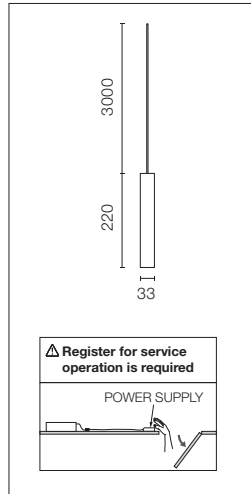

Hängeleuchte für die Deckenmontage. Das Produkt enthält einen austauschbaren Abschirmzylinder in verschiedenen Farben (Orange, Violett und Schwarz). Fern-Netzteil 500 mA nicht eingeschlossen.

Suspended ceiling-mounted luminaire. The product includes interchangeable shield cylinder in different colours (orange, violet and black). Remote power supply 500 mA not included.

Empfohlene Netzgeräte / Recommended power supply*:

Non Dimmable 60.8654
Casambi 60.9207**

* Siehe Treiberkapitel / Refer to the Drivers chapter

** Notwendiger Zugang zum Treiber durch Registrierung / It is necessary to anticipate a space for accessing the driver.

2700K

09.3711.30C
09.3711.06C
09.3711.14C

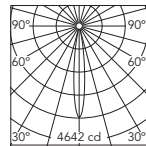

Luminous flux luminaire
344 lm (EXTREME CUT OFF)

Beam Angle: 14°

h(m)	E(lx)	D(m)
1	4642	0.24
2	1160	0.48
3	516	0.72
4	290	0.95
5	186	1.19

3000K

09.3710.30C
09.3710.06C
09.3710.14C

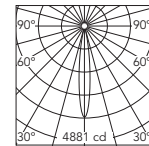

Luminous flux luminaire
365 lm (EXTREME CUT OFF)

Beam Angle: 14°

h(m)	E(lx)	D(m)
1	4881	0.24
2	1220	0.49
3	542	0.73
4	305	0.97
5	195	1.21

Zubehör / Accessories

Einspeisungsbaldachin eingebaut.

Recessed power supply rose.



08.8782.30

Einspeisungsbaldachin aufgebaut.
Nicht dimmbares Netzteil eingeschlossen.

Surface power supply rose.
Non dimmable power supply included.

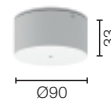

08.8783.30
08.8783.06
08.8783.14

UT SPOT&PRO

DESIGNED BY FLOS ARCHITECTURAL

UT SPOT
CEILING
Ø57



LIGHT SOURCE
LED ARRAY
23,5W
2400 lm
3000K/CRI 80
1950 lm
3000K/CRI 90
2150 lm
4000K/CRI 90

UT SPOT
CEILING
Ø86



LIGHT SOURCE
LED ARRAY
HIGH
PERFORMANCES
33W
3960 lm
3000K/CRI 80
3250 lm
3000K/CRI 90
3500 lm
4000K/CRI 90

LIGHT SOURCE
PHOSPHOR
LED
PERFORMANCES
31W/34W
3000 lm
3000K/CRI 98
29W
3000 lm
4000K/CRI 80

UT SPOT
TRACK
Ø57



LIGHT SOURCE
LED ARRAY
23,5W
2500 lm
3000K/CRI 80
2000 lm
3000K/CRI 90
2150 lm
4000K/CRI 90

UT SPOT
TRACK
Ø86



LIGHT SOURCE
LED ARRAY
HIGH
PERFORMANCES
33W
3960 lm
3000K/CRI 80
3250 lm
3000K/CRI 90
3500 lm
4000K/CRI 90

LIGHT SOURCE
PHOSPHOR
LED
PERFORMANCES
27W
3000 lm
3000K/CRI 98
23W
3000 lm
4000K/CRI 80

UT SPOT
TRACK
WALL-WASHER
Ø86



LIGHT SOURCE
LED ARRAY
HIGH
PERFORMANCES
33W
3960 lm
3000K/CRI 80
3250 lm
3000K/CRI 90
3500 lm
4000K/CRI 90

UT SPOT
TRACK
Ø57



LIGHT SOURCE
LED ARRAY
23,5W
2500 lm
3000K/CRI 80
2000 lm
3000K/CRI 90
2150 lm
4000K/CRI 90

UT SPOT
TRACK
Ø86



LIGHT SOURCE
LED ARRAY
HIGH
PERFORMANCES
33W
3770 lm
3000K/CRI 80
3116 lm
3000K/CRI 90
3246 lm
4000K/CRI 90

LIGHT SOURCE
PHOSPHOR
LED
PERFORMANCES
31W/34W
2650 lm
3000K/CRI 98
29W
3000 lm
4000K/CRI 80

UT SPOT
TRACK
MULTICHIP
Ø86



LIGHT SOURCE
TOP LED
11,5W
850 lm
3000K/CRI 90
950 lm
3000K/CRI 80
1000 lm
4000K/CRI 80

UT SPOT
TRACK
WALL-WASHER
Ø86



LIGHT SOURCE
LED ARRAY
HIGH
PERFORMANCES
33W
3960 lm
3000K/CRI 80
3250 lm
3000K/CRI 90
3500 lm
4000K/CRI 90

UT SPOT&PRO

UT PRO
150 GA-69



LIGHT SOURCE
LED ARRAY
23,5W
2300 lm
3000K/CRI 80
1950 lm
3000K/CRI 90
2009 lm
4000K/CRI 90

UT PRO
175 GA-69



LIGHT SOURCE
LED ARRAY
35,3W
4145 lm
3000K/CRI 80
3425 lm
3000K/CRI 90
3569 lm
4000K/CRI 90

UT PRO
175 LENS
GA-69



LIGHT SOURCE
LED ARRAY
35,3W
3950 lm
3000K/CRI 80
3250 lm
3000K/CRI 90
3400 lm
4000K/CRI 90

UT PRO
WALL-WASHER
GA-69



LIGHT SOURCE
TOP LED
25,5W
2700 lm
3000K/CRI 90
2900 lm
4000K/CRI 90

□ 30 Weiss
30 White

■ 14 Schwarz
14 Black



□ 30 Weiss
30 White

■ 14 Schwarz
14 Black

□ 30.78 All White
30.78 All White



Produktbeschreibung

Innenraumleuchte für die Installation auf 3-Phasenstromschiene oder an Decken. Erhältlich für Lichtquellen mit hocheffizienter LED-Technologie sowie in DALI- und Nicht-DALI-Version.

Die Modellreihe ist in zwei Größen (Ø57 und Ø86) und vier verschiedenen Versionen erhältlich: Track (absolute Flexibilität bei der Installation), Ceiling (Einzelinstallation), Multichip (Strahlungswinkel kleiner als 150°) und Wall-Washer (nur in der Größe Ø86).

Der optische Leuchtenkörper ist aus Aluminium Hochdruckguss mit Pulverbeschichtung in Weiß oder Schwarz gefertigt.

Fernnetzgerät in der Deckenversion inbegriffen. Auch als UT Downlight erhältlich (siehe Abschnitt Downlights im Katalog).

Betriebsgerät

Netzteil für konstante Stromzufuhr mit oder ohne DALI-Steuerung 220-240V eingeschlossen.

Mit Potentiometer in der Track Version mit Box.

Die Versionen mit integriertem Adapter haben kein Potentiometer.

Zubehör

- Querabschirmung, elliptische linse, fluterlinse und honeycomb verfügbar.
- Haltering (UT Spot ø86).

Zusatzinformationen

Auf normal entflammbaren Oberflächen einsetzbar.

Die FLOS Schienenleuchten wurden für 3-Phasen Standardschienen, die von FLOS empfohlen werden, entwickelt und umfassend getestet. Ihre Kompatibilität ist mit denen von Nordic Aluminium produzierten 3-Phasen-Schienen garantiert. Kompatibilität mit Eutrac auf Anfrage. Wenn Sie die Kompatibilität mit anderen Schienen überprüfen möchten, kontaktieren Sie bitte FLOS vor der Installation.

Die FLOS 3-phasen DALI-Schienenleuchten sind für Pulse DALI Protokoll von Nordic Aluminium entwickelt.

- UT Spot ø86 (Track / Ceiling):

Die LED-Module mit Phosphor-LED erreichen dank der Remote-Phosphor-Technologie je nach Modell einen Farbwiedergabeindex von bis zu 98 und bieten die bestmögliche Lichtqualität und Wahrnehmung von Gegenständen und Raum.

Die LED-Module der Modellreihe LED Array entsprechen dem neuesten Stand der Technik, der sich durch eine geringere Durchschnittstemperatur im elektronischen Betrieb auszeichnet. Dank dieser Eigenschaft kann die Lichtquelle, innerhalb der Sicherheitsparameter, mit einer höheren Leistung betrieben werden und einen 20 % größeren Lichtstrom erzeugen.

Qualitätszeichen

Das Gerät entspricht der europäischen technischen Norm EN60598-1 und den entsprechenden Zusatzregelungen.

Description

A luminaire for indoor use to be mounted on three phase track or on ceilings, available in LED technology light sources and in DALI and non-DALI versions.

The family is available in two sizes (Ø57 / Ø86) and in four different versions: Track (totally flexible installation), Ceiling (stand-alone installation), Multichip (beam angles less than 150°) and Wall-Washer (only Ø86 version).

The optical housing of the luminaire is manufactured in high-pressure injected aluminium, with white or black finishes.

Remote driver included in ceiling versions.

Also available UT Downlight (see Downlights catalogue section).

Power Supply

Not dimmable or dimmable Dali 220-240V, constant current, power supply included.

Includes a built-in potentiometer in the track with box version. Versions with a built-in adapter do not include a potentiometer.

Accessories

- Screening crosspiece, elliptical lens, flood lens and honeycomb.
- Support ring (UT Spot ø86).

Additional Information

Suitable for installation on normally inflammable surfaces. FLOS three-phase lighting track luminaires are designed and fully tested for tracks recommended by FLOS.

Compatibility is guaranteed with three-phase track produced by Nordic Aluminium. Compatibility with Eutrac under request. To verify compatibility with any other track, please contact FLOS before installation.

FLOS three-phase DALI track luminaires are designed for Pulse DALI from Nordic Aluminium.

- UT Spot ø86 (Track / Ceiling):

Thanks to remote-phosphor technology, the LED modules of the Phosphor LED versions offer maximum quality light, the perception of objects and spaces, reaching chromatic reproduction indices of 98, depending on the version.

The LED modules installed on the LED Array versions have cutting-edge technology that permit a lower average temperature in the electronics. Thanks to this feature, the luminaire can operate at a higher power inside the safety parameters, yet still offer 20% added luminous flux.

Standard Compliance and Quality Marks

EN60598-1 European Technical Standards and any subsequent additions.



UT Spot Ceiling



UT Spot Track

UT SPOT

Ut Spot Ceiling Ø57

Light Source: LED Array 23,5W - 2400 lm - 3000K/CRI 80 / 23,5W - 1950 lm - 3000K/CRI 90 / 23,5W - 2150 lm - 4000K/CRI 90

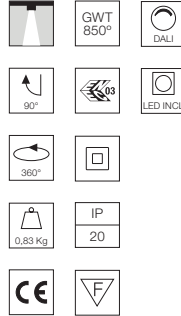
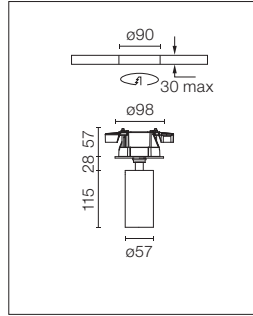

Deckenstrahler mit LED-Lampe. Fernnetzgerät mit 220-240V, 50-60Hz inbegriffen.

Spotlight to be installed on ceiling with LED light source. 220-240V, 50-60Hz remote power supply included.

3000K - CRI 80

- Non Dimmable
 09.4460.30A
 09.4460.14A
 Dali Version
 09.4460.30ADA
 09.4460.14ADA

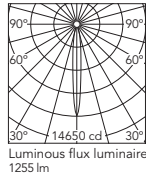

Beam Angle: 10°

h(m)	E(lx)	D(m)
1	14650	0.18
2	3662	0.36
3	1628	0.54
4	916	0.72
5	586	0.90

4000K - CRI 90

- Non Dimmable
 09.4470.30A
 09.4470.14A
 Dali Version
 09.4470.30ADA
 09.4470.14ADA

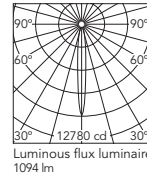

Beam Angle: 10°

h(m)	E(lx)	D(m)
1	12780	0.18
2	3195	0.36
3	1420	0.54
4	799	0.72
5	511	0.90

3000K - CRI 90

- Non Dimmable
 09.4463.30A
 09.4463.14A
 Dali Version
 09.4463.30ADA
 09.4463.14ADA

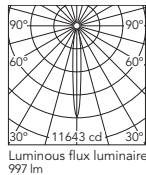

Beam Angle: 10°

h(m)	E(lx)	D(m)
1	11643	0.18
2	2911	0.36
3	1294	0.54
4	728	0.72
5	466	0.90

3000K - CRI 80

- Non Dimmable
 09.4461.30A
 09.4461.14A
 Dali Version
 09.4461.30ADA
 09.4461.14ADA

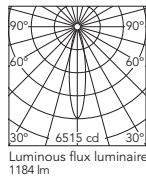

Beam Angle: 21°

h(m)	E(lx)	D(m)
1	6515	0.37
2	1629	0.73
3	724	1.10
4	407	1.47
5	261	1.83

4000K - CRI 90

- Non Dimmable
 09.4471.30A
 09.4471.14A
 Dali Version
 09.4471.30ADA
 09.4471.14ADA

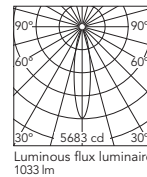

Beam Angle: 21°

h(m)	E(lx)	D(m)
1	5683	0.37
2	1421	0.73
3	631	1.10
4	355	1.47
5	227	1.83

3000K - CRI 90

- Non Dimmable
 09.4464.30A
 09.4464.14A
 Dali Version
 09.4464.30ADA
 09.4464.14ADA

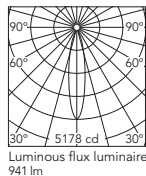

Beam Angle: 21°

h(m)	E(lx)	D(m)
1	5178	0.37
2	1294	0.73
3	575	1.10
4	324	1.47
5	207	1.83

3000K - CRI 80

- Non Dimmable
 09.4462.30A
 09.4462.14A
 Dali Version
 09.4462.30ADA
 09.4462.14ADA

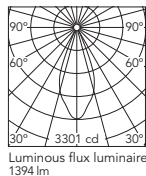

Beam Angle: 42°

h(m)	E(lx)	D(m)
1	3301	0.76
2	825	1.52
3	367	2.28
4	206	3.05
5	132	3.81

4000K - CRI 90

- Non Dimmable
 09.4472.30A
 09.4472.14A
 Dali Version
 09.4472.30ADA
 09.4472.14ADA

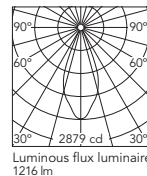

Beam Angle: 42°

h(m)	E(lx)	D(m)
1	2879	0.76
2	720	1.52
3	320	2.28
4	180	3.05
5	115	3.81

3000K - CRI 90

- Non Dimmable
 09.4465.30A
 09.4465.14A
 Dali Version
 09.4465.30ADA
 09.4465.14ADA

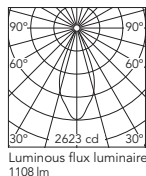

Beam Angle: 42°

h(m)	E(lx)	D(m)
1	2623	0.76
2	656	1.52
3	291	2.28
4	164	3.05
5	105	3.81

UT SPOT

Ut Spot Ceiling Ø86

Light Source: LED Array High Performances 33W - 3960 lm - 3000K/CRI 80 / 33W - 3250 lm - 3000K/CRI 90 / 33W - 3500 lm - 4000K/CRI 90

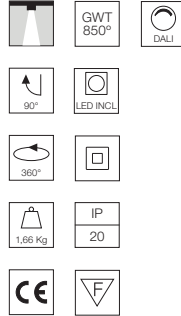
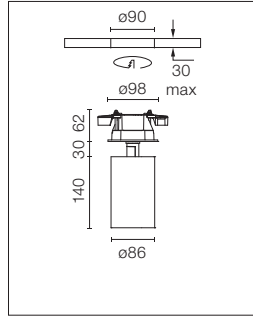

Deckenstrahler mit LED-Lampe.
Fernnetzgerät mit 220-240V, 50-60Hz inbegriffen.

Spotlight to be installed on ceiling
with LED light source. 220-240V, 50-60Hz remote power supply included.

3000K - CRI 80

- Non Dimmable
 09.4860.30A
 09.4860.14A
 Dali Version
 09.4860.30ADA
 09.4860.14ADA

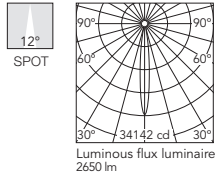

Beam Angle: 12°

h(m)	E(lx)	D(m)
1	34142	0.21
2	8535	0.41
3	3794	0.62
4	2134	0.82
5	1366	1.03

4000K - CRI 90

- Non Dimmable
 09.4870.30A
 09.4870.14A
 Dali Version
 09.4870.30ADA
 09.4870.14ADA

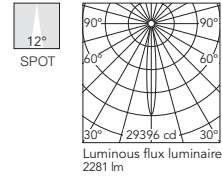

Beam Angle: 12°

h(m)	E(lx)	D(m)
1	29376	0.21
2	7349	0.41
3	3266	0.62
4	1837	0.82
5	1176	1.03

3000K - CRI 90

- Non Dimmable
 09.4863.30A
 09.4863.14A
 Dali Version
 09.4863.30ADA
 09.4863.14ADA

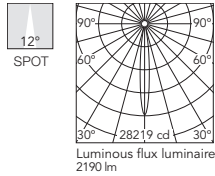

Beam Angle: 12°

h(m)	E(lx)	D(m)
1	28219	0.21
2	7055	0.41
3	3135	0.62
4	1764	0.82
5	1129	1.03

3000K - CRI 80

- Non Dimmable
 09.4861.30A
 09.4861.14A
 Dali Version
 09.4861.30ADA
 09.4861.14ADA

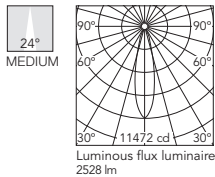

Beam Angle: 24°

h(m)	E(lx)	D(m)
1	11472	0.43
2	2868	0.86
3	1275	1.28
4	717	1.71
5	459	2.14

4000K - CRI 90

- Non Dimmable
 09.4871.30A
 09.4871.14A
 Dali Version
 09.4871.30ADA
 09.4871.14ADA

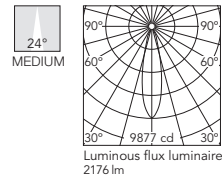

Beam Angle: 24°

h(m)	E(lx)	D(m)
1	9877	0.43
2	2469	0.86
3	1097	1.28
4	617	1.71
5	395	2.14

3000K - CRI 90

- Non Dimmable
 09.4864.30A
 09.4864.14A
 Dali Version
 09.4864.30ADA
 09.4864.14ADA

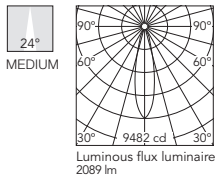

Beam Angle: 24°

h(m)	E(lx)	D(m)
1	9482	0.43
2	2370	0.86
3	1054	1.28
4	593	1.71
5	379	2.14

3000K - CRI 80

- Non Dimmable
 09.4862.30A
 09.4862.14A
 Dali Version
 09.4862.30ADA
 09.4862.14ADA

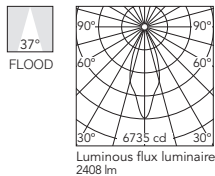

Beam Angle: 37°

h(m)	E(lx)	D(m)
1	6735	0.67
2	1684	1.34
3	748	2.01
4	421	2.69
5	269	3.36

4000K - CRI 90

- Non Dimmable
 09.4872.30A
 09.4872.14A
 Dali Version
 09.4872.30ADA
 09.4872.14ADA

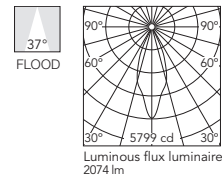

Beam Angle: 37°

h(m)	E(lx)	D(m)
1	5799	0.67
2	1450	1.34
3	644	2.01
4	362	2.69
5	232	3.36

3000K - CRI 90

- Non Dimmable
 09.4865.30A
 09.4865.14A
 Dali Version
 09.4865.30ADA
 09.4865.14ADA

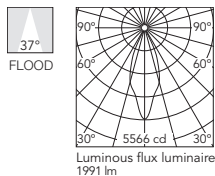

Beam Angle: 37°

h(m)	E(lx)	D(m)
1	5566	0.67
2	1392	1.34
3	618	2.01
4	348	2.69
5	223	3.36

UT SPOT

Ut Spot Ceiling Ø86

Light Source: Phosphor LED 31W/34W - 3000 lm - 3000K/CRI 98 / 29W - 3000 lm - 4000K/CRI 80

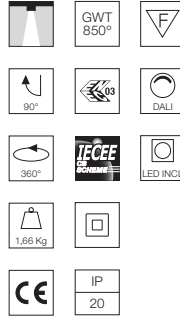
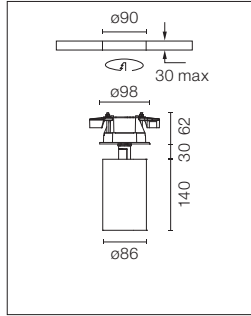

Deckenstrahler mit LED-Lampe. Fernnetzgerät mit 220-240V, 50-60Hz inbegriffen.

Spotlight to be installed on ceiling with LED light source. 220-240V, 50-60Hz remote power supply included.

ENEC 03 gilt nicht für Referenzen: 09.4264.XX.XX 09.4271.XX.XX

ENEC 03 not applicable to references: 09.4264.XX.XX 09.4271.XX.XX

3000K - CRI 98

Non Dimmable

- 09.4263.30
- 09.4263.14
- Dali Version
- 09.4263.30.DA
- 09.4263.14.DA

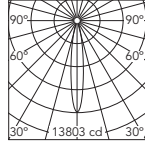

Beam Angle: 16°

h(m)	E(lx)	D(m)
1	13803	0.28
2	3451	0.55
3	1534	0.83
4	863	1.10
5	552	1.38

Luminous flux luminaire 1822 lm

4000K - CRI 80

Non Dimmable

- 09.4270.30
- 09.4270.14
- Dali Version
- 09.4270.30.DA
- 09.4270.14.DA

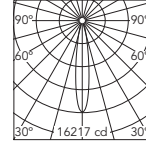

Beam Angle: 17°

h(m)	E(lx)	D(m)
1	16217	0.29
2	4054	0.58
3	1802	0.88
4	1014	1.17
5	649	1.46

Luminous flux luminaire 2216 lm

3000K - CRI 98

Non Dimmable

- 09.4264.30A
- 09.4264.14A
- Dali Version
- 09.4264.30ADA
- 09.4264.14ADA

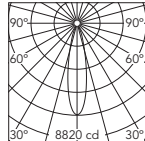

Beam Angle: 23°

h(m)	E(lx)	D(m)
1	8820	0.41
2	2205	0.82
3	980	1.23
4	551	1.64
5	353	2.05

Luminous flux luminaire 1898 lm

4000K - CRI 80

Non Dimmable

- 09.4271.30A
- 09.4271.14A
- Dali Version
- 09.4271.30ADA
- 09.4271.14ADA

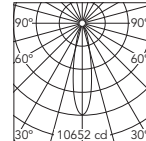

Beam Angle: 23°

h(m)	E(lx)	D(m)
1	10652	0.41
2	2663	0.81
3	1184	1.22
4	666	1.63
5	426	2.03

Luminous flux luminaire 2260 lm

3000K - CRI 98

Non Dimmable

- 09.4265.30
- 09.4265.14
- Dali Version
- 09.4265.30.DA
- 09.4265.14.DA

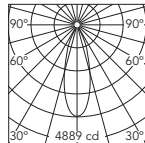

Beam Angle: 32°

h(m)	E(lx)	D(m)
1	4889	0.57
2	1222	1.15
3	543	1.72
4	306	2.29
5	196	2.87

Luminous flux luminaire 1654 lm

4000K - CRI 80

Non Dimmable

- 09.4272.30
- 09.4272.14
- Dali Version
- 09.4272.30.DA
- 09.4272.14.DA

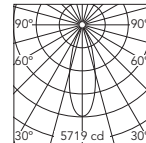

Beam Angle: 32°

h(m)	E(lx)	D(m)
1	5719	0.58
2	1430	1.15
3	635	1.73
4	357	2.31
5	229	2.89

Luminous flux luminaire 1947 lm

UT SPOT

Ut Spot Track Ø57

Light Source: LED Array 23,5W - 2500 lm - 3000K/CRI 80 / 23,5W - 2000 lm - 3000K/CRI 90 / 23,5W- 2150 lm - 4000K/CRI 90

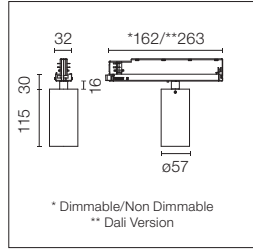

Strahler für 3-Phasen-Stromschiene mit LED-Lampe. Netzgerät mit 220-240V, 50-60Hz inbegriffen.

Spotlight to be installed on 3-phase track with LED light source. 220-240V, 50-60Hz power supply integrated.

Bei den Versionen 30 sind der Schienenadapter, der Arm und der Hinterkopf schwarz. Bei den "All White" -Versionen sind der Schienenadapter, der Arm, der Hinterkopf und der Kopf weiß, nur der Blendschutzring bleibt schwarz.

.30 versions come with the track adapter, the arm and the rear of the head in black. In the "All white" versions, the track adapter, the arm, the rear of the head and the head are white. Only the anti-glare ring is black.

3000K - CRI 80

- Non Dimmable
- 09.7700.30A
- 09.7700.14A
- Non Dimmable All White
- 09.7700.30A78
- Dali Version
- 09.7700.30ADA
- 09.7700.14ADA
- Dali Version All White
- 09.7700.30AYU

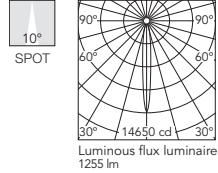

4000K - CRI 90

- Non Dimmable
- 09.7701.30A
- 09.7701.14A
- Non Dimmable All White
- 09.7701.30A78
- Dali Version
- 09.7701.30ADA
- 09.7701.14ADA
- Dali Version All White
- 09.7701.30AYU

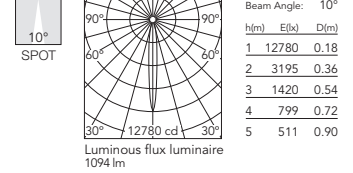

3000K - CRI 80

- Non Dimmable
- 09.7702.30A
- 09.7702.14A
- Non Dimmable All White
- 09.7702.30A78
- Dali Version
- 09.7702.30ADA
- 09.7702.14ADA
- Dali Version All White
- 09.7702.30AYU

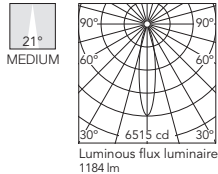

4000K - CRI 90

- Non Dimmable
- 09.7703.30A
- 09.7703.14A
- Non Dimmable All White
- 09.7703.30A78
- Dali Version
- 09.7703.30ADA
- 09.7703.14ADA
- Dali Version All White
- 09.7703.30AYU

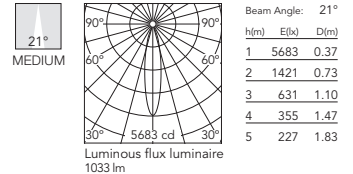

3000K - CRI 80

- Non Dimmable
- 09.7704.30A
- 09.7704.14A
- Non Dimmable All White
- 09.7704.30A78
- Dali Version
- 09.7704.30ADA
- 09.7704.14ADA
- Dali Version All White
- 09.7704.30AYU

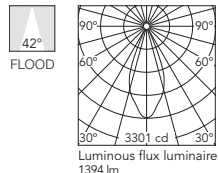

4000K - CRI 90

- Non Dimmable
- 09.7705.30A
- 09.7705.14A
- Non Dimmable All White
- 09.7705.30A78
- Dali Version
- 09.7705.30ADA
- 09.7705.14ADA
- Dali Version All White
- 09.7705.30AYU

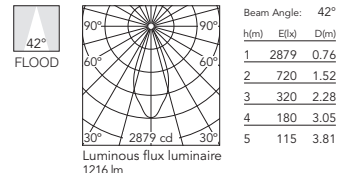

3000K - CRI 90

- Non Dimmable
- 09.7708.30A
- 09.7708.14A
- Non Dimmable All White
- 09.7708.30A78
- Dali Version
- 09.7708.30ADA
- 09.7708.14ADA
- Dali Version All White
- 09.7708.30AYU

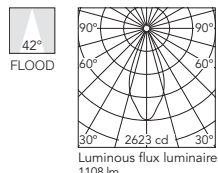

UT SPOT

Ut Spot Track Ø86

Light Source: LED Array High Performances 33W - 3770 lm - 3000K/CRI 80 / 33W - 3116 lm - 3000K/CRI 90 / 33W - 3246 lm - 4000K/CRI 90

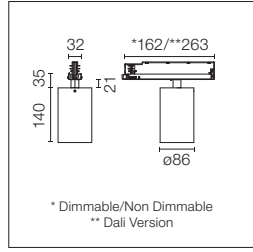

Strahler für 3-Phasen-Stromschiene mit LED-Lampe. Netzgerät mit 220-240V, 50-60Hz inbegriffen.

Spotlight to be installed on 3-phase track with LED light source. 220-240V, 50-60Hz power supply integrated.

Bei den Versionen 30 sind der Schienenadapter, der Arm und der Hinterkopf schwarz. Bei den "All White"-Versionen sind der Schienenadapter, der Arm, der Hinterkopf und der Kopf weiß, nur der Blendschutzring bleibt schwarz.

.30 versions come with the track adapter, the arm and the rear of the head in black. In the "All white" versions, the track adapter, the arm, the rear of the head and the head are white. Only the anti-glare ring is black.

3000K - CRI 80

- Non Dimmable
- 09.7750.30A
- 09.7750.14A
- Non Dimmable All White
- 09.7750.30A78
- Dali Version
- 09.7750.30ADA
- 09.7750.14ADA
- Dali Version All White
- 09.7750.30AYU

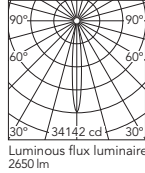

Beam Angle: 12°	h(m)	E(lx)	D(m)
1	34142	0.21	
2	8535	0.41	
3	3794	0.62	
4	2134	0.82	
5	1366	1.03	

4000K - CRI 90

- Non Dimmable
- 09.7751.30A
- 09.7751.14A
- Non Dimmable All White
- 09.7751.30A78
- Dali Version
- 09.7751.30ADA
- 09.7751.14ADA
- Dali Version All White
- 09.7751.30AYU

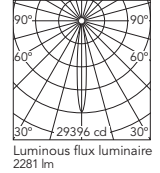

Beam Angle: 12°	h(m)	E(lx)	D(m)
1	29396	0.21	
2	7349	0.41	
3	3266	0.62	
4	1837	0.82	
5	1176	1.03	

3000K - CRI 80

- Non Dimmable
- 09.7752.30A
- 09.7752.14A
- Non Dimmable All White
- 09.7752.30A78
- Dali Version
- 09.7752.30ADA
- 09.7752.14ADA
- Dali Version All White
- 09.7752.30AYU

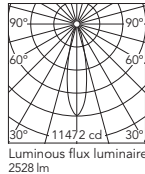

Beam Angle: 24°	h(m)	E(lx)	D(m)
1	11472	0.43	
2	2868	0.86	
3	1275	1.28	
4	717	1.71	
5	459	2.14	

4000K - CRI 90

- Non Dimmable
- 09.7753.30A
- 09.7753.14A
- Non Dimmable All White
- 09.7753.30A78
- Dali Version
- 09.7753.30ADA
- 09.7753.14ADA
- Dali Version All White
- 09.7753.30AYU

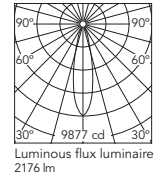

Beam Angle: 24°	h(m)	E(lx)	D(m)
1	9877	0.43	
2	2469	0.86	
3	1097	1.28	
4	617	1.71	
5	395	2.14	

3000K - CRI 80

- Non Dimmable
- 09.7754.30A
- 09.7754.14A
- Non Dimmable All White
- 09.7754.30A78
- Dali Version
- 09.7754.30ADA
- 09.7754.14ADA
- Dali Version All White
- 09.7754.30AYU

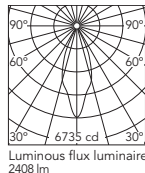

Beam Angle: 37°	h(m)	E(lx)	D(m)
1	6735	0.67	
2	1684	1.34	
3	748	2.01	
4	421	2.69	
5	269	3.36	

4000K - CRI 90

- Non Dimmable
- 09.7755.30A
- 09.7755.14A
- Non Dimmable All White
- 09.7755.30A78
- Dali Version
- 09.7755.30ADA
- 09.7755.14ADA
- Dali Version All White
- 09.7755.30AYU

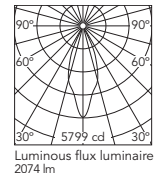

Beam Angle: 37°	h(m)	E(lx)	D(m)
1	5799	0.67	
2	1450	1.34	
3	644	2.01	
4	362	2.69	
5	232	3.36	

3000K - CRI 90

- Non Dimmable
- 09.7758.30A
- 09.7758.14A
- Non Dimmable All White
- 09.7758.30A78
- Dali Version
- 09.7758.30ADA
- 09.7758.14ADA
- Dali Version All White
- 09.7758.30AYU

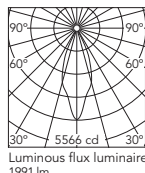

Beam Angle: 37°	h(m)	E(lx)	D(m)
1	5566	0.67	
2	1392	1.34	
3	618	2.01	
4	348	2.69	
5	223	3.36	

UT SPOT

Ut Spot Track Ø86

Light Source: Phosphor LED 27W - 3000 lm - 3000K/CRI 98 / 23W - 3000 lm - 4000K/CRI 80

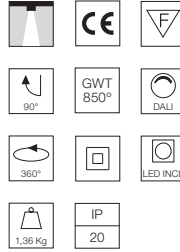
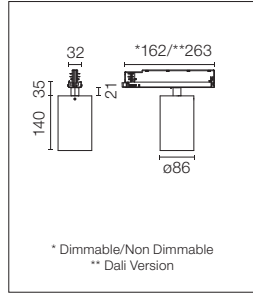

Strahler für 3-Phasen-Stromschiene mit LED-Lampe. Netzgerät mit 220-240V, 50-60Hz inbegriffen.

Spotlight to be installed on 3-phase track with LED light source. 220-240V, 50-60Hz power supply integrated.

Bei den Versionen 30 sind der Schienenadapter, der Arm und der Hinterkopf schwarz. Bei den "All White" -Versionen sind der Schienenadapter, der Arm, der Hinterkopf und der Kopf weiß, nur der Blendschutzring bleibt schwarz.

.30 versions come with the track adapter, the arm and the rear of the head in black. In the "All white" versions, the track adapter, the arm, the rear of the head and the head are white. Only the anti-glare ring is black.

Finishes Available



3000K - CRI 98

- Non Dimmable
- 09.7733.30
 - 09.7733.14
 - 09.7733.30.78

- Dali Version
- 09.7733.30.DA
 - 09.7733.14.DA
 - 09.7733.30.YU

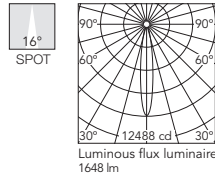

4000K - CRI 80

- Non Dimmable
- 09.7730.30
 - 09.7730.14
 - 09.7730.30.78

- Dali Version
- 09.7730.30.DA
 - 09.7730.14.DA
 - 09.7730.30.YU

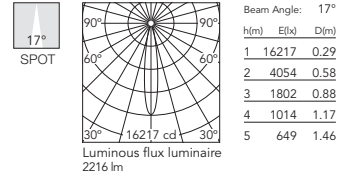

3000K - CRI 98

- Non Dimmable
- 09.7734.30A
 - 09.7734.14A
 - 09.7734.30A78

- Dali Version
- 09.7734.30ADA
 - 09.7734.14ADA
 - 09.7734.30AYU

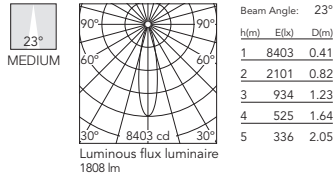

4000K - CRI 80

- Non Dimmable
- 09.7731.30A
 - 09.7731.14A
 - 09.7731.30A78

- Dali Version
- 09.7731.30ADA
 - 09.7731.14ADA
 - 09.7731.30AYU

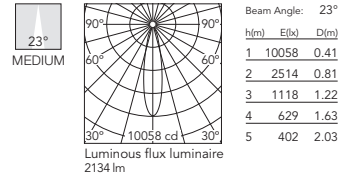

3000K - CRI 98

- Non Dimmable
- 09.7735.30
 - 09.7735.14
 - 09.7735.30.78

- Dali Version
- 09.7735.30.DA
 - 09.7735.14.DA
 - 09.7735.30.YU

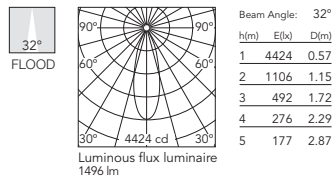

4000K - CRI 80

- Non Dimmable
- 09.7732.30
 - 09.7732.14
 - 09.7732.30.78

- Dali Version
- 09.7732.30.DA
 - 09.7732.14.DA
 - 09.7732.30.YU

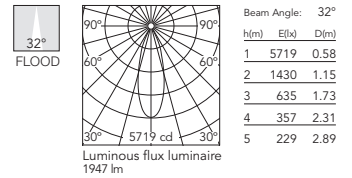

UT SPOT

Ut Spot Track Wall-Washer Ø86

Light Source: LED Array High Performances 33W - 3960 lm - 3000K/CRI 80 / 33W - 3250 lm - 3000K/CRI 90 / 33W - 3500 lm - 4000K/CRI 90

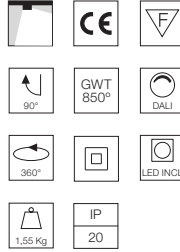
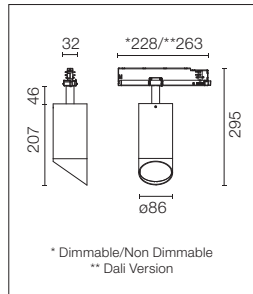

Strahler für 3-Phasen-Stromschiene mit LED-Lampe. Netzgerät mit 220-240V, 50-60Hz inbegriffen.

Spotlight to be installed on 3-phase track with LED light source. 220-240V, 50-60Hz power supply integrated.

Bei den Versionen 30 sind der Schienenadapter, der Arm und der Hinterkopf schwarz. Bei den "All White" -Versionen sind der Schienenadapter, der Arm, der Hinterkopf und der Kopf weiß, nur der Blendschutzring bleibt schwarz.

.30 versions come with the track adapter, the arm and the rear of the head in black. In the "All white" versions, the track adapter, the arm, the rear of the head and the head are white. Only the anti-glare ring is black.

Finishes Available



3000K - CRI 80

Non Dimmable

- 09.7770.30A
- 09.7770.14A
- All White
- 09.7770.30A78

Dali Version

- 09.7770.30ADA
- 09.7770.14ADA
- Dali Version All White
- 09.7770.30AYU

3000K - CRI 90

Non Dimmable

- 09.7771.30A
- 09.7771.14A
- All White
- 09.7771.30A78

Dali Version

- 09.7771.30ADA
- 09.7771.14ADA
- Dali Version All White
- 09.7771.30AYU

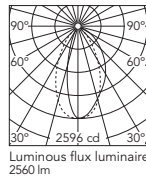

Beam Angle: 50°

h(m)	E(lx)	D(m)
1	2596	0.98
2	649	1.97
3	288	2.95
4	162	3.94
5	104	4.92

Luminous flux luminaire 2560 lm

4000K - CRI 90

Non Dimmable

- 09.7772.30A
- 09.7772.14A
- All White
- 09.7772.30A78

Dali Version

- 09.7772.30ADA
- 09.7772.14ADA
- Dali Version All White
- 09.7772.30AYU

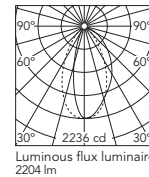

Beam Angle: 50°

h(m)	E(lx)	D(m)
1	2236	0.98
2	559	1.97
3	248	2.95
4	140	3.94
5	89	4.92

Luminous flux luminaire 2204 lm

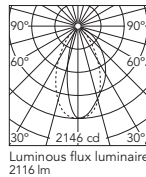

Beam Angle: 50°

h(m)	E(lx)	D(m)
1	2146	0.98
2	537	1.97
3	238	2.95
4	134	3.94
5	86	4.92

Luminous flux luminaire 2116 lm

UT SPOT

Ut Spot Track Ø57

Light Source: LED Array 23,5W - 2500 lm - 3000K/CRI 80 / 23,5W - 2000 lm - 3000K/CRI 90 / 23,5W - 2150 lm - 4000K/CRI 90

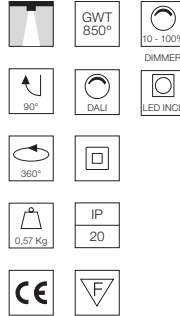
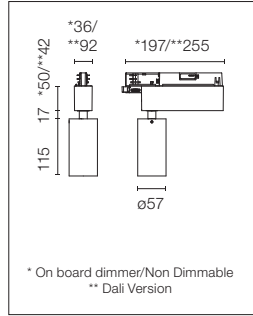

Strahler für 3-Phasen-Stromschiene mit LED-Lampe. Netzgerät mit 220-240V, 50-60Hz inbegriffen.

Spotlight to be installed on 3-phase track with LED light source. 220-240V, 50-60Hz power supply integrated.

3000K - CRI 80

- On board dimmer
- ☐ 09.4440.30A
 - 09.4440.14A
- Non Dimmable
- ☐ 09.4480.30A
 - 09.4480.14A
- Dali Version

- ☐ 09.4440.30ADA
- 09.4440.14ADA

3000K - CRI 90

- On board dimmer
- ☐ 09.4443.30A
 - 09.4443.14A
- Non Dimmable
- ☐ 09.4486.30A
 - 09.4486.14A
- Dali Version

- ☐ 09.4443.30ADA
- 09.4443.14ADA

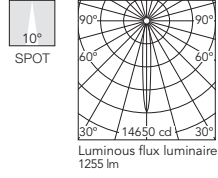

Luminous flux luminaire 1255 lm

4000K - CRI 90

- On board dimmer included
- ☐ 09.4450.30A
 - 09.4450.14A
- Non Dimmable
- ☐ 09.4481.30A
 - 09.4481.14A
- Dali Version

- ☐ 09.4450.30ADA
- 09.4450.14ADA

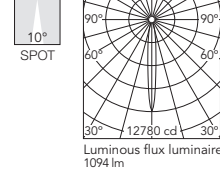

Luminous flux luminaire 1094 lm

3000K - CRI 80

- On board dimmer
- ☐ 09.4441.30A
 - 09.4441.14A
- Non Dimmable
- ☐ 09.4482.30A
 - 09.4482.14A
- Dali Version

- ☐ 09.4441.30ADA
- 09.4441.14ADA

3000K - CRI 90

- On board dimmer
- ☐ 09.4444.30A
 - 09.4444.14A
- Non Dimmable
- ☐ 09.4487.30A
 - 09.4487.14A
- Dali Version

- ☐ 09.4444.30ADA
- 09.4444.14ADA

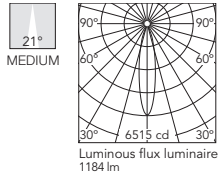

Luminous flux luminaire 1184 lm

4000K - CRI 90

- On board dimmer included
- ☐ 09.4451.30A
 - 09.4451.14A
- Non Dimmable
- ☐ 09.4483.30A
 - 09.4483.14A
- Dali Version

- ☐ 09.4451.30ADA
- 09.4451.14ADA

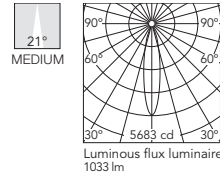

Luminous flux luminaire 1033 lm

3000K - CRI 80

- On board dimmer
- ☐ 09.4442.30A
 - 09.4442.14A
- Non Dimmable
- ☐ 09.4484.30A
 - 09.4484.14A
- Dali Version

- ☐ 09.4442.30ADA
- 09.4442.14ADA

3000K - CRI 90

- On board dimmer
- ☐ 09.4445.30A
 - 09.4445.14A
- Non Dimmable
- ☐ 09.4488.30A
 - 09.4488.14A
- Dali Version

- ☐ 09.4445.30ADA
- 09.4445.14ADA

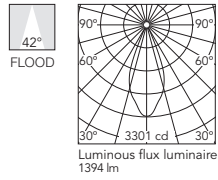

Luminous flux luminaire 1394 lm

4000K - CRI 90

- On board dimmer included
- ☐ 09.4452.30A
 - 09.4452.14A
- Non Dimmable
- ☐ 09.4485.30A
 - 09.4485.14A
- Dali Version

- ☐ 09.4452.30ADA
- 09.4452.14ADA

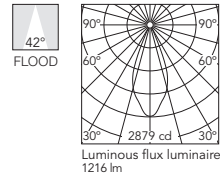

Luminous flux luminaire 1216 lm

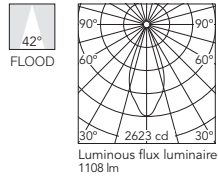

Luminous flux luminaire 1108 lm

UT SPOT

Ut Spot Track Ø86

Light Source: LED Array High Performances 33W - 3770 lm - 3000K/CRI 80 / 33W - 3116 lm - 3000K/CRI 90 / 33W - 3246 lm - 4000K/CRI 90

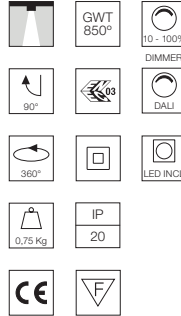
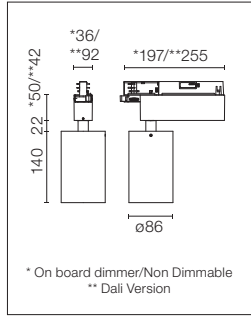

Strahler für 3-Phasen-Stromschiene mit LED-Lampe. Netzgerät mit 220-240V, 50-60Hz inbegriffen.

Spotlight to be installed on 3-phase track with LED light source. 220-240V, 50-60Hz power supply integrated.

3000K - CRI 80

- On board dimmer
- 09.4840.30A
- 09.4840.14A
- Non Dimmable
- 09.4880.30A
- 09.4880.14A
- Dali Version
- 09.4840.30ADA
- 09.4840.14ADA

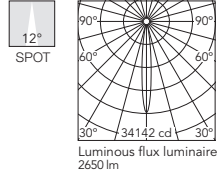

Beam Angle: 12°

h(m)	E(lx)	D(m)
1	34142	0.21
2	8535	0.41
3	3794	0.62
4	2134	0.82
5	1366	1.03

4000K - CRI 90

- On board dimmer included
- 09.4850.30A
- 09.4850.14A
- Non Dimmable
- 09.4881.30A
- 09.4881.14A
- Dali Version
- 09.4850.30ADA
- 09.4850.14ADA

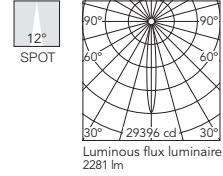

Beam Angle: 12°

h(m)	E(lx)	D(m)
1	29396	0.21
2	7349	0.41
3	3266	0.62
4	1837	0.82
5	1176	1.03

3000K - CRI 90

- On board dimmer
- 09.4843.30A
- 09.4843.14A
- Non Dimmable
- 09.4886.30A
- 09.4886.14A
- Dali Version
- 09.4843.30ADA
- 09.4843.14ADA

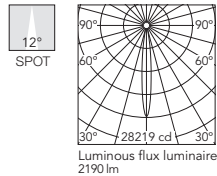

Beam Angle: 12°

h(m)	E(lx)	D(m)
1	28219	0.21
2	7055	0.41
3	3135	0.62
4	1764	0.82
5	1129	1.03

3000K - CRI 80

- On board dimmer
- 09.4841.30A
- 09.4841.14A
- Non Dimmable
- 09.4882.30A
- 09.4882.14A
- Dali Version
- 09.4841.30ADA
- 09.4841.14ADA

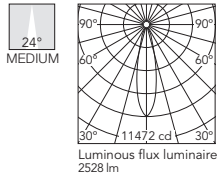

Beam Angle: 24°

h(m)	E(lx)	D(m)
1	11472	0.43
2	2868	0.86
3	1275	1.28
4	717	1.71
5	459	2.14

4000K - CRI 90

- On board dimmer included
- 09.4851.30A
- 09.4851.14A
- Non Dimmable
- 09.4883.30A
- 09.4883.14A
- Dali Version
- 09.4851.30ADA
- 09.4851.14ADA

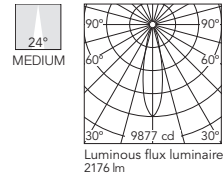

Beam Angle: 24°

h(m)	E(lx)	D(m)
1	9877	0.43
2	2469	0.86
3	1097	1.28
4	617	1.71
5	395	2.14

3000K - CRI 90

- On board dimmer
- 09.4844.30A
- 09.4844.14A
- Non Dimmable
- 09.4887.30A
- 09.4887.14A
- Dali Version
- 09.4844.30ADA
- 09.4844.14ADA

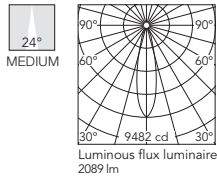

Beam Angle: 24°

h(m)	E(lx)	D(m)
1	9482	0.43
2	2370	0.86
3	1054	1.28
4	593	1.71
5	379	2.14

3000K - CRI 80

- On board dimmer
- 09.4842.30A
- 09.4842.14A
- Non Dimmable
- 09.4884.30A
- 09.4884.14A
- Dali Version
- 09.4842.30ADA
- 09.4842.14ADA

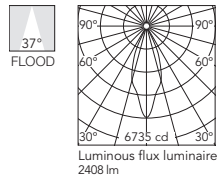

Beam Angle: 37°

h(m)	E(lx)	D(m)
1	6735	0.67
2	1684	1.34
3	748	2.01
4	421	2.69
5	269	3.36

4000K - CRI 90

- On board dimmer included
- 09.4852.30A
- 09.4852.14A
- Non Dimmable
- 09.4885.30A
- 09.4885.14A
- Dali Version
- 09.4852.30ADA
- 09.4852.14ADA

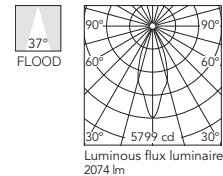

Beam Angle: 37°

h(m)	E(lx)	D(m)
1	5799	0.67
2	1450	1.34
3	644	2.01
4	362	2.69
5	232	3.36

3000K - CRI 90

- On board dimmer
- 09.4845.30A
- 09.4845.14A
- Non Dimmable
- 09.4888.30A
- 09.4888.14A
- Dali Version
- 09.4845.30ADA
- 09.4845.14ADA

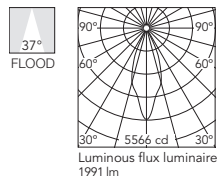

Beam Angle: 37°

h(m)	E(lx)	D(m)
1	5566	0.67
2	1392	1.34
3	618	2.01
4	348	2.69
5	223	3.36

UT SPOT

Ut Spot Track Ø86

Light Source: Phosphor LED 31W/34W - 2650 lm - 3000K/CRI 98 / 29W - 3000 lm - 4000K/CRI 80

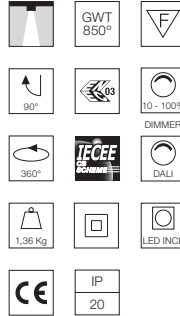
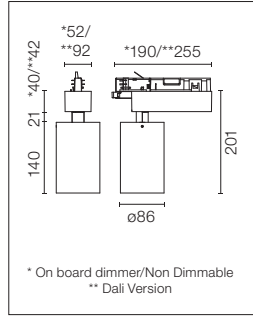

Strahler für 3-Phasen-Stromschiene mit LED-Lampe. Netzgerät mit 220-240V, 50-60Hz inbegriffen.

Spotlight to be installed on 3-phase track with LED light source. 220-240V, 50-60Hz power supply integrated.

3000K - CRI 98

On board dimmer

- ☐ 09.4243.30
- 09.4243.14
- ☐ 09.4286.30
- 09.4286.14
- ☐ 09.4243.30.DA
- 09.4243.14.DA

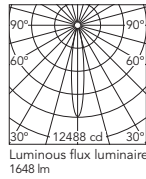

Beam Angle: 16°

h(m)	E(lx)	D(m)
1	12488	0.28
2	3122	0.55
3	1388	0.83
4	781	1.10
5	500	1.38

4000K - CRI 80

On board dimmer

- ☐ 09.4250.30
- 09.4250.14
- ☐ 09.4281.30
- 09.4281.14
- ☐ 09.4250.30.DA
- 09.4250.14.DA

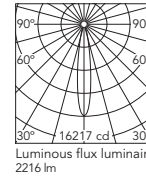

Beam Angle: 17°

h(m)	E(lx)	D(m)
1	16217	0.29
2	4054	0.58
3	1802	0.88
4	1014	1.17
5	649	1.46

3000K - CRI 98

On board dimmer

- ☐ 09.4244.30A
- 09.4244.14A
- ☐ 09.4287.30A
- 09.4287.14A
- ☐ 09.4244.30ADA
- 09.4244.14ADA

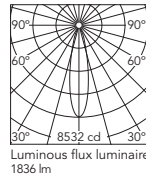

Beam Angle: 23°

h(m)	E(lx)	D(m)
1	8532	0.41
2	2133	0.82
3	948	1.23
4	533	1.64
5	341	2.05

4000K - CRI 80

On board dimmer

- ☐ 09.4251.30A
- 09.4251.14A
- ☐ 09.4283.30A
- 09.4283.14A
- ☐ 09.4251.30ADA
- 09.4251.14ADA

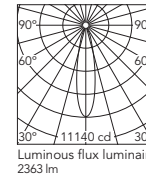

Beam Angle: 23°

h(m)	E(lx)	D(m)
1	11140	0.41
2	2785	0.81
3	1238	1.22
4	696	1.63
5	446	2.03

3000K - CRI 98

On board dimmer

- ☐ 09.4245.30
- 09.4245.14
- ☐ 09.4288.30
- 09.4288.14
- ☐ 09.4245.30.DA
- 09.4245.14.DA

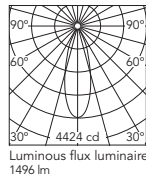

Beam Angle: 32°

h(m)	E(lx)	D(m)
1	4424	0.57
2	1106	1.15
3	492	1.72
4	276	2.29
5	177	2.87

4000K - CRI 80

On board dimmer

- ☐ 09.4252.30
- 09.4252.14
- ☐ 09.4285.30
- 09.4285.14
- ☐ 09.4252.30.DA
- 09.4252.14.DA

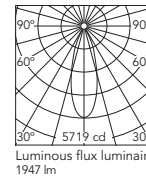

Beam Angle: 32°

h(m)	E(lx)	D(m)
1	5719	0.58
2	1430	1.15
3	635	1.73
4	357	2.31
5	229	2.89

UT SPOT

Ut Spot Track Multichip Ø86

Light Source: Top LED 11,5W - 850 lm - 3000K/CRI 90 / 11,5W - 950 lm - 3000K/CRI 80 / 11,5W - 1000 lm - 4000K/CRI 80

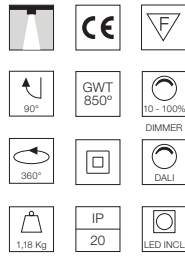
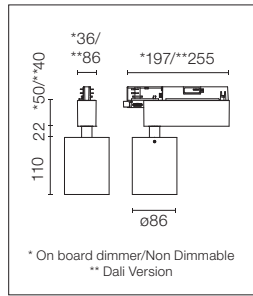

Strahler für 3-Phasen-Stromschiene mit LED-Lampe. Netzgerät mit 220-240V, 50-60Hz inbegriffen.

Spotlight to be installed on 3-phase track with LED light source. 220-240V, 50-60Hz power supply integrated.

Das Zubehör ist mit dieser Version nicht kompatibel.

The accessories are not compatible with this version.

3000K - CRI 80

On board dimmer

- 09.4980.30
- 09.4980.14

Non Dimmable

- 09.4983.30
- 09.4983.14

Dali Version

- 09.4980.30.DA
- 09.4980.14.DA

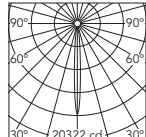

Luminous flux luminaire 776 lm

Beam Angle: 8°

h(m)	Ef(lx)	D(m)
1	20322	0.14
2	5081	0.27
3	2258	0.41
4	1270	0.54
5	813	0.68

4000K - CRI 80

On board dimmer

- 09.4982.30
- 09.4982.14

Non Dimmable

- 09.4985.30
- 09.4985.14

Dali Version

- 09.4982.30.DA
- 09.4982.14.DA

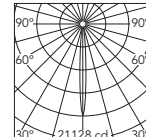

Luminous flux luminaire 807 lm

Beam Angle: 8°

h(m)	Ef(lx)	D(m)
1	21128	0.14
2	5282	0.27
3	2348	0.41
4	1321	0.54
5	845	0.68

3000K - CRI 90

On board dimmer

- 09.4981.30
- 09.4981.14

Non Dimmable

- 09.4984.30
- 09.4984.14

Dali Version

- 09.4981.30.DA
- 09.4981.14.DA

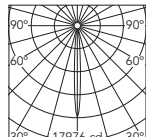

Luminous flux luminaire 687 lm

Beam Angle: 8°

h(m)	Ef(lx)	D(m)
1	17976	0.14
2	4494	0.27
3	1997	0.41
4	1124	0.54
5	719	0.68

Ut Spot Track Wall-Washer Ø86

Light Source: LED Array High Performances 33W - 3960 lm - 3000K/CRI 80 / 33W - 3250 lm - 3000K/CRI 90 / 33W - 3500 lm - 4000K/CRI 90

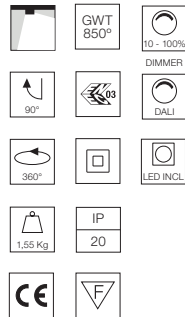
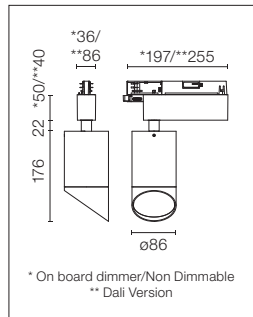

Strahler für 3-Phasen-Stromschiene mit LED-Lampe. Netzgerät mit 220-240V, 50-60Hz inbegriffen.

Spotlight to be installed on 3-phase track with LED light source. 220-240V, 50-60Hz power supply integrated.

3000K - CRI 80

On board dimmer

- 09.4950.30A
- 09.4950.14A

Non Dimmable

- 09.4951.30A
- 09.4951.14A

Dali Version

- 09.4950.30ADA
- 09.4950.14ADA

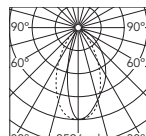

Luminous flux luminaire 2560 lm

Beam Angle: 50°

h(m)	Ef(lx)	D(m)
1	2596	0.98
2	649	1.97
3	288	2.95
4	162	3.94
5	104	4.92

4000K - CRI 90

On board dimmer

- 09.4956.30A
- 09.4956.14A

Non Dimmable

- 09.4957.30A
- 09.4957.14A

Dali Version

- 09.4956.30ADA
- 09.4956.14ADA

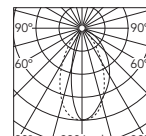

Luminous flux luminaire 2204 lm

Beam Angle: 50°

h(m)	Ef(lx)	D(m)
1	2236	0.98
2	559	1.97
3	248	2.95
4	140	3.94
5	89	4.92

3000K - CRI 90

On board dimmer

- 09.4953.30A
- 09.4953.14A

Non Dimmable

- 09.4954.30A
- 09.4954.14A

Dali Version

- 09.4953.30ADA
- 09.4953.14ADA

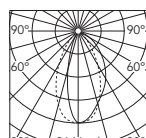

Luminous flux luminaire 2116 lm

Beam Angle: 50°

h(m)	Ef(lx)	D(m)
1	2146	0.98
2	537	1.97
3	238	2.95
4	134	3.94
5	86	4.92

UT PRO

UT Pro 150 GA-69

Light Source: LED Array 23,5W - 2300 lm - 3000K/CRI 80 / 23,5W - 1950 lm - 3000K/CRI 90 / 23,5W - 2009 lm - 4000K/CRI 90

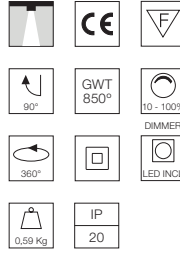
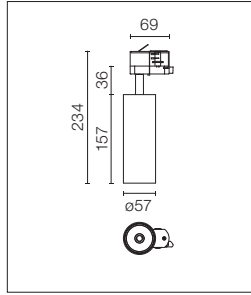

Scheinwerfer mit LED Lichtquelle zum Einbau in Standard-Dreiphasenschiene. Netzgerät 120-270V inbegriffen.

Bei den Versionen 40 sind der Schienenadapter, der Arm und der Hinterkopf schwarz. Bei den "All White" -Versionen sind der Schienenadapter, der Arm, der Hinterkopf und der Kopf weiß, nur der Blendschutzring bleibt schwarz.

Spotlight to be installed in standard 3-phase track with LED light source. 120-270V power supply integrated.

.40 versions come with the track adapter, the arm and the rear of the head in black. In the "All white" versions, the track adapter, the arm, the rear of the head and the head are white. Only the anti-glare ring is black.

Finishes Available



3000K - CRI 80 On board dimmer

- 09.7270.40A
- 09.7270.14A
- 09.7270.40A78

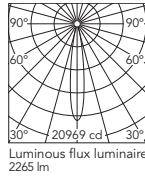

Beam Angle: 16°

h(m)	E(lx)	D(m)
1	20969	0.28
2	5242	0.56
3	2330	0.84
4	1311	1.12
5	839	1.40

Luminous flux luminaire 2265 lm

3000K - CRI 90 On board dimmer

- 09.7276.40A
- 09.7276.14A
- 09.7276.40A78

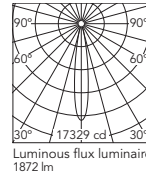

Beam Angle: 16°

h(m)	E(lx)	D(m)
1	17329	0.28
2	4332	0.56
3	1925	0.84
4	1083	1.12
5	693	1.40

Luminous flux luminaire 1872 lm

4000K - CRI 90 On board dimmer

- 09.7271.40A
- 09.7271.14A
- 09.7271.40A78

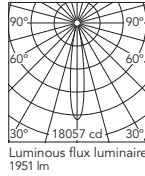

Beam Angle: 16°

h(m)	E(lx)	D(m)
1	18057	0.28
2	4514	0.56
3	2006	0.84
4	1129	1.12
5	722	1.40

Luminous flux luminaire 1951 lm

3000K - CRI 90 On board dimmer

- 09.7277.40A
- 09.7277.14A
- 09.7277.40A78

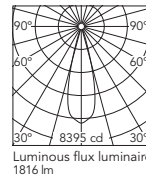

Beam Angle: 28°

h(m)	E(lx)	D(m)
1	8395	0.50
2	2099	1.00
3	933	1.50
4	525	2.00
5	336	2.50

Luminous flux luminaire 1816 lm

3000K - CRI 80 On board dimmer

- 09.7272.40A
- 09.7272.14A
- 09.7272.40A78

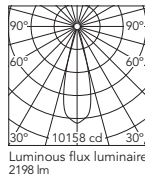

Beam Angle: 28°

h(m)	E(lx)	D(m)
1	10158	0.50
2	2540	1.00
3	1129	1.50
4	635	2.00
5	406	2.50

Luminous flux luminaire 2198 lm

4000K - CRI 90 On board dimmer

- 09.7273.40A
- 09.7273.14A
- 09.7273.40A78

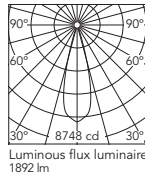

Beam Angle: 28°

h(m)	E(lx)	D(m)
1	8748	0.50
2	2187	1.00
3	972	1.50
4	547	2.00
5	350	2.50

Luminous flux luminaire 1892 lm

3000K - CRI 80 On board dimmer

- 09.7274.40A
- 09.7274.14A
- 09.7274.40A78

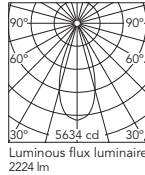

Beam Angle: 40°

h(m)	E(lx)	D(m)
1	5634	0.73
2	1408	1.46
3	626	2.18
4	352	2.91
5	225	3.64

Luminous flux luminaire 2224 lm

3000K - CRI 90 On board dimmer

- 09.7278.40A
- 09.7278.14A
- 09.7278.40A78

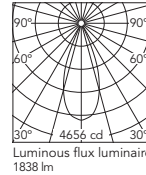

Beam Angle: 40°

h(m)	E(lx)	D(m)
1	4656	0.73
2	1164	1.46
3	517	2.18
4	291	2.91
5	186	3.64

Luminous flux luminaire 1838 lm

4000K - CRI 90 On board dimmer

- 09.7275.40A
- 09.7275.14A
- 09.7275.40A78

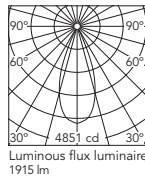

Beam Angle: 40°

h(m)	E(lx)	D(m)
1	4851	0.73
2	1213	1.46
3	539	2.18
4	303	2.91
5	194	3.64

Luminous flux luminaire 1915 lm

UT PRO

UT Pro 175 GA-69

Light Source: LED Array 35,3W - 3950 lm - 3000K/CRI 80 / 35,3W - 3250 lm - 3000K/CRI 90 / 35,3W - 3400 lm - 4000K/CRI 90

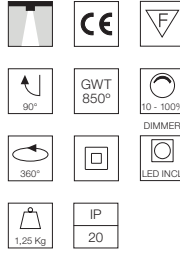
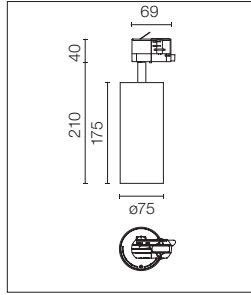

Finishes Available



Scheinwerfer mit LED Lichtquelle zum Einbau in Standard-Dreiphasenschiene. Netzgerät 120-270V inbegriffen.

Bei den Versionen 40 sind der Schienenadapter, der Arm und der Hinterkopf schwarz. Bei den "All White" -Versionen sind der Schienenadapter, der Arm, der Hinterkopf und der Kopf weiß, nur der Blendschutzring bleibt schwarz.

Spotlight to be installed in standard 3-phase track with LED light source. 120-270V power supply integrated.

.40 versions come with the track adapter, the arm and the rear of the head in black. In the "All white" versions, the track adapter, the arm, the rear of the head and the head are white. Only the anti-glare ring is black.

3000K - CRI 80 On board dimmer

- 09.7310.40
- 09.7310.14
- All White
- 09.7310.40.78

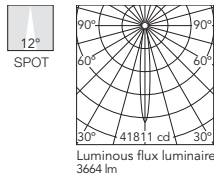

Beam Angle: 12°

h(m)	E(lx)	D(m)
1	41811	0.21
2	10453	0.41
3	4646	0.62
4	2613	0.83
5	1672	1.03

3000K - CRI 90 On board dimmer

- 09.7311.40
- 09.7311.14
- All White
- 09.7311.40.78

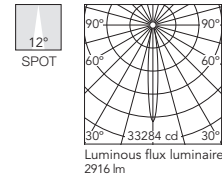

Beam Angle: 12°

h(m)	E(lx)	D(m)
1	33284	0.21
2	8321	0.41
3	3698	0.62
4	2080	0.83
5	1331	1.03

4000K - CRI 90 On board dimmer

- 09.7312.40
- 09.7312.14
- All White
- 09.7312.40.78

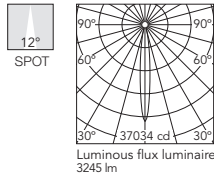

Beam Angle: 12°

h(m)	E(lx)	D(m)
1	37034	0.21
2	9258	0.41
3	4115	0.62
4	2315	0.83
5	1481	1.03

3000K - CRI 80 On board dimmer

- 09.7313.40
- 09.7313.14
- All White
- 09.7313.40.78

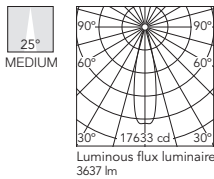

Beam Angle: 25°

h(m)	E(lx)	D(m)
1	17633	0.44
2	4408	0.88
3	1959	1.32
4	1102	1.76
5	705	2.20

3000K - CRI 90 On board dimmer

- 09.7314.40
- 09.7314.14
- All White
- 09.7314.40.78

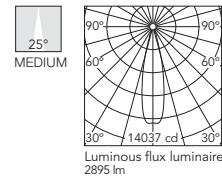

Beam Angle: 25°

h(m)	E(lx)	D(m)
1	14037	0.44
2	3509	0.88
3	1560	1.32
4	877	1.76
5	561	2.20

4000K - CRI 90 On board dimmer

- 09.7315.40
- 09.7315.14
- All White
- 09.7315.40.78

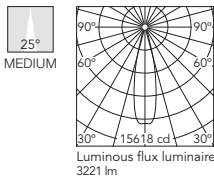

Beam Angle: 25°

h(m)	E(lx)	D(m)
1	15618	0.44
2	3904	0.88
3	1735	1.32
4	976	1.76
5	625	2.20

3000K - CRI 80 On board dimmer

- 09.7316.40
- 09.7316.14
- All White
- 09.7316.40.78

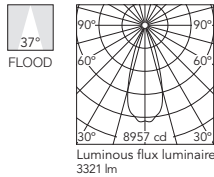

Beam Angle: 37°

h(m)	E(lx)	D(m)
1	8957	0.66
2	2239	1.32
3	995	1.98
4	560	2.65
5	358	3.31

3000K - CRI 90 On board dimmer

- 09.7317.40
- 09.7317.14
- All White
- 09.7317.40.78

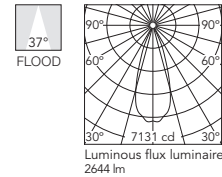

Beam Angle: 37°

h(m)	E(lx)	D(m)
1	7131	0.66
2	1783	1.32
3	792	1.98
4	446	2.65
5	285	3.31

4000K - CRI 90 On board dimmer

- 09.7318.40
- 09.7318.14
- All White
- 09.7318.40.78

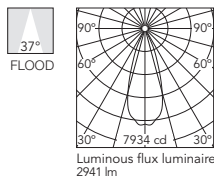

Beam Angle: 37°

h(m)	E(lx)	D(m)
1	7934	0.66
2	1983	1.32
3	882	1.98
4	496	2.65
5	317	3.31

UT PRO

UT Pro 175 Lens GA-69

Light Source: LED Array 35,3W - 3950 lm - 3000K/CRI 80 / 35,3W - 3250 lm - 3000K/CRI 90 / 35,3W - 3400 lm - 4000K/CRI 90

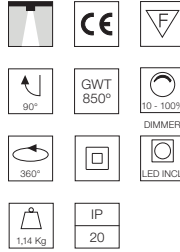
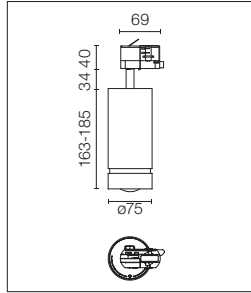

Scheinwerfer mit LED Lichtquelle zum Einbau in Standard-Dreiphasenschiene. Besitzt eine verstellbare Linse, mit der man den Öffnungswinkel von 13° bis 56° verändern kann. Netzgerät 120-270V inbegriffen.

Spotlight to be installed in standard 3-phase track with LED light source. Includes adjustable lens allowing opening angle calibration from 13° to 56°. 120-270V power supply integrated.

Bei den Versionen 40 sind der Schienenadapter, der Arm und der Hinterkopf schwarz. Bei den "All White" -Versionen sind der Schienenadapter, der Arm, der Hinterkopf und der Kopf weiß, nur der Blendschutzring bleibt schwarz.

.40 versions come with the track adapter, the arm and the rear of the head in black. In the "All white" versions, the track adapter, the arm, the rear of the head and the head are white. Only the anti-glare ring is black.

Finishes Available



3000K - CRI 80 On board dimmer

- 09.7373.40
- 09.7373.14
- All White
- 09.7373.40.78

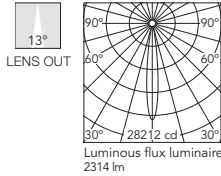

Beam Angle: 13°

h(m)	Ef(lx)	D(m)
1	28212	0.23
2	7053	0.46
3	3135	0.70
4	1763	0.93
5	1128	1.16

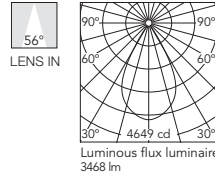

Beam Angle: 56°

h(m)	Ef(lx)	D(m)
1	4649	1.07
2	1162	2.14
3	517	3.21
4	291	4.29
5	186	5.36

3000K - CRI 90 On board dimmer

- 09.7374.40
- 09.7374.14
- All White
- 09.7374.40.78

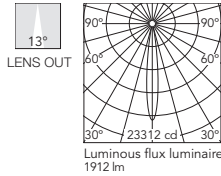

Beam Angle: 13°

h(m)	Ef(lx)	D(m)
1	23312	0.23
2	5828	0.46
3	2590	0.70
4	1457	0.93
5	932	1.16

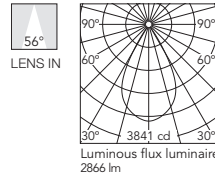

Beam Angle: 56°

h(m)	Ef(lx)	D(m)
1	3841	1.07
2	960	2.14
3	427	3.21
4	240	4.29
5	154	5.36

4000K - CRI 90 On board dimmer

- 09.7375.40
- 09.7375.14
- All White
- 09.7375.40.78

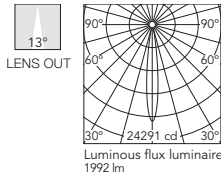

Beam Angle: 13°

h(m)	Ef(lx)	D(m)
1	24291	0.23
2	6073	0.46
3	2699	0.70
4	1518	0.93
5	972	1.16

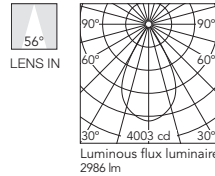

Beam Angle: 56°

h(m)	Ef(lx)	D(m)
1	4003	1.07
2	1001	2.14
3	445	3.21
4	250	4.29
5	160	5.36

UT Pro Wall-Washer GA-69 (Dali GA-600)

Light Source: Top LED 25,5W - 2700 lm - 3000K/CRI 90 / 25,5W - 2900 lm - 4000K/CRI 90

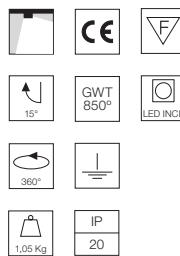
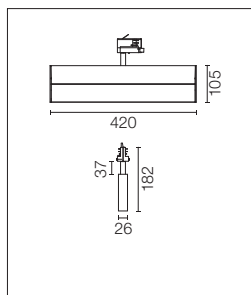

Lichtmodul Wall-Washer mit LED Lichtquelle zum Einbau in Standard-Dreiphasenschiene. Netzgerät 220-240V inbegriffen. Für die DALI-Version benötigen Sie dimmbare Schienen (siehe Kapitel "Tracks").

Wall-Washer lighting module to be installed in standard 3-phase track with LED light source. 220-240V power supply integrated. DALI version requires dimmable tracks (please refer to the "Tracks" chapter).

Bei den Versionen 40 sind der Schienenadapter, der Arm und der Hinterkopf schwarz. Bei den "All White" -Versionen sind der Schienenadapter, der Arm, der Hinterkopf und der Kopf weiß, nur der Blendschutzring bleibt schwarz.

.40 versions come with the track adapter, the arm and the rear of the head in black. In the "All white" versions, the track adapter, the arm, the rear of the head and the head are white. Only the anti-glare ring is black.

Finishes Available



3000K - CRI 90 Non Dimmable

- 09.7504.40
- 09.7504.14
- All White
- 09.7504.40.78

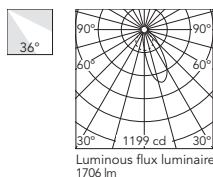

Beam Angle: 36°

h(m)	Ef(lx)	D(m)
1	1199	0.76
2	300	1.52
3	133	2.34
4	75	3.12
5	48	3.93

4000K - CRI 90 Non Dimmable

- 09.7505.40
- 09.7505.14
- All White
- 09.7505.40.78

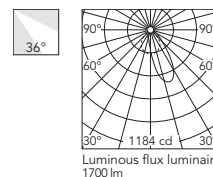

Beam Angle: 36°

h(m)	Ef(lx)	D(m)
1	1184	0.76
2	296	1.52
3	132	2.28
4	74	3.04
5	47	3.80

Dali Version

- 09.7504.40.DA
- 09.7504.14.DA
- All White
- 09.7504.40.YU

Dali Version

- 09.7505.40.DA
- 09.7505.14.DA
- All White
- 09.7505.40.YU

UT SPOT & PRO

Zubehör / Accessories

Querabschirmung, Linsen und Honeycomb können ohne Befestigungszubehör direkt in den Leuchtenkopf eingesetzt werden. Honeycomb + Linse können gleichzeitig verwendet werden.

Screening crosspiece, lenses and honeycomb directly installable on the head of the luminaire without needing any fastening accessory. Installation compatible with honeycomb + lense at the same time.

UT Spot Ø57 / UT Pro 150

Querabschirmung
Screening crosspiece  08.8429.00

Elliptische linse
Elliptical lens  08.8431.00

Floodlinse
Flood lens  08.8432.00

For Spot & Medium optics

Honeycomb
Honeycomb  08.8428.00

Konische Abschirmung
Snoot shielding cone  08.0526.00
08.0526.40
08.0526.BW

UT Pro 175

Querabschirmung
Screening crosspiece  08.9108.00

Elliptische linse
Elliptical lens  08.9109.00

Floodlinse
Flood lens  08.9110.00

Honeycomb
Honeycomb  08.9107.00

Konische Abschirmung
Snoot shielding cone  08.9111.00

Zubehör / Accessories

Querabschirmung, Linsen und Honeycomb können ohne Befestigungszubehör direkt in den Leuchtenkopf eingesetzt werden. **UT Spot Ø86:** Honeycomb + Linse können gleichzeitig verwendet werden.

UT Spot Ø86 Multichip: Das Zubehör ist mit dieser Version nicht kompatibel.

Screening crosspiece, lenses and Honeycomb directly installable on the head of the luminaire without needing any fastening accessory.

UT Spot Ø86: Installation compatible with Honeycomb + Linse at the same time.

UT Spot Ø86 Multichip: The accessories are not compatible with this version.

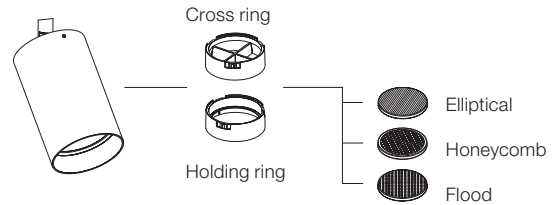

UT Spot Ø86

Haltering
Holding ring  08.8410.00

UT Spot Ø86 Phosphor LED / UT Spot Ø86 LED Array

Querabschirmung
Screening crosspiece  08.8411.00

UT Spot Ø86 LED Array

Elliptische linse
Elliptical lens  08.8163.68

Floodlinse
Flood lens  08.8175.68

For Spot & Medium optics

Honeycomb
Honeycomb  08.8495.14

SOLID PURE

DESIGNED BY KNUD HOLSCHER

TRACK

CEILING



LIGHT SOURCE

LED ARRAY
23W
2747 lm
3000K/CRI 80
23W
2231 lm
3000K/CRI 90
23W
2865 lm
4000K/CRI 80

LIGHT SOURCE

LED ARRAY
30W
3516 lm
3000K/CRI 80
30W
2855 lm
3000K/CRI 90
30W
3667 lm
4000K/CRI 80

LIGHT SOURCE

LED ARRAY
35W
4321 lm
3000K/CRI 80
35W
3509 lm
3000K/CRI 90
35W
4508 lm
4000K/CRI 80

□ 30 Weiss
30 White

■ 14 Schwarz
14 Black



Drehbar um 360° und schwenkbar 190°.
Can be rotated 360° and swivelled 190°.

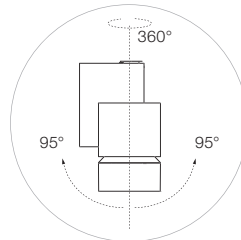

reddot design award
winner 2013

Produktbeschreibung

Innenraumleuchte für die Installation auf 3-Phasenstromschiene oder an Decken bzw. Wänden. Erhältlich für Lichtquellen mit hocheffizienter LED-Technologie sowie in DALI- und Nicht-DALI-Version. Der optische Leuchtenkörper sowie die Aufnahme der Netzgeräte sind aus mit Hochdruck fließgepresstem Aluminium mit Pulverbeschichtung in Weiß, Grau oder Schwarz gefertigt. Der Befestigungsring für die Reflektoren besteht aus schwarzem thermoplastischem Material und ist innen mit einem Zubehörelement ausgestattet, das Farbfilter und Wabenraaster zur Vermeidung von Blendung aufnehmen kann. Die Ausführung für die Schienenmontage enthält einen Drehstromschienen-Adapter. Die korrekte Funktionsweise während der ganzen Lebensdauer des LED-Moduls wird dank eines innovativen Designs des wärmeableitenden Systems gewährleistet, das innen eine konstante Luftzirkulation ermöglicht. Zu diesem Zweck kommen Lösungen mit passiven Kühlern (Versionen 23/30/35W) und aktiven Kühlern (Version 53W), je nach benötigtem Zirkulationsluftstrom, zum Einsatz.

Reflektoren

Alle Optiken bestehen aus hochreinem Aluminium mit Spiegel-Finish. Symmetrischer drehbarer Kugelreflektor. Die Leuchte ist mit drei verschiedenen Typen von Reflektoren erhältlich: Spot, Medium y Flood.

Betriebsgerät

Netzteil für konstante Stromzufuhr mit oder ohne DALI-Steuerung 220/240V eingeschlossen.

Zubehör

- Honeycomb.
- Farbfilter.

Zusatzinformationen

Möglichkeit der Arretierung des Lichtstrahls sowohl horizontal (Drehung 360° an der Vertikalachse) als auch vertikal (190° an der Horizontalachse). Erhältlich als DALI-Ausführung zur Schienen- oder Deckenmontage. Schutzart IP20. Schutzklasse I. Auf normal entflammaren Oberflächen einsetzbar. Die FLOS Schienenleuchten wurden für 3-Phasen Standardschienen, die von FLOS empfohlen werden, entwickelt und umfassend getestet. Ihre Kompatibilität ist mit denen von Nordic Aluminium und Eutrac produzierten 3-Phasen-Schienen garantiert. Wenn Sie die Kompatibilität mit anderen Schienen überprüfen möchten, kontaktieren Sie bitte FLOS vor der Installation. Die FLOS 3-phasen DALI-Schienenleuchten sind für Pulse DALI Protokoll von Nordic Aluminium entwickelt.

Qualitätszeichen

Das Gerät entspricht der europäischen technischen Norm EN60598-1 und den entsprechenden Zusatzregelungen.

Description

A luminaire for indoor use to be mounted on three-phase track or on ceilings/walls, available in high power LED technology light sources and in DALI and non-DALI versions. The optical housing of the luminaire, as well as the container of the power supply equipment, is manufactured in high-pressure injected aluminium, with white, grey or black finishes. The reflector fastening ring houses an accessory-holder element where chromatic filters and honeycomb type anti-glare elements can be housed. The perfect operation of the LED module is guaranteed thanks to its heat dissipation system, which permits constant recirculation of the air on the inside. To this end, solutions with passive radiators (23/30/35W versions) and active radiators (53W version) are used depending on the required air recirculation flow.

Reflectors

All optics are made of superpure aluminium with specular finish. Symmetrical circular rotary system. Available in 3 optics: spot, medium y flood.

Power Supply

Not dimmable or dimmable Dali 220/240V, constant current, power supply included.

Accessories

- Honeycomb.
- Chromatic filters.

Additional Information

Block system to fix the lightbeam in horizontal (360° rotation on vertical edge) as well as vertical (190° on horizontal edge). DALI version for track and surface mounting is available. IP20 protection grade. Insulation class I. Suitable for installation on normally inflammable surfaces. FLOS three-phase lighting track luminaires are designed and fully tested for tracks recommended by FLOS. Compatibility is guaranteed with three-phase track produced by Nordic Aluminium and Eutrac. To verify compatibility with any other track, please contact FLOS before installation. FLOS three-phase DALI track luminaires are designed for Pulse DALI from Nordic Aluminium.

Standard Compliance and Quality Marks

EN60598-1 European Technical Standards and any subsequent additions.



Ceiling



Track

SOLID PURE

Solid Pure Track

Light Source: LED Array 23W - 2747 lm - 3000K/CRI 80

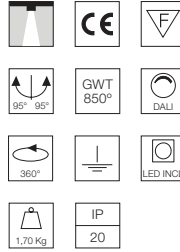
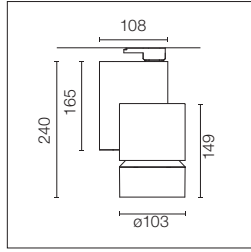

Strahler für 3-Phasen-Stromschiene mit LED-Lampe. Netzgerät mit 220-240V, 50-60Hz im Lieferumfang enthalten.

Spotlight to be installed on 3-phase track with LED light source. 220-240V, 50-60Hz power supply included.

- Non Dimmable
 09.2888.30
 09.2888.14
 Dali Version
 09.2888.30.DA
 09.2888.14.DA

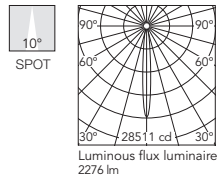

Beam Angle: 10°

h(m)	E(lx)	D(m)
1	28511	0.18
2	7128	0.35
3	3168	0.53
4	1782	0.71
5	1140	0.88

- Non Dimmable
 09.2890.30
 09.2890.14
 Dali Version
 09.2890.30.DA
 09.2890.14.DA

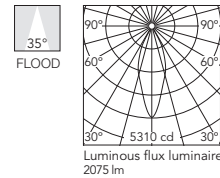

Beam Angle: 35°

h(m)	E(lx)	D(m)
1	5310	0.64
2	1327	1.27
3	590	1.91
4	332	2.54
5	212	3.18

- Non Dimmable
 09.2889.30
 09.2889.14
 Dali Version
 09.2889.30.DA
 09.2889.14.DA

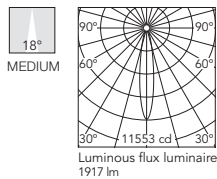

Beam Angle: 18°

h(m)	E(lx)	D(m)
1	11553	0.31
2	2888	0.62
3	1284	0.93
4	722	1.24
5	462	1.55

Solid Pure Track

Light Source: LED Array 30W - 3516 lm - 3000K/CRI 80 / 35W - 4321 lm - 3000K/CRI 80

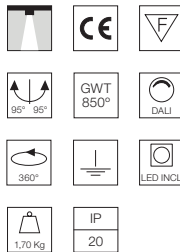
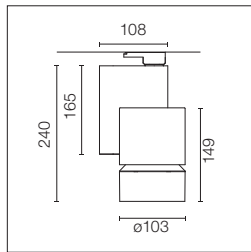

Strahler für 3-Phasen-Stromschiene mit LED-Lampe. Netzgerät mit 220-240V, 50-60Hz im Lieferumfang enthalten.

Spotlight to be installed on 3-phase track with LED light source. 220-240V, 50-60Hz power supply included.

- 3000K - CRI 80**
 30W - 3516 lm
 Non Dimmable
 09.2870.30
 09.2870.14
 Dali Version
 09.2870.30.DA
 09.2870.14.DA

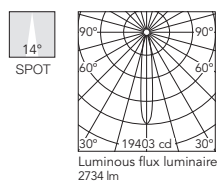

Beam Angle: 14°

h(m)	E(lx)	D(m)
1	19403	0.25
2	4851	0.51
3	2156	0.76
4	1213	1.01
5	776	1.27

- 3000K - CRI 80**
 35W - 4321 lm
 Non Dimmable
 09.2953.30
 09.2953.14
 Dali Version
 09.2953.30.DA
 09.2953.14.DA

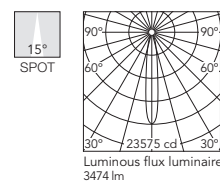

Beam Angle: 15°

h(m)	E(lx)	D(m)
1	23575	0.26
2	5894	0.53
3	2619	0.79
4	1473	1.05
5	943	1.31

- 3000K - CRI 80**
 30W - 3516 lm
 Non Dimmable
 09.2871.30
 09.2871.14
 Dali Version
 09.2871.30.DA
 09.2871.14.DA

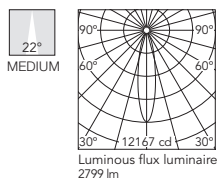

Beam Angle: 22°

h(m)	E(lx)	D(m)
1	12167	0.39
2	3042	0.79
3	1352	1.18
4	760	1.57
5	487	1.97

- 3000K - CRI 80**
 35W - 4321 lm
 Non Dimmable
 09.2954.30
 09.2954.14
 Dali Version
 09.2954.30.DA
 09.2954.14.DA

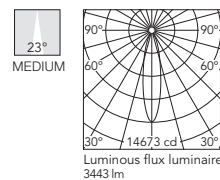

Beam Angle: 23°

h(m)	E(lx)	D(m)
1	14673	0.40
2	3668	0.80
3	1630	1.20
4	917	1.59
5	587	1.99

- 3000K - CRI 80**
 30W - 3516 lm
 Non Dimmable
 09.2872.30
 09.2872.14
 Dali Version
 09.2872.30.DA
 09.2872.14.DA

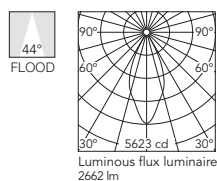

Beam Angle: 44°

h(m)	E(lx)	D(m)
1	5623	0.80
2	1406	1.61
3	625	2.41
4	351	3.22
5	225	4.02

- 3000K - CRI 80**
 35W - 4321 lm
 Non Dimmable
 09.2955.30
 09.2955.14
 Dali Version
 09.2955.30.DA
 09.2955.14.DA

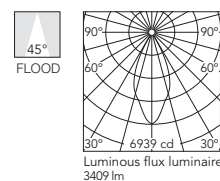

Beam Angle: 45°

h(m)	E(lx)	D(m)
1	6939	0.83
2	1735	1.65
3	771	2.48
4	434	3.31
5	278	4.13

SOLID PURE

Solid Pure Ceiling

Light Source: LED Array 23W - 2747 lm - 3000K/CRI 80

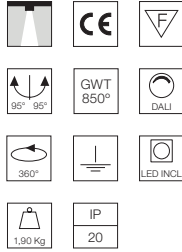
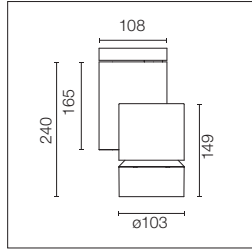

Decken- oder Wandstrahler mit LED-Lampe. Netzgerät mit 220-240V, 50-60 Hz im Lieferumfang enthalten.

Spotlight to be installed on ceiling/wall with LED light source. 220-240V, 50-60Hz power supply included.

- Non Dimmable
 09.2894.30
 09.2894.14
 Dali Version
 09.2894.30.DA
 09.2894.14.DA

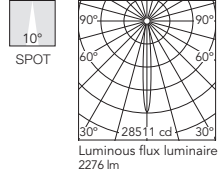

- Non Dimmable
 09.2896.30
 09.2896.14
 Dali Version
 09.2896.30.DA
 09.2896.14.DA

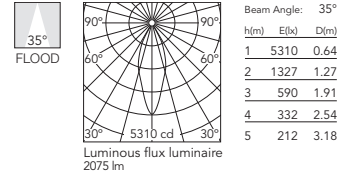

- Non Dimmable
 09.2895.30
 09.2895.14
 Dali Version
 09.2895.30.DA
 09.2895.14.DA

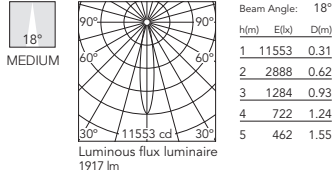

Solid Pure Ceiling

Light Source: LED Array 30W - 3516 lm - 3000K/CRI 80 / 35W - 4321 lm - 3000K/CRI 80

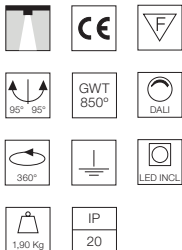
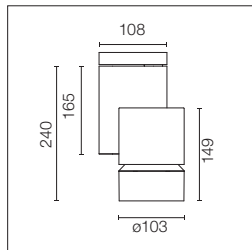

Decken- oder Wandstrahler mit LED-Lampe. Netzgerät mit 220-240V, 50-60 Hz im Lieferumfang enthalten.

Spotlight to be installed on ceiling/wall with LED light source. 220-240V, 50-60Hz power supply included.

- 3000K - CRI 80**
 30W - 3516 lm
 Non Dimmable
 09.2876.30
 09.2876.14
 Dali Version
 09.2876.30.DA
 09.2876.14.DA

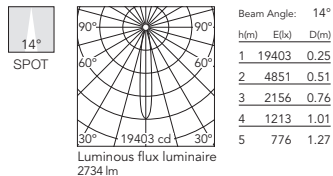

- 3000K - CRI 80**
 35W - 4321 lm
 Non Dimmable
 09.2956.30
 09.2956.14
 Dali Version
 09.2956.30.DA
 09.2956.14.DA

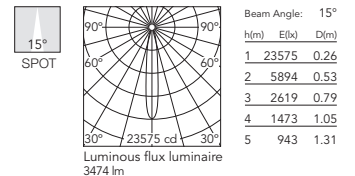

- 3000K - CRI 80**
 30W - 3516 lm
 Non Dimmable
 09.2877.30
 09.2877.14
 Dali Version
 09.2877.30.DA
 09.2877.14.DA

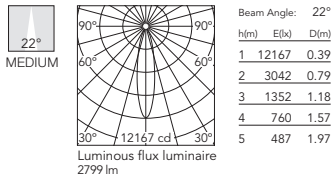

- 3000K - CRI 80**
 35W - 4321 lm
 Non Dimmable
 09.2957.30
 09.2957.14
 Dali Version
 09.2957.30.DA
 09.2957.14.DA

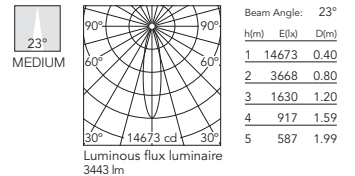

- 3000K - CRI 80**
 30W - 3516 lm
 Non Dimmable
 09.2878.30
 09.2878.14
 Dali Version
 09.2878.30.DA
 09.2878.14.DA

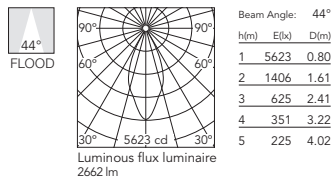

- 3000K - CRI 80**
 35W - 4321 lm
 Non Dimmable
 09.2958.30
 09.2958.14
 Dali Version
 09.2958.30.DA
 09.2958.14.DA

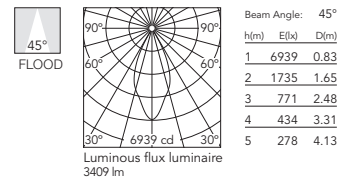

SOLID PURE

Solid Pure Track

Light Source: LED Array 23W - 2231 lm - 3000K/CRI 90

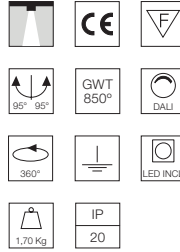
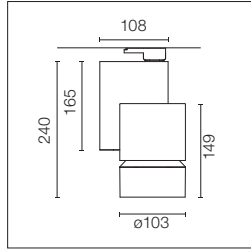

Strahler für 3-Phasen-Stromschiene mit LED-Lampe. Netzgerät mit 220-240V, 50-60Hz im Lieferumfang enthalten.

Spotlight to be installed on 3-phase track with LED light source. 220-240V, 50-60Hz power supply included.

- Non Dimmable
 09.2885.30
 09.2885.14
 Dali Version
 09.2885.30.DA
 09.2885.14.DA

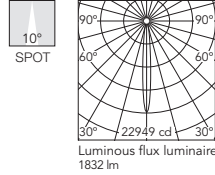

- Non Dimmable
 09.2887.30
 09.2887.14
 Dali Version
 09.2887.30.DA
 09.2887.14.DA

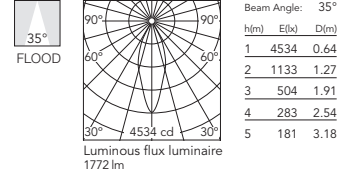

- Non Dimmable
 09.2886.30
 09.2886.14
 Dali Version
 09.2886.30.DA
 09.2886.14.DA

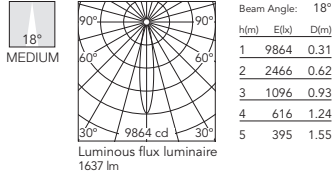

Solid Pure Track

Light Source: LED Array 30W - 2855 lm - 3000K/CRI 90 / 35W - 3509 lm - 3000K/CRI 90

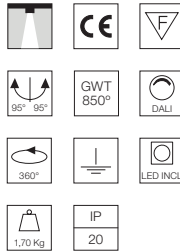
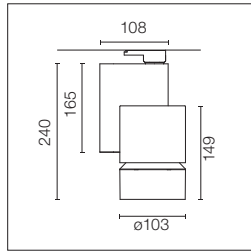

Strahler für 3-Phasen-Stromschiene mit LED-Lampe. Netzgerät mit 220-240V, 50-60Hz im Lieferumfang enthalten.

Spotlight to be installed on 3-phase track with LED light source. 220-240V, 50-60Hz power supply included.

- 3000K - CRI 90**
 30W - 2855 lm
 Non Dimmable
 09.2997.30
 09.2997.14
 Dali Version
 09.2997.30.DA
 09.2997.14.DA

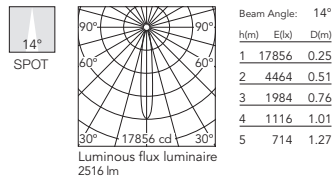

- 3000K - CRI 90**
 35W - 3509 lm
 Non Dimmable
 09.2991.30
 09.2991.14
 Dali Version
 09.2991.30.DA
 09.2991.14.DA

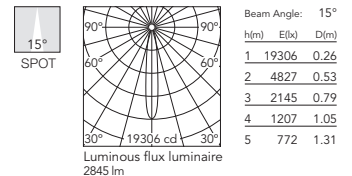

- 3000K - CRI 90**
 30W - 2855 lm
 Non Dimmable
 09.2998.30
 09.2998.14
 Dali Version
 09.2998.30.DA
 09.2998.14.DA

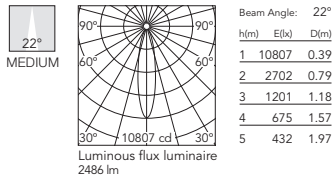

- 3000K - CRI 90**
 35W - 3509 lm
 Non Dimmable
 09.2992.30
 09.2992.14
 Dali Version
 09.2992.30.DA
 09.2992.14.DA

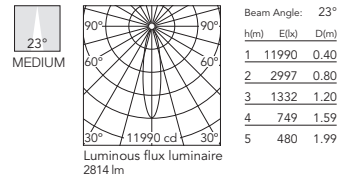

- 3000K - CRI 90**
 30W - 2855 lm
 Non Dimmable
 09.2999.30
 09.2999.14
 Dali Version
 09.2999.30.DA
 09.2999.14.DA

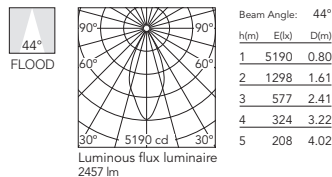

- 3000K - CRI 90**
 35W - 3509 lm
 Non Dimmable
 09.2993.30
 09.2993.14
 Dali Version
 09.2993.30.DA
 09.2993.14.DA

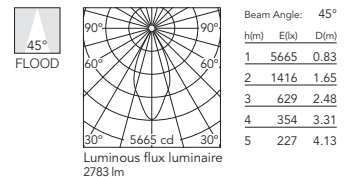

SOLID PURE

Solid Pure Ceiling

Light Source: LED Array 23W - 2231 lm - 3000K/CRI 90

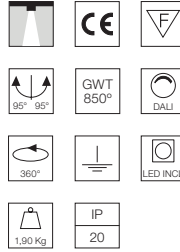
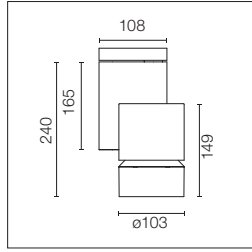

Decken- oder Wandstrahler mit LED-Lampe. Netzgerät mit 220-240V, 50-60 Hz im Lieferumfang enthalten.

Spotlight to be installed on ceiling/wall with LED light source. 220-240V, 50-60Hz power supply included.

- Non Dimmable
 09.2891.30
 09.2891.14
 Dali Version
 09.2891.30.DA
 09.2891.14.DA

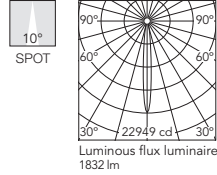

- Non Dimmable
 09.2893.30
 09.2893.14
 Dali Version
 09.2893.30.DA
 09.2893.14.DA

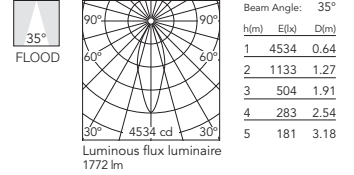

- Non Dimmable
 09.2892.30
 09.2892.14
 Dali Version
 09.2892.30.DA
 09.2892.14.DA

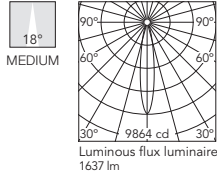

Solid Pure Ceiling

Light Source: LED Array 30W - 2855 lm - 3000K/CRI 90 / 35W - 3509 lm - 3000K/CRI 90

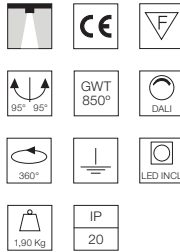
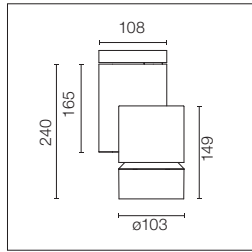

Decken- oder Wandstrahler mit LED-Lampe. Netzgerät mit 220-240V, 50-60 Hz im Lieferumfang enthalten.

Spotlight to be installed on ceiling/wall with LED light source. 220-240V, 50-60Hz power supply included.

- 3000K - CRI 90**
 30W - 2855 lm
 Non Dimmable
 09.2873.30
 09.2873.14
 Dali Version
 09.2873.30.DA
 09.2873.14.DA

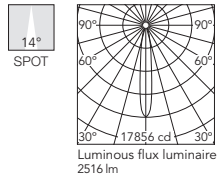

- 3000K - CRI 90**
 35W - 3509 lm
 Non Dimmable
 09.2994.30
 09.2994.14
 Dali Version
 09.2994.30.DA
 09.2994.14.DA

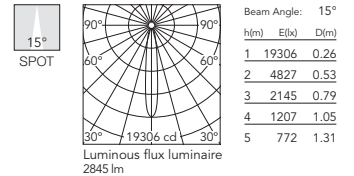

- 3000K - CRI 90**
 30W - 2855 lm
 Non Dimmable
 09.2874.30
 09.2874.14
 Dali Version
 09.2874.30.DA
 09.2874.14.DA

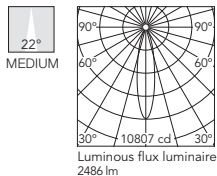

- 3000K - CRI 90**
 35W - 3509 lm
 Non Dimmable
 09.2995.30
 09.2995.14
 Dali Version
 09.2995.30.DA
 09.2995.14.DA

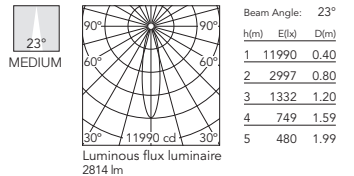

- 3000K - CRI 90**
 30W - 2855 lm
 Non Dimmable
 09.2875.30
 09.2875.14
 Dali Version
 09.2875.30.DA
 09.2875.14.DA

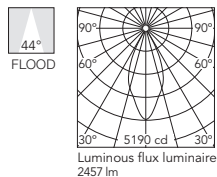

- 3000K - CRI 90**
 35W - 3509 lm
 Non Dimmable
 09.2996.30
 09.2996.14
 Dali Version
 09.2996.30.DA
 09.2996.14.DA

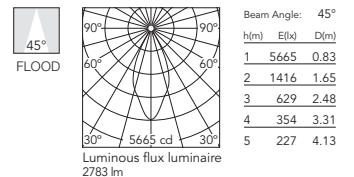

SOLID PURE

Solid Pure Track

Light Source: LED Array 23W - 2865 lm - 4000K/CRI 80

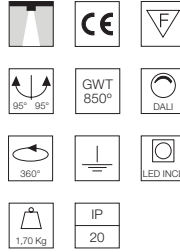
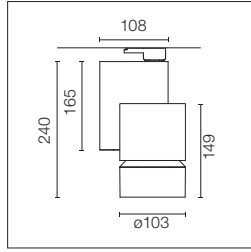

Strahler für 3-Phasen-Stromschiene mit LED-Lampe. Netzgerät mit 220-240V, 50-60Hz im Lieferumfang enthalten.

Spotlight to be installed on 3-phase track with LED light source. 220-240V, 50-60Hz power supply included.

- Non Dimmable
 09.2897.30
 09.2897.14
 Dali Version
 09.2897.30.DA
 09.2897.14.DA

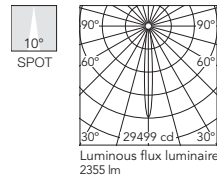

- Non Dimmable
 09.2899.30
 09.2899.14
 Dali Version
 09.2899.30.DA
 09.2899.14.DA

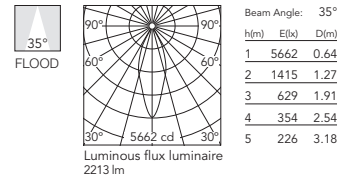

- Non Dimmable
 09.2898.30
 09.2898.14
 Dali Version
 09.2898.30.DA
 09.2898.14.DA

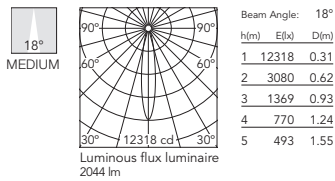

Solid Pure Track

Light Source: LED Array 30W - 3667 lm - 4000K/CRI 80 / 35W - 4508 lm - 4000K/CRI 80

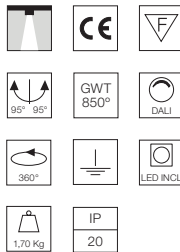
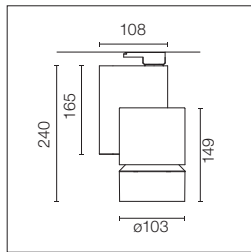

Strahler für 3-Phasen-Stromschiene mit LED-Lampe. Netzgerät mit 220-240V, 50-60Hz im Lieferumfang enthalten.

Spotlight to be installed on 3-phase track with LED light source. 220-240V, 50-60Hz power supply included.

- 4000K - CRI 80**
 30W - 3667 lm
 Non Dimmable
 09.2879.30
 09.2879.14
 Dali Version
 09.2879.30.DA
 09.2879.14.DA

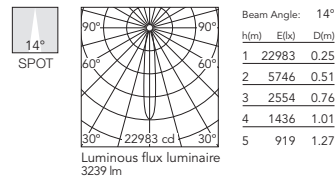

- 4000K - CRI 80**
 35W - 4508 lm
 Non Dimmable
 09.2959.30
 09.2959.14
 Dali Version
 09.2959.30.DA
 09.2959.14.DA

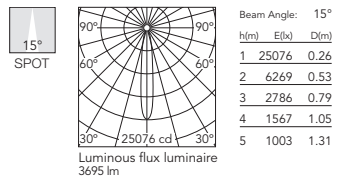

- 4000K - CRI 80**
 30W - 3667 lm
 Non Dimmable
 09.2880.30
 09.2880.14
 Dali Version
 09.2880.30.DA
 09.2880.14.DA

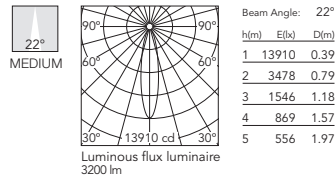

- 4000K - CRI 80**
 35W - 4508 lm
 Non Dimmable
 09.2960.30
 09.2960.14
 Dali Version
 09.2960.30.DA
 09.2960.14.DA

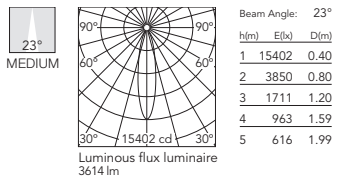

- 4000K - CRI 80**
 30W - 3667 lm
 Non Dimmable
 09.2881.30
 09.2881.14
 Dali Version
 09.2881.30.DA
 09.2881.14.DA

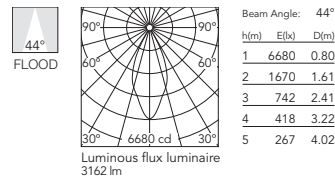

- 4000K - CRI 80**
 35W - 4508 lm
 Non Dimmable
 09.2961.30
 09.2961.14
 Dali Version
 09.2961.30.DA
 09.2961.14.DA

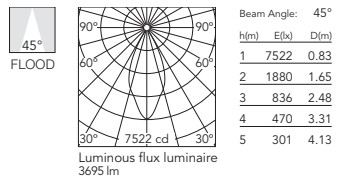

SOLID PURE

Solid Pure Ceiling

Light Source: LED Array 23W - 2865 lm - 4000K/CRI 80

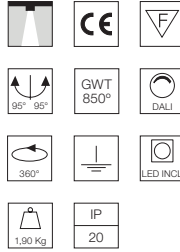
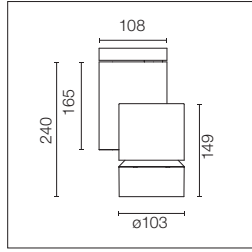

Decken- oder Strahler mit LED-Lampe. Netzgerät mit 220-240V, 50-60 Hz im Lieferumfang enthalten.

Spotlight to be installed on ceiling with LED light source. 220-240V, 50-60Hz power supply included.

- Non Dimmable
- 09.2865.30
 - 09.2865.14
- Dali Version
- 09.2865.30.DA
 - 09.2865.14.DA

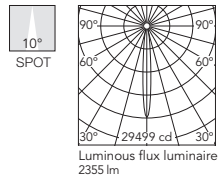

Beam Angle: 10°

h(m)	E(lx)	D(m)
1	29499	0.18
2	7375	0.35
3	3278	0.53
4	1844	0.71
5	1180	0.88

- Non Dimmable
- 09.2867.30
 - 09.2867.14
- Dali Version
- 09.2867.30.DA
 - 09.2867.14.DA

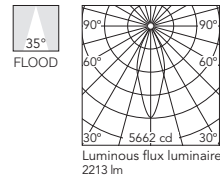

Beam Angle: 35°

h(m)	E(lx)	D(m)
1	5662	0.64
2	1415	1.27
3	629	1.91
4	354	2.54
5	226	3.18

- Non Dimmable
- 09.2866.30
 - 09.2866.14
- Dali Version
- 09.2866.30.DA
 - 09.2866.14.DA

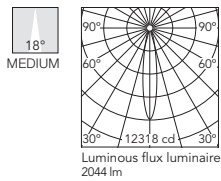

Beam Angle: 18°

h(m)	E(lx)	D(m)
1	12318	0.31
2	3080	0.62
3	1369	0.93
4	770	1.24
5	493	1.55

Solid Pure Ceiling

Light Source: LED Array 30W - 3667 lm - 4000K/CRI 80 / 35W - 4508 lm - 4000K/CRI 80

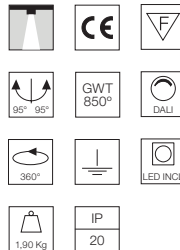
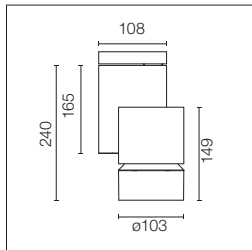

Decken- oder Strahler mit LED-Lampe. Netzgerät mit 220-240V, 50-60 Hz im Lieferumfang enthalten.

Spotlight to be installed on ceiling/wall with LED light source. 220-240V, 50-60Hz power supply included.

- 4000K - CRI 80**
30W - 3667 lm
Non Dimmable
- 09.2882.30
 - 09.2882.14
- Dali Version
- 09.2882.30.DA
 - 09.2882.14.DA

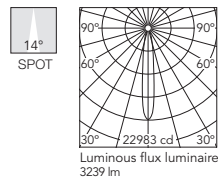

Beam Angle: 14°

h(m)	E(lx)	D(m)
1	22983	0.25
2	5746	0.51
3	2554	0.76
4	1436	1.01
5	919	1.27

- 4000K - CRI 80**
35W - 4508 lm
Non Dimmable
- 09.2962.30
 - 09.2962.14
- Dali Version
- 09.2962.30.DA
 - 09.2962.14.DA

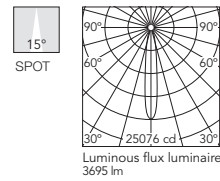

Beam Angle: 15°

h(m)	E(lx)	D(m)
1	25076	0.26
2	6269	0.53
3	2786	0.79
4	1567	1.05
5	1003	1.31

- 4000K - CRI 80**
30W - 3667 lm
Non Dimmable
- 09.2883.30
 - 09.2883.14
- Dali Version
- 09.2883.30.DA
 - 09.2883.14.DA

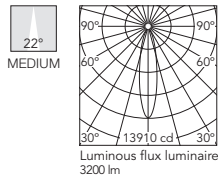

Beam Angle: 22°

h(m)	E(lx)	D(m)
1	13910	0.39
2	3478	0.79
3	1546	1.18
4	869	1.57
5	556	1.97

- 4000K - CRI 80**
35W - 4508 lm
Non Dimmable
- 09.2963.30
 - 09.2963.14
- Dali Version
- 09.2963.30.DA
 - 09.2963.14.DA

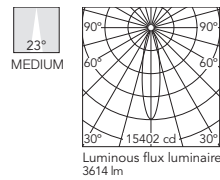

Beam Angle: 23°

h(m)	E(lx)	D(m)
1	15402	0.40
2	3850	0.80
3	1711	1.20
4	963	1.59
5	616	1.99

- 4000K - CRI 80**
30W - 3667 lm
Non Dimmable
- 09.2884.30
 - 09.2884.14
- Dali Version
- 09.2884.30.DA
 - 09.2884.14.DA

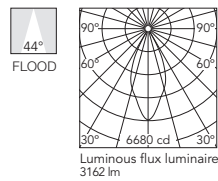

Beam Angle: 44°

h(m)	E(lx)	D(m)
1	6680	0.80
2	1670	1.61
3	742	2.41
4	418	3.22
5	267	4.02

- 4000K - CRI 80**
35W - 4508 lm
Non Dimmable
- 09.2964.30
 - 09.2964.14
- Dali Version
- 09.2964.30.DA
 - 09.2964.14.DA

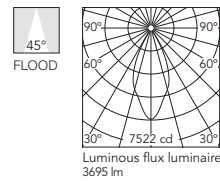

Beam Angle: 45°

h(m)	E(lx)	D(m)
1	7522	0.83
2	1880	1.65
3	836	2.48
4	470	3.31
5	301	4.13

SOLID PURE

Zubehör / Accessories

Sämtliches Zubehör ist stets mit dem Haltering zu verwenden. Dieser Haltering ermöglicht die Installation eines Blendschutzes vom Typ Wabenraster, eines Farbfilters oder von Blendschutz + Farbfilter.

All accessories should always be used with the holding ring. This holding ring allows to use the spotlight with a "honeycomb" anti-glare screen or a color filter or both, a "honeycomb" + a color filter.

Haltering
Holding Ring



08.8768.14

Honeycomb
Honeycomb



08.8763.14

Blauer filter
Blue filter



08.8766.64.OD

Hellblauer filter
Filtre bleu ciel



08.8766.65.OD

Amber filter
Amber filter



08.8766.66.OD

Roter filter
Red filter



08.8766.67.OD

PURE SPOT

DESIGNED BY KNUD HOLSCHER

PURE SPOT

PURE SPOT
PRO



LIGHT SOURCE
LED ARRAY
17,5W
2115 lm
3000K/CRI 80

LIGHT SOURCE
POWER LED
15,7W
1400 lm
2700K/CRI 80
3000K/CRI 80

LIGHT SOURCE
PHOSPHOR
LED
19,5W
2000 lm
3000K/CRI 80
17W
1400 lm
3000K/CRI 98

□ 30 Weiss
30 White

■ 02 Grau
02 Grey

■ 14 Schwarz
14 Black



Drehbar um 180° und schwenkbar 180°.
Can be rotated 180° and swivelled 180°.

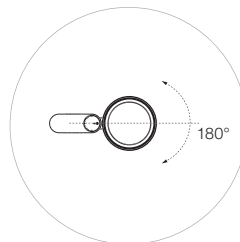
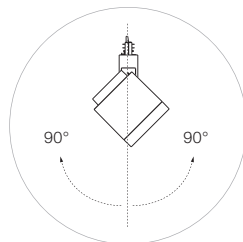

reddot design award
winner 2008

DESIGN PLUS

528

Produktbeschreibung

Direkt an der Decke oder auf Drei-Phasen-Stromschiene installierbarer Strahler.
Leuchtmittelhalterung aus Keramik oder selbstlöschendem Technopolymer, mit einpoliger, teflon-isolierter Zuleitung mit doppelter, transparenter Isolierung. Der Leuchtenkörper besteht aus einem lichtstreuenden Element aus Aluminium, das auf die Leuchtmittelhalterung aufgesetzt ist, aus einem Vorsatzhalterung aus schwarzem, thermoplastischen Material und einem 4mm starkem Hartglas. Leuchtenkörper, Schließkappe und ausrichtbare Leuchtenhalterung sind aus Aluminiumlegierungsdruckguss, weiss, grau oder schwarz pulverlackiert. 3Ph.-Adapter aus thermoplastischem Material.

Reflektoren

Alle Optiken sind aus hochglanzpoliertem Reinaluminium.
Rund symmetrisch strahlend für Spot (10°) oder Wide Flood (51°).

Betriebsgerät

Nicht verstellbares elektronisches Transformator Gleichstrom 220/240V - 50/60Hz.

Zubehör

- Elliptische Lichtstreuulinse aus 4mm starkem gehärtetem Glas.
- Honeycomb.
- Farbfilter.

Zusatzinformationen

Ausrichtbarkeit um 180° auf der Vertikalachse und um 180° auf der Horizontalachse. Mit horizontalem und vertikalem Arretiersystem.
Schutzgrad IP20.
Schutzklasse I.
Auf normal entflammaren Oberflächen einsetzbar.
Die FLOS Schienenleuchten wurden für 3-Phasen Standardschienen, die von FLOS empfohlen werden, entwickelt und umfassend getestet. Ihre Kompatibilität ist mit denen von Nordic Aluminium und Eutrac produzierten 3-Phasen-Schienen garantiert. Wenn Sie die Kompatibilität mit anderen Schienen überprüfen möchten, kontaktieren Sie bitte FLOS vor der Installation.

Qualitätszeichen

Das Gerät entspricht der europäischen technischen Norm EN60598-1 und den entsprechenden Zusatzregelungen, und ist mit dem ENEC-Zeichen für elektrische Sicherheit versehen.

Description

Luminaire for ceiling or three-phase electric track installation.
Self-extinguishing ceramic or engineering plastic lamp holders, with single-pole, transparent electric wires with double Teflon insulation. Aluminum body, placed above the lamp holder, black thermoplastic and 4mm tempered glass screen-support ring. Die-cast aluminum alloy body, cover and adjustable lamp support, powder-coated white, grey or black. Thermoplastic three-phase adapter.

Reflectors

All super pure aluminum with specular finish.
Circular rotosymmetrical from 10° spot to 51° wide flood.

Power Supply

Electronic transformer with non-adjustable constant current 220/240V 50/60Hz.

Accessories

- 4mm tempered glass elliptical distribution lens.
- Honeycomb.
- Chromatic filters.

Additional Information

0° - 180° vertical rotation, 0° - 180° horizontal rotation.
Horizontal and vertical locking system.
IP20 protection grade.
Insulation class I.
Suitable for installation on normally inflammable surfaces.
FLOS three-phase lighting track luminaires are designed and fully tested for tracks recommended by FLOS.
Compatibility is guaranteed with three-phase track produced by Nordic Aluminium and Eutrac. To verify compatibility with any other track, please contact FLOS before installation.

Standard Compliance and Quality Marks

EN60598-1 European Technical Standards and any subsequent additions.



Ceiling



Track

PURE SPOT

Pure Spot Track

Light Source: LED Array 17,5W - 2115 lm - 3000K/CRI 80

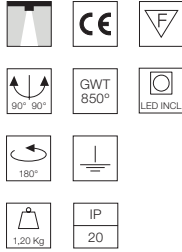
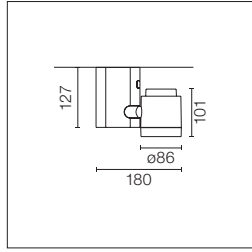

Strahler für 3-Phasen-Stromschiene mit LED-Lampe. Netzgerät mit 220/240V, 50/60Hz im Lieferumfang enthalten.

Spotlight to be installed on 3-phase track with LED light source. 220/240V, 50/60Hz power supply integrated.

- 09.2570.30A
- 09.2570.02A
- 09.2570.14A

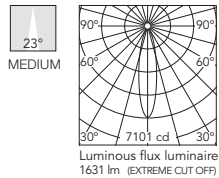

- 09.2571.30A
- 09.2571.02A
- 09.2571.14A

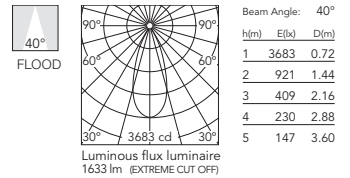

Pure Spot Ceiling

Light Source: LED Array 17,5W - 2115 lm - 3000K/CRI 80

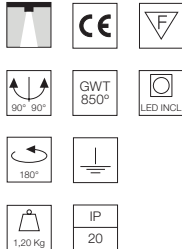
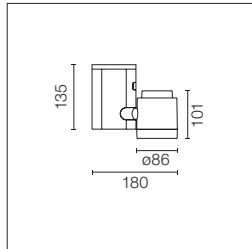

Decken- oder Wandstrahler mit LED-Lampe. Netzgerät mit 220/240V, 50/60Hz im Lieferumfang enthalten.

Spotlight to be installed on ceiling/wall with LED light source. 220/240V, 50/60Hz power supply integrated.

- 09.2575.30A
- 09.2575.02A
- 09.2575.14A

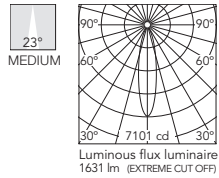

- 09.2576.30A
- 09.2576.02A
- 09.2576.14A

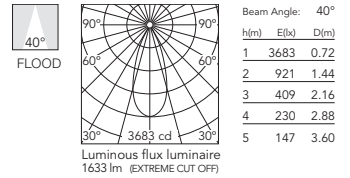

PURE SPOT

Pure Spot Track

Light Source: Phosphor LED 19,5W - 2000 lm - 3000K/CRI 80 / 17W - 1400 lm - 3000K/CRI 98

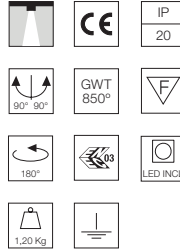
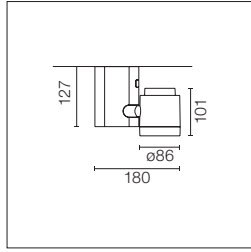

Strahler für 3-Phasen-Stromschiene mit LED-Lampe. Integrierter elektronischer Transformator 220/240V, 50/60Hz für integrierte LED mit Phosphorschicht.

Spotlight to be installed on 3-phase track with LED light source. Electronic transformer 220/240V, 50/60Hz for phosphor LED integrated. LED integrated.

- 3000K - CRI 80**
- ☐ 09.2410.30C
 - ▒ 09.2410.02C
 - 09.2410.14C

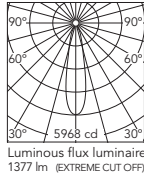

Beam Angle: 23°

h(m)	E(lx)	D(m)
1	5968	0.41
2	1492	0.81
3	663	1.22
4	373	1.62
5	239	2.03

- 3000K - CRI 98**
- ☐ 09.2400.30C
 - ▒ 09.2400.02C
 - 09.2400.14C

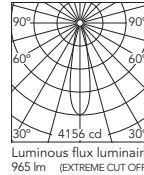

Beam Angle: 23°

h(m)	E(lx)	D(m)
1	4156	0.41
2	1039	0.81
3	462	1.22
4	260	1.63
5	166	2.04

- 3000K - CRI 80**
- ☐ 09.2411.30C
 - ▒ 09.2411.02C
 - 09.2411.14C

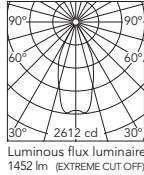

Beam Angle: 45°

h(m)	E(lx)	D(m)
1	2612	0.84
2	653	1.68
3	290	2.51
4	163	3.35
5	104	4.19

- 3000K - CRI 98**
- ☐ 09.2401.30C
 - ▒ 09.2401.02C
 - 09.2401.14C

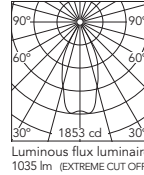

Beam Angle: 46°

h(m)	E(lx)	D(m)
1	1853	0.85
2	463	1.70
3	206	2.54
4	116	3.39
5	74	4.24

- 3000K - CRI 80**
- ☐ 09.2412.30C
 - ▒ 09.2412.02C
 - 09.2412.14C

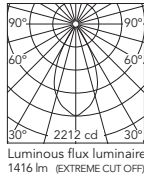

Beam Angle: 51°

h(m)	E(lx)	D(m)
1	2212	0.95
2	553	1.90
3	246	2.85
4	138	3.79
5	88	4.74

- 3000K - CRI 98**
- ☐ 09.2402.30C
 - ▒ 09.2402.02C
 - 09.2402.14C

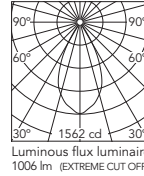

Beam Angle: 51°

h(m)	E(lx)	D(m)
1	1562	0.95
2	391	1.91
3	174	2.86
4	98	3.82
5	62	4.77

PURE SPOT

Pure Spot Ceiling

Light Source: Phosphor LED 19,5W - 2000 lm - 3000K/CRI 80 / 17W - 1400 lm - 3000K/CRI 98

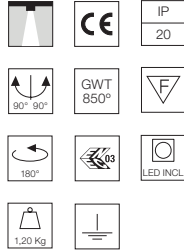
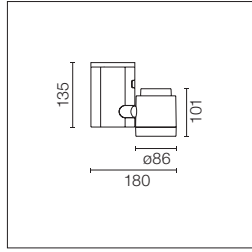

Decken- oder Wandstrahler mit LED-Lampe. Integrierter elektronischer Transformator 220/240V, 50/60Hz für integrierte LED mit Phosphorschicht.

Spotlight to be installed on ceiling/wall with LED light source. Electronic transformer 220/240V, 50/60Hz for phosphor LED integrated.

3000K - CRI 80
 09.2460.30C
 09.2460.02C
 09.2460.14C

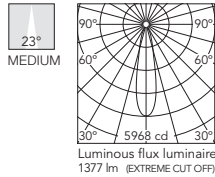

Beam Angle: 23°

h(m)	E(lx)	D(m)
1	5968	0.41
2	1492	0.81
3	663	1.22
4	373	1.62
5	239	2.03

3000K - CRI 98
 09.2450.30C
 09.2450.02C
 09.2450.14C

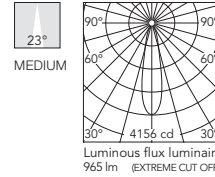

Beam Angle: 23°

h(m)	E(lx)	D(m)
1	4156	0.41
2	1039	0.81
3	462	1.22
4	260	1.63
5	166	2.04

3000K - CRI 80
 09.2461.30C
 09.2461.02C
 09.2461.14C

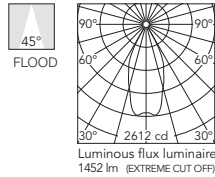

Beam Angle: 45°

h(m)	E(lx)	D(m)
1	2612	0.84
2	653	1.68
3	290	2.51
4	163	3.35
5	104	4.19

3000K - CRI 98
 09.2451.30C
 09.2451.02C
 09.2451.14C

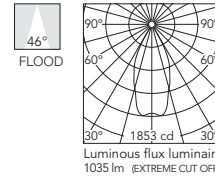

Beam Angle: 46°

h(m)	E(lx)	D(m)
1	1853	0.85
2	463	1.70
3	206	2.54
4	116	3.39
5	74	4.24

3000K - CRI 80
 09.2462.30C
 09.2462.02C
 09.2462.14C

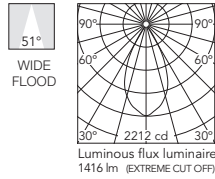

Beam Angle: 51°

h(m)	E(lx)	D(m)
1	2212	0.95
2	553	1.90
3	246	2.85
4	138	3.79
5	88	4.74

3000K - CRI 98
 09.2452.30C
 09.2452.02C
 09.2452.14C

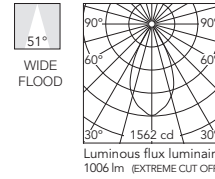

Beam Angle: 51°

h(m)	E(lx)	D(m)
1	1562	0.95
2	391	1.91
3	174	2.86
4	98	3.82
5	62	4.77

PURE SPOT

Pure Spot Track

Light Source: Power LED 15,7W - 1400 lm - 2700K/CRI 80 / 15,7W - 1400 lm - 3000K/CRI 80

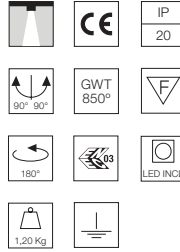
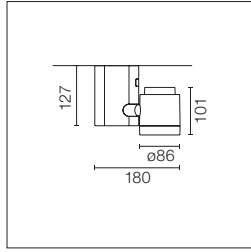

Strahler für 3-Phasen-Stromschiene mit LED-Lampe. Netzgerät mit 220/240V, 50/60Hz im Lieferumfang enthalten.

Spotlight to be installed on 3-phase track with LED light source. 220/240V, 50/60Hz power supply integrated.

2700K - CRI 80
 09.2405.30B
 09.2405.02B
 09.2405.14B

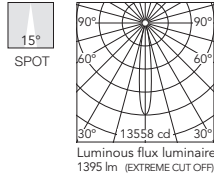

3000K - CRI 80
 09.2415.30B
 09.2415.02B
 09.2415.14B

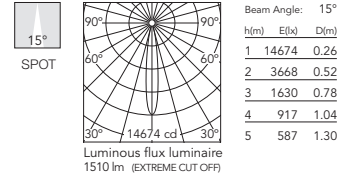

2700K - CRI 80
 09.2406.30B
 09.2406.02B
 09.2406.14B

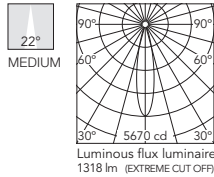

3000K - CRI 80
 09.2416.30B
 09.2416.02B
 09.2416.14B

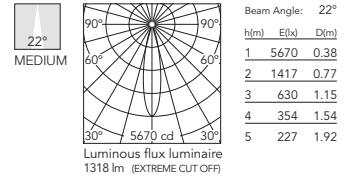

2700K - CRI 80
 09.2407.30B
 09.2407.02B
 09.2407.14B

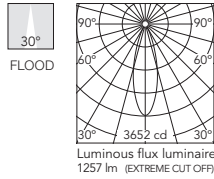

3000K - CRI 80
 09.2417.30B
 09.2417.02B
 09.2417.14B

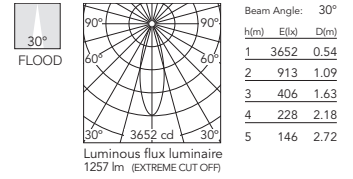

PURE SPOT

Pure Spot Ceiling

Light Source: Power LED 15,7W - 1400 lm - 2700K/CRI 80 / 15,7W - 1400 lm - 3000K/CRI 80

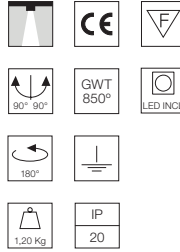
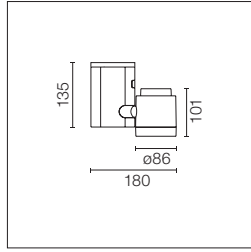

Decken- oder Wandstrahler mit LED-Lampe. Netzgerät mit 220/240V, 50/60Hz im Lieferumfang enthalten.

Spotlight to be installed on ceiling/wall with LED light source. 220/240V, 50/60Hz power supply integrated.

- 2700K - CRI 80**
- 09.2455.30B
 - 09.2455.02B
 - 09.2455.14B

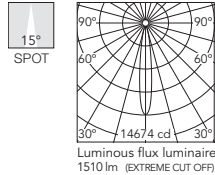

- 3000K - CRI 80**
- 09.2465.30B
 - 09.2465.02B
 - 09.2465.14B

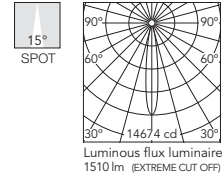

- 2700K - CRI 80**
- 09.2456.30B
 - 09.2456.02B
 - 09.2456.14B

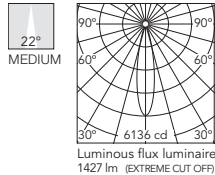

- 3000K - CRI 80**
- 09.2466.30B
 - 09.2466.02B
 - 09.2466.14B

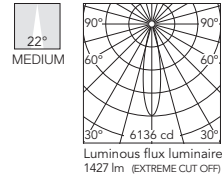

- 2700K - CRI 80**
- 09.2457.30B
 - 09.2457.02B
 - 09.2457.14B

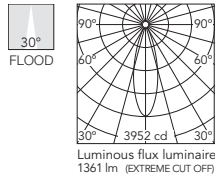

- 3000K - CRI 80**
- 09.2467.30B
 - 09.2467.02B
 - 09.2467.14B

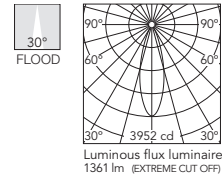

Pure Spot Pro Track

Light Source: LED Array 17,5W - 2115 lm - 3000K/CRI 80

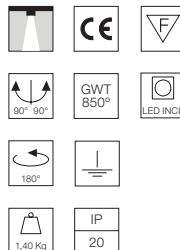
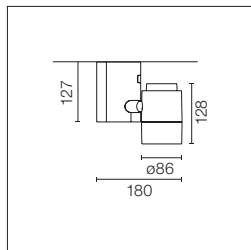

Strahler für 3-Phasen-Stromschiene mit LED-Lampe. Netzgerät mit 220/240V, 50/60Hz im Lieferumfang enthalten.

Spotlight to be installed on 3-phase track with LED light source. 220/240V, 50/60Hz power supply integrated.

- 09.2580.30A
■ 09.2580.02A
■ 09.2580.14A

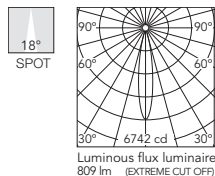

- 09.2581.30A
■ 09.2581.02A
■ 09.2581.14A

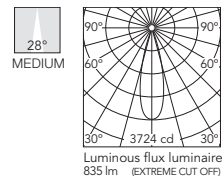

PURE SPOT

Pure Spot Pro Ceiling

Light Source: LED Array 17,5W - 2115 lm - 3000K/CRI 80

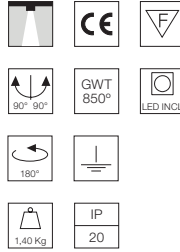
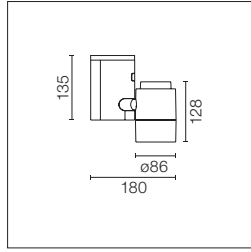

Decken- oder Wandstrahler mit LED-Lampe. Netzgerät mit 220/240V, 50/60Hz im Lieferumfang enthalten.

Spotlight to be installed on ceiling/wall with LED light source. 220/240V, 50/60Hz power supply integrated.

- 09.2585.30A
- 09.2585.02A
- 09.2585.14A

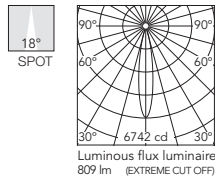

Beam Angle: 18°

h(m)	E(lx)	D(m)
1	6742	0.31
2	1685	0.62
3	749	0.94
4	421	1.25
5	270	1.56

- 09.2586.30A
- 09.2586.02A
- 09.2586.14A

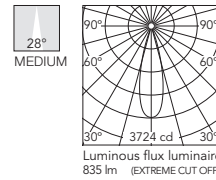

Beam Angle: 28°

h(m)	E(lx)	D(m)
1	3724	0.49
2	931	0.99
3	414	1.48
4	233	1.97
5	149	2.47

Pure Spot Pro Track

Light Source: Phosphor LED 19,5W - 2000 lm - 3000K/CRI 80 / 17W - 1400 lm - 3000K/CRI 98

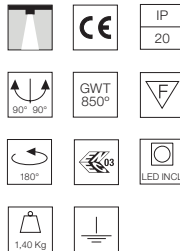
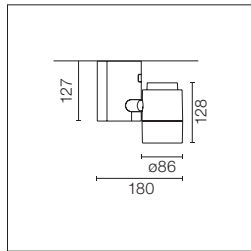

Strahler für 3-Phasen-Stromschiene mit LED-Lampe. Netzgerät mit 220-240V, 50-60Hz im Lieferumfang enthalten.

Spotlight to be installed on 3-phase track with LED light source. Electronic transformer 220/240V, 50/60Hz for phosphor LED integrated.

- 3000K - CRI 80**
- 09.2430.30C
 - 09.2430.02C
 - 09.2430.14C

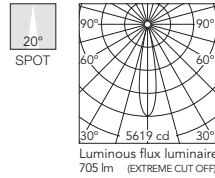

Beam Angle: 20°

h(m)	E(lx)	D(m)
1	5619	0.35
2	1405	0.69
3	624	1.04
4	351	1.38
5	225	1.73

- 3000K - CRI 98**
- 09.2420.30C
 - 09.2420.02C
 - 09.2420.14C

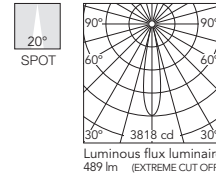

Beam Angle: 20°

h(m)	E(lx)	D(m)
1	3818	0.35
2	955	0.70
3	424	1.05
4	239	1.40
5	153	1.75

- 3000K - CRI 80**
- 09.2431.30C
 - 09.2431.02C
 - 09.2431.14C

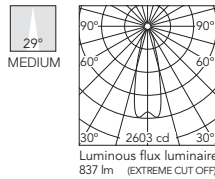

Beam Angle: 29°

h(m)	E(lx)	D(m)
1	2603	0.53
2	651	1.05
3	289	1.58
4	163	2.10
5	104	2.63

- 3000K - CRI 98**
- 09.2421.30C
 - 09.2421.02C
 - 09.2421.14C

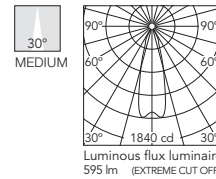

Beam Angle: 30°

h(m)	E(lx)	D(m)
1	1840	0.53
2	460	1.06
3	204	1.59
4	115	2.11
5	74	2.64

- 3000K - CRI 80**
- 09.2432.30C
 - 09.2432.02C
 - 09.2432.14C

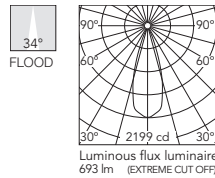

Beam Angle: 34°

h(m)	E(lx)	D(m)
1	2199	0.61
2	550	1.22
3	244	1.83
4	137	2.44
5	88	3.05

- 3000K - CRI 98**
- 09.2422.30C
 - 09.2422.02C
 - 09.2422.14C

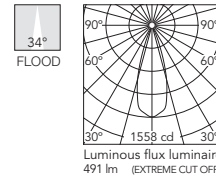

Beam Angle: 34°

h(m)	E(lx)	D(m)
1	1558	0.61
2	389	1.22
3	173	1.83
4	97	2.44
5	62	3.05

PURE SPOT

Pure Spot Pro Ceiling

Light Source: Phosphor LED 19,5W - 2000 lm - 3000K/CRI 80 / 17W - 1400 lm - 3000K/CRI 98

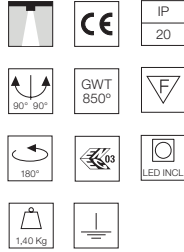
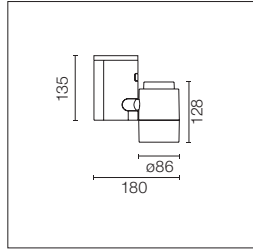

Decken- oder Wandstrahler mit LED-Lampe. Integrierter elektronischer Transformator 220/240V, 50/60Hz für integrierte LED mit Phosphorschicht. Spotlight to be installed on ceiling/wall with LED light source. Electronic transformer 220/240V, 50/60Hz for phosphor LED integrated.

- 3000K - CRI 80**
- 09.2480.30C
 - 09.2480.02C
 - 09.2480.14C

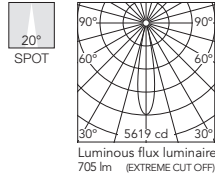

Beam Angle: 20°

h(m)	E(lx)	D(m)
1	5619	0.35
2	1405	0.69
3	624	1.04
4	351	1.38
5	225	1.73

- 3000K - CRI 98**
- 09.2470.30C
 - 09.2470.02C
 - 09.2470.14C

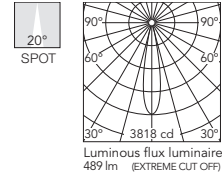

Beam Angle: 20°

h(m)	E(lx)	D(m)
1	3818	0.35
2	955	0.70
3	424	1.05
4	239	1.40
5	153	1.75

- 3000K - CRI 80**
- 09.2481.30C
 - 09.2481.02C
 - 09.2481.14C

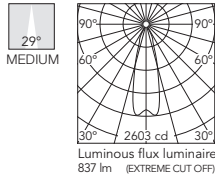

Beam Angle: 29°

h(m)	E(lx)	D(m)
1	2603	0.53
2	651	1.05
3	289	1.58
4	163	2.10
5	104	2.63

- 3000K - CRI 98**
- 09.2471.30C
 - 09.2471.02C
 - 09.2471.14C

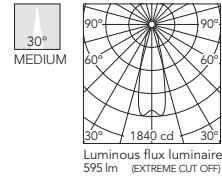

Beam Angle: 30°

h(m)	E(lx)	D(m)
1	1840	0.53
2	460	1.06
3	204	1.59
4	115	2.11
5	74	2.64

- 3000K - CRI 80**
- 09.2482.30C
 - 09.2482.02C
 - 09.2482.14C

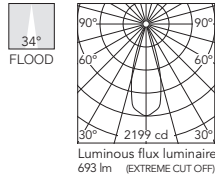

Beam Angle: 34°

h(m)	E(lx)	D(m)
1	2199	0.61
2	550	1.22
3	244	1.83
4	137	2.44
5	88	3.05

- 3000K - CRI 98**
- 09.2472.30C
 - 09.2472.02C
 - 09.2472.14C

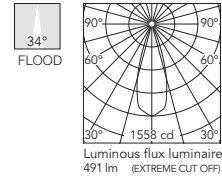

Beam Angle: 34°

h(m)	E(lx)	D(m)
1	1558	0.61
2	389	1.22
3	173	1.83
4	97	2.44
5	62	3.05

PURE SPOT

Pure Spot Pro Track

Light Source: Power LED 15,7W - 1400 lm - 2700K/CRI 80 / 15,7W - 1400 lm - 3000K/CRI 80

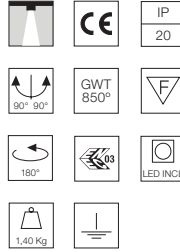
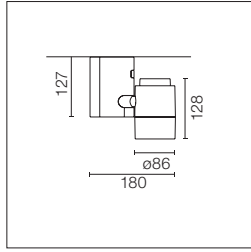

Strahler für 3-Phasen-Stromschiene mit LED-Lampe. Netzgerät mit 220/240V, 50/60Hz im Lieferumfang enthalten.

Spotlight to be installed on 3-phase track with LED light source. 220/240V, 50/60Hz power supply integrated.

2700K - CRI 80
 □ 09.2425.30B
 ■ 09.2425.02B
 ■ 09.2425.14B

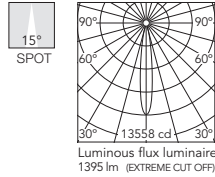

Beam Angle: 15°

h(m)	Ef(lx)	D(m)
1	13558	0.26
2	3390	0.52
3	1506	0.78
4	847	1.04
5	542	1.30

3000K - CRI 80
 □ 09.2435.30B
 ■ 09.2435.02B
 ■ 09.2435.14B

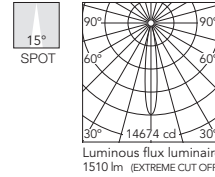

Beam Angle: 15°

h(m)	Ef(lx)	D(m)
1	14674	0.26
2	3668	0.52
3	1630	0.78
4	917	1.04
5	587	1.30

2700K - CRI 80
 □ 09.2426.30B
 ■ 09.2426.02B
 ■ 09.2426.14B

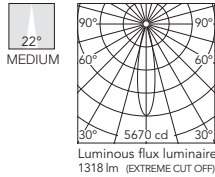

Beam Angle: 22°

h(m)	Ef(lx)	D(m)
1	5670	0.38
2	1417	0.77
3	630	1.15
4	354	1.54
5	227	1.92

3000K - CRI 80
 □ 09.2436.30B
 ■ 09.2436.02B
 ■ 09.2436.14B

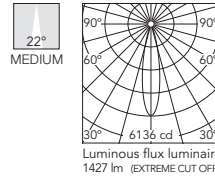

Beam Angle: 22°

h(m)	Ef(lx)	D(m)
1	6136	0.38
2	1534	0.77
3	682	1.15
4	384	1.54
5	245	1.92

2700K - CRI 80
 □ 09.2427.30B
 ■ 09.2427.02B
 ■ 09.2427.14B

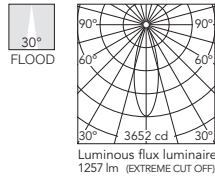

Beam Angle: 30°

h(m)	Ef(lx)	D(m)
1	3652	0.54
2	913	1.09
3	406	1.63
4	228	2.18
5	146	2.72

3000K - CRI 80
 □ 09.2437.30B
 ■ 09.2437.02B
 ■ 09.2437.14B

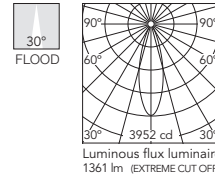

Beam Angle: 30°

h(m)	Ef(lx)	D(m)
1	3952	0.54
2	988	1.09
3	439	1.63
4	247	2.18
5	158	2.72

PURE SPOT

Pure Spot Pro Ceiling

Light Source: Power LED 15,7W - 1400 lm - 2700K/CRI 80 / 15,7W - 1400 lm - 3000K/CRI 80

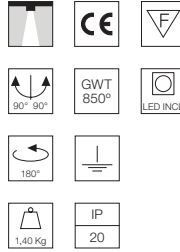
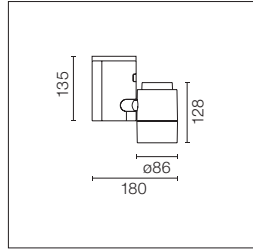

Decken- oder Wandstrahler mit LED-Lampe. Netzgerät mit 220/240V, 50/60Hz im Lieferumfang enthalten.

Spotlight to be installed on ceiling/wall with LED light source. 220/240V, 50/60Hz power supply integrated.

2700K - CRI 80
 □ 09.2475.30B
 ■ 09.2475.02B
 ■ 09.2475.14B

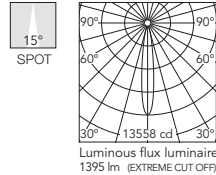

Beam Angle: 15°

h(m)	E(lx)	D(m)
1	13558	0.26
2	3390	0.52
3	1506	0.78
4	847	1.04
5	542	1.30

3000K - CRI 80
 □ 09.2485.30B
 ■ 09.2485.02B
 ■ 09.2485.14B

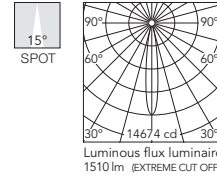

Beam Angle: 15°

h(m)	E(lx)	D(m)
1	14674	0.26
2	3668	0.52
3	1630	0.78
4	917	1.04
5	587	1.30

2700K - CRI 80
 □ 09.2476.30B
 ■ 09.2476.02B
 ■ 09.2476.14B

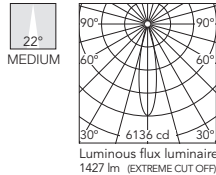

Beam Angle: 22°

h(m)	E(lx)	D(m)
1	6136	0.38
2	1534	0.77
3	682	1.15
4	384	1.54
5	245	1.92

3000K - CRI 80
 □ 09.2486.30B
 ■ 09.2486.02B
 ■ 09.2486.14B

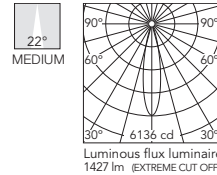

Beam Angle: 22°

h(m)	E(lx)	D(m)
1	6136	0.38
2	1534	0.77
3	682	1.15
4	384	1.54
5	245	1.92

2700K - CRI 80
 □ 09.2477.30B
 ■ 09.2477.02B
 ■ 09.2477.14B

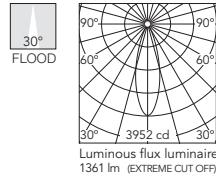

Beam Angle: 30°

h(m)	E(lx)	D(m)
1	3952	0.54
2	988	1.09
3	439	1.63
4	247	2.18
5	158	2.72

3000K - CRI 80
 □ 09.2487.30B
 ■ 09.2487.02B
 ■ 09.2487.14B

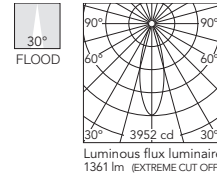

Beam Angle: 30°

h(m)	E(lx)	D(m)
1	3952	0.54
2	988	1.09
3	439	1.63
4	247	2.18
5	158	2.72

PURE SPOT

Zubehör / Accessories

Pure Spot

Die elliptischen Linsen, der Abblendrastrer und die verschiedenen Filter müssen immer mit dem Haltering verwendet werden.

Elliptical lens, honeycomb filter, different filters and flood lens, must always be used with the holding ring.

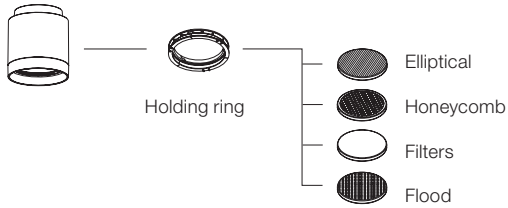

Haltering
Holding ring 08.8166.14

Honeycomb
Honeycomb 08.8169.14

Pure Spot Pro

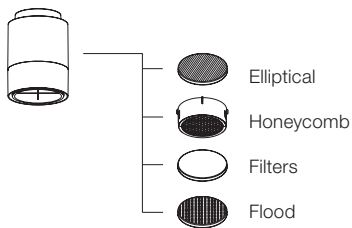

Honeycomb
Honeycomb 08.8186.14

Pure Spot / Pure Spot Pro

Elliptische linse
Elliptical lens 08.8163.68

Floodlinse
Flood lens 08.8175.68

Blauer filter
Blue filter 08.8160.64.OD

Hellblauer filter
Sky blue filter 08.8160.65.OD

Amber filter
Amber filter 08.8160.66.OD

Roter filter
Red filter 08.8160.67.OD

U.V. filter
U.V. filter 08.8160.98.OD

I.R. filter
I.R. filter 08.8160.68

Hot light
Hot light 08.8160.69

Cold light
Cold light 08.8160.CL

Daylight
Daylight 08.8160.DL

Neodimium
Neodimium 08.8160.ND

Außenring PRO für Pure Spot.
Nur für halogenlampen. Version
LED auf anfrage. 08.8232.30
08.8232.02
08.8232.14

Pure Spot external ring
accessory PRO. Only for
halogen lamps. Consult for LED
version.

WAN SPOT

DESIGNED BY JOHANNA GRAWUNDER



LIGHT SOURCE
LED ARRAY
9,2W
945 lm
3000K/CRI 80



LIGHT SOURCE
LED
QT-14
G9

□ 30 Weiss
30 White

◻ 05 Hochglänzendes
Aluminium
05 Polished Aluminium

■ 14 Schwarz
14 Black

■ GN Grün
GN Green



Drehbar um 360° und schwenkbar 60°.
Can be rotated 360° and swivelled 60°.

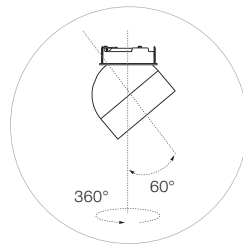

Produktbeschreibung

Wand- oder Deckenleuchte für direktes Licht. Leuchtenkörper aus Aluminium in folgenden Ausführungen: Verchromt, glänzend weiß, glänzend grün und glänzend schwarz. Blendschutzschirm. Die Leuchte verfügt über zwei verschiedene Schließringe, glänzend grün und glänzend schwarz, zur Befestigung des gehärteten Sicherheitsglases.

Reflektoren

Sandgestrahler, chemisch gebleichter Reflektor.

Betriebsgerät

Vorverkabelung zum Anschluss eines externen Betriebsgeräts inbegriffen.

Zusatzinformationen

Drehbar bis zu 360° um die Vertikalachse und schwenkbar bis 60°. Schutzgrad IP20. Schutzklasse II, III je nach Modell. Auf normal entflammaren Oberflächen einsetzbar.

Qualitätszeichen

Das Gerät entspricht der europäischen technischen Norm EN60598-1 und den entsprechenden Zusatzregelungen.

Description

Wall or ceiling lamp providing direct light. Aluminum body, available in chrome, shiny white, enameled green, and shiny black finishes. Low glare shield. Provided by two different ring due to fix the safety tempered glass, in shiny black and enameled green.

Reflectors

Sanded and chemically bleached aluminum reflector.

Power Supply

Pre-wiring included; ready for remote power supply.

Additional Information

0° - 360° vertical rotation and 0° - 60° adjustment. IP20 protection grade. Insulation class II, III depending on the versions. Suitable for installation on normally inflammable surfaces.

Standard Compliance and Quality Marks

EN60598-1 European Technical Standards and any subsequent additions.

WAN SPOT

Wan Spot

Light Source: LED Array DC 500 mA - 9,2W - 945 lm - 3000K/CRI 80

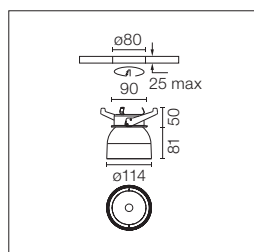

Decken/Wand-Einbaustrahler. Ohne Netzgerät. Spotlight to be installed recessed on ceiling/wall. Power supply not included.

Empfohlene Netzgeräte / Recommended power supply*:
 Non Dimmable 60.9160
 Dimmable 1-10V 60.9188
 Dimmable Dali 60.8847
 Dimmable Dali 2 60.9222
 Mains Dimming 60.9411
 Casambi 60.9207

* Siehe Treiberkapitel / Refer to the Drivers chapter

- 03.6174.30A
- 03.6174.05A
- 03.6174.14A
- 03.6174.GNA

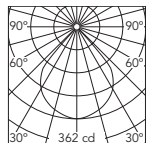

Beam Angle: 82°

h(m)	E(lx)	D(m)
1	362	1.75
2	91	3.50
3	40	5.25
4	23	7.00
5	14	8.75

Luminous flux luminaire 505 lm

Wan Spot

Light Source: LED QT-14 G9

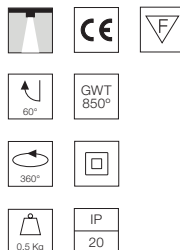
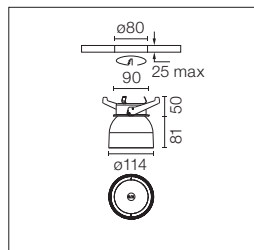

Decken/Wand-Einbaustrahler mit Netzspannungsversorgung. Spotlight to be installed recessed on ceiling/wall with main voltage source.

- 03.6170.30
- 03.6170.05
- 03.6170.14
- 03.6170.GN

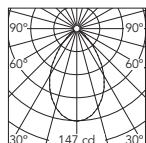

Beam Angle: 68°

h(m)	E(lx)	D(m)
1	147	1.35
2	37	2.70
3	16	4.05
4	9	5.40
5	6	6.75

Luminous flux luminaire 460 lm

@Black Ring

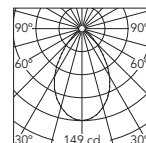

Beam Angle: 69°

h(m)	E(lx)	D(m)
1	149	1.38
2	37	2.75
3	17	4.13
4	9	5.50
5	6	6.88

Luminous flux luminaire 460 lm

@Green Ring

FORT KNOX

DESIGNED BY PHILIPPE STARCK

TRACK /
CEILING



LIGHT SOURCE

LED ARRAY
9,2W
945 lm
3000K/CRI 80
13,8W
1474 lm
3000K/CRI 80

□ 30 Weiss/RAL 9001
30 White



◻ 05 Hochglänzendes Aluminium
05 Polished Aluminium



■ 14 Schwarz/RAL 9005
14 Black



Drehbar um 355° und schwenkbar 95°.
Can be rotated 355° and swivelled 95°.

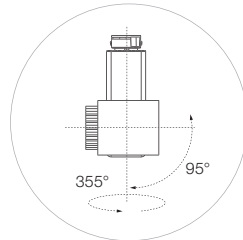

Produktbeschreibung

Direkt an der Decke oder auf Drei-Phasen-Stromschiene installierbarer Strahler.
Leuchtmittelhalterung aus Keramik oder selbstlöschendem Technopolymer, mit einpoligen teflon-isolierten Elektrokabeln mit doppelter, transparenter Isolierung. Der Leuchtenkörper besteht aus einem lichtstreuenden Element aus Aluminium, das auf die Leuchtmittelhalterung aufgesetzt ist, aus einem Vorsatzhalterring aus schwarzem, thermoplastischen Material und einem 4mm starkem Hartglas. Leuchtenkörper, Schließkappe und ausrichtbare Leuchtenhalterung sind aus Aluminiumlegierungsdruckguss, in handpolierter Ausführung mit transparentem, flüssigem Schutzlack oder weiß oder mattschwarz pulverlackiert. Dreiphasen Adapter aus thermoplastischem Material.

Betriebsgerät

Betriebsgeräte im Hauptkörper der Leuchte.
Für die Installation auf einer Drei-Phasen-Stromschiene verfügt die Leuchte über ein rundes, nach rechts und links drehbares Verbindungselement, mit dem die Leitung gewählt werden kann, an die der Strahler anzuschließen ist.
Entriegelungshebel zum Einsetzen des Adapters.

Zubehör

- Elliptische Lichtstreuulinse aus 4 mm starkem gehärtetem Glas.
- Farbfilter.

Zusatzinformationen

Drehbar um 355° auf der Vertikalachse, schwenkbar um +/- 95° auf der Horizontalachse.
Schutzgrad IP20.
Schutzklasse I, II je nach Modell.
Auf normal entflammaren Oberflächen einsetzbar.
Die FLOS Schienenleuchten wurden für 3-Phasen Standardschienen, die von FLOS empfohlen werden, entwickelt und umfassend getestet. Ihre Kompatibilität ist mit denen von Nordic Aluminium und Eutrac produzierten 3-Phasen-Schienen garantiert. Wenn Sie die Kompatibilität mit anderen Schienen überprüfen möchten, kontaktieren Sie bitte FLOS vor der Installation.

Qualitätszeichen

Das Gerät entspricht der europäischen technischen Norm EN60598-1 und den entsprechenden Zusatzregelungen.

Description

Luminaire for ceiling or three-phase electric track installation.
Self-extinguishing ceramic or engineering plastic lamp holders, with single-pole, transparent electric wires with double Teflon insulation. Aluminum body, placed above the lamp holder, black thermoplastic and 4mm tempered glass screen-support ring. Die-cast aluminum alloy body, cover and adjustable lamp support, with hand-polished finish and protected with transparent liquid paint, or powder-coated white or matt black. Thermoplastic three-phase adapter.

Power Supply

Power units built into the main body of the luminaire.
For three-phase track applications, disc with clockwise and anti-clockwise rotation for spotlight selection.
Release lever to insert adapter.

Accessories

- 4 mm tempered glass elliptical distribution lens.
- Chromatic filters.

Additional Information

0° - 355° vertical rotation, + 0° - 95° horizontal adjustment.
IP20 protection grade.
Insulation class I, III depending on the versions.
Suitable for installation on normally inflammable surfaces.
FLOS three-phase lighting track luminaires are designed and fully tested for tracks recommended by FLOS.
Compatibility is guaranteed with three-phase track produced by Nordic Aluminium and Eutrac. To verify compatibility with any other track, please contact FLOS before installation.

Standard Compliance and Quality Marks

EN60598-1 European Technical Standards and any subsequent additions.



Ceiling



Track

FORT KNOX

Fort Knox Track

Light Source: LED Array 9,2W - 945 lm - 3000K/CRI 80 / 13,8W - 1474 lm - 3000K/CRI 80

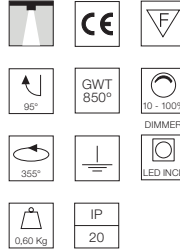
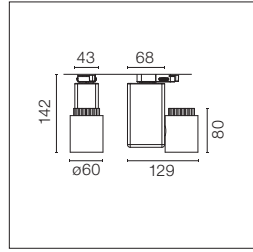

Strahler für 3-Phasen-Stromschiene mit LED-Lampe. Netzgerät mit 220-240V, 50-60Hz im Lieferumfang enthalten.

Spotlight to be installed on 3-phase track with LED light source. 220-240V, 50-60Hz power supply included.

3000K - CRI 80

9,2W

Non Dimmable

- 09.2150.30A
- 09.2150.05A
- 09.2150.14A

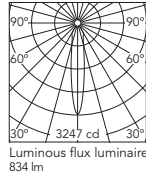

Beam Angle: 17°

h(m)	Ef(lx)	D(m)
1	3247	0.30
2	812	0.59
3	361	0.89
4	203	1.19
5	130	1.49

3000K - CRI 80

13,8W

Built-In Potentiometer

- 09.2160.30A
- 09.2160.05A
- 09.2160.14A

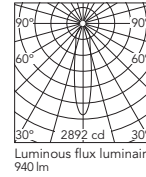

Beam Angle: 22°

h(m)	Ef(lx)	D(m)
1	2892	0.38
2	723	0.76
3	322	1.14
4	180	1.53
5	116	1.91

3000K - CRI 80

9,2W

Non Dimmable

- 09.2151.30A
- 09.2151.05A
- 09.2151.14A

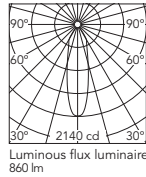

Beam Angle: 27°

h(m)	Ef(lx)	D(m)
1	2140	0.48
2	535	0.97
3	238	1.45
4	134	1.94
5	86	2.42

3000K - CRI 80

13,8W

Built-In Potentiometer

- 09.2161.30A
- 09.2161.05A
- 09.2161.14A

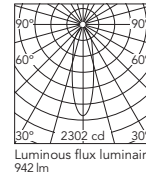

Beam Angle: 27°

h(m)	Ef(lx)	D(m)
1	2302	0.49
2	575	0.98
3	256	1.47
4	144	1.95
5	92	2.44

3000K - CRI 80

9,2W

Non Dimmable

- 09.2152.30A
- 09.2152.05A
- 09.2152.14A

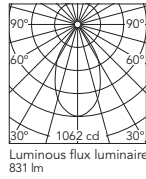

Beam Angle: 57°

h(m)	Ef(lx)	D(m)
1	1062	1.08
2	266	2.16
3	118	3.24
4	66	4.32
5	42	5.40

3000K - CRI 80

13,8W

Built-In Potentiometer

- 09.2162.30A
- 09.2162.05A
- 09.2162.14A

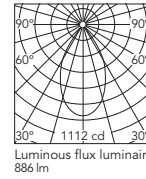

Beam Angle: 57°

h(m)	Ef(lx)	D(m)
1	1112	1.09
2	278	2.18
3	124	3.27
4	69	4.36
5	44	5.45

FORT KNOX

Fort Knox Ceiling

Light Source: LED Array 9,2W - 945 lm - 3000K/CRI 80 / 13,8W - 1474 lm - 3000K/CRI 80

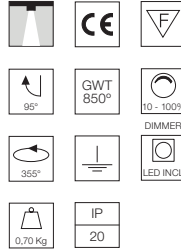
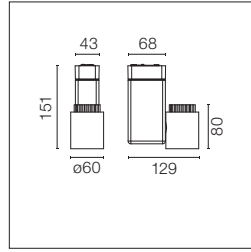

Decken- oder Wandstrahler mit LED-Lampe. Netzgerät mit 220-240V, 50-60Hz im Lieferumfang enthalten.

Spotlight to be installed on ceiling/wall with LED light source. 220-240V, 50-60Hz power supply included.

3000K - CRI 80

9,2W

Non Dimmable

09.2155.30A

09.2155.05A

09.2155.14A

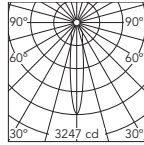

Beam Angle: 17°	h(m)	E(lx)	D(m)
1	3247	0.30	
2	812	0.59	
3	361	0.89	
4	203	1.19	
5	130	1.49	

Luminous flux luminaire 834 lm

3000K - CRI 80

13,8W

Built-In Potentiometer

09.2165.30A

09.2165.05A

09.2165.14A

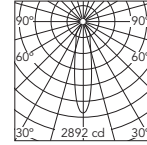

Beam Angle: 22°	h(m)	E(lx)	D(m)
1	2892	0.38	
2	723	0.76	
3	322	1.14	
4	180	1.53	
5	116	1.91	

Luminous flux luminaire 940 lm

3000K - CRI 80

9,2W

Non Dimmable

09.2156.30A

09.2156.05A

09.2156.14A

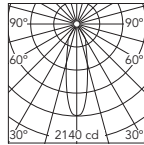

Beam Angle: 27°	h(m)	E(lx)	D(m)
1	2140	0.48	
2	535	0.97	
3	238	1.45	
4	134	1.94	
5	86	2.42	

Luminous flux luminaire 860 lm

3000K - CRI 80

13,8W

Built-In Potentiometer

09.2166.30A

09.2166.05A

09.2166.14A

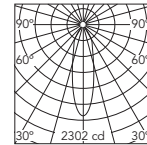

Beam Angle: 27°	h(m)	E(lx)	D(m)
1	2302	0.49	
2	575	0.98	
3	256	1.47	
4	144	1.95	
5	92	2.44	

Luminous flux luminaire 942 lm

3000K - CRI 80

9,2W

Non Dimmable

09.2157.30A

09.2157.05A

09.2157.14A

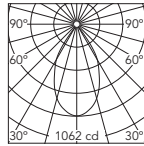

Beam Angle: 57°	h(m)	E(lx)	D(m)
1	1062	1.08	
2	266	2.16	
3	118	3.24	
4	66	4.32	
5	42	5.40	

Luminous flux luminaire 831 lm

3000K - CRI 80

13,8W

Built-In Potentiometer

09.2167.30A

09.2167.05A

09.2167.14A

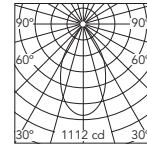

Beam Angle: 57°	h(m)	E(lx)	D(m)
1	1112	1.09	
2	278	2.18	
3	124	3.27	
4	69	4.36	
5	44	5.45	

Luminous flux luminaire 886 lm

Zubehör / Accessories

Honeycomb
Honeycomb



08.8502.14

Blauer filter
Blue filter



08.8501.64.OD

Hellblauer filter
Sky blue filter



08.8501.65.OD

Amber filter
Amber filter



08.8501.66.OD

Roter filter
Red filter



08.8501.67.OD

Hot light
Hot light



08.8501.69

Cold light
Cold light



08.8501.CL

Daylight
Daylight



08.8501.DL

Neodimium
Neodimium



08.8501.ND

CEILING / WALL

C1, UT Pro Surface, Kap Surface &
Suspension, Compass Box, Super Line & Pro,
Super Flat, Light Bell, Fort Knox
Wall & Mini, Thin LED, Wall System, G-O,
The Block of Light.

MONO SPOT
CEILING SMALL

LIGHT SOURCE
POWER LED
6W
510 lm
2700K/CRI 90
560 lm
3000K/CRI 90

MONO SPOT
WALL SMALL

LIGHT SOURCE
POWER LED
6W
510 lm
2700K/CRI 90
560 lm
3000K/CRI 90

DOUBLE SPOT
WALL SMALL

LIGHT SOURCE
POWER LED
12W
1020 lm
2700K/CRI 90
1120 lm
3000K/CRI 90

MONO SPOT
CEILING LARGE

LIGHT SOURCE
POWER LED
Up to 14W
1225 lm
2700K/CRI 90
1300 lm
3000K/CRI 90

MONO SPOT
WALL LARGE

LIGHT SOURCE
POWER LED
Up to 14W
1225 lm
2700K/CRI 90
1300 lm
3000K/CRI 90

DOUBLE SPOT
WALL LARGE

LIGHT SOURCE
POWER LED
Up to 28W
2450 lm
2700K/CRI 90
2600 lm
3000K/CRI 90

□ DY Weiss
DY White

■ DR Anthrazit
DR Anthracite

■ EQ Gebürstetes Kupfer
EQ Brushed Copper

■ ER Gebürsteter Stahl
ER Brushed Steel

■ ES Gebürstete Bronze
ES Brushed Bronze



Drehbar um 180° und schwenkbar 60°.
Can be rotated 180° and swivelled 60°.

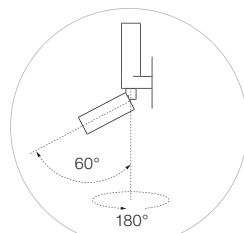

Wall

Drehbar um 355° und schwenkbar 60°.
Can be rotated 355° and swivelled 60°.

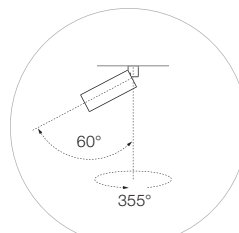

Ceiling

Produktbeschreibung

Neue Reihe von Wand- und Deckenleuchten, die für Anwendungen im Wohn- und Gaststättengewerbe entwickelt wurden.

Das extrem minimalistische Design des Produkts verbirgt eine spezielle integrierte mechanische Verbindung, die es ermöglicht, den Leuchtenkörper herauszuziehen und um bis zu 60° auf der vertikalen und horizontalen Achse auszurichten (355° für die Deckenversion und 140° für die Wandversion), was eine beeindruckende Vielseitigkeit garantiert, die perfekt auf die Anforderungen jedes Projekts abgestimmt ist.

Die für die Wandmontage entwickelten Versionen sind mit einfacher oder doppelter Emission erhältlich.

Optische Gruppe

Optische Gruppe mit hohem Sehkomfort im Gehäuse des Produkts, erhältlich mit differenzierten Strahlöffnungen.

Die Leuchte ist für eine diffuse Lichtemission oder eine konzentriertere Verteilung vorbereitet, perfekt für Akzentbeleuchtung oder Punktbeleuchtung zum Lesen im Kopfteil von Betten.

Die Modelle mit doppelter Emission enthalten als Zubehör einen Diffusorschirm, der in die optische Gruppe integriert werden kann, wodurch ein weicher Lichteffekt entsteht.

Betriebsgerät

Alle Leuchten müssen über eine nicht enthaltene Fernbedienung mit Strom versorgt werden, die mit verschiedenen Steuerungsalternativen erhältlich ist.

Regulierungssystem

Die Leuchten können mit 0/1-10V, DALI, Push Dimming und Casambi betrieben werden. Broadcast-Steuerungssystem. Bei den Geräten mit Doppelmmission können die direkten und indirekten Emissionen unabhängig voneinander eingestellt werden.

Installation

Das Produkt ist bereit für die Installation auf verschiedenen Arten von Oberflächen.

Alle Produkte werden mit einem speziellen Montagesatz für die No Trim-Installation oder mit einer Platte ergänzt. Die No Trim-Installation ist nur mit Gipskartonoberflächen mit einer Mindestdicke von 9 mm und einer maximalen Dicke von 25 mm möglich.

Die Platteninstallation ermöglicht die elektrische Verbindung innerhalb des Oberflächenträgers.

Zusatzinformationen

Konstantspannungsgesteuertes elektrisches System. IP20 Schutz-Index. Geeignet für die Installation auf normal entflammaren Oberflächen.

Qualitätszeichen

Das Gerät entspricht der europäischen technischen Norm EN60598-1 und den entsprechenden Zusatzregelungen.

Description

New program of wall and ceiling-mounted luminaires developed for residential and hospitality use.

The extremely minimalist design of the product hides a special, integrated mechanical connection that allows the luminaire body to be extracted and oriented up to 60° on the vertical axis and on the horizontal axis (355° in the ceiling version and 140° in the wall version), ensuring an impressive versatility, ideal to meet the needs of any project.

Versions developed for wall mounting are available with single or dual emission.

Optical Group

Optical group with high visual comfort in the body of the product, available with differentiated beamwidths.

This luminaire is designed to provide diffuse light emission or a more concentrated light distribution, ideal when accent or spot lighting is needed for reading in bed headboard applications.

Dual-emission models include a diffusing screen as accessory that can be integrated into the optical unit, producing a soft light effect.

Power Supply

All devices must be powered by a remote controller (not included) available with various control options.

Control System

Units can be controlled by 0/1-10V, DALI, Push Dimming and Casambi. Broadcast control system. In devices with dual emission, direct and indirect emissions can be controlled independently.

Installation

The product is ready to be installed on different surface types.

All products are completed with a dedicated No Trim or plate installation mounting kit. The No Trim installation is only compatible with plasterboard surfaces with a minimum thickness of 9mm and a maximum of 25mm. Plate installation allows the electrical connection to be made inside the surface mount.

Additional Information

Constant voltage controlled electrical system.

IP20 Protection Index.

Suitable for installation on normally flammable surfaces.

Standard Compliance and Quality Marks

EN60598-1 European Technical Standards and any subsequent additions.

Mono Spot Ceiling Small Ø35

Light Source: Power LED DC 500 mA - 6W - 510 lm - 2700K/CRI 90 / 6W - 560 lm - 3000K/CRI 90

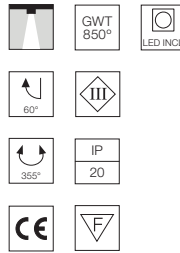
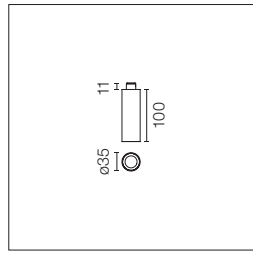

Verstellbare LED-Leuchte für den Innenbereich, geeignet für Deckenmontagen. Das Gehäuse kann aus der Installationsfläche herausgezogen werden, so dass eine Ausrichtung von 60° vertikal und 355° horizontal möglich ist. Integrierte Full-Cut-Off optische Gruppe. Die Fernspeisung (nicht enthalten) muss an einer zugänglichen Stelle angebracht werden. Der Installationsrahmen muss separat bestellt.

Adjustable luminaire with LED for indoor use, suitable for ceiling installation. The body can be extracted from the installation surface for 60° orientation on the vertical axis and 355° on the horizontal axis. Integrated Full cut-off optical group. The remote power supply (not included) must be placed in an accessible location. The installation frame must be ordered separately.

Empfohlene Netzgeräte / Recommended power supply*:

Non Dimmable	60.9592
Dimmable 1-10V	60.9208
Dimmable DALI 2 / Push	60.9186
Casambi	60.9207

* Siehe Treiberkapitel / Refer to the Drivers chapter

- 2700K**
- 03.1220.DY
 - 03.1220.DR
 - 03.1220.EQ
 - 03.1220.ER
 - 03.1220.ES

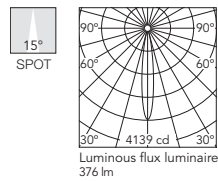

Beam Angle: 15°

h(m)	E(lx)	D(m)
1	4139	0.26
2	1035	0.51
3	460	0.77
4	259	1.03
5	166	1.28

Luminous flux luminaire 376 lm

- 3000K**
- 03.1225.DY
 - 03.1225.DR
 - 03.1225.EQ
 - 03.1225.ER
 - 03.1225.ES

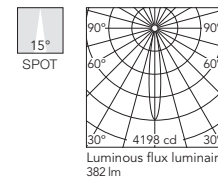

Beam Angle: 15°

h(m)	E(lx)	D(m)
1	4198	0.26
2	1050	0.51
3	466	0.77
4	262	1.03
5	168	1.28

Luminous flux luminaire 382 lm

- 2700K**
- 03.1221.DY
 - 03.1221.DR
 - 03.1221.EQ
 - 03.1221.ER
 - 03.1221.ES

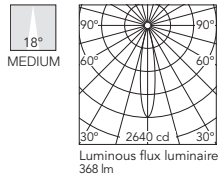

Beam Angle: 18°

h(m)	E(lx)	D(m)
1	2640	0.32
2	660	0.65
3	293	0.97
4	165	1.30
5	106	1.62

Luminous flux luminaire 368 lm

- 3000K**
- 03.1226.DY
 - 03.1226.DR
 - 03.1226.EQ
 - 03.1226.ER
 - 03.1226.ES

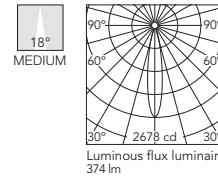

Beam Angle: 18°

h(m)	E(lx)	D(m)
1	2678	0.32
2	669	0.65
3	298	0.97
4	167	1.30
5	107	1.62

Luminous flux luminaire 374 lm

Mono Spot Wall Small Ø35

Light Source: Power LED DC 500 mA - 6W - 510 lm - 2700K/CRI 90 / 6W - 560 lm - 3000K/CRI 90

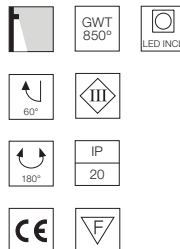
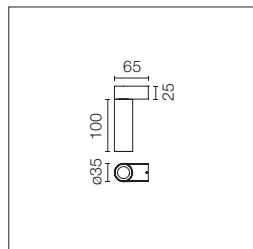

Verstellbare LED-Leuchte für den Innenbereich, geeignet für Wandmontagen. Das Gehäuse kann aus der Installationsfläche herausgezogen werden, so dass eine Ausrichtung von 60° vertikal und 180° horizontal möglich ist. Integrierte Full-Cut-Off optische Gruppe. Die Fernspeisung (nicht enthalten) muss an einer zugänglichen Stelle angebracht werden. Der Installationsrahmen muss separat bestellt.

Adjustable luminaire with LED for indoor use, suitable for wall installation. The body can be extracted from the installation surface for 60° orientation on the vertical axis and 180° on the horizontal axis. Integrated Full cut-off optical group. The remote power supply (not included) must be placed in an accessible location. The installation frame must be ordered separately.

Empfohlene Netzgeräte / Recommended power supply*:

Non Dimmable	60.9592
Dimmable 1-10V	60.9208
Dimmable DALI 2 / Push	60.9186
Casambi	60.9207

* Siehe Treiberkapitel / Refer to the Drivers chapter

- 2700K**
- 03.1200.DY
 - 03.1200.DR
 - 03.1200.EQ
 - 03.1200.ER
 - 03.1200.ES

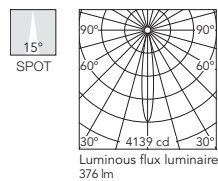

Beam Angle: 15°

h(m)	E(lx)	D(m)
1	4139	0.26
2	1035	0.51
3	460	0.77
4	259	1.03
5	166	1.28

Luminous flux luminaire 376 lm

- 3000K**
- 03.1205.DY
 - 03.1205.DR
 - 03.1205.EQ
 - 03.1205.ER
 - 03.1205.ES

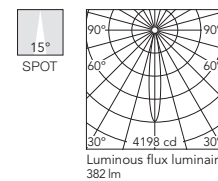

Beam Angle: 15°

h(m)	E(lx)	D(m)
1	4198	0.26
2	1050	0.51
3	466	0.77
4	262	1.03
5	168	1.28

Luminous flux luminaire 382 lm

- 2700K**
- 03.1201.DY
 - 03.1201.DR
 - 03.1201.EQ
 - 03.1201.ER
 - 03.1201.ES

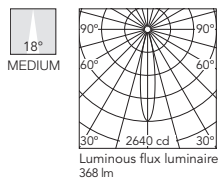

Beam Angle: 18°

h(m)	E(lx)	D(m)
1	2640	0.32
2	660	0.65
3	293	0.97
4	165	1.30
5	106	1.62

Luminous flux luminaire 368 lm

- 3000K**
- 03.1206.DY
 - 03.1206.DR
 - 03.1206.EQ
 - 03.1206.ER
 - 03.1206.ES

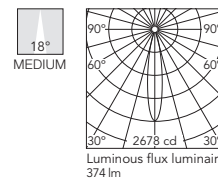

Beam Angle: 18°

h(m)	E(lx)	D(m)
1	2678	0.32
2	669	0.65
3	298	0.97
4	167	1.30
5	107	1.62

Luminous flux luminaire 374 lm

Double Spot Wall Small Ø35

Light Source: Power LED DC 500 mA - 12W - 1020 lm - 2700K/CRI 90 / 12W - 1120 lm - 3000K/CRI 90

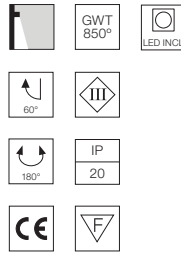
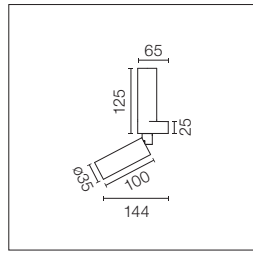

Verstellbare LED-Leuchte für den Innenbereich, geeignet für Wandmontagen. Das Gehäuse kann aus der Installationsfläche herausgezogen werden, so dass eine Ausrichtung von 60° vertikal und 180° horizontal möglich ist. Integrierte Full-Cut-Off optische Gruppe. Integriertes Zubehör (Up Diffusor). Die Fernspeisung (nicht enthalten) muss an einer zugänglichen Stelle angebracht werden. Der Installationsrahmen muss separat bestellt

Adjustable luminaire with LED for indoor use, suitable for wall installation. The lower part of the body can be extracted from the installation surface for 60° orientation on the vertical axis and 180° on the horizontal axis. Integrated Full cut-off optical group. Accessories integrated (up diffuser). The remote power supply (not included) must be placed in an accessible location. The installation frame must be ordered separately

Empfohlene Netzgeräte / Recommended power supply*:

Non Dimmable	60.9592
Dimmable 1-10V	60.9208
Dimmable Dali 2 / Push	60.9186
Casambi	60.9207

* Siehe Treiberkapitel / Refer to the Drivers chapter

- 2700K**
- 03.1210.DY
 - 03.1210.EQ
 - 03.1210.ER
 - 03.1210.ES

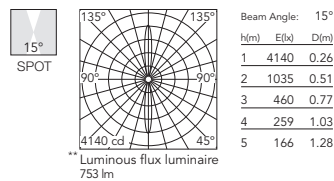

- 3000K**
- 03.1215.DY
 - 03.1215.EQ
 - 03.1215.ER
 - 03.1215.ES

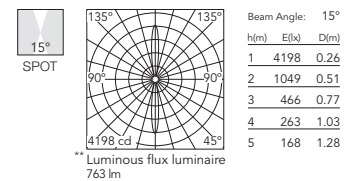

- 2700K**
- 03.1211.DY
 - 03.1211.DR
 - 03.1211.EQ
 - 03.1211.ER
 - 03.1211.ES

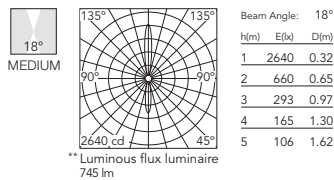

- 3000K**
- 03.1216.DY
 - 03.1216.DR
 - 03.1216.EQ
 - 03.1216.ER
 - 03.1216.ES

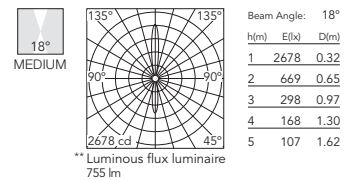

** Photometrische Daten ohne Up Diffusor / Photometric data without up diffuser.

Mono Spot Ceiling Large Ø56

Light Source: Power LED DC 950 mA - 11W - 970 lm - 2700K/CRI 90 / 11W - 1050 lm - 3000K/CRI 90
 Power LED DC 1200 mA - 14W - 1225 lm - 2700K/CRI 90 / 14W - 1300 lm - 3000K/CRI 90

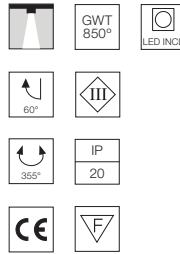
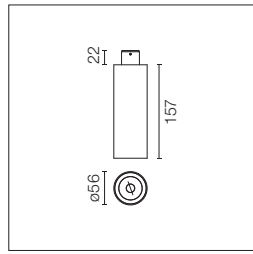

Verstellbare LED-Leuchte für den Innenbereich, geeignet für Deckenmontagen. Das Gehäuse kann aus der Installationsfläche herausgezogen werden, so dass eine Ausrichtung von 60° vertikal und 355° horizontal möglich ist. Integrierte Full-Cut-Off optische Gruppe. Die Fernspeisung (nicht enthalten) muss an einer zugänglichen Stelle angebracht werden. Der Installationsrahmen muss separat bestellt.

Adjustable luminaire with LED for indoor use, suitable for ceiling installation. The body can be extracted from the installation surface for 60° orientation on the vertical axis and 355° on the horizontal axis. Integrated Full cut-off optical group. The remote power supply (not included) must be placed in an accessible location. The installation frame must be ordered separately.

Empfohlene Netzgeräte / Recommended power supply*:

	950 mA	1200 mA
Non Dimmable	60.9162	60.9276
Dimmable Dali 2 / Push	60.9186	60.9276
Dimmable 0/1-10V	60.9439	60.9276
Casambi	60.9207	60.9276+60.9392

* Siehe Treiberkapitel / Refer to the Drivers chapter

- 2700K**
- 03.1250.DYA
 - 03.1250.DRA
 - 03.1250.EQA
 - 03.1250.ERA
 - 03.1250.ESA

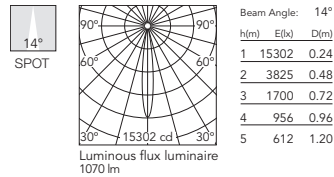

- 3000K**
- 03.1255.DYA
 - 03.1255.DRA
 - 03.1255.EQA
 - 03.1255.ERA
 - 03.1255.ESA

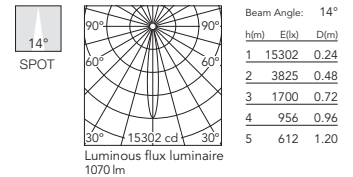

- 2700K**
- 03.1251.DYA
 - 03.1251.DRA
 - 03.1251.EQA
 - 03.1251.ERA
 - 03.1251.ESA

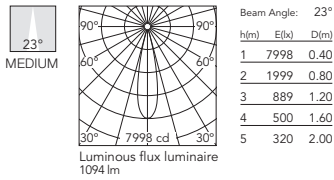

- 3000K**
- 03.1256.DYA
 - 03.1256.DRA
 - 03.1256.EQA
 - 03.1256.ERA
 - 03.1256.ESA

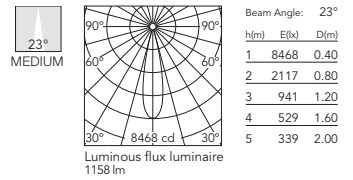

- 2700K**
- 03.1252.DYA
 - 03.1252.DRA
 - 03.1252.EQA
 - 03.1252.ERA
 - 03.1252.ESA

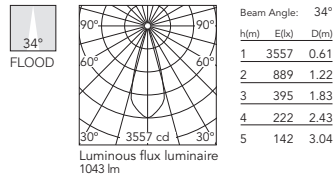

- 3000K**
- 03.1257.DYA
 - 03.1257.DRA
 - 03.1257.EQA
 - 03.1257.ERA
 - 03.1257.ESA

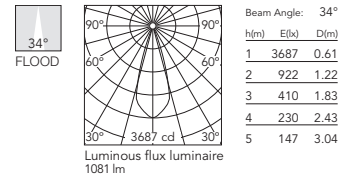

- 2700K**
- 03.1253.DYA
 - 03.1253.DRA
 - 03.1253.EQA
 - 03.1253.ERA
 - 03.1253.ESA

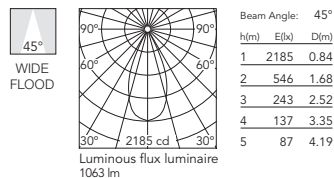

- 3000K**
- 03.1258.DYA
 - 03.1258.DRA
 - 03.1258.EQA
 - 03.1258.ERA
 - 03.1258.ESA

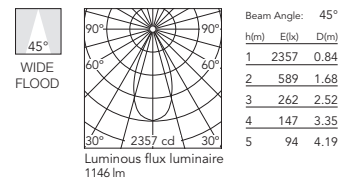

Mono Spot Wall Large Ø56

Light Source: Power LED DC 950 mA - 11W - 970 lm - 2700K/CRI 90 / 11W - 1050 lm - 3000K/CRI 90
 Power LED DC 1200 mA - 14W - 1225 lm - 2700K/CRI 90 / 14W - 1300 lm - 3000K/CRI 90

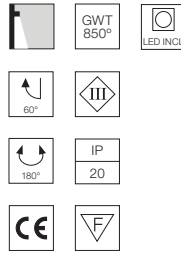
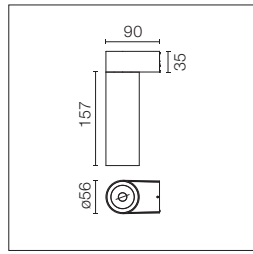

Verstellbare LED-Leuchte für den Innenbereich, geeignet für Wandmontagen. Das Gehäuse kann aus der Installationsfläche herausgezogen werden, so dass eine Ausrichtung von 60° vertikal und 180° horizontal möglich ist. Integrierte Full-Cut-Off optische Gruppe.
 Die Fernspeisung (nicht enthalten) muss an einer zugänglichen Stelle angebracht werden. Der Installationsrahmen muss separat bestellt.

Adjustable luminaire with LED for indoor use, suitable for wall installation. The body can be extracted from the installation surface for 60° orientation on the vertical axis and 180° on the horizontal axis. Integrated Full cut-off optical group. The remote power supply (not included) must be placed in an accessible location. The installation frame must be ordered separately.

Empfohlene Netzgeräte / Recommended power supply*:

	950 mA	1200 mA
Non Dimmable	60.9162	60.9276
Dimmable Dali 2 / Push	60.9186	60.9276
Dimmable 0/1-10V	60.9439	60.9276
Casambi	60.9207	60.9276+60.9392

* Siehe Treiberkapitel / Refer to the Drivers chapter

- 2700K**
- 03.1230.DYA
 - 03.1230.DRA
 - 03.1230.EQA
 - 03.1230.ERA
 - 03.1230.ESA

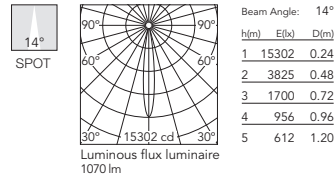

- 3000K**
- 03.1235.DYA
 - 03.1235.DRA
 - 03.1235.EQA
 - 03.1235.ERA
 - 03.1235.ESA

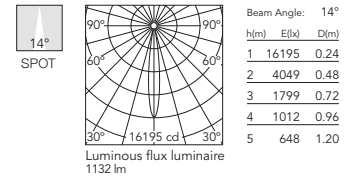

- 2700K**
- 03.1231.DYA
 - 03.1231.DRA
 - 03.1231.EQA
 - 03.1231.ERA
 - 03.1231.ESA

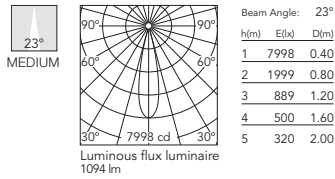

- 3000K**
- 03.1236.DYA
 - 03.1236.DRA
 - 03.1236.EQA
 - 03.1236.ERA
 - 03.1236.ESA

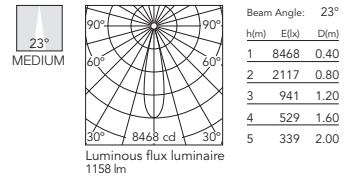

- 2700K**
- 03.1232.DYA
 - 03.1232.DRA
 - 03.1232.EQA
 - 03.1232.ERA
 - 03.1232.ESA

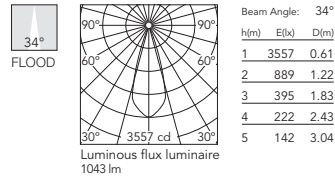

- 3000K**
- 03.1237.DYA
 - 03.1237.DRA
 - 03.1237.EQA
 - 03.1237.ERA
 - 03.1237.ESA

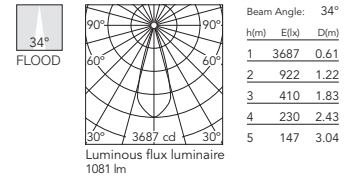

- 2700K**
- 03.1233.DYA
 - 03.1233.DRA
 - 03.1233.EQA
 - 03.1233.ERA
 - 03.1233.ESA

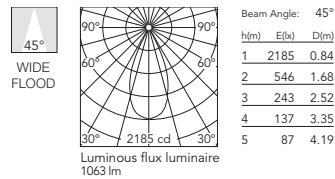

- 3000K**
- 03.1238.DYA
 - 03.1238.DRA
 - 03.1238.EQA
 - 03.1238.ERA
 - 03.1238.ESA

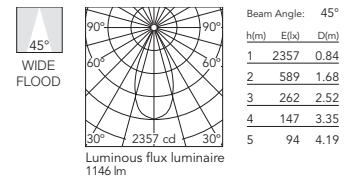

Double Spot Wall Large Ø56

Light Source: Power LED DC 950 mA - 22W - 1940 lm - 2700K/CRI 90 / 22W - 2100 lm - 3000K/CRI 90
 Power LED DC 1200 mA - 28W - 2450 lm - 2700K/CRI 90 / 28W - 2600 lm - 3000K/CRI 90

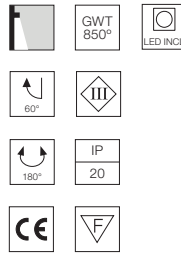
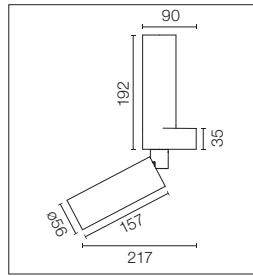

Verstellbare LED-Leuchte für den Innenbereich, geeignet für Wandmontagen. Das untere Gehäuse kann aus der Installationsfläche herausgezogen werden, so dass eine Ausrichtung von 60° vertikal und 180° horizontal möglich ist. Integrierte Full-Cut-Off optische Gruppe. Integriertes Zubehör (Up Diffusor). Die Fernspeisung (nicht enthalten) muss an einer zugänglichen Stelle angebracht werden. Der Installationsrahmen muss separat bestellt

Adjustable luminaire with LED for indoor use, suitable for wall installation. The lower part of the body can be extracted from the installation surface for 60° orientation on the vertical axis and 180° on the horizontal axis. Integrated Full cut-off optical group. Accessories integrated (up diffuser). The remote power supply (not included) must be placed in an accessible location. The installation frame must be ordered separately

Empfohlene Netzgeräte / Recommended power supply*:

	950 mA	1200 mA
Non Dimmable	60.9162	60.9276
Dimmable Dali 2 / Push	60.9186	60.9276
Dimmable 0/1-10V	60.9439	60.9276
Casambi	60.9207	60.9276+60.9392

* Siehe Treiberkapitel / Refer to the Drivers chapter

- 2700K**
- 03.1240.DYA
 - 03.1240.DRA
 - 03.1240.EQA
 - 03.1240.ERA
 - 03.1240.ESA

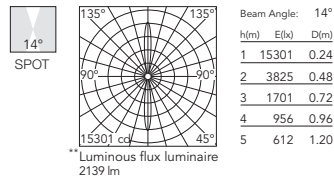

- 3000K**
- 03.1245.DYA
 - 03.1245.DRA
 - 03.1245.EQA
 - 03.1245.ERA
 - 03.1245.ESA

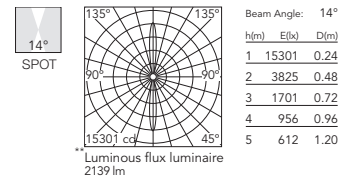

- 2700K**
- 03.1241.DYA
 - 03.1241.DRA
 - 03.1241.EQA
 - 03.1241.ERA
 - 03.1241.ESA

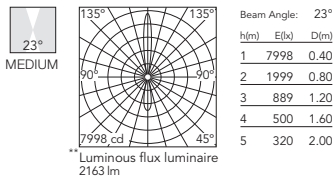

- 3000K**
- 03.1246.DYA
 - 03.1246.DRA
 - 03.1246.EQA
 - 03.1246.ERA
 - 03.1246.ESA

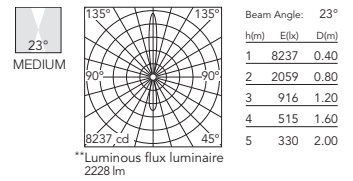

- 2700K**
- 03.1242.DYA
 - 03.1242.DRA
 - 03.1242.EQA
 - 03.1242.ERA
 - 03.1242.ESA

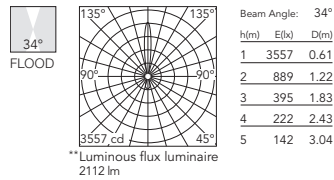

- 3000K**
- 03.1247.DYA
 - 03.1247.DRA
 - 03.1247.EQA
 - 03.1247.ERA
 - 03.1247.ESA

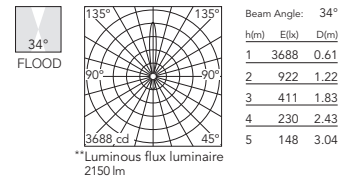

- 2700K**
- 03.1243.DYA
 - 03.1243.DRA
 - 03.1243.EQA
 - 03.1243.ERA
 - 03.1243.ESA

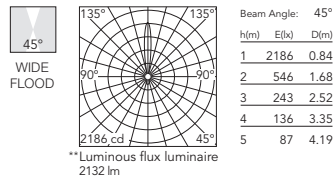

- 3000K**
- 03.1248.DYA
 - 03.1248.DRA
 - 03.1248.EQA
 - 03.1248.ERA
 - 03.1248.ESA

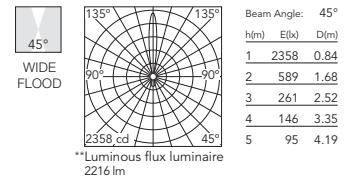

** Photometrische Daten ohne Up Diffusor / Photometric data without up diffuser.

HOW TO ORDER C 1

	SURFACE					RECESSED			
	SMALL			LARGE		SMALL		LARGE	
	Ceiling	Wall	Wall flush	Ceiling	Wall flush	Ceiling	Wall	Ceiling	Wall
Mono Spot									
Mono Spot									
Double Spot									

Zubehör / Accessories

<p>No-Trim-Installierungsrahmen für Wandinstallation.</p>	<p>No Trim installation frame for wall mounting.</p>			<p>C1 Wall Small Mono 08.0206.00 C1 Wall Small Double 08.0227.00</p>
<p>No-Trim-Installierungsrahmen für Wandinstallation.</p>	<p>No Trim installation frame for wall mounting.</p>			<p>C1 Wall Large Mono 08.0205.00A C1 Wall Large Double 08.0226.00A</p>
<p>No-Trim-Installierungsrahmen für Deckeninstallation.</p>	<p>No Trim installation frame for ceiling mounting.</p>			<p>C1 Ceiling Small 08.0208.00</p>
<p>No-Trim-Installierungsrahmen für Deckeninstallation.</p>	<p>No Trim installation frame for ceiling mounting.</p>			<p>C1 Ceiling Large 08.0207.00A</p>
<p>Lackierter Aluminiumträger für Oberflächeninstallation (Wand).</p>	<p>Coated aluminum mount for surface installation (wall).</p>			<p>C1 Wall Small Mono 08.0209.DY 08.0209.DR 08.0209.EQ 08.0209.ER 08.0209.ES C1 Wall Small Double 08.0228.DY 08.0228.DR 08.0228.EQ 08.0228.ER 08.0228.ES</p>
<p>Aluminium-Halterung für den flächenbündigen Einbau (Wand). Geeignet für widerstandsfähige Oberflächen wie Ziegel, Holz oder Beton. Nicht geeignet für Gipskartonwände.</p>	<p>Aluminum mount for surface flush installation (wall). Fit for resistant surfaces such as brick, wood or concrete. Not valid for plasterboard walls.</p>		<p>C1 Wall Small Mono 08.0231.00 C1 Wall Small Double 08.0255.00 C1 Wall Large Mono 08.0210.00A C1 Wall Large Double 08.0254.00A</p>	
<p>Lackierter Aluminiumträger für Oberflächeninstallation (Decke).</p>	<p>Coated aluminum mount for surface installation (ceiling).</p>			<p>C1 Ceiling Small 08.0211.DY 08.0211.DR 08.0211.EQ 08.0211.ER 08.0211.ES</p>
<p>Lackierter Aluminiumträger für Oberflächeninstallation (Decke).</p>	<p>Coated aluminum mount for surface installation (ceiling).</p>			<p>C1 Ceiling Large 08.0212.DYA 08.0212.DRA 08.0212.EQA 08.0212.ERA 08.0212.ESA</p>

UT PRO SURFACE

DESIGNED BY FLOS ARCHITECTURAL

UT PRO SURFACE 150



LIGHT SOURCE
LED ARRAY
23,5W
2300 lm
3000K/CRI 80
1950 lm
3000K/CRI 90
2009 lm
4000K/CRI 90

UT PRO SURFACE 175



LIGHT SOURCE
LED ARRAY
35,3W
4145 lm
3000K/CRI 80
3425 lm
3000K/CRI 90
3569 lm
4000K/CRI 90

□ 40 Weiss
40 White



■ 14 Schwarz
14 Black



Produktbeschreibung

Innenleuchte zur Installation auf der Oberfläche, erhältlich mit Hochleistungs-LED-Technologie Lichtquellen und Regler.

Der optische Leuchtenkörper sowie das Netzgerätgehäuse sind aus Aluminium Hochdruckguss mit Pulverbeschichtung in Weiß oder Schwarz gefertigt. Zu den Leuchten gehören Netzanschlussgeräte im Leuchtenkörper.

Optisches System

Spot, Medium und Flood Optik erhältlich und besitzen einen hocheffizienten Reflektor aus Borosilikatglas.

Zubehör

Querabschirmung, elliptische Linse, Flood und Honeycomb Linse.

Zusatzinformationen

360° vertikale und 90° horizontale Drehung möglich. Einrastmechanismus für die horizontale Achse integriert. Schutzgrad IP20.

Qualitätszeichen

Das Gerät entspricht der europäischen technischen Norm EN60598-1 und den entsprechenden Zusatzregelungen.

Description

Indoor luminaire for surface installation, available in high power, LED technology light sources and regulator included.

The optical housing of the luminaire, as well as the container of the power supply equipment, is manufactured in high-pressure injected aluminium, with white or black finishes.

The luminaires include a power supply unit in the luminaire's own body.

Optic System

Available with spot, medium and flood optics and a built-in high-efficiency borosilicate glass reflector.

Accessories

Shielding cylinder, elliptical lens, flood and honeycomb lens.

Additional Information

Possibility of 360° rotation in the vertical axis and 90° rotation in the horizontal axis. Blocking mechanism for horizontal axis integrated. IP20 protection grade.

Compliance of Standards and Quality Marks

EN60598-1 European Technical Standards and any subsequent additions.

UT PRO SURFACE

UT Pro Surface 150

Light Source: LED Array 23,5W - 2300 lm - 3000K/CRI 80 / 23,5W - 1950 lm - 3000K/CRI 90 / 23,5W - 2009 lm - 4000K/CRI 90

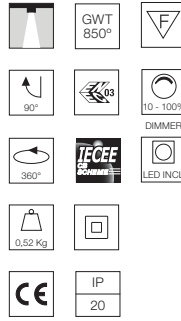
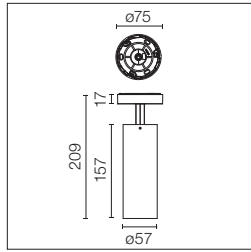

Projektor zur Installation auf der Oberfläche mit LED-Lichtquelle. Netzteil 120-277V und Potentiometer enthalten.

LED light source projector for surface installation. 120-277V power supply unit and potentiometer included.

3000K - CRI 80
On board dimmer
09.7290.40A
09.7290.14A

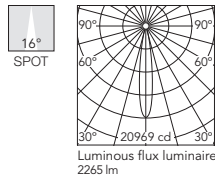

3000K - CRI 90
On board dimmer
09.7296.40A
09.7296.14A

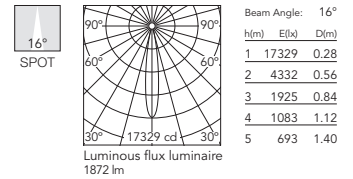

4000K - CRI 90
On board dimmer
09.7291.40A
09.7291.14A

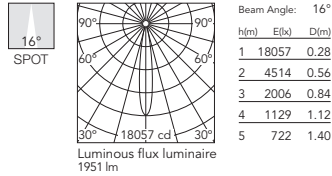

3000K - CRI 80
On board dimmer
09.7292.40A
09.7292.14A

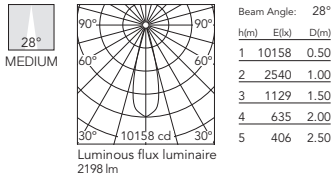

3000K - CRI 90
On board dimmer
09.7297.40A
09.7297.14A

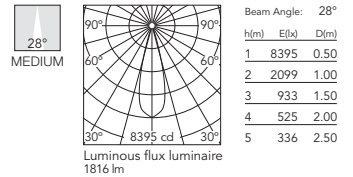

4000K - CRI 90
On board dimmer
09.7293.40A
09.7293.14A

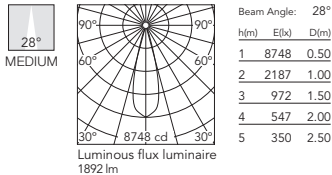

3000K - CRI 80
On board dimmer
09.7294.40A
09.7294.14A

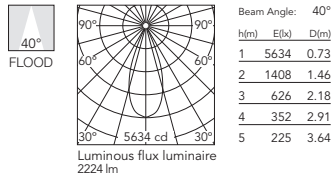

3000K - CRI 90
On board dimmer
09.7298.40A
09.7298.14A

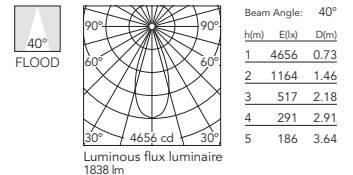

4000K - CRI 90
On board dimmer
09.7295.40A
09.7295.14A

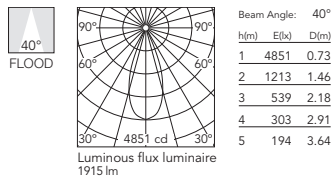

UT PRO SURFACE

UT Pro Surface 175

Light Source: LED Array 35,3W - 3950 lm - 3000K/CRI 80 / 35,3W - 3250 lm - 3000K/CRI 90 / 35,3W - 3400 lm - 4000K/CRI 90

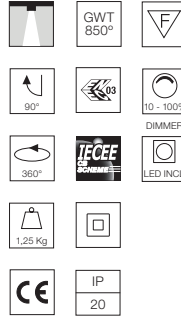
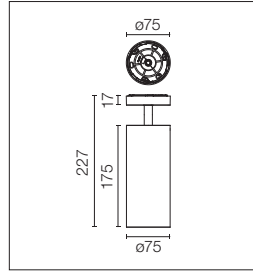

Projektor zur Installation auf der Oberfläche mit LED-Lichtquelle. Netzteil 120-277V und Potentiometer enthalten.

LED light source projector for surface installation. 120-277V power supply unit and potentiometer included.

3000K - CRI 80
On board dimmer
09.7320.40
09.7320.14

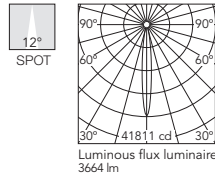

3000K - CRI 90
On board dimmer
09.7321.40
09.7321.14

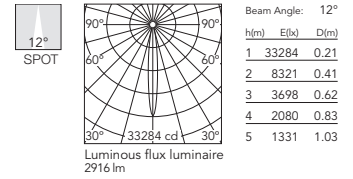

4000K - CRI 90
On board dimmer
09.7322.40
09.7322.14

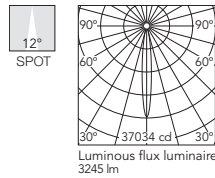

3000K - CRI 90
On board dimmer
09.7324.40
09.7324.14

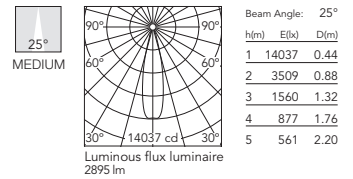

3000K - CRI 80
On board dimmer
09.7323.40
09.7323.14

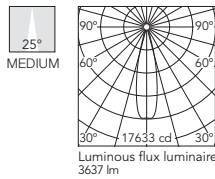

4000K - CRI 90
On board dimmer
09.7325.40
09.7325.14

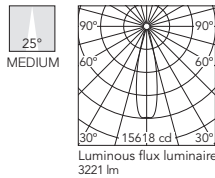

3000K - CRI 90
On board dimmer
09.7327.40
09.7327.14

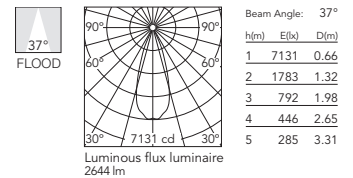

3000K - CRI 80
On board dimmer
09.7326.40
09.7326.14

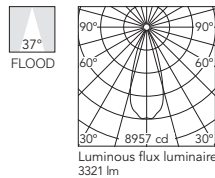

4000K - CRI 90
On board dimmer
09.7328.40
09.7328.14

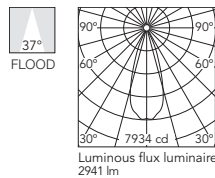







UT PRO SURFACE

Zubehör / Accessories

Querabschirmung, Linsen und Honeycomb können ohne Befestigungszubehör direkt in den Leuchtenkopf eingesetzt werden. Honeycomb + Linse können gleichzeitig verwendet werden.

Screening crosspiece, lenses and honeycomb directly installable on the head of the luminaire without needing any fastening accessory. Installation compatible with honeycomb + lense at the same time.

Querabschirmung.	Screening crosspiece.		UT Pro Surface 150 08.8429.00 UT Pro Surface 175 08.9108.00
Elliptische linse.	Elliptical lens.		UT Pro Surface 150 08.8431.00 UT Pro Surface 175 08.9109.00
Floodlinse.	Flood lens.		UT Pro Surface 150 08.8432.00 UT Pro Surface 175 08.9110.00
Honeycomb.	Honeycomb.		UT Pro Surface 150 08.8428.00 UT Pro Surface 175 08.9107.00
Konische Abschirmung.	Snoot shielding cone.		 UT Pro Surface 150 08.0526.00 08.0526.40 08.0526.BW UT Pro Surface 175 08.9111.00

KAP SURFACE&SUSPENSION

DESIGNED BY FLOS ARCHITECTURAL



Außen / Outside

- B1 Weiss
B1 White
- 14 Schwarz
14 Black
- 18 Deep Brown
18 Deep Brown

Innen / Inside

- Weiss
White
- Mattgold
Matt Gold
- Kupfer
Copper
- Schwarz
Black

Kap 80
Round / Square



Außen / Outside

- 11 Weiss
11 White
- AS Gebürstetes Aluminium
AS Brushed Aluminium
- AN Schwarz
AN Black
- B3 Braun
B3 Brown

Innen / Inside

- Weiss
White
- Mattgold
Matt Gold
- Blau
Blue
- Schwarz
Black

Kap Ø100



KAP SURFACE & SUSPENSION

Produktbeschreibung

Leuchten Produktlinie mit direkter Beleuchtung oder mit direkter und indirekter Beleuchtung je nach Version zur Installation an Decken, Wänden oder hängend. Die Ø80 Version gibt es in der Ausführung mit runden und quadratischen Leuchtmodulen.

Die Haupteinheit der Leuchte besteht aus extrudiertem Aluminium.

Die Kap 80 Surface ist in drei externen Ausführungen (weiß, schwarz und deep brown) und vier internen Ausführungen (weiß, matt gold, kupfer und schwarz) erhältlich.

Die anderen Versionen sind in vier externen Ausführungen (weiß, poliertes Aluminium, schwarz und braun) und vier internen Ausführungen (weiß, matt gold, blau und schwarz) erhältlich.

Reflektoren

Die Ø100 Version besitzt einen Innenstrahler aus farbigem Polycarbonat und die Ø80 Version einen Strahler aus farbigem Aluminium. Zudem besitzen beide Ausführungen eine Licht streuende Linse aus weißem Polycarbonat für eine gleichmäßige Ausleuchtung.

Betriebsgerät

Elektronischer Transformator eingebaut.

Zusatzinformationen

Schutzgrad IP20.

Schutzklasse I.

Auf normal entflammaren Oberflächen einsetzbar.

Qualitätszeichen

Das Gerät entspricht der europäischen technischen Norm EN60598-1 und den entsprechenden Zusatzregelungen.

Description

Family of luminaires with direct or indirect lighting depending on the version, to be installed on ceilings, walls or suspended. Version Ø80 comes with round or square lighting modules.

The main body of the luminaire is made of extruded aluminum.

Kap 80 Surface version is available in three external finishes (black, white and deep brown) and four internal finishes (white, matt gold, copper and black).

The other versions are available in four external finishes (white, polished aluminium, black and brown) and four internal finishes (white, matt gold, blue and black).

Reflectors

Version Ø100 has an internal reflector in painted polycarbonate in its internal part, while version Ø80 has a reflector in painted aluminium. Furthermore, both versions incorporate a diffusing lens in opal polycarbonate to ensure uniform light distribution.

Power Supply

Electronic transformer incorporated.

Additional Information

IP20 protection grade.

Insulation class I.

Suitable for installation on normally inflammable surfaces.

Standard Compliance and Quality Marks

EN60598-1 European Technical Standards and any subsequent additions.



Ceiling



Suspension



Wall

KAP SURFACE

Kap 80 Surface Ceiling Round - Optic Spot / Optic Medium

Light Source: LED Array 9,2W - 935 lm - 2700K/CRI 90 / 9,2W - 974 lm - 3000K/CRI 90

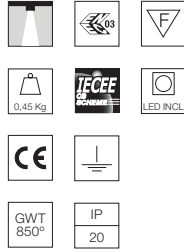
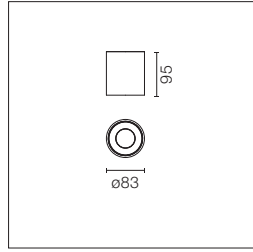

LED Einbauleuchte.
Stromversorgung in den
Leuchtkörper integriert.
Non dimmable 110/240V -
Main&Dali/Push dimmable
220/240V.

E= Außenfarbe
I= Innenfarbe

Luminaire for mounting on the
ceiling with LED light source. Power
source incorporated into luminaire
body. Non dimmable 110/240V -
Main&Dali/Push dimmable
220/240V.

E= External Finish
I= Internal Finish

Optic Spot 2700K

E	I	Non Dimmable
□	□	03.6020.B1
□	□	03.6020.14
□	□	03.6020.18
Mains Dimming		
□	□	03.5920.B1
□	□	03.5920.14
□	□	03.5920.18
Dali/Push Version		
□	□	03.6020.B1.DA
□	□	03.6020.14.DA
□	□	03.6020.18.DA

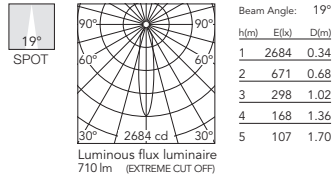

Optic Spot 3000K

E	I	Non Dimmable
□	□	03.6024.B1
□	□	03.6024.14
□	□	03.6024.18
Mains Dimming		
□	□	03.5924.B1
□	□	03.5924.14
□	□	03.5924.18
Dali/Push Version		
□	□	03.6024.B1.DA
□	□	03.6024.14.DA
□	□	03.6024.18.DA

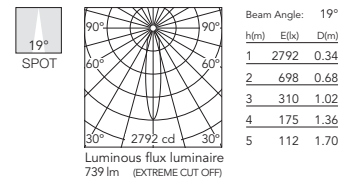

E	I	Non Dimmable
□	□	03.6021.B1
□	□	03.6021.14
□	□	03.6021.18
Mains Dimming		
□	□	03.5921.B1
□	□	03.5921.14
□	□	03.5921.18
Dali/Push Version		
□	□	03.6021.B1.DA
□	□	03.6021.14.DA
□	□	03.6021.18.DA

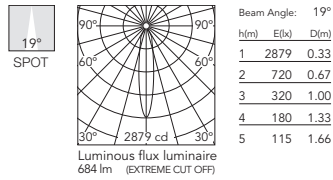

E	I	Non Dimmable
□	□	03.6025.B1
□	□	03.6025.14
□	□	03.6025.18
Mains Dimming		
□	□	03.5925.B1
□	□	03.5925.14
□	□	03.5925.18
Dali/Push Version		
□	□	03.6025.B1.DA
□	□	03.6025.14.DA
□	□	03.6025.18.DA

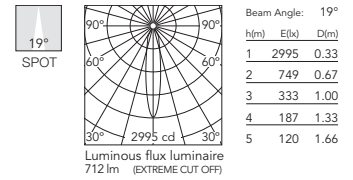

E	I	Non Dimmable
□	□	03.6022.B1
□	□	03.6022.14
□	□	03.6022.18
Mains Dimming		
□	□	03.5922.B1
□	□	03.5922.14
□	□	03.5922.18
Dali/Push Version		
□	□	03.6022.B1.DA
□	□	03.6022.14.DA
□	□	03.6022.18.DA

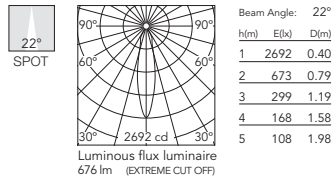

E	I	Non Dimmable
□	□	03.6026.B1
□	□	03.6026.14
□	□	03.6026.18
Mains Dimming		
□	□	03.5926.B1
□	□	03.5926.14
□	□	03.5926.18
Dali/Push Version		
□	□	03.6026.B1.DA
□	□	03.6026.14.DA
□	□	03.6026.18.DA

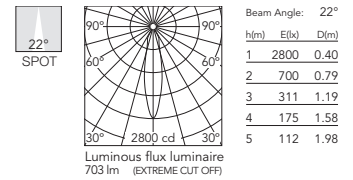

E	I	Non Dimmable
□	□	03.6023.B1
□	□	03.6023.14
□	□	03.6023.18
Mains Dimming		
□	□	03.5923.B1
□	□	03.5923.14
□	□	03.5923.18
Dali/Push Version		
□	□	03.6023.B1.DA
□	□	03.6023.14.DA
□	□	03.6023.18.DA

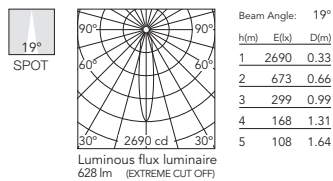

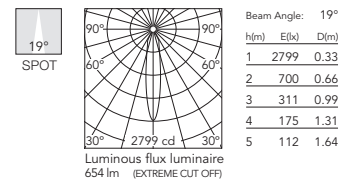

E	I	Non Dimmable
□	□	03.6027.B1
□	□	03.6027.14
□	□	03.6027.18
Mains Dimming		
□	□	03.5927.B1
□	□	03.5927.14
□	□	03.5927.18
Dali/Push Version		
□	□	03.6027.B1.DA
□	□	03.6027.14.DA
□	□	03.6027.18.DA





KAP SURFACE

Optic Medium 2700K

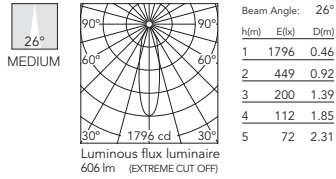

 Non Dimmable
 03.6000.B1
 03.6000.14
 03.6000.18
 Mains Dimming
 03.5900.B1
 03.5900.14
 03.5900.18
 Dali/Push Version
 03.6000.B1.DA
 03.6000.14.DA
 03.6000.18.DA





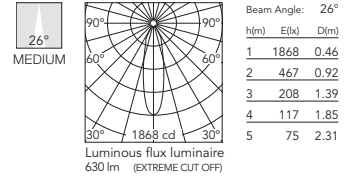

Optic Medium 3000K

 Non Dimmable
 03.6004.B1
 03.6004.14
 03.6004.18
 Mains Dimming
 03.5904.B1
 03.5904.14
 03.5904.18
 Dali/Push Version
 03.6004.B1.DA
 03.6004.14.DA
 03.6004.18.DA

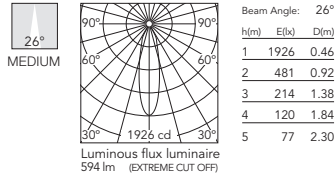



 Non Dimmable
 03.6001.B1
 03.6001.14
 03.6001.18
 Mains Dimming
 03.5901.B1
 03.5901.14
 03.5901.18
 Dali/Push Version
 03.6001.B1.DA
 03.6001.14.DA
 03.6001.18.DA



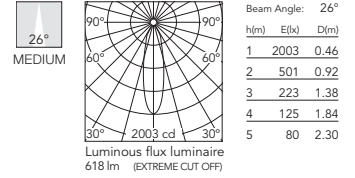

 Non Dimmable
 03.6005.B1
 03.6005.14
 03.6005.18
 Mains Dimming
 03.5905.B1
 03.5905.14
 03.5905.18
 Dali/Push Version
 03.6005.B1.DA
 03.6005.14.DA
 03.6005.18.DA



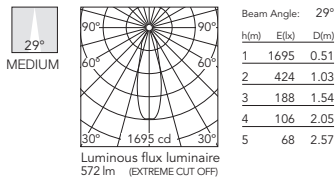

 Non Dimmable
 03.6002.B1
 03.6002.14
 03.6002.18
 Mains Dimming
 03.5902.B1
 03.5902.14
 03.5902.18
 Dali/Push Version
 03.6002.B1.DA
 03.6002.14.DA
 03.6002.18.DA



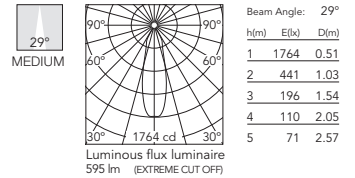

 Non Dimmable
 03.6006.B1
 03.6006.14
 03.6006.18
 Mains Dimming
 03.5906.B1
 03.5906.14
 03.5906.18
 Dali/Push Version
 03.6006.B1.DA
 03.6006.14.DA
 03.6006.18.DA

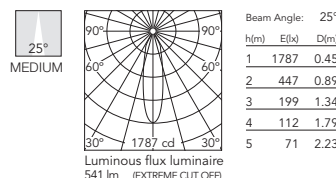

 Non Dimmable
 03.6003.B1
 03.6003.14
 03.6003.18
 Mains Dimming
 03.5903.B1
 03.5903.14
 03.5903.18
 Dali/Push Version
 03.6003.B1.DA
 03.6003.14.DA
 03.6003.18.DA



 Non Dimmable
 03.6007.B1
 03.6007.14
 03.6007.18
 Mains Dimming
 03.5907.B1
 03.5907.14
 03.5907.18
 Dali/Push Version
 03.6007.B1.DA
 03.6007.14.DA
 03.6007.18.DA

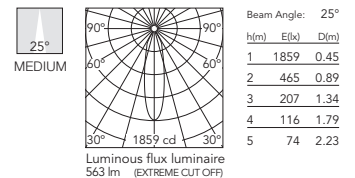

KAP SURFACE

Kap 80 Surface Ceiling Round - Optic Flood

Light Source: LED Array 9,2W - 935 lm - 2700K/CRI 90 / 9,2W - 974 lm - 3000K/CRI 90

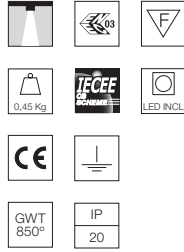
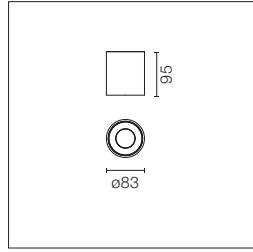

LED Einbauleuchte.
Stromversorgung in den
Leuchtkörper integriert.
Non dimmable 110/240V -
Main&Dali/Push dimmable
220/240V.

E= Außenfarbe
I= Innenfarbe

Luminaire for mounting on the
ceiling with LED light source. Power
source incorporated into luminaire
body. Non dimmable 110/240V -
Main&Dali/Push dimmable
220/240V.

E= External Finish
I= Internal Finish

Optic Flood 2700K

E	I	Non Dimmable
□	□	03.6040.B1
□	■	03.6040.14
■	■	03.6040.18
Mains Dimming		
□	□	03.5940.B1
□	■	03.5940.14
■	■	03.5940.18
Dali/Push Version		
□	□	03.6040.B1.DA
□	■	03.6040.14.DA
■	■	03.6040.18.DA

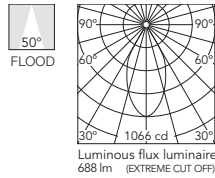

Beam Angle: 50°	h(m)	E lx	D(m)
1	1066	0.93	
2	266	1.86	
3	118	2.79	
4	67	3.72	
5	43	4.65	

Optic Flood 3000K

E	I	Non Dimmable
□	□	03.6044.B1
□	■	03.6044.14
■	■	03.6044.18
Mains Dimming		
□	□	03.5944.B1
□	■	03.5944.14
■	■	03.5944.18
Dali/Push Version		
□	□	03.6044.B1.DA
□	■	03.6044.14.DA
■	■	03.6044.18.DA

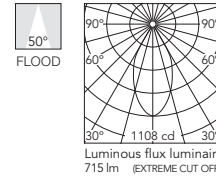

Beam Angle: 50°	h(m)	E lx	D(m)
1	1108	0.93	
2	277	1.86	
3	123	2.79	
4	69	3.72	
5	44	4.65	

E	I	Non Dimmable
□	■	03.6041.B1
□	■	03.6041.14
■	■	03.6041.18
Mains Dimming		
□	■	03.5941.B1
□	■	03.5941.14
■	■	03.5941.18
Dali/Push Version		
□	■	03.6041.B1.DA
□	■	03.6041.14.DA
■	■	03.6041.18.DA

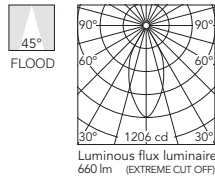

Beam Angle: 45°	h(m)	E lx	D(m)
1	1206	0.83	
2	302	1.66	
3	134	2.48	
4	75	3.31	
5	48	4.14	

E	I	Non Dimmable
□	■	03.6045.B1
□	■	03.6045.14
■	■	03.6045.18
Mains Dimming		
□	■	03.5945.B1
□	■	03.5945.14
■	■	03.5945.18
Dali/Push Version		
□	■	03.6045.B1.DA
□	■	03.6045.14.DA
■	■	03.6045.18.DA

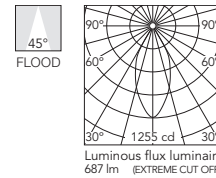

Beam Angle: 45°	h(m)	E lx	D(m)
1	1255	0.83	
2	314	1.66	
3	139	2.48	
4	78	3.31	
5	50	4.14	

E	I	Non Dimmable
□	■	03.6042.B1
□	■	03.6042.14
■	■	03.6042.18
Mains Dimming		
□	■	03.5942.B1
□	■	03.5942.14
■	■	03.5942.18
Dali/Push Version		
□	■	03.6042.B1.DA
□	■	03.6042.14.DA
■	■	03.6042.18.DA

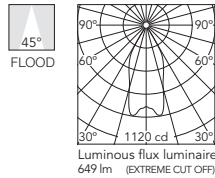

Beam Angle: 45°	h(m)	E lx	D(m)
1	1120	0.83	
2	280	1.66	
3	124	2.49	
4	70	3.32	
5	45	4.14	

E	I	Non Dimmable
□	■	03.6046.B1
□	■	03.6046.14
■	■	03.6046.18
Mains Dimming		
□	■	03.5946.B1
□	■	03.5946.14
■	■	03.5946.18
Dali/Push Version		
□	■	03.6046.B1.DA
□	■	03.6046.14.DA
■	■	03.6046.18.DA

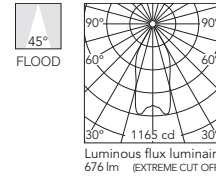

Beam Angle: 45°	h(m)	E lx	D(m)
1	1165	0.83	
2	291	1.66	
3	129	2.49	
4	73	3.32	
5	47	4.14	

E	I	Non Dimmable
□	■	03.6043.B1
□	■	03.6043.14
■	■	03.6043.18
Mains Dimming		
□	■	03.5943.B1
□	■	03.5943.14
■	■	03.5943.18
Dali/Push Version		
□	■	03.6043.B1.DA
□	■	03.6043.14.DA
■	■	03.6043.18.DA

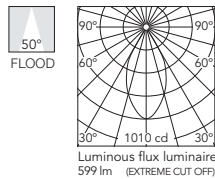

Beam Angle: 50°	h(m)	E lx	D(m)
1	1010	0.94	
2	252	1.89	
3	112	2.83	
4	63	3.77	
5	40	4.72	

E	I	Non Dimmable
□	■	03.6047.B1
□	■	03.6047.14
■	■	03.6047.18
Mains Dimming		
□	■	03.5947.B1
□	■	03.5947.14
■	■	03.5947.18
Dali/Push Version		
□	■	03.6047.B1.DA
□	■	03.6047.14.DA
■	■	03.6047.18.DA

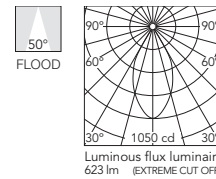

Beam Angle: 50°	h(m)	E lx	D(m)
1	1050	0.94	
2	263	1.89	
3	117	2.83	
4	66	3.77	
5	42	4.72	

KAP SURFACE

Kap 80 Surface Ceiling Square - Optic Spot

Light Source: LED Array 9,2W - 935 lm - 2700K/CRI 90 / 9,2W - 974 lm - 3000K/CRI 90

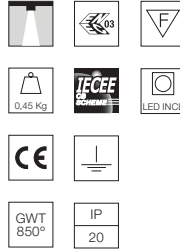
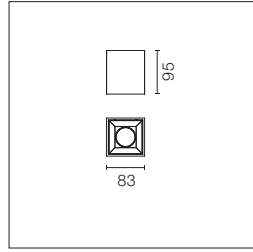

LED Einbauleuchte.
Stromversorgung in den
Leuchtkörper integriert.
Non dimmable 110/240V -
Main&Dali/Push dimmable
220/240V.

E= Außenfarbe
I= Innenfarbe

Luminaire for mounting on the
ceiling with LED light source. Power
source incorporated into luminaire
body. Non dimmable 110/240V -
Main&Dali/Push dimmable
220/240V.

E= External Finish
I= Internal Finish

Optic Spot 2700K

- | | | |
|-------------------|---|---------------|
| E | I | Non Dimmable |
| ■ | ■ | 03.6030.B1 |
| ■ | ■ | 03.6030.14 |
| ■ | ■ | 03.6030.18 |
| Mains Dimming | | |
| ■ | ■ | 03.5930.B1 |
| ■ | ■ | 03.5930.14 |
| ■ | ■ | 03.5930.18 |
| Dali/Push Version | | |
| ■ | ■ | 03.6030.B1.DA |
| ■ | ■ | 03.6030.14.DA |
| ■ | ■ | 03.6030.18.DA |

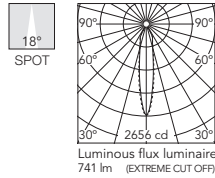

h(m)	E(lx)	D(m)
1	2656	0.31
2	664	0.62
3	295	0.94
4	166	1.25
5	106	1.56

Optic Spot 3000K

- | | | |
|-------------------|---|---------------|
| E | I | Non Dimmable |
| ■ | ■ | 03.6034.B1 |
| ■ | ■ | 03.6034.14 |
| ■ | ■ | 03.6034.18 |
| Mains Dimming | | |
| ■ | ■ | 03.5934.B1 |
| ■ | ■ | 03.5934.14 |
| ■ | ■ | 03.5934.18 |
| Dali/Push Version | | |
| ■ | ■ | 03.6034.B1.DA |
| ■ | ■ | 03.6034.14.DA |
| ■ | ■ | 03.6034.18.DA |

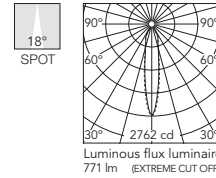

h(m)	E(lx)	D(m)
1	2762	0.31
2	691	0.62
3	307	0.94
4	173	1.25
5	110	1.56

- | | | |
|-------------------|---|---------------|
| E | I | Non Dimmable |
| ■ | ■ | 03.6031.B1 |
| ■ | ■ | 03.6031.14 |
| ■ | ■ | 03.6031.18 |
| Mains Dimming | | |
| ■ | ■ | 03.5931.B1 |
| ■ | ■ | 03.5931.14 |
| ■ | ■ | 03.5931.18 |
| Dali/Push Version | | |
| ■ | ■ | 03.6031.B1.DA |
| ■ | ■ | 03.6031.14.DA |
| ■ | ■ | 03.6031.18.DA |

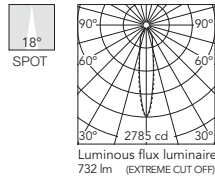

h(m)	E(lx)	D(m)
1	2785	0.31
2	696	0.63
3	309	0.94
4	174	1.26
5	111	1.57

- | | | |
|-------------------|---|---------------|
| E | I | Non Dimmable |
| ■ | ■ | 03.6035.B1 |
| ■ | ■ | 03.6035.14 |
| ■ | ■ | 03.6035.18 |
| Mains Dimming | | |
| ■ | ■ | 03.5935.B1 |
| ■ | ■ | 03.5935.14 |
| ■ | ■ | 03.5935.18 |
| Dali/Push Version | | |
| ■ | ■ | 03.6035.B1.DA |
| ■ | ■ | 03.6035.14.DA |
| ■ | ■ | 03.6035.18.DA |

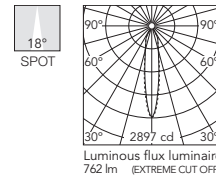

h(m)	E(lx)	D(m)
1	2897	0.31
2	724	0.63
3	322	0.94
4	181	1.26
5	116	1.57

- | | | |
|-------------------|---|---------------|
| E | I | Non Dimmable |
| ■ | ■ | 03.6032.B1 |
| ■ | ■ | 03.6032.14 |
| ■ | ■ | 03.6032.18 |
| Mains Dimming | | |
| ■ | ■ | 03.5932.B1 |
| ■ | ■ | 03.5932.14 |
| ■ | ■ | 03.5932.18 |
| Dali/Push Version | | |
| ■ | ■ | 03.6032.B1.DA |
| ■ | ■ | 03.6032.14.DA |
| ■ | ■ | 03.6032.18.DA |

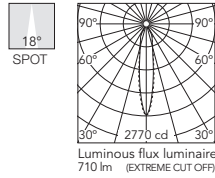

h(m)	E(lx)	D(m)
1	2770	0.31
2	693	0.62
3	308	0.94
4	173	1.25
5	111	1.56

- | | | |
|-------------------|---|---------------|
| E | I | Non Dimmable |
| ■ | ■ | 03.6036.B1 |
| ■ | ■ | 03.6036.14 |
| ■ | ■ | 03.6036.18 |
| Mains Dimming | | |
| ■ | ■ | 03.5936.B1 |
| ■ | ■ | 03.5936.14 |
| ■ | ■ | 03.5936.18 |
| Dali/Push Version | | |
| ■ | ■ | 03.6036.B1.DA |
| ■ | ■ | 03.6036.14.DA |
| ■ | ■ | 03.6036.18.DA |

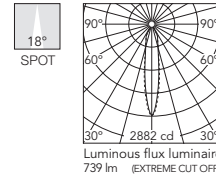

h(m)	E(lx)	D(m)
1	2882	0.31
2	720	0.62
3	320	0.94
4	180	1.25
5	115	1.56

- | | | |
|-------------------|---|---------------|
| E | I | Non Dimmable |
| ■ | ■ | 03.6033.B1 |
| ■ | ■ | 03.6033.14 |
| ■ | ■ | 03.6033.18 |
| Mains Dimming | | |
| ■ | ■ | 03.5933.B1 |
| ■ | ■ | 03.5933.14 |
| ■ | ■ | 03.5933.18 |
| Dali/Push Version | | |
| ■ | ■ | 03.6033.B1.DA |
| ■ | ■ | 03.6033.14.DA |
| ■ | ■ | 03.6033.18.DA |

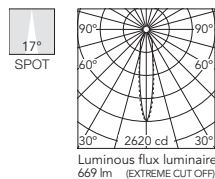

h(m)	E(lx)	D(m)
1	2620	0.30
2	655	0.60
3	291	0.90
4	164	1.20
5	105	1.50

- | | | |
|-------------------|---|---------------|
| E | I | Non Dimmable |
| ■ | ■ | 03.6037.B1 |
| ■ | ■ | 03.6037.14 |
| ■ | ■ | 03.6037.18 |
| Mains Dimming | | |
| ■ | ■ | 03.5937.B1 |
| ■ | ■ | 03.5937.14 |
| ■ | ■ | 03.5937.18 |
| Dali/Push Version | | |
| ■ | ■ | 03.6037.B1.DA |
| ■ | ■ | 03.6037.14.DA |
| ■ | ■ | 03.6037.18.DA |

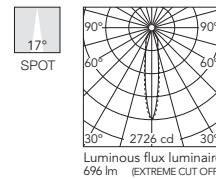

h(m)	E(lx)	D(m)
1	2726	0.30
2	681	0.60
3	303	0.90
4	170	1.20
5	109	1.50

KAP SURFACE

Kap 80 Surface Ceiling Square - Optic Medium / Optic Flood

Light Source: LED Array 9,2W - 935 lm - 2700K/CRI 90 / 9,2W - 974 lm - 3000K/CRI 90

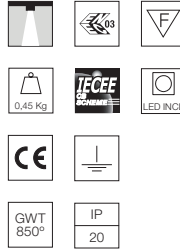
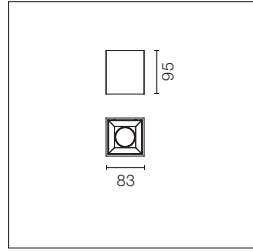

LED Einbauleuchte.
Stromversorgung in den
Leuchtkörper integriert.
Non dimmable 110/240V -
Main&Dali/Push dimmable
220/240V.

E= Außenfarbe
I= Innenfarbe

Luminaire for mounting on the
ceiling with LED light source. Power
source incorporated into luminaire
body. Non dimmable 110/240V -
Main&Dali/Push dimmable
220/240V.

E= External Finish
I= Internal Finish

Optic Medium 2700K

E	I	Non Dimmable
■	■	03.6010.B1
■	■	03.6010.14
■	■	03.6010.18
Mains Dimming		
■	■	03.5910.B1
■	■	03.5910.14
■	■	03.5910.18
Dali/Push Version		
■	■	03.6010.B1.DA
■	■	03.6010.14.DA
■	■	03.6010.18.DA

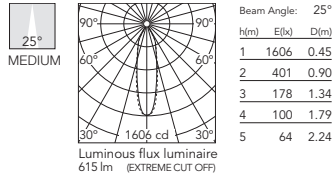

Optic Medium 3000K

E	I	Non Dimmable
■	■	03.6014.B1
■	■	03.6014.14
■	■	03.6014.18
Mains Dimming		
■	■	03.5914.B1
■	■	03.5914.14
■	■	03.5914.18
Dali/Push Version		
■	■	03.6014.B1.DA
■	■	03.6014.14.DA
■	■	03.6014.18.DA

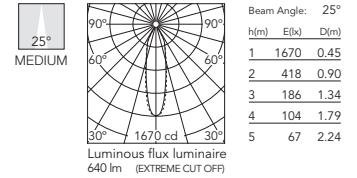

E	I	Non Dimmable
■	■	03.6011.B1
■	■	03.6011.14
■	■	03.6011.18
Mains Dimming		
■	■	03.5911.B1
■	■	03.5911.14
■	■	03.5911.18
Dali/Push Version		
■	■	03.6011.B1.DA
■	■	03.6011.14.DA
■	■	03.6011.18.DA

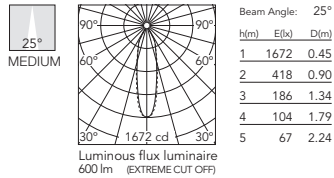

E	I	Non Dimmable
■	■	03.6015.B1
■	■	03.6015.14
■	■	03.6015.18
Mains Dimming		
■	■	03.5915.B1
■	■	03.5915.14
■	■	03.5915.18
Dali/Push Version		
■	■	03.6015.B1.DA
■	■	03.6015.14.DA
■	■	03.6015.18.DA

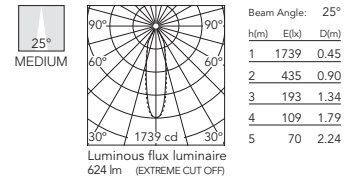

E	I	Non Dimmable
■	■	03.6012.B1
■	■	03.6012.14
■	■	03.6012.18
Mains Dimming		
■	■	03.5912.B1
■	■	03.5912.14
■	■	03.5912.18
Dali/Push Version		
■	■	03.6012.B1.DA
■	■	03.6012.14.DA
■	■	03.6012.18.DA

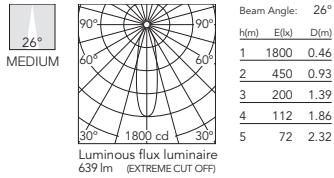

E	I	Non Dimmable
■	■	03.6016.B1
■	■	03.6016.14
■	■	03.6016.18
Mains Dimming		
■	■	03.5916.B1
■	■	03.5916.14
■	■	03.5916.18
Dali/Push Version		
■	■	03.6016.B1.DA
■	■	03.6016.14.DA
■	■	03.6016.18.DA

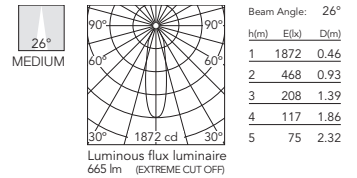

E	I	Non Dimmable
■	■	03.6013.B1
■	■	03.6013.14
■	■	03.6013.18
Mains Dimming		
■	■	03.5913.B1
■	■	03.5913.14
■	■	03.5913.18
Dali/Push Version		
■	■	03.6013.B1.DA
■	■	03.6013.14.DA
■	■	03.6013.18.DA

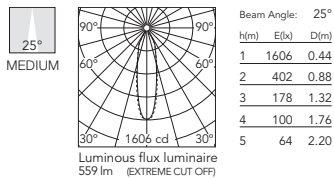

E	I	Non Dimmable
■	■	03.6017.B1
■	■	03.6017.14
■	■	03.6017.18
Mains Dimming		
■	■	03.5917.B1
■	■	03.5917.14
■	■	03.5917.18
Dali/Push Version		
■	■	03.6017.B1.DA
■	■	03.6017.14.DA
■	■	03.6017.18.DA

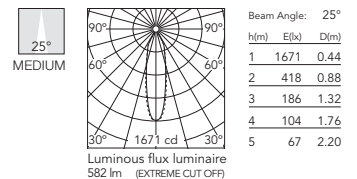

KAP SURFACE

Optic Flood 2700K

Non Dimmable
 03.6050.B1
 03.6050.14
 03.6050.18
 Mains Dimming
 03.5950.B1
 03.5950.14
 03.5950.18
 Dali/Push Version
 03.6050.B1.DA
 03.6050.14.DA
 03.6050.18.DA

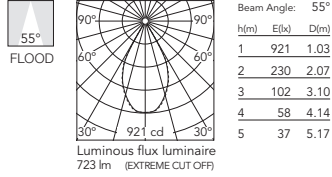

Optic Flood 3000K

Non Dimmable
 03.6054.B1
 03.6054.14
 03.6054.18
 Mains Dimming
 03.5954.B1
 03.5954.14
 03.5954.18
 Dali/Push Version
 03.6054.B1.DA
 03.6054.14.DA
 03.6054.18.DA

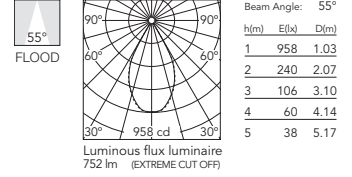

Non Dimmable
 03.6051.B1
 03.6051.14
 03.6051.18
 Mains Dimming
 03.5951.B1
 03.5951.14
 03.5951.18
 Dali/Push Version
 03.6051.B1.DA
 03.6051.14.DA
 03.6051.18.DA

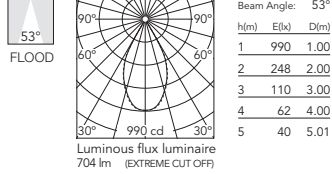

Non Dimmable
 03.6055.B1
 03.6055.14
 03.6055.18
 Mains Dimming
 03.5955.B1
 03.5955.14
 03.5955.18
 Dali/Push Version
 03.6055.B1.DA
 03.6055.14.DA
 03.6055.18.DA

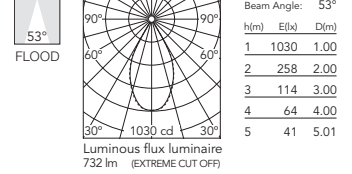

Non Dimmable
 03.6052.B1
 03.6052.14
 03.6052.18
 Mains Dimming
 03.5952.B1
 03.5952.14
 03.5952.18
 Dali/Push Version
 03.6052.B1.DA
 03.6052.14.DA
 03.6052.18.DA

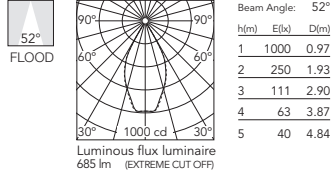

Non Dimmable
 03.6056.B1
 03.6056.14
 03.6056.18
 Mains Dimming
 03.5956.B1
 03.5956.14
 03.5956.18
 Dali/Push Version
 03.6056.B1.DA
 03.6056.14.DA
 03.6056.18.DA

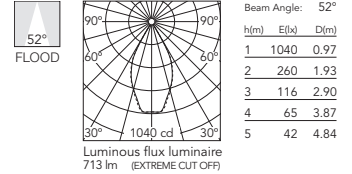

Non Dimmable
 03.6053.B1
 03.6053.14
 03.6053.18
 Mains Dimming
 03.5953.B1
 03.5953.14
 03.5953.18
 Dali/Push Version
 03.6053.B1.DA
 03.6053.14.DA
 03.6053.18.DA

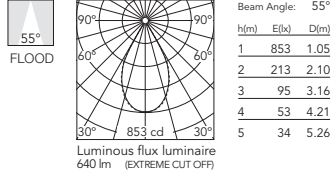

Non Dimmable
 03.6057.B1
 03.6057.14
 03.6057.18
 Mains Dimming
 03.5957.B1
 03.5957.14
 03.5957.18
 Dali/Push Version
 03.6057.B1.DA
 03.6057.14.DA
 03.6057.18.DA

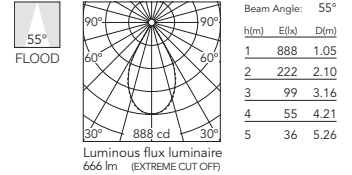

KAP SURFACE

Kap Surface Ceiling

Light Source: Power LED 9W - 1000 lm - 3000K/CRI 80

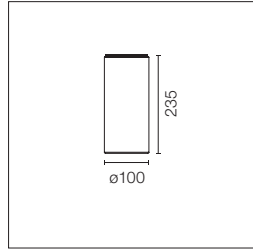

LED Einbauleuchte. Lieferung mit nicht regulierbarem Netzgerät mit 110/240V - 50/60Hz im Leuchtenkörper.

Luminaire for mounting on the ceiling with LED light source. Non-adjustable 110/240V - 50/60Hz power supply integrated into luminaire body.

E= Außenfarbe
I= Innenfarbe

E= External Finish
I= Internal Finish

E	I	Code
White	White	03.4520.11B
White	Black	03.4520.ASB
White	Blue	03.4520.ANB
White	Black	03.4520.B3B

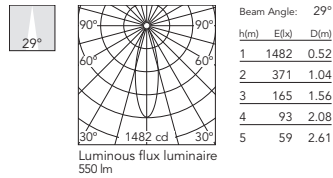

E	I	Code
White	White	03.4521.11B
White	Black	03.4521.ASB
White	Blue	03.4521.ANB
White	Black	03.4521.B3B

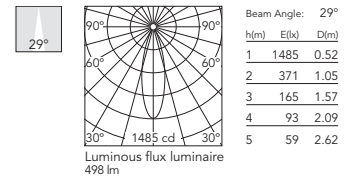

E	I	Code
White	White	03.4522.11B
White	Black	03.4522.ASB
White	Blue	03.4522.ANB
White	Black	03.4522.B3B

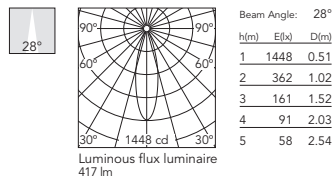

E	I	Code
White	White	03.4523.11B
White	Black	03.4523.ASB
White	Blue	03.4523.ANB
White	Black	03.4523.B3B

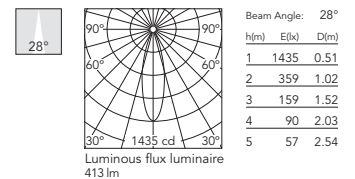

Kap Surface Wall

Light Source: Power LED 9W - 1000 lm - 3000K/CRI 80

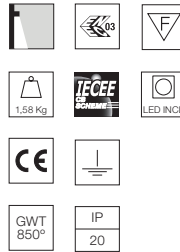
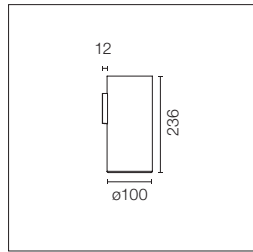

LED Wandleuchte. Lieferung mit nicht regulierbarem Netzgerät mit 110/240V - 50/60Hz im Gerätekörper.

Luminaire for wall mounting with LED light source. Non-adjustable 110/240V - 50/60Hz power supply integrated into luminaire body.

E= Außenfarbe
I= Innenfarbe

E= External Finish
I= Internal Finish

E	I	Code
White	White	03.5730.11B
White	Black	03.5730.ASB
White	Blue	03.5730.ANB
White	Black	03.5730.B3B

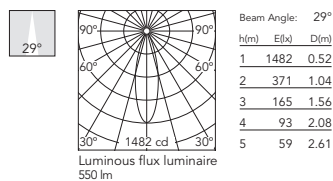

E	I	Code
White	White	03.5731.11B
White	Black	03.5731.ASB
White	Blue	03.5731.ANB
White	Black	03.5731.B3B

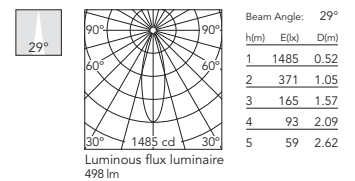

E	I	Code
White	White	03.5732.11B
White	Black	03.5732.ASB
White	Blue	03.5732.ANB
White	Black	03.5732.B3B

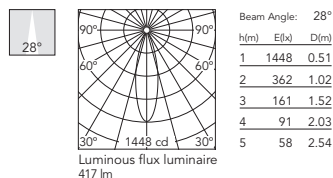

E	I	Code
White	White	03.5733.11B
White	Black	03.5733.ASB
White	Blue	03.5733.ANB
White	Black	03.5733.B3B

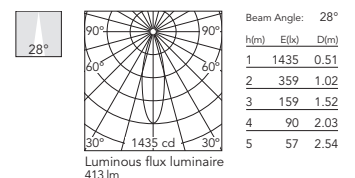

KAP SUSPENSION

Kap Suspension

Light Source: Power LED 9W - 1000 lm - 3000K/CRI 80

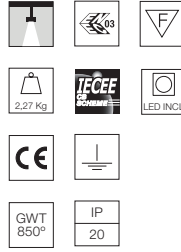
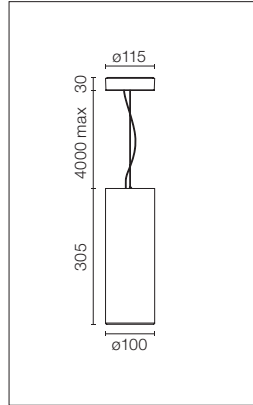

LED Aufbau-Pendelleuchte.
Lieferung mit nicht regulierbarem
Netzgerät mit 110/240V - 50/60Hz
im Leuchtenkörper.

E= Außenfarbe
I= Innenfarbe

Suspended ceiling-mounted
luminaire with LED light source.
Non-adjustable 110/240V - 50/60Hz
power supply integrated into
luminaire body.

E= External Finish
I= Internal Finish

E	I	
White	White	03.5810.11B
White	Black	03.5810.ASB
White	Grey	03.5810.ANB
Black	White	03.5810.B3B

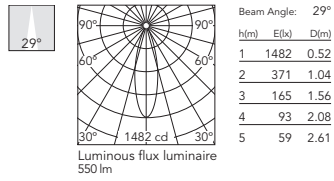

E	I	
White	White	03.5811.11B
White	Black	03.5811.ASB
White	Grey	03.5811.ANB
Black	White	03.5811.B3B

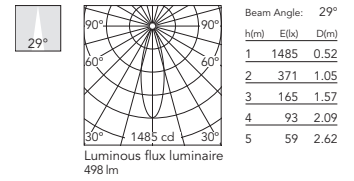

E	I	
White	White	03.5812.11B
White	Black	03.5812.ASB
White	Grey	03.5812.ANB
Black	White	03.5812.B3B

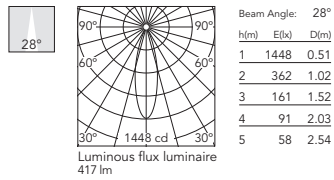

E	I	
White	White	03.5813.11B
White	Black	03.5813.ASB
White	Grey	03.5813.ANB
Black	White	03.5813.B3B

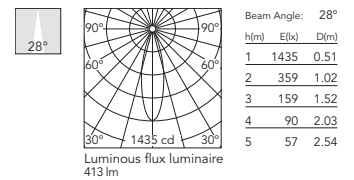

COMPASS BOX

DESIGNED BY FLOS ARCHITECTURAL

SMALL
1L / 2L / 4L /
4L SQUARE



LIGHT SOURCE
LED ARRAY
6,2W
860 lm
3000K/CRI 80

SMALL
1L / 2L / 4L



LIGHT SOURCE
LED
QR-CBC 51
GX5.3

LARGE H:135
1L / 2L / 4L /
4L SQUARE



LIGHT SOURCE
LED
QR-111
G53

□ 30 Mattweiss/RAL 9001
30 Matt White



■ 14 Mattschwarz/RAL 9005
14 Matt Black



▒ 29 Eloxiertes Aluminium
29 Anodized Aluminium



■ WG Wenge
WG Wenge



■ TK Teak-Holz
TK Teak



Schwenkbar um 20°.
Can be swivelled 20°.

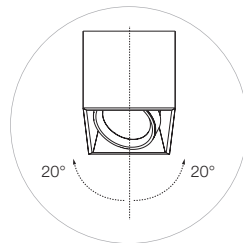

COMPASS BOX

Produktbeschreibung

Beleuchtungssystem mit einer, zwei und vier einstellbaren Leuchten für die Installation an Wand oder Decke. Geeignet für LED-Lichtquellen. Optikgehäuse aus schwarz lackiertem Pressstahl und äußere Struktur aus Aluminiumguss mit Befestigungssystem. Elektronischer Transformator und Anschlussklemme in der Leuchte eingebaut.

Betriebsgerät

LED:
- Inklusive nicht regulierbares Netzgerät: 220/240V - 50/60Hz Konstantstrom mit 350 mA.
Für LED retrofit Versionen:
- Elektronischer Transformator 20/105W - 230/240V, 50/60Hz mit Lichtstärkenverstellung mittels "leading and trailing edge" System (Phasen- und Phasenabschnittdimmer).

Zubehör

- Eingebauter Abschirmzylinder mit drehbarem Stift aus schwarzem Thermoplastik.
- Honeycomb.

Zusatzinformationen

In zwei Höhen lieferbar.
Das Ausrichtungssystem erlaubt die Drehung um 40° in allen Richtungen.
Schutzgrad IP20.
Schutzklasse I, II je nach Modell.
Auf normal entflammaren Oberflächen einsetzbar.

Qualitätszeichen

Das Gerät entspricht der europäischen technischen Norm EN60598-1 und den entsprechenden Zusatzregelungen.

Description

Wall or ceiling luminaires with 1, 2 or 4 adjustable lights. Suitable for LED light sources. Pressed steel, black-painted optical body and extruded-aluminum outer structure with fixing system. Electrical connection and control devices incorporated in the luminaire.

Power Supply

LED:
- Built-in, non-regulable constant current power supply of 220/240V, 50/60Hz. 350 mA current.
For LED retrofit versions:
- Electronic transformer of 20/105W – 220/240V - 50/60Hz with intensity regulation through "leading and trailing edge" device.

Accessories

- Screening cylinder and black thermoplastic rotating pin.
- Honeycomb.

Additional Information

Two heights.
0-20° adjustment in all directions.
IP20 protection grade.
Insulation class I, II depending on the versions.
Suitable for installation on normally inflammable surfaces.

Standard Compliance and Quality Marks

EN60598-1 European Technical Standards and any subsequent additions.



COMPASS BOX

Compass Box Small 1L

Light Source: LED Array 6,2W - 860 lm - 3000K/CRI 80

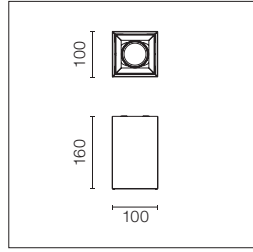

Aufbaustrahler zur Decken/
Wandbefestigung mit LED-Lampe.
Lieferung mit nicht regulierbarem
Netzgerät mit 220-240 V, 50-60 Hz
im Gerätekörper.

Surface spotlight to be installed on
ceiling/wall with LED light source.
Non-regulable 220-240V, 50-60Hz
power supply integrated in luminaire
body.

- 03.2630.30A
- 03.2630.29A
- 03.2630.14A
- 03.2630.WGA
- 03.2630.TKA

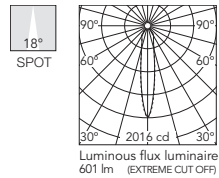

h(m)	E(lx)	D(m)
1	2016	0.31
2	504	0.62
3	224	0.93
4	126	1.23
5	81	1.54

- 03.2632.30A
- 03.2632.29A
- 03.2632.14A
- 03.2632.WGA
- 03.2632.TKA

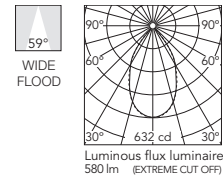

h(m)	E(lx)	D(m)
1	632	1.14
2	158	2.28
3	70	3.42
4	39	4.56
5	25	5.70

- 03.2631.30A
- 03.2631.29A
- 03.2631.14A
- 03.2631.WGA
- 03.2631.TKA

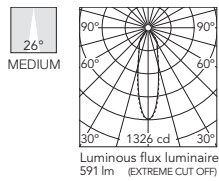

h(m)	E(lx)	D(m)
1	1326	0.47
2	332	0.93
3	147	1.40
4	83	1.87
5	53	2.34

Compass Box Small 2L

Light Source: LED Array 2x6,2W - 2x860 lm - 3000K/CRI 80

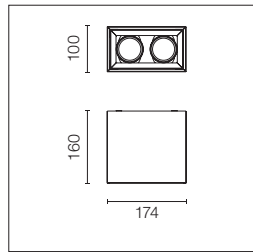

Aufbaustrahler zur Decken/
Wandbefestigung mit LED-Lampe.
Lieferung mit nicht regulierbarem
Netzgerät mit 220-240 V, 50-60 Hz
im Gerätekörper.

Surface spotlight to be installed on
ceiling/wall with LED light source.
Non-regulable 220-240V, 50-60Hz
power supply integrated in luminaire
body.

- 03.2635.30A
- 03.2635.29A
- 03.2635.14A
- 03.2635.WGA
- 03.2635.TKA

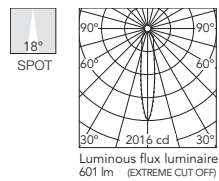

h(m)	E(lx)	D(m)
1	2016	0.31
2	504	0.62
3	224	0.93
4	126	1.23
5	81	1.54

- 03.2637.30A
- 03.2637.29A
- 03.2637.14A
- 03.2637.WGA
- 03.2637.TKA

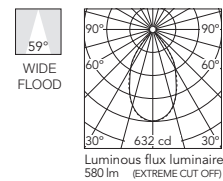

h(m)	E(lx)	D(m)
1	632	1.14
2	158	2.28
3	70	3.42
4	39	4.56
5	25	5.70

- 03.2636.30A
- 03.2636.29A
- 03.2636.14A
- 03.2636.WGA
- 03.2636.TKA

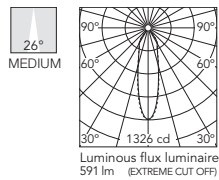

h(m)	E(lx)	D(m)
1	1326	0.47
2	332	0.93
3	147	1.40
4	83	1.87
5	53	2.34

COMPASS BOX

Compass Box Small 4L

Light Source: LED Array 4x6,2W - 4x860 lm - 3000K/CRI 80

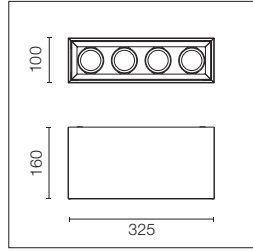

Aufbaustrahler zur Decken/
Wandbefestigung mit LED-Lampe.
Lieferung mit nicht regulierbarem
Netzgerät mit 220-240 V, 50-60 Hz
im Gerätekörper.

Surface spotlight to be installed on
ceiling/wall with LED light source.
Non-regulable 220-240V, 50-60Hz
power supply integrated in luminaire
body.

- 03.2640.30A
- 03.2640.29A
- 03.2640.14A
- 03.2640.WGA
- 03.2640.TKA

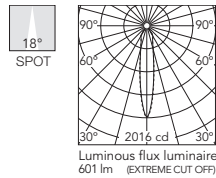

Beam Angle: 18°

h(m)	E(lx)	D(m)
1	2016	0.31
2	504	0.62
3	224	0.93
4	126	1.23
5	81	1.54

- 03.2642.30A
- 03.2642.29A
- 03.2642.14A
- 03.2642.WGA
- 03.2642.TKA

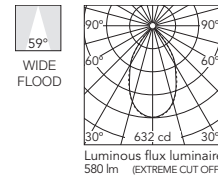

Beam Angle: 59°

h(m)	E(lx)	D(m)
1	632	1.14
2	158	2.28
3	70	3.42
4	39	4.56
5	25	5.70

- 03.2641.30A
- 03.2641.29A
- 03.2641.14A
- 03.2641.WGA
- 03.2641.TKA

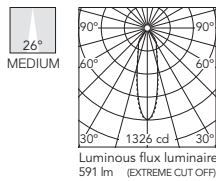

Beam Angle: 26°

h(m)	E(lx)	D(m)
1	1326	0.47
2	332	0.93
3	147	1.40
4	83	1.87
5	53	2.34

Compass Box Small 4L Square

Light Source: LED Array 4x6,2W - 4x860 lm - 3000K/CRI 80

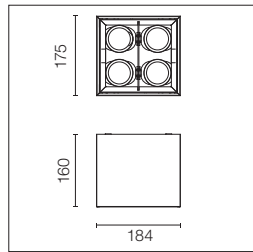

Aufbaustrahler zur Decken/
Wandbefestigung mit LED-Lampe.
Lieferung mit nicht regulierbarem
Netzgerät mit 220-240 V, 50-60 Hz
im Gerätekörper.

Surface spotlight to be installed on
ceiling/wall with LED light source.
Non-regulable 220-240V, 50-60Hz
power supply integrated in luminaire
body.

- 03.2645.30A
- 03.2645.29A
- 03.2645.14A
- 03.2645.WGA
- 03.2645.TKA

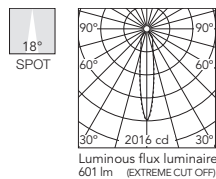

Beam Angle: 18°

h(m)	E(lx)	D(m)
1	2016	0.31
2	504	0.62
3	224	0.93
4	126	1.23
5	81	1.54

- 03.2647.30A
- 03.2647.29A
- 03.2647.14A
- 03.2647.WGA
- 03.2647.TKA

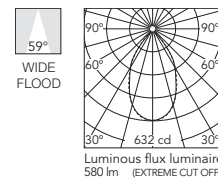

Beam Angle: 59°

h(m)	E(lx)	D(m)
1	632	1.14
2	158	2.28
3	70	3.42
4	39	4.56
5	25	5.70

- 03.2646.30A
- 03.2646.29A
- 03.2646.14A
- 03.2646.WGA
- 03.2646.TKA

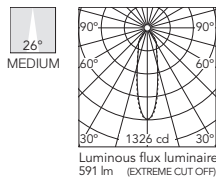

Beam Angle: 26°

h(m)	E(lx)	D(m)
1	1326	0.47
2	332	0.93
3	147	1.40
4	83	1.87
5	53	2.34

COMPASS BOX

Compass Box Small 1L

Light Source: LED QR-CBC 51 GX5.3

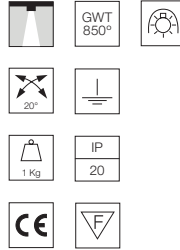
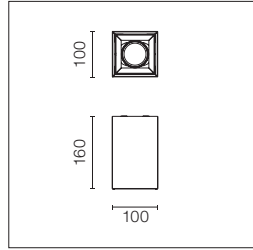

Aufbaustrahler zur Decken/Wandbefestigung. Integrierter elektronischer Transformator 220/240V – 12V, 50/60Hz. Helligkeitsregelung über "Leading and Trailing Edge"-Dimmer bei kompatiblen Lampen.

Surface spotlight to be installed on ceiling/wall. Electronic transformer integrated 220/240V – 12V, 50/60Hz. The intensity of the lighting may be adjusted via leading and trail edge modulation in compatible lamps.

- 03.2600.30
- 03.2600.29
- 03.2600.14
- 03.2600.WG
- 03.2600.TK

Compass Box Small 2L

Light Source: LED QR-CBC 51 GX5.3

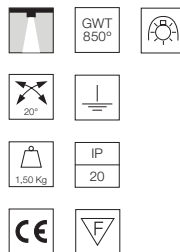
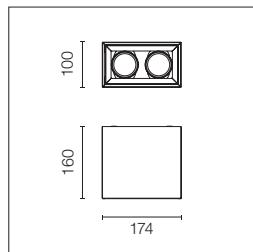

Aufbaustrahler zur Decken/Wandbefestigung. Integrierter elektronischer Transformator 220/240V – 12V, 50/60Hz. Helligkeitsregelung über "Leading and Trailing Edge"-Dimmer bei kompatiblen Lampen.

Surface spotlight to be installed on ceiling/wall. Electronic transformer integrated 220/240V – 12V, 50/60Hz. The intensity of the lighting may be adjusted via leading and trail edge modulation in compatible lamps.

- 03.2601.30
- 03.2601.29
- 03.2601.14
- 03.2601.WG
- 03.2601.TK

Compass Box Small 4L

Light Source: LED QR-CBC 51 GX5.3

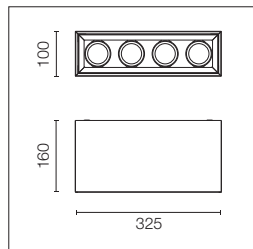

Aufbaustrahler zur Decken/Wandbefestigung. Integrierter elektronischer Transformator 220/240V – 12V, 50/60Hz. Helligkeitsregelung über "Leading and Trailing Edge"-Dimmer bei kompatiblen Lampen.

Surface spotlight to be installed on ceiling/wall. Electronic transformer integrated 220/240V – 12V, 50/60Hz. The intensity of the lighting may be adjusted via leading and trail edge modulation in compatible lamps.

- 03.2603.30
- 03.2603.29
- 03.2603.14
- 03.2603.WG
- 03.2603.TK

Compass Box Large 1L H:135

Light Source: LED QR-111 G53

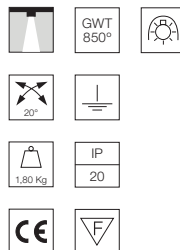
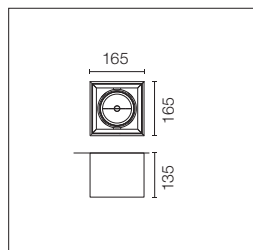

Aufbaustrahler zur Decken/Wandbefestigung. Integrierter elektronischer Transformator 220/240V – 12V, 50/60Hz. Helligkeitsregelung über "Leading and Trailing Edge"-Dimmer bei kompatiblen Lampen.

Surface spotlight to be installed on ceiling/wall. Electronic transformer integrated 220/240V – 12V, 50/60Hz. The intensity of the lighting may be adjusted via leading and trail edge modulation in compatible lamps.

- 03.1060.30
- 03.1060.29
- 03.1060.14
- 03.1060.WG
- 03.1060.TK

COMPASS BOX



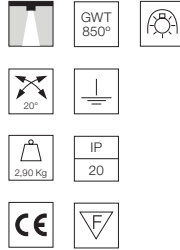
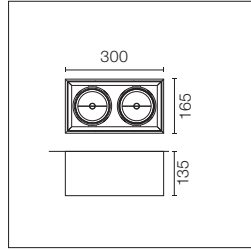

Compass Box Large 2L H:135

Light Source: LED QR-111 G53



Aufbaustrahler zur Decken/
Wandbefestigung. Integrierter
elektronischer Transformator
220/240V – 12V, 50/60Hz.
Helligkeitsregelung über "Leading
and Trailing Edge"-Dimmer bei
kompatiblen Lampen.

Surface spotlight to be installed on
ceiling/wall. Electronic transformer
integrated 220/240V – 12V, 50/60Hz.
The intensity of the lighting may be
adjusted via leading and trail edge
modulation in compatible lamps.

-  03.1061.30
-  03.1061.29
-  03.1061.14
-  03.1061.WG
-  03.1061.TK



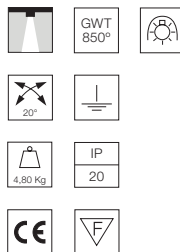
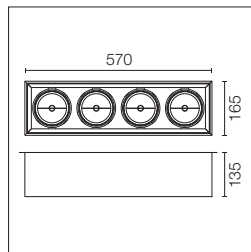

Compass Box Large 4L H:135

Light Source: LED QR-111 G53



Aufbaustrahler zur Decken/
Wandbefestigung. Integrierter
elektronischer Transformator
220/240V – 12V, 50/60Hz.
Helligkeitsregelung über "Leading
and Trailing Edge"-Dimmer bei
kompatiblen Lampen.

Surface spotlight to be installed on
ceiling/wall. Electronic transformer
integrated 220/240V – 12V, 50/60Hz.
The intensity of the lighting may be
adjusted via leading and trail edge
modulation in compatible lamps.

-  03.1063.30
-  03.1063.29
-  03.1063.14
-  03.1063.WG
-  03.1063.TK



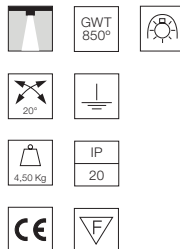
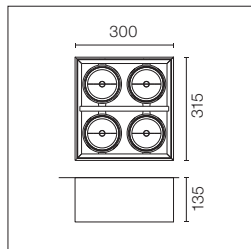

Compass Box Large 4L H:135 Square

Light Source: LED QR-111 G53



Aufbaustrahler zur Decken/
Wandbefestigung. Integrierter
elektronischer Transformator
220/240V – 12V, 50/60Hz.
Helligkeitsregelung über "Leading
and Trailing Edge"-Dimmer bei
kompatiblen Lampen.

Surface spotlight to be installed on
ceiling/wall. Electronic transformer
integrated 220/240V – 12V, 50/60Hz.
The intensity of the lighting may be
adjusted via leading and trail edge
modulation in compatible lamps.

-  03.1064.30
-  03.1064.29
-  03.1064.14
-  03.1064.WG
-  03.1064.TK

Zubehör / Accessories

Compass Box Small: QR-CBC 51

Querabschirmung
Screening crosspiece



08.8238.14

Honeycomb
Honeycomb



08.8196.14

Compass Box Large: QR-111

Querabschirmung
Screening crosspiece



08.8034.14

Honeycomb
Honeycomb



08.8036.14

SUPER LINE&PRO

DESIGNED BY FLOS ARCHITECTURAL

**SUPER LINE
UP&DOWN
INDIRECT**



LIGHT SOURCE
TOP LED
58W
4488 lm UP
2160 lm DOWN
3000K/CRI 90

4794 lm UP
2280 lm DOWN
4000K/CRI 90

**SUPER LINE
UP&DOWN
DIRECT**



LIGHT SOURCE
TOP LED
58W
2268 lm UP
4488 lm DOWN
3000K/CRI 90

2376 lm UP
4794 lm DOWN
4000K/CRI 90

**SUPER LINE
DOWN**



LIGHT SOURCE
TOP LED
38,6W
4488 lm
3000K/CRI 90
4794 lm
4000K/CRI 90

**SUPER LINE PRO
UP&DOWN**



LIGHT SOURCE
TOP LED
60W
UP TO 4075 lm UP
UP TO 4605 lm DOWN
3000K/CRI 90

UP TO 4337 lm UP
UP TO 4900 lm DOWN
4000K/CRI 90

**SUPER LINE PRO
DOWN**



LIGHT SOURCE
TOP LED
40W
UP TO 5072 lm
3000K/CRI 90
UP TO 4765 lm
4000K/CRI 90

□ 40 Weiss
40 White

■ 02 Grau
02 Grey

■ 14 Schwarz
14 Black

■ ET Gebürstetes Messing
ET Brushed Brass

■ EU Gebürstetes Roségold
EU Brushed Rose Gold

Super Line

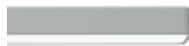
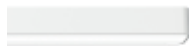

Super Line Pro



Super Line



Super Line Pro



Produktbeschreibung

Eine Kollektion von Hängeleuchten mit charakteristischer minimalistischer Form für die allgemeine Beleuchtung; konzipiert für Hochleistungsbeleuchtung, höchste Lichtqualität und Sehkomfort in Kombination mit einer sehr kompakten Größe.

Die Super Line Pro-Version wurde entwickelt, um alle Anforderungen zu erfüllen, damit die Blendung reduziert und der Sehkomfort in Büroräumen verbessert wird. Dabei wurden die strengsten Bedingungen eingehalten. Ein UGR von weniger als 14 und ein maximaler Intensitätswert von weniger als 3000 cd/m² in einem Winkel von 65° gemäß der Norm, garantieren die besten Bedingungen für Arbeitsplätze und machen das Produkt perfekt für viele andere Anwendungen. (Siehe Tabelle UGR unter dem Kapitel Zubehör).

Der Hauptteil der Lichtquellen ist aus extrudiertem Aluminium hergestellt. Die Super Line ist mit einem technisch mehrschichtigen Verteilerfilter ausgestattet, was dank seiner Kombination der prismatischen und elyptischen Filter das Licht perfekt verteilt, die optische Wirkung und den Sichtkomfort mittels Gegenblendung bessert.

Super Line Up & Down sind in zwei Versionen verfügbar:

- Indirect Version: die indirekte Beleuchtung nach oben mit einer helleren Leuchtintensität privilegiert und das beleuchtete Umfeld homogenisiert; sie bietet ein UGR<19 und ist die ideale Beleuchtung für Büros.
- Direct Version: die direkte Beleuchtung privilegiert und die Wirkung maximiert, jedoch gleichzeitig den "Effekt Höhle" mit seiner indirekten Intensität vorbeugt und einen ausgezeichneten Komfort garantiert.

Super Line Pro Up&Down gibt es nur in einer Version, die mit dem entsprechenden Treiber personalisiert werden kann, um einen höheren Fluss im oberen oder unteren Teil zu bieten.

Um die visuelle Wirkung der Kollektion zu minimieren, sind die Hängekabel der Leiter des Stroms, wodurch der Stromschlauch beseitigt wird. Die Aufhängungslänge beträgt 4,25 m.

Einbauanleitung

Die Super Line verbindet ein ausgewähltes Lichtquellenmodul mit einem von drei verfügbaren Montagekits:

- Oberflächen-Kit: enthält Aufputzdose einschließlich des Netzgerät-treibers.
- Integriertes-Kit: enthält bündig eingebaute Dose einschließlich des Netzgerät-treibers
- Externes Netzgerät-Kit: enthält ein Zubehörteil als Kabelschutz sowie ein Netzgerät für eine extern zugängliche Installation.

Super Line Pro verwendet die gleichen Netzteile. Bei der Up & Down-Version verfügen die Stromquellen über zwei Ausgänge für die Leuchte mit jeweils einer Ampere-Zahl (mA). Durch Verbinden jedes dieser Ausgänge mit einem Eingang der Leuchte (Up oder Down) kann für jedes Teil ein höherer oder niedrigerer Fluss gewählt werden.

Die nicht-dimmbaren Versionen sind mit einem Mehrfachtreiber ausgestattet, der bei der Installation eingestellt werden kann, um die gewünschten Beleuchtungsverhältnisse zu erreichen.

Die Super-Line-Installationskits verlassen die Fabrik mit 100 % ihrer Nennleistung.

Alle Leuchten verfügen über eine hochempfindliche Dosenlibelle, die die Installation der Leuchte vereinfacht und die Kalibrierung auf beiden Achsen kontrolliert.

Zusatzinformationen

Schutzklasse I.
Schutzgrad IP20.

Qualitätszeichen

Das Gerät entspricht der europäischen technischen Norm EN60598-1 und den entsprechenden Zusatzregelungen.

Description

Collection of suspended luminaires for general lighting with a signature minimalist shape, designed to offer high-performance lighting, light quality and visual comfort combined in a very compact size.

The Super Line Pro version was designed to meet all requirements to reduce glare and improve visual comfort in offices, complying with the most restrictive conditions. A UGR less than 14 and a maximum intensity value less than 3000 cd/m² at an angle of 65° according to the standard, guarantee the best conditions for workplaces and make it perfect for many other applications. (Refer to the UGR chart in the accessories section).

The main body of the lights is made from extruded aluminium. Super Line is equipped with a multilayer diffusion filter which, thanks to its combination of elliptical and prism-shaped filters, ensures that the light is perfectly distributed and improves the overall visual effect, as well as providing comfort with its anti-glare properties.

Super Line Up&Down is available in two different versions:

- Indirect: a version which is better for emitting light indirectly upwards, with a greater intensity of indirect luminosity that homogenizes the lighting area, designed to provide UGR<19 and the perfect lighting conditions for offices.
- Direct: a version which is better for direct lighting and maximises efficiency, but at the same time prevents any "cave effect" with its indirect intensity, guaranteeing a high level of comfort.

Super Line Pro Up&Down comes in only one version that can be adjusted using the corresponding driver to offer a higher flux in the upper or lower part.

To minimise the visual impact of the collection, the suspension cables are also the wires, which eliminates the need for a power supply cable. Suspension length: 4.25 meters.

Installation Information

The Super Line is constructed combining the selected light source module with one of the three existing installation kits:

- Surface Kit: includes surface mounted box including the power supply driver.
- Integrated Kit: includes flush-recessed installation box, including power supply driver.
- Remote Power Supply Kit: includes an accessory as pass-through cable protection as well as a power supply driver for a remote accessible installation.

All installation kits are available either in DALI version or in a non dimmable version.

Super Line Pro uses the same power kits. For the Up&Down version, the power sources have two outputs to the light fitting, each with an amount of current (mA). By connecting each of these outputs to an input of the light fitting (Up or Down), a higher or lower flux can be chosen for each part.

The non dimmable versions are equipped with a multi-current driver that can be set during the installation in order to achieve the required illumination conditions. The Super Line installation kits come from factory at 100% of their nominal power.

All luminaires host a high-precision circular level, simplifying the installation of the luminaire, controlling calibration in both axes.

Additional Information

Insulation class I.
IP20 protection grade.

Standard Compliance and Quality Marks

EN60598-1 European Technical Standards and any subsequent additions.

Super Line Up&Down Indirect

Light Source: Top LED 58W - 4488 lm UP - 2160 lm DOWN - 3000K/CRI 90 / 58W - 4794 lm UP - 2280 lm DOWN - 4000K/CRI 90

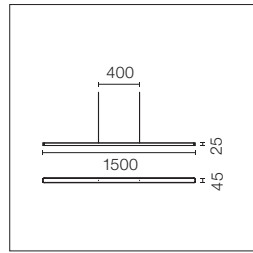

1.45 Kg

850°
 20

LED Leuchte für direkte oder indirekte Grundbeleuchtung mit einem unverwechselbar minimalistischen und kompakten Design, für die Installation als Hängeleuchte. Stromversorgung in den verschiedenen Einbausystemen inklusive, separat zu bestellen.

LED luminaire for direct and indirect lighting with a signature minimalist and compact design, to be installed on ceilings by means of suspension. Power source included in installation kits must be ordered separately.

- 3000K**
- 03.9502.40
 - 03.9502.02
 - 03.9502.14
 - 03.9502.ET
 - 03.9502.EU

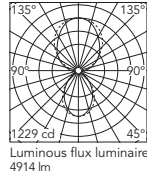

Beam Angle DIR: 101°

h(m)	Ef(x)	D(m)
1	1229	2.39
2	307	4.78
3	137	7.17
4	77	9.57
5	49	11.96

Luminous flux luminaire 4914 lm

- 4000K**
- 03.9503.40
 - 03.9503.02
 - 03.9503.14
 - 03.9503.ET
 - 03.9503.EU

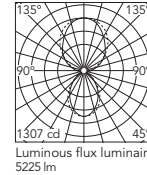

Beam Angle DIR: 101°

h(m)	Ef(x)	D(m)
1	1307	2.39
2	327	4.78
3	145	7.17
4	82	9.57
5	52	11.96

Luminous flux luminaire 5225 lm

Super Line Up&Down Direct

Light Source: Top LED 58W - 2268 lm UP - 4488 lm DOWN - 3000K/CRI 90 / 58W - 2376 lm UP - 4794 lm DOWN - 4000K/CRI 90

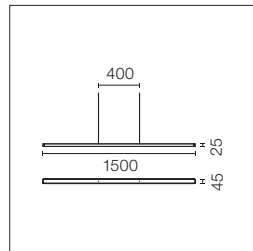

1.45 Kg

850°
 20

LED Leuchte für direkte oder indirekte Grundbeleuchtung mit einem unverwechselbar minimalistischen und kompakten Design, für die Installation als Hängeleuchte. Stromversorgung in den verschiedenen Einbausystemen inklusive, separat zu bestellen.

LED luminaire for direct and indirect lighting with a signature minimalist and compact design, to be installed on ceilings by means of suspension. Power source included in installation kits must be ordered separately.

- 3000K**
- 03.9500.40
 - 03.9500.02
 - 03.9500.14
 - 03.9500.ET
 - 03.9500.EU

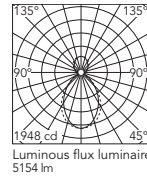

Beam Angle DIR: 82°

h(m)	Ef(x)	D(m)
1	1948	1.57
2	487	3.13
3	216	4.70
4	122	6.27
5	78	7.84

Luminous flux luminaire 5154 lm

- 4000K**
- 03.9501.40
 - 03.9501.02
 - 03.9501.14
 - 03.9501.ET
 - 03.9501.EU

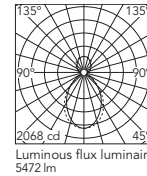

Beam Angle DIR: 82°

h(m)	Ef(x)	D(m)
1	2068	1.57
2	517	3.13
3	230	4.70
4	129	6.27
5	83	7.84

Luminous flux luminaire 5472 lm

Super Line Down

Light Source: Top LED 38,5W - 4488 lm - 3000K/CRI 90 / 38,5W- 4794 lm - 4000K/CRI 90

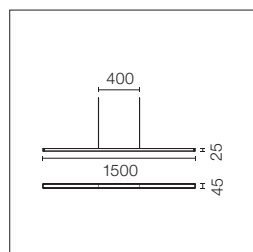

1.45 Kg

850°
 20

LED Leuchte zur Grundbeleuchtung mit einem unverwechselbar minimalistischen und kompakten Design, für die Installation als Hängeleuchte. Stromversorgung in den verschiedenen Einbausystemen inklusive, separat zu bestellen.

LED luminaire for general lighting with a signature minimalist and compact design, to be installed on ceilings by means of suspension. Power source included in installation kits must be ordered separately.

- 3000K**
- 03.9510.40
 - 03.9510.02
 - 03.9510.14
 - 03.9510.ET
 - 03.9510.EU

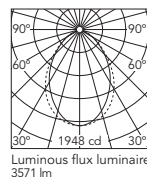

Beam Angle: 82°

h(m)	Ef(x)	D(m)
1	1948	1.57
2	487	3.13
3	216	4.70
4	122	6.27
5	78	7.84

Luminous flux luminaire 3571 lm

- 4000K**
- 03.9511.40
 - 03.9511.02
 - 03.9511.14
 - 03.9511.ET
 - 03.9511.EU

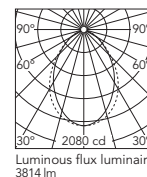

Beam Angle: 82°

h(m)	Ef(x)	D(m)
1	2080	1.57
2	520	3.13
3	231	4.70
4	130	6.27
5	83	7.84

Luminous flux luminaire 3814 lm

Super Line Pro Up&Down

Light Source: Majority UP - Top LED 60W - 4075 lm UP - 2500 lm DOWN - 3000K/CRI 90 / 60W - 4335 lm UP - 2660 lm DOWN - 4000K/CRI 90
Majority DOWN - Top LED 60W - 2590 lm UP - 4605 lm DOWN - 3000K/CRI 90 / 60W - 2755 lm UP - 4900 lm DOWN - 4000K/CRI 90

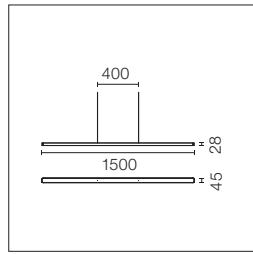

1,45 Kg

 850°
 20

LED Leuchte für direkte oder indirekte Grundbeleuchtung mit einem unverwechselbar minimalistischen und kompakten Design, für die Installation als Hängeleuchte. Stromversorgung in den verschiedenen Einbausystemen inklusive, separat zu bestellen. Die Auswahl der Einheit mit der höchsten Intensität Up oder Down erfolgt in den Einspeisungssets, die über eine Vorrichtung mit zwei unabhängigen Ausgängen verfügen.

LED luminaire for direct and indirect lighting with a signature minimalist and compact design, to be installed on ceilings by means of suspension. Power source included in installation kits must be ordered separately. Greater Up or Down intensity can be selected using power kits with a device with two independent outputs.

- 3000K**
- 03.9560.40
 - 03.9560.02
 - 03.9560.14
 - 03.9560.ET
 - 03.9560.EU

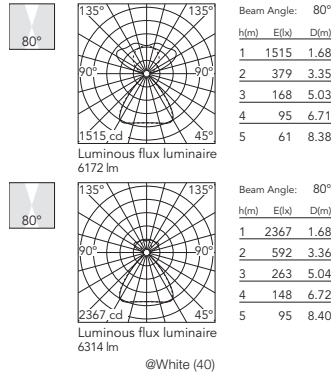

- 4000K**
- 03.9561.40
 - 03.9561.02
 - 03.9561.14
 - 03.9561.ET
 - 03.9561.EU

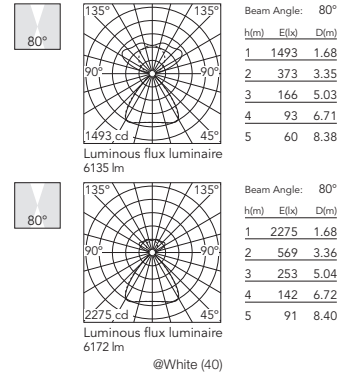

Super Line Pro Down

Light Source: Top LED 40W - 4765 lm - 3000K/CRI 90 / 40W- 5070 lm - 4000K/CRI 90

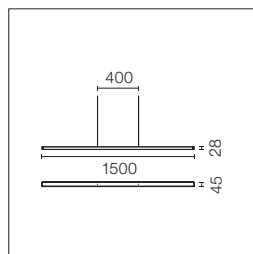

1,45 Kg

 850°
 20

LED Leuchte zur Grundbeleuchtung mit einem unverwechselbar minimalistischen und kompakten Design, für die Installation als Hängeleuchte. Stromversorgung in den verschiedenen Einbausystemen inklusive, separat zu bestellen, wobei die maximale Intensität ausgewählt werden kann.

LED luminaire for general lighting with a signature minimalist and compact design, to be installed on ceilings by means of suspension. Power source included in installation kits must be ordered separately, allowing the maximum brightness to be selected.

- 3000K**
- 03.9570.40
 - 03.9570.02
 - 03.9570.14
 - 03.9570.ET
 - 03.9570.EU

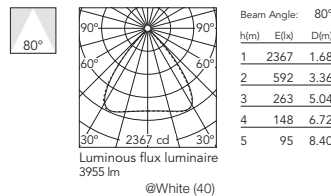

- 4000K**
- 03.9571.40
 - 03.9571.02
 - 03.9571.14
 - 03.9571.ET
 - 03.9571.EU

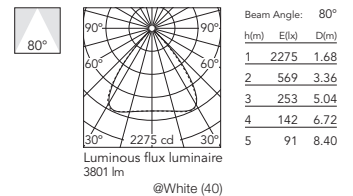

Zubehör / Accessories

Die nicht dimmbaren Versionen von Super Line und Super Line Pro Down verfügen über eine Mehrfachstromversorgung, die während der Installation konfiguriert werden kann, um die gewünschten Beleuchtungsbedingungen und Komfortniveaus zu erzielen. Die Installationskits verlassen die Fabrik mit 100 % ihrer Nennleistung (1050 mA).

Bei maximaler Leistung erfüllen alle Versionen von Super Line Pro die Anforderungen UGR <19 und L 65° <3000 cd.

The non-adjustable versions of Super Line and Super Line Pro Down are equipped with a multi-current driver, that can be set during the installation in order to achieve the required illumination conditions and comfort levels. Installation kits come from factory at 100% of their nominal power (1050 mA).

At maximum power, all versions of Super Line Pro comply with the requirements UGR<19 and L 65°<3000 cd.

Super Line

Driver setting	Light emission	Indirect		Direct	
		UGR*	L 65° < 3000 cd	UGR*	L 65° < 3000 cd
1050 mA	100%	UGR < 19			
850 mA	80%	UGR < 19			
700 mA	70%	UGR < 19			
550 mA	55%	UGR < 19	√		
500 mA	50%	UGR < 19	√	UGR < 19	√
350 mA	36%	UGR < 19	√	UGR < 19	√

*X=4H, Y=8H, S=0.25H, reflections 70/50/20

Super Line Pro

Light emission	UGR*	L 65° < 3000 cd
Up & Down Majority Up	UGR < 14	√
Up & Down Majority Down	UGR < 17	√
Down	UGR < 18	√

Super Line / Super Line Pro Down

Surface Power Supply Kit

60 W – 220/240V-Netzteil
inbegriffen. Die Sets für Super Line und Super Line Pro Down verfügen über einen Treiber mit DIP-Schalter, um die maximale Lichtintensität auszuwählen.

60W – 220/240V power supply included. Kits for Super Line and Super Line Pro Down are equipped with a dip-switch driver to select the maximum intensities.

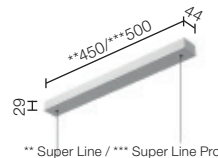

Non Dimmable	
	08.0520.40
	08.0520.02
	08.0520.14
	08.0520.ET
	08.0520.EU
Dali Version*	
	08.0521.40
	08.0521.02
	08.0521.14
	08.0521.ET
	08.0521.EU

Super Line Pro Up&Down

Surface Power Supply Kit

85 W – 220/240V-Netzteil
inbegriffen. Die Sets für Super Line Pro Up&Down verfügen über zwei Ausgänge, um auszuwählen, welcher Teil (Up oder Down) eine größere Intensität hat.

85W – 220/240V power supply included. Kits for Super Line Pro Up&Down are equipped with two outputs to select which part (Up or Down) is brighter.

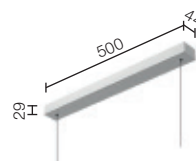

Non Dimmable/Dali Version	
	08.0640.40
	08.0640.02
	08.0640.14
	08.0640.ET
	08.0640.EU

Super Line / Super Line Pro Down

Recessed Power Supply Kit

60 W – 220/240V-Netzteil
inbegriffen. Die Sets für Super Line und Super Line Pro Down verfügen über einen Treiber mit DIP-Schalter, um die maximale Lichtintensität auszuwählen.

60W – 220/240V power supply included. Kits for Super Line and Super Line Pro Down are equipped with a dip-switch driver to select the maximum intensities.

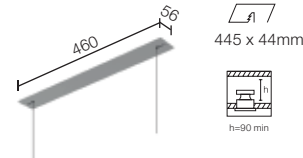

Non Dimmable	
	08.0522.40
	08.0522.02
	08.0522.14
	08.0522.ET
	08.0522.EU
Dali Version*	
	08.0523.40
	08.0523.02
	08.0523.14
	08.0523.ET
	08.0523.EU

Super Line Pro Up&Down

Recessed Power Supply Kit

85 W – 220/240V-Netzteil
inbegriffen. Die Sets für Super Line Pro Up&Down verfügen über zwei Ausgänge, um auszuwählen, welcher Teil (Up oder Down) eine größere Intensität hat.

85W – 220/240V power supply included. Kits for Super Line Pro Up&Down are equipped with two outputs to select which part (Up or Down) is brighter.

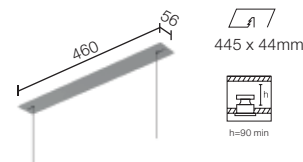

Non Dimmable/Dali Version	
	08.0641.40
	08.0641.02
	08.0641.14
	08.0641.ET
	08.0641.EU

* Für Versionen 1-10V und Push wenden Sie sich an das Front Office / die technische Abteilung / For 1-10V and Push versions, please ask the Front Office/Technical Department.

Zubehör / Accessories

Super Line / Super Line Pro Down

Remote Power Supply Kit

Enthält zwei Aufhängungssätze und ein Netzteil mit 60W - 220 / 240V. Die Sets für Super Line und Super Line Pro Down verfügen über einen Treiber mit DIP-Schalter, um die maximale Lichtintensität auszuwählen.

Includes two suspension kits and a 60W - 220/240V power supply. Kits for Super Line and Super Line Pro Down are equipped with a dip-switch driver to select the maximum intensities.

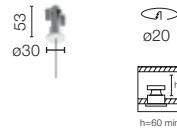

- Non Dimmable
- 08.0524.40
 - 08.0524.02
 - 08.0524.14
 - 08.0524.ET
 - 08.0524.EU
- Dali Version*
- 08.0525.40
 - 08.0525.02
 - 08.0525.14
 - 08.0525.ET
 - 08.0525.EU

Super Line Pro Up&Down

Remote Power Supply Kit

Beinhaltet zwei Aufhängesätze und zwei 45W-Netzteile - 220/240V. Die Sets für Super Line Pro Up&Down verfügen über zwei Ausgänge, um auszuwählen, welcher Teil (Up oder Down) eine größere Intensität hat.

Includes two suspension kits and two 45W - 220/240V power supplies. Kits for Super Line Pro Up&Down are equipped with two outputs to select which part (Up or Down) is brighter.

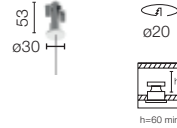

- Non Dimmable/Dali Version
- 08.0642.40
 - 08.0642.02
 - 08.0642.14
 - 08.0642.ET
 - 08.0642.EU

Installation Sequence

Recessed Power Supply Kit

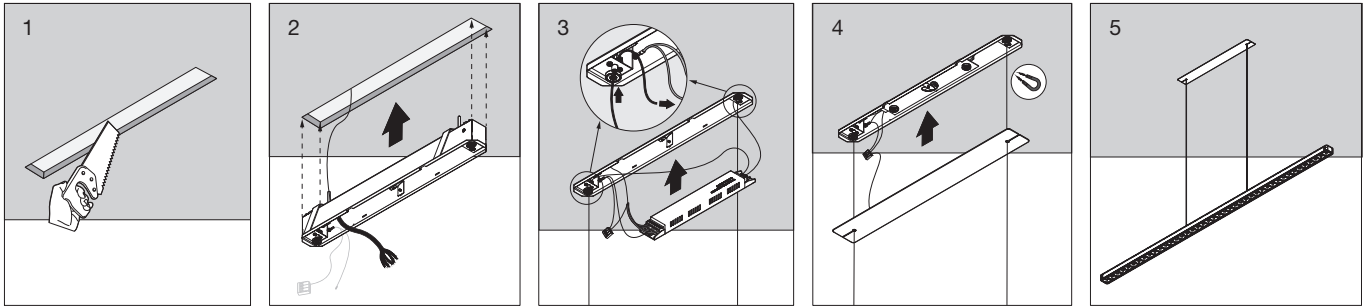

Surface Power Supply Kit

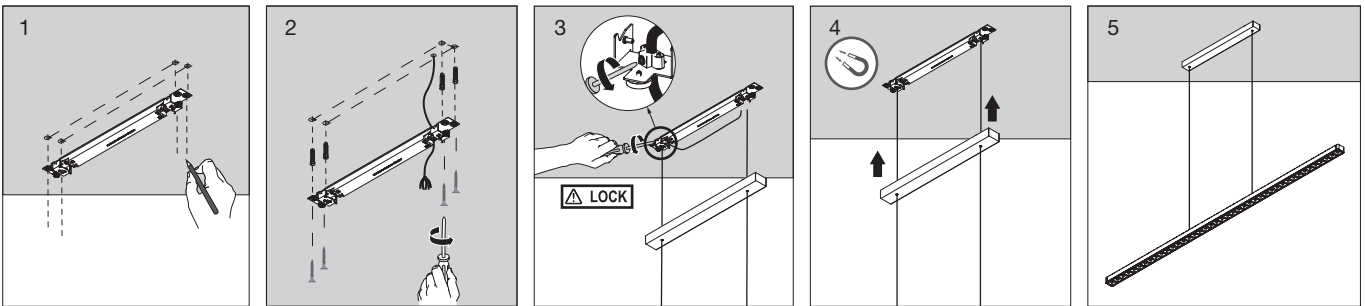

Remote Power Supply Kit

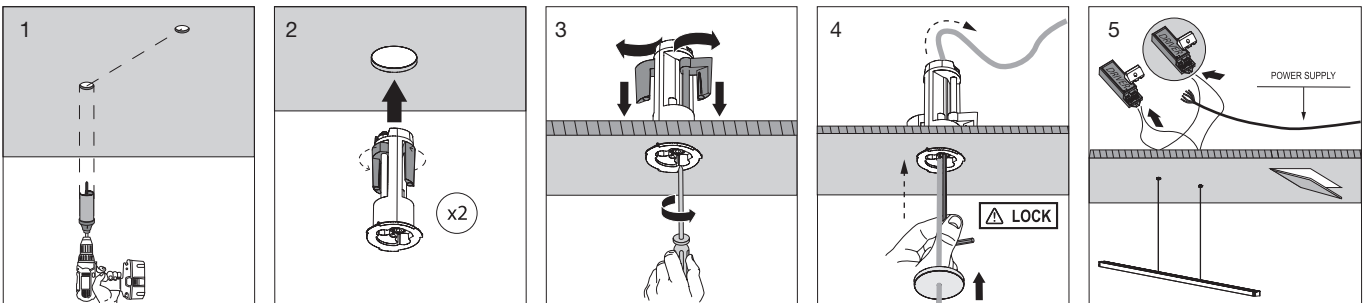

* Für Versionen 1-10V und Push wenden Sie sich an das Front Office / die technische Abteilung / For 1-10V and Push versions, please ask the Front Office/Technical Department.

SUPER FLAT

DESIGNED BY FLOS ARCHITECTURAL

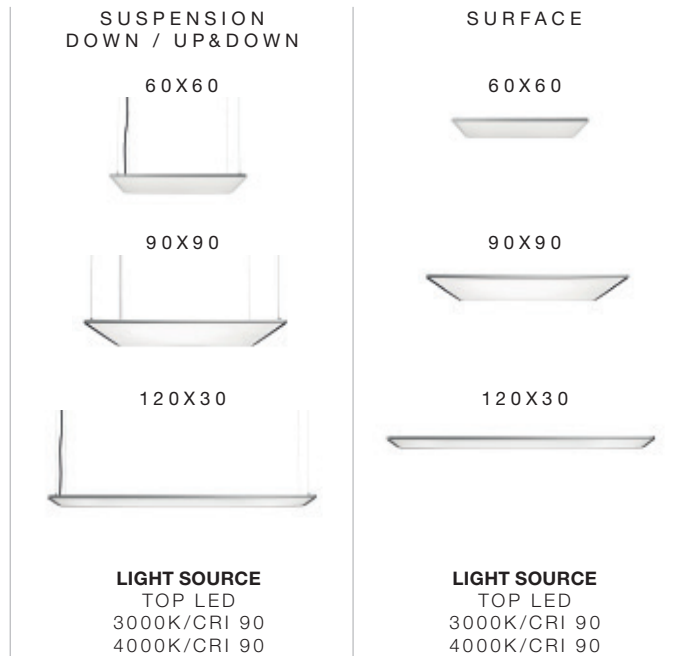

□ 30 Weiss
30 White

■ 02 Grau
02 Grey

■ 14 Schwarz
14 Black



Produktbeschreibung

Leuchtenfamilie für die allgemeine Beleuchtung mit direkter oder indirekter Lichtverteilung. Die Produktfamilie Super Flat bietet unterschiedliche Versionen in quadratischer und rechteckiger Form jeweils aus fließgepresstem Aluminium und Winkeln aus Aluminiumdruckguss. Super Flat verfügt über speziell konzipierte Führungen zur Gewährleistung eines optimalen Lichtstroms und für hohen Sehkomfort. Die Effizienz dieses innovativen Beleuchtungssystems ermöglicht es, Energieverluste auf ein Minimum zu reduzieren. Für höhere Produktvielseitigkeit wurde die ganze Produktfamilie Super Flat als Hänge- und als Aufbauleuchte entwickelt.

Betriebsgerät

Die Leuchte wird mit Konstantstrom-Netzteilen 220/240V geliefert.

Zusatzinformationen

- 30x30-Version:
Schutzklasse II, Schutzgrad IP20.
- 60x60/90x90/120x20/120x30 Versionen:
Schutzklasse I, Schutzgrad IP20.

Qualitätszeichen

Das Gerät entspricht der europäischen technischen Norm EN60598-1 und den entsprechenden Zusatzregelungen.

Description

Family of general lighting luminaires with direct and indirect light distribution. The Super Flat family has several square and rectangular versions, all of which are made of extruded aluminium and with angle brackets made of injected aluminium. Super Flat has some especially designed guides, guaranteeing optimal light flow and great visual comfort. Energy losses are minimised with this efficient and innovative lighting system. The entire Super Flat family has been developed in suspended and surface mounted versions for greater product versatility.

Power Supply

The luminaire is supplied with integrated 220/240 V constant current power supply sources.

Additional Information

- Version 30x30:
Insulation class II, IP20 protection grade.
- Versions 60x60/90x90/120x20/120x30:
Insulation class I, IP20 protection grade.

Standard Compliance and Quality Marks

EN60598-1 European Technical Standards and any subsequent additions.



reddot design award
winner 2013

SUPER FLAT

Super Flat Suspension 60x60 Down

Light Source: Top LED 3000K/CRI 90 / 4000K/CRI 90

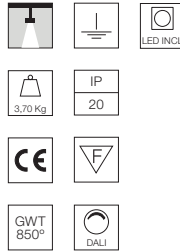
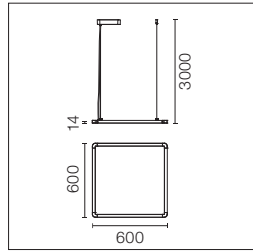

LED-Leuchte für die Allgemeinbeleuchtung. Hängeleuchte für die Deckenmontage. Netzteil 220/240V eingeschlossen.

General lighting LED luminaire to be suspended from ceiling. Power supply 220/240V included.

3000K
Light Source:
Max. 4821 lm.
Lichtausbeute der Leuchte:
Max. 115 lm/W

4000K
Light Source:
Max. 5303 lm.
Lichtausbeute der Leuchte:
Max. 126 lm/W.

3000K
Light Source:
Max. 4821 lm.
Luminous efficiency of luminaire:
Max. 115 lm/W

4000K
Light Source:
Max. 5303 lm.
Luminous efficiency of luminaire:
Max. 126 lm/W.

Gesamtverbrauch des Systems:
40W.

Total consumption of the system:
40W.

- 3000K**
Non Dimmable
- ☐ 09.5010.30B
 - ▒ 09.5010.02B
 - 09.5010.14B
- Dali Version
- ☐ 09.5010.30BDA
 - ▒ 09.5010.02BDA
 - 09.5010.14BDA

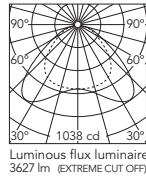

Beam Angle: 109°

h(m)	E lx	D(m)
1	1038	2.81
2	259	5.63
3	115	8.44
4	65	11.25
5	42	14.06

- 4000K**
Non Dimmable
- ☐ 09.5011.30B
 - ▒ 09.5011.02B
 - 09.5011.14B
- Dali Version
- ☐ 09.5011.30BDA
 - ▒ 09.5011.02BDA
 - 09.5011.14BDA

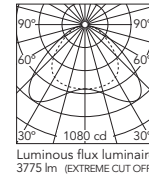

Beam Angle: 109°

h(m)	E lx	D(m)
1	1080	2.81
2	270	5.63
3	120	8.44
4	68	11.25
5	43	14.06

Super Flat Suspension 60x60 Up&Down

Light Source: Top LED 3000K/CRI 90 / 4000K/CRI 90

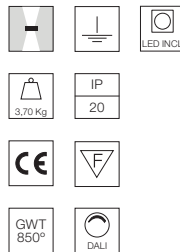
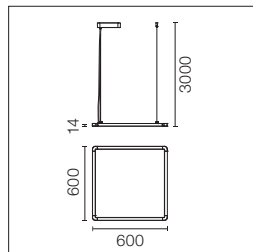

LED-Leuchte für die direkte und indirekte Allgemeinbeleuchtung. Hängeleuchte für die Deckenmontage. Netzteil 220/240V eingeschlossen.

General lighting LED luminaire, direct and indirect beam, to be suspended from ceiling. Power supply 220/240V included.

3000K
Light Source:
Up: Max. 2410 lm.
Down: Max. 2410 lm.
Lichtausbeute der Leuchte:
Max. 115 lm/W

4000K
Light Source:
Up: Max. 2651 lm.
Down: Max. 2651 lm.
Lichtausbeute der Leuchte:
Max. 126 lm/W.

3000K
Light Source:
Up: Max. 2410 lm.
Down: Max. 2410 lm.
Luminous efficiency of luminaire:
Max. 115 lm/W

4000K
Light Source:
Up: Max. 2651 lm.
Down: Max. 2651 lm.
Luminous efficiency of luminaire:
Max. 126 lm/W.

Gesamtverbrauch des Systems:
40W.

Total consumption of the system:
40W.

- 3000K**
Non Dimmable
- ☐ 09.5015.30B
 - ▒ 09.5015.02B
 - 09.5015.14B
- Dali Version
- ☐ 09.5015.30BDA
 - ▒ 09.5015.02BDA
 - 09.5015.14BDA

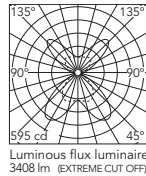

Beam Angle DIR: 52°

h(m)	E lx	D(m)
1	595	1.37
2	149	2.73
3	66	4.10
4	37	5.47
5	24	6.83

- 4000K**
Non Dimmable
- ☐ 09.5016.30B
 - ▒ 09.5016.02B
 - 09.5016.14B
- Dali Version
- ☐ 09.5016.30BDA
 - ▒ 09.5016.02BDA
 - 09.5016.14BDA

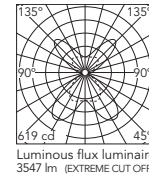

Beam Angle DIR: 52°

h(m)	E lx	D(m)
1	619	1.37
2	155	2.73
3	69	4.10
4	39	5.47
5	25	6.83

SUPER FLAT

Super Flat Suspension 90x90 Down

Light Source: Top LED 3000K/CRI 90 / 4000K/CRI 90

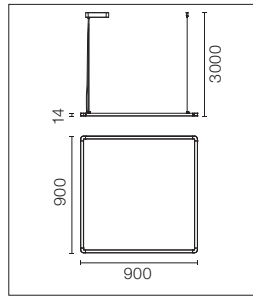

LED-Leuchte für die Allgemeinbeleuchtung. Hängeleuchte für die Deckenmontage. Netzteil 220/240V eingeschlossen.

General lighting LED luminaire to be suspended from ceiling. Power supply 220/240V included.

3000K

Light Source:
Max. 6964 lm.
Lichtausbeute der Leuchte:
Max. 138 lm/W

4000K

Light Source:
Max. 7660 lm.
Lichtausbeute der Leuchte:
Max. 151 lm/W.

3000K

Light Source:
Max. 6964 lm.
Luminous efficiency of luminaire:
Max. 138 lm/W

4000K

Light Source:
Max. 7660 lm.
Luminous efficiency of luminaire:
Max. 151 lm/W.

Gesamtverbrauch des Systems:
55W.

Total consumption of the system:
55W.

3000K

Non Dimmable

- 09.5020.30B
- 09.5020.02B
- 09.5020.14B
- Dali Version
- 09.5020.30BDA
- 09.5020.02BDA
- 09.5020.14BDA

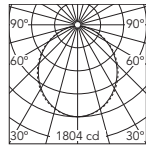

Beam Angle: 104°

h(m)	E(lx)	D(m)
1	1804	2.58
2	451	5.15
3	200	7.73
4	113	10.31
5	72	12.88

Luminous flux luminaire
4802 lm (EXTREME CUT OFF)

4000K

Non Dimmable

- 09.5021.30B
- 09.5021.02B
- 09.5021.14B
- Dali Version
- 09.5021.30BDA
- 09.5021.02BDA
- 09.5021.14BDA

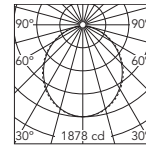

Beam Angle: 104°

h(m)	E(lx)	D(m)
1	1878	2.58
2	469	5.15
3	209	7.73
4	117	10.31
5	75	12.88

Luminous flux luminaire
4998 lm (EXTREME CUT OFF)

Super Flat Suspension 90x90 Up&Down

Light Source: Top LED 3000K/CRI 90 / 4000K/CRI 90

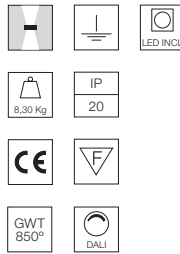
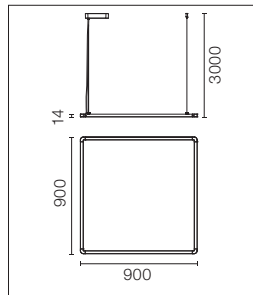

LED-Leuchte für die direkte und indirekte Allgemeinbeleuchtung. Hängeleuchte für die Deckenmontage. Netzteil 220/240V eingeschlossen.

General lighting LED luminaire, direct and indirect beam, to be suspended from ceiling. Power supply 220/240V included.

3000K

Light Source:
Up: Max. 3482 lm.
Down: Max. 3482 lm.
Lichtausbeute der Leuchte:
Max. 138 lm/W

4000K

Light Source:
Up: Max. 3830 lm.
Down: Max. 3830 lm.
Lichtausbeute der Leuchte:
Max. 151 lm/W

3000K

Light Source:
Up: Max. 3482 lm.
Down: Max. 3482 lm.
Luminous efficiency of luminaire:
Max. 138 lm/W

4000K

Light Source:
Up: Max. 3830 lm.
Down: Max. 3830 lm.
Luminous efficiency of luminaire:
Max. 151 lm/W

Gesamtverbrauch des Systems:
55W.

Total consumption of the system:
55W.

3000K

Non Dimmable

- 09.5025.30B
- 09.5025.02B
- 09.5025.14B
- Dali Version
- 09.5025.30BDA
- 09.5025.02BDA
- 09.5025.14BDA

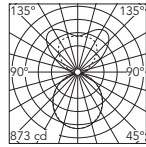

Beam Angle DIR: 108°

h(m)	E(lx)	D(m)
1	873	2.75
2	218	5.49
3	97	8.24
4	55	10.98
5	35	13.73

Luminous flux luminaire
4450 lm (EXTREME CUT OFF)

4000K

Non Dimmable

- 09.5026.30B
- 09.5026.02B
- 09.5026.14B
- Dali Version
- 09.5026.30BDA
- 09.5026.02BDA
- 09.5026.14BDA

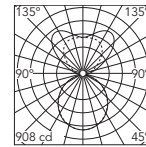

Beam Angle DIR: 108°

h(m)	E(lx)	D(m)
1	908	2.75
2	227	5.49
3	101	8.24
4	57	10.98
5	36	13.73

Luminous flux luminaire
4631 lm (EXTREME CUT OFF)

SUPER FLAT

Super Flat Suspension 120x30 Down

Light Source: Top LED 3000K/CRI 90 / 4000K/CRI 90

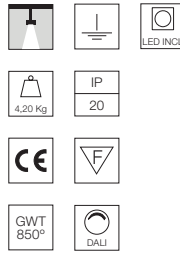
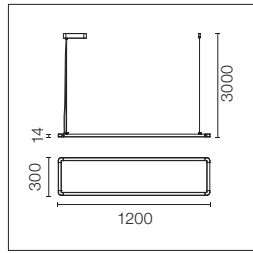

LED-Leuchte für die Allgemeinbeleuchtung. Hängeleuchte für die Deckenmontage. Netzteil 220/240V eingeschlossen.

General lighting LED luminaire to be suspended from ceiling. Power supply 220/240V included.

3000K

Light Source:
Max. 6964 lm.
Lichtausbeute der Leuchte:
Max. 138 lm/W

4000K

Light Source:
Max. 7660 lm.
Lichtausbeute der Leuchte:
Max. 151 lm/W.

3000K

Light Source:
Max. 6964 lm.
Luminous efficiency of luminaire:
Max. 138 lm/W

4000K

Light Source:
Max. 7660 lm.
Luminous efficiency of luminaire:
Max. 151 lm/W.

Gesamtverbrauch des Systems:
56W.

Total consumption of the system:
56W.

3000K

Non Dimmable

- 09.5040.30B
- 09.5040.02B
- 09.5040.14B
- Dali Version
- 09.5040.30BDA
- 09.5040.02BDA
- 09.5040.14BDA

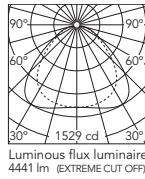

Beam Angle: 105°

h(m)	E(lx)	D(m)
1	1529	2.62
2	382	5.25
3	170	7.87
4	96	10.49
5	61	13.12

Luminous flux luminaire
4441 lm (EXTREME CUT OFF)

4000K

Non Dimmable

- 09.5041.30B
- 09.5041.02B
- 09.5041.14B
- Dali Version
- 09.5041.30BDA
- 09.5041.02BDA
- 09.5041.14BDA

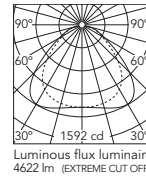

Beam Angle: 105°

h(m)	E(lx)	D(m)
1	1592	2.62
2	398	5.25
3	177	7.87
4	99	10.49
5	64	13.12

Luminous flux luminaire
4622 lm (EXTREME CUT OFF)

Super Flat Suspension 120x30 Up&Down

Light Source: Top LED 3000K/CRI 90 / 4000K/CRI 90

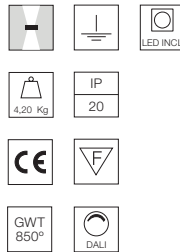
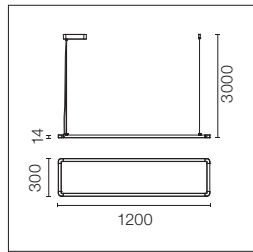

LED-Leuchte für die direkte und indirekte Allgemeinbeleuchtung. Hängeleuchte für die Deckenmontage. Netzteil 220/240V eingeschlossen.

General lighting LED luminaire, direct and indirect beam, to be suspended from ceiling. Power supply 220/240V included.

3000K

Light Source:
Up: Max. 3482 lm.
Down: Max. 3482 lm.
Lichtausbeute der Leuchte:
Max. 138 lm/W

4000K

Light Source:
Up: Max. 3830 lm.
Down: Max. 3830 lm.
Lichtausbeute der Leuchte:
Max. 151 lm/W

3000K

Light Source:
Up: Max. 3482 lm.
Down: Max. 3482 lm.
Luminous efficiency of luminaire:
Max. 138 lm/W

4000K

Light Source:
Up: Max. 3830 lm.
Down: Max. 3830 lm.
Luminous efficiency of luminaire:
Max. 151 lm/W

Gesamtverbrauch des Systems:
56W.

Total consumption of the system:
56W.

3000K

Non Dimmable

- 09.5045.30B
- 09.5045.02B
- 09.5045.14B
- Dali Version
- 09.5045.30BDA
- 09.5045.02BDA
- 09.5045.14BDA

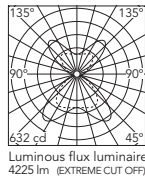

Beam Angle DIR: 109°

h(m)	E(lx)	D(m)
1	632	2.82
2	158	5.64
3	70	8.46
4	40	11.27
5	25	14.09

Luminous flux luminaire
4225 lm (EXTREME CUT OFF)

4000K

Non Dimmable

- 09.5046.30B
- 09.5046.02B
- 09.5046.14B
- Dali Version
- 09.5046.30BDA
- 09.5046.02BDA
- 09.5046.14BDA

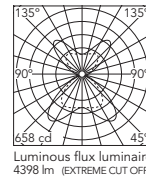

Beam Angle DIR: 109°

h(m)	E(lx)	D(m)
1	658	2.82
2	165	5.64
3	73	8.46
4	41	11.27
5	26	14.09

Luminous flux luminaire
4398 lm (EXTREME CUT OFF)

SUPER FLAT

Super Flat Surface 60x60 Down

Light Source: Top LED 3000K/CRI 90 / 4000K/CRI 90

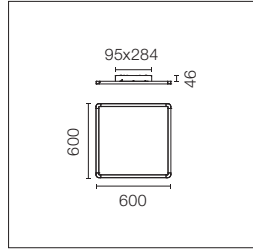

LED-Leuchte zur Deckenmontage für die Allgemeinbeleuchtung. Netzteil 220/240V eingeschlossen.

Surface mounted general lighting LED luminaire. Power supply 220/240V included.

3000K
Light Source:
Max. 4821 lm.
Lichtausbeute der Leuchte:
Max. 115 lm/W

3000K
Light Source:
Max. 4821 lm.
Luminous efficiency of luminaire:
Max. 115 lm/W

4000K
Light Source:
Max. 5303 lm.
Lichtausbeute der Leuchte:
Max. 126 lm/W.

4000K
Light Source:
Max. 5303 lm.
Luminous efficiency of luminaire:
Max. 126 lm/W.

Gesamtverbrauch des Systems:
40W.

Total consumption of the system:
40W.

- 3000K**
Non Dimmable
- 09.6010.30B
 - 09.6010.02B
 - 09.6010.14B
- Dali Version
- 09.6010.30BDA
 - 09.6010.02BDA
 - 09.6010.14BDA

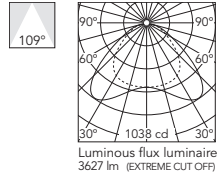

Beam Angle: 109°

h(m)	E(lx)	D(m)
1	1038	2.81
2	259	5.63
3	115	8.44
4	65	11.25
5	42	14.06

- 4000K**
Non Dimmable
- 09.6011.30B
 - 09.6011.02B
 - 09.6011.14B
- Dali Version
- 09.6011.30BDA
 - 09.6011.02BDA
 - 09.6011.14BDA

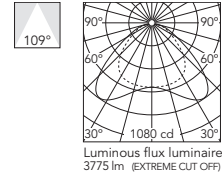

Beam Angle: 109°

h(m)	E(lx)	D(m)
1	1080	2.81
2	270	5.63
3	120	8.44
4	68	11.25
5	43	14.06

Super Flat Surface 90x90 Down

Light Source: Top LED 3000K/CRI 90 / 4000K/CRI 90

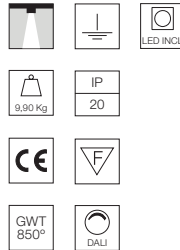
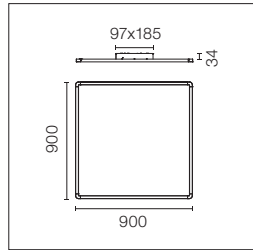

LED-Leuchte für die Allgemeinbeleuchtung. Hängeleuchte für die Deckenmontage. Netzteil 220/240V eingeschlossen.

Surface mounted general lighting LED luminaire. Power supply 220/240V included.

3000K
Light Source:
Max. 6964 lm.
Lichtausbeute der Leuchte:
Max. 138 lm/W

3000K
Light Source:
Max. 6964 lm.
Luminous efficiency of luminaire:
Max. 138 lm/W

4000K
Light Source:
Max. 7660 lm.
Lichtausbeute der Leuchte:
Max. 151 lm/W.

4000K
Light Source:
Max. 7660 lm.
Luminous efficiency of luminaire:
Max. 151 lm/W.

Gesamtverbrauch des Systems:
55W.

Total consumption of the system:
55W.

- 3000K**
Non Dimmable
- 09.6020.30B
 - 09.6020.02B
 - 09.6020.14B
- Dali Version
- 09.6020.30BDA
 - 09.6020.02BDA
 - 09.6020.14BDA

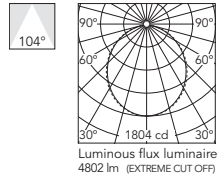

Beam Angle: 104°

h(m)	E(lx)	D(m)
1	1804	2.58
2	451	5.15
3	200	7.73
4	113	10.31
5	72	12.88

- 4000K**
Non Dimmable
- 09.6021.30B
 - 09.6021.02B
 - 09.6021.14B
- Dali Version
- 09.6021.30BDA
 - 09.6021.02BDA
 - 09.6021.14BDA

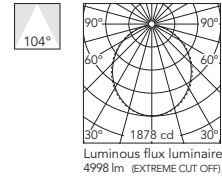

Beam Angle: 104°

h(m)	E(lx)	D(m)
1	1878	2.58
2	469	5.15
3	209	7.73
4	117	10.31
5	75	12.88

SUPER FLAT

Super Flat Surface 120x30 Down

Light Source: Top LED 3000K/CRI 90 / 4000K/CRI 90

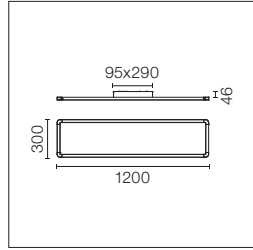

LED-Leuchte zur Deckenmontage für die Allgemeinbeleuchtung. Netzteil 220/240V eingeschlossen.

Surface mounted general lighting LED luminaire. Power supply 220/240V included.

3000K

Light Source:
Max. 6964 lm.
Lichtausbeute der Leuchte:
Max. 138 lm/W

4000K

Light Source:
Max. 7660 lm.
Lichtausbeute der Leuchte:
Max. 151 lm/W.

3000K

Light Source:
Max. 6964 lm.
Luminous efficiency of luminaire:
Max. 138 lm/W

4000K

Light Source:
Max. 7660 lm.
Luminous efficiency of luminaire:
Max. 151 lm/W.

Gesamtverbrauch des Systems:
56W.

Total consumption of the system:
56W.

3000K

Non Dimmable

09.6040.30B

09.6040.02B

09.6040.14B

Dali Version

09.6040.30BDA

09.6040.02BDA

09.6040.14BDA

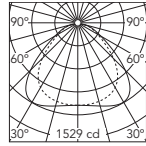

Beam Angle: 105°

h(m)	E(lx)	D(m)
1	1529	2.62
2	382	5.25
3	170	7.87
4	96	10.49
5	61	13.12

Luminous flux luminaire
4441 lm (EXTREME CUT OFF)

4000K

Non Dimmable

09.6041.30B

09.6041.02B

09.6041.14B

Dali Version

09.6041.30BDA

09.6041.02BDA

09.6041.14BDA

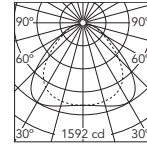

Beam Angle: 105°

h(m)	E(lx)	D(m)
1	1592	2.62
2	398	5.25
3	177	7.87
4	99	10.49
5	64	13.12

Luminous flux luminaire
4622 lm (EXTREME CUT OFF)

LIGHT BELL

DESIGNED BY PIERO LISSONI



LIGHT SOURCE
LED ARRAY
55W
6388 lm
2700K/CRI 90
6714 lm
3000K/CRI 90

Außen / Outside

□ 70 Mattweiss
70 Matt White

■ AP Hochglänzendes Aluminium
AP Polished Aluminium

■ AN Eloxiertes Schwarz
AN Anodized Black

Innen / Inside

■ Eloxiertes Aluminium
Anodized Aluminium

■ Eloxiertes Aluminium
Anodized Aluminium

■ Gold
Gold



Außen / Outside

■ 18 Dunkelbraun
18 Dark Brown

■ 7C Mattschwarz
7C Matt Black

Innen / Inside

■ Gold
Gold

■ Galvanisiertes Kupfer
Galvanic Copper



Außen / Innen
Outside / Inside

□ 76 Glas Transparent
76 Transparent Glass

■ CE Zement
CE Concrete



LIGHT BELL

Produktbeschreibung

Hängeleuchte für Allgemeinbeleuchtung zur Installation in Innenräumen. Mit leistungsstarker LED-Lichtquelle der jüngsten Generation und thermoplastischem Diffusor für geringen Energieverlust.

Der Leuchtenreflektor wird gesondert geliefert und ist je nach Version aus präzisionsgedrücktem Aluminium in verschiedenen Dekors und aus transparentem Glas erhältlich. Netzteil im Leuchtenkörper integriert.

Betriebsgerät

Integriertes Konstantstrom-Netzteil 220/240V.

Zusatzinformationen

Erhältlich in den Versionen Dali und Dimmable Push.

Schutzgrad IP20.

Schutzklasse I.

Abstrahler vom Typ Pin-Block.

Qualitätszeichen

Das Gerät entspricht der europäischen technischen Norm EN60598-1 und den entsprechenden Zusatzregelungen.

Description

Suspended general lighting luminaire for indoor mounting. It has a high efficiency latest generation LED light source and a low-loss technical thermoplastic diffuser.

The reflector is supplied separately and is available in spun aluminium with different patterns, and in transparent glass, depending on the versions. Power supply source integrated into luminaire housing.

Power Supply

Integrated 220/240V constant voltage power supply source.

Additional Information

Available in Dali, and Dimmable Push versions.

IP20 protection grade.

Insulation class I.

Pin-block type dissipater.

Standard Compliance and Quality Marks

EN60598-1 European Technical Standards and any subsequent additions.



LIGHT BELL

Light Bell Light Source

Light Source: LED Array 55W - 6388 lm - 2700K/CRI 90 / 55W - 6714 lm - 3000K/CRI 90

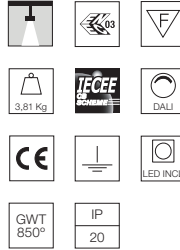
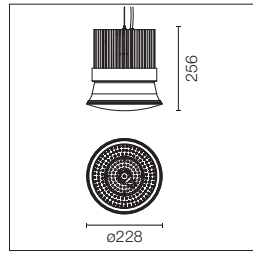

LED Pendelleuchte für Deckeninstallation (Höchstabstand zur Decke 4 meter). Netzteil 220/240V im Leuchtenkörper integriert. Reflektor ist nicht eingeschlossen, wird gesondert geliefert. Bitte melden Sie sich für eine höhere Schutzart. Enthält Kabelaufhängung von 4m.

Suspended luminaire for mounting on the ceiling with LED light source. (4 metres maximum distance to ceiling). Power supply source 220/240V integrated into luminaire housing. Reflector not included; supplied separately. Please ask us for a higher IP. Includes a 4-meter suspension cable.

2700K

Non Dimmable

- 07.9641.14A
- Dimmable Push
- 07.9641.14ADP
- Dimmable Dali
- 07.9641.14ADA

3000K

Non Dimmable

- 07.9642.14A
- Dimmable Push
- 07.9642.14ADP
- Dimmable Dali
- 07.9642.14ADA

Light Bell Reflector

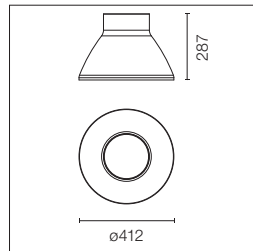

□ 07.9630.70



E I **2700K**
□ 07.9630.70
+
07.9641.14A

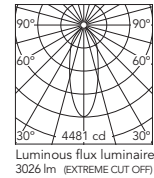

E I **3000K**
□ 07.9630.70
+
07.9642.14A

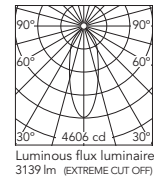

■ 07.9630.AP



E I **2700K**
■ 07.9630.AP
+
07.9641.14A

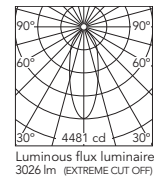

E I **3000K**
■ 07.9630.AP
+
07.9642.14A

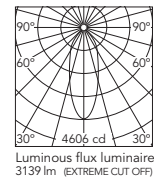

■ 07.9630.AN



E I **2700K**
■ 07.9630.AN
+
07.9641.14A

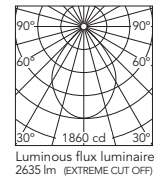

E I **3000K**
■ 07.9630.AN
+
07.9642.14A

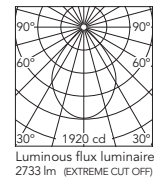

E= Außenfarbe
I= Innenfarbe

E= External Finish
I= Internal Finish

LIGHT BELL

Light Bell Reflector



07.9630.18



E I 2700K
07.9630.18
+
07.9641.14A

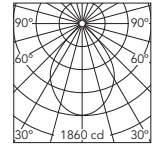

Luminous flux luminaire
2635 lm (EXTREME CUT OFF)

Beam Angle: 78°

h(m)	E(lx)	D(m)
1	1860	1.61
2	465	3.22
3	207	4.84
4	116	6.45
5	74	8.06

E I 3000K
07.9630.18
+
07.9642.14A

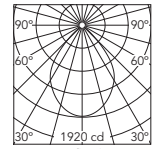

Luminous flux luminaire
2733 lm (EXTREME CUT OFF)

Beam Angle: 78°

h(m)	E(lx)	D(m)
1	1920	1.62
2	480	3.23
3	213	4.85
4	120	6.47
5	77	8.08



07.9630.7C



E I 2700K
07.9630.7C
+
07.9641.14A

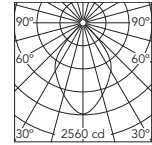

Luminous flux luminaire
3117 lm (EXTREME CUT OFF)

Beam Angle: 74°

h(m)	E(lx)	D(m)
1	2560	1.49
2	640	2.98
3	284	4.47
4	160	5.97
5	102	7.46

E I 3000K
07.9630.7C
+
07.9642.14A

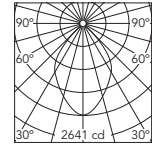

Luminous flux luminaire
3233 lm (EXTREME CUT OFF)

Beam Angle: 74°

h(m)	E(lx)	D(m)
1	2641	1.50
2	660	2.99
3	293	4.49
4	165	5.98
5	106	7.48



07.9630.76



2700K
07.9630.76
+
07.9641.14A

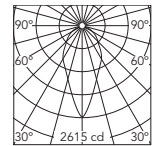

Luminous flux luminaire
3391 lm (EXTREME CUT OFF)

Beam Angle: 46°

h(m)	E(lx)	D(m)
1	2615	0.81
2	654	1.63
3	291	2.44
4	163	3.26
5	105	4.07

3000K
07.9630.76
+
07.9642.14A

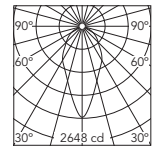

Luminous flux luminaire
3518 lm (EXTREME CUT OFF)

Beam Angle: 46°

h(m)	E(lx)	D(m)
1	2648	0.85
2	662	1.71
3	294	2.56
4	166	3.41
5	106	4.27



07.9630.CE



2700K
07.9630.CE
+
07.9641.14A

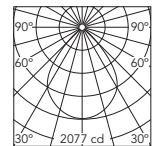

Luminous flux luminaire
3099 lm (EXTREME CUT OFF)

Beam Angle: 79°

h(m)	E(lx)	D(m)
1	2077	1.66
2	519	3.32
3	231	4.97
4	130	6.63
5	83	8.29

3000K
07.9630.CE
+
07.9642.14A

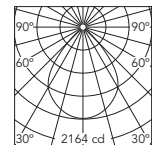

Luminous flux luminaire
3229 lm (EXTREME CUT OFF)

Beam Angle: 79°

h(m)	E(lx)	D(m)
1	2164	1.66
2	541	3.32
3	240	4.97
4	135	6.63
5	87	8.29

Zubehör / Accessories

Rosette für Innenräume. IP20.

Rosette for indoors. IP20.



Non Dimmable
F0556020
Dimmable Push/'Dali
F0557020

* Die DALI-Version F0557020 verfügt über 4 m Kabel, 5 Pole und 0,75 mm² Querschnitt.

* The F0557020 Dali version has a 4-meter cable, 5 poles and a 0.75mm² section.

Rosette. IP54.

Rosette. IP54.



08.8775.40

FORT KNOX WALL

DESIGNED BY PHILIPPE STARCK

FORT KNOX WALL



LIGHT SOURCE

POWER LED
35W
2930 lm
2700K/CRI 90
3900 lm
3000K/CRI 90
3256 lm
4000K/CRI 90

FORT KNOX WALL MINI



LIGHT SOURCE

POWER LED
25W
1885 lm
2700K/CRI 90
2700 lm
3000K/CRI 90
2133 lm
4000K/CRI 90

□ 40 Weiss
40 White

◻ 05 Hochglänzendem
05 Polished Aluminium

■ 14 Schwarz/RAL 9005
14 Black



Produktbeschreibung

Wandleuchte mit indirektem Licht.
Leuchtenkörper aus Aluminiumlegierungsdruckguss, handpoliert und mit flüssigem, transparentem Schutzlack überzogen oder weiß oder mattschwarz pulverlackiert.
Wandsupport aus Aluminiumdruckguss.
Dank ihres innovativen Designs erlaubt diese Halterung sowohl eine horizontale als auch vertikale Orientierung von bis zu 10 mm und garantiert eine perfekte Installation auf jeder Oberfläche. Zudem erlaubt die integrierte Wasserwaage dieses Fabrikats eine perfekte Ausrichtung der Leuchte.

Reflektoren

Asymmetrische Linse, die dank ihrem speziellen Design eine maximale Effizienz der Beleuchtung und eine optimale Ausleuchtung garantiert.

Betriebsgerät

Nicht dimmbare, Mains Dim, dimmbare 1-10V oder dimmbare Dali-Stromquelle im Leuchtenkörper integriert.

Zusatzinformationen

Schutzgrad IP20.
Schutzklasse I.

Qualitätszeichen

Das Gerät entspricht der europäischen technischen Norm EN60598-1 und den entsprechenden Zusatzregelungen.

Description

Luminaire for wall application designed for indirect lighting.
Die-cast aluminium alloy body with hand polished finish and protected with transparent liquid paint, or powder-coated white or matt black.
Wall support made in injected aluminium. Thanks to its innovative design, this holder allows both horizontal and vertical regulation up to 10 mm, ensuring a perfect installation on any type of surface. Additionally, this product includes a spirit level, allowing a perfect luminaire calibration.

Reflectors

Thanks to its adapted design, the asymmetrical lens allow luminaire's maximum efficiency and optimal light distribution.

Power Supply

Non Dimmable, Dimmable 1-10V, Mains Dim or Dimmable Dali power source incorporated in the luminaire body.

Additional Information

IP20 protection grade.
Insulation class I.

Standard Compliance and Quality Marks

EN60598-1 European Technical Standards and any subsequent additions.

Fort Knox Wall

Light Source: Power LED 35W - 2930 lm - 2700K/CRI 90 / 35W - 3900 lm - 3000K/CRI 90 / 35W - 3256 lm - 4000K/CRI 90

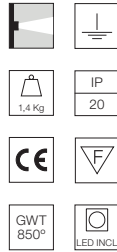
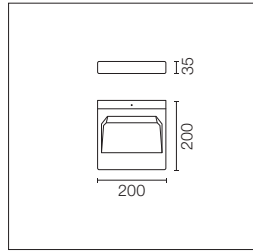

LED Deckenleuchte für indirekte Beleuchtung. Netzteil 220-240V in der Leuchte integriert.

Wall-mounted LED luminaire for indirect lighting. Power source 220-240V incorporated into luminaire's body.

2700K

Dimmable 1-10V

- 09.2111.40A
- 09.2111.05A
- 09.2111.14A
- Dali Version
- 09.2111.40ADA
- 09.2111.05ADA
- 09.2111.14ADA

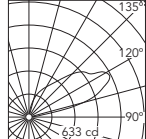

Luminous flux luminaire 2177 lm

Beam Angle: 39°

h(m)	E(lx)	D(m)
1	633	3.39
2	158	6.77
3	70	10.16
4	40	13.55
5	25	16.94

3000K

Dimmable 1-10V

- 09.2110.40C
- 09.2110.05C
- 09.2110.14C
- Dali Version
- 09.2110.40CDA
- 09.2110.05CDA
- 09.2110.14CDA

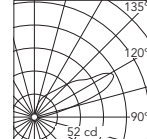

Luminous flux luminaire 3036 lm

Beam Angle: 30°

h(m)	E(lx)	D(m)
1	52	18.90
2	12	37.79
3	6	56.69
4	3	75.58
5	3	94.48

4000K

Dimmable 1-10V

- 09.2112.40A
- 09.2112.05A
- 09.2112.14A
- Dali Version
- 09.2112.40ADA
- 09.2112.05ADA
- 09.2112.14ADA

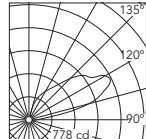

Luminous flux luminaire 2676 lm

Beam Angle: 39°

h(m)	E(lx)	D(m)
1	778	3.39
2	194	6.77
3	86	10.16
4	49	13.55
5	31	16.94

Fort Knox Wall Mini

Light Source: Power LED 25W - 1885 lm - 2700K/CRI 90 / 25W - 2700 lm - 3000K/CRI 90 / 25W - 2133 lm - 4000K/CRI 90

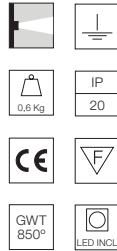
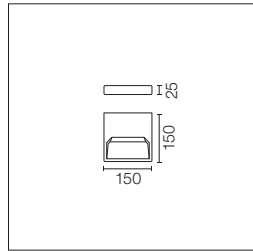

LED Deckenleuchte für indirekte Beleuchtung. Netzteil 220-240V in der Leuchte integriert.

Wall-mounted LED luminaire for indirect lighting. Power source 220-240V incorporated into luminaire's body.

2700K

Non Dimmable

- 09.2126.40
- 09.2126.05
- 09.2126.14
- Mains Dimming
- 09.2126.40.DM
- 09.2126.05.DM
- 09.2126.14.DM

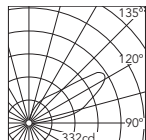

Luminous flux luminaire 1440 lm

Beam Angle: 39°

h(m)	E(lx)	D(m)
1	332	3.50
2	83	6.99
3	37	10.49
4	21	13.99
5	13	17.49

3000K

Non Dimmable

- 09.2125.40B
- 09.2125.05B
- 09.2125.14B
- Mains Dimming
- 09.2125.40BDM
- 09.2125.05BDM
- 09.2125.14BDM

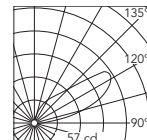

Luminous flux luminaire 1972 lm

Beam Angle: 33°

h(m)	E(lx)	D(m)
1	57	18.96
2	14	37.92
3	6	56.87
4	4	75.83
5	2	94.79

4000K

Non Dimmable

- 09.2127.40
- 09.2127.05
- 09.2127.14
- Mains Dimming
- 09.2127.40.DM
- 09.2127.05.DM
- 09.2127.14.DM

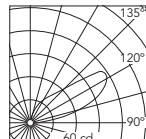

Luminous flux luminaire 2080 lm

Beam Angle: 33°

h(m)	E(lx)	D(m)
1	60	18.96
2	15	37.92
3	6	56.87
4	4	75.83
5	2	94.79

THIN LED

DESIGNED BY FLOS ARCHITECTURAL



LIGHT SOURCE
TOP LED
20W/m
24V
1822 lm/m
3000K/CRI 90

□ 30 Weiss
30 White



■ 29 Eloxiertes Aluminium
29 Anodized Aluminium



■ BZ Eloxiertes Bronze
BZ Anodized Bronze



Dies Modell wurde patentiert und eingetragen / Patented and registered model.

Produktbeschreibung

Wandleuchte für indirekte Beleuchtung.
Eloxiertes Aluminiumgehäuse mit integriertem optischem Reflektor aus hochreinem Aluminium. Besonders einfache Installation und extrem vielseitig. Die Platine besteht aus Verbindungsmodulen mit Doppelverbindern über Silberkontakte. So wird eine sichere Stromversorgung gewährleistet und Schäden bei der Montage vermieden.
Die LEDs mit sehr geringem Abstand und einem 120°-Abstrahlwinkel sorgen gemeinsam mit dem Reflexionssystem für eine sehr hohe und ausgeglichene Beleuchtungsleistung. Ein patentiertes Beleuchtungssteuerungssystem garantiert eine sehr hohe Leuchtleistung mit optimierter und höchst angenehmer Lichtverteilung.

Betriebsgerät

24-V-Netzgeräte erhältlich für 20W bis 100W Leistung (Länge 3 Meter).
Dimmer-Systeme mit 1-10V oder Dali verfügbar.

Zusatzinformationen

LED-Module: 404 mm - 1201 mm - 1034 mm - 2040 mm - 2541 mm - 3042 mm.
Blindmodul: 1034 mm.
Max. Anschlusslänge: 3.044 mm.
Seitenabdeckung wird mitgeliefert.
Schutzgrad IP20.
Schutzklasse III.
Auf normal entflammaren Oberflächen einsetzbar.

Qualitätszeichen

Das Gerät entspricht der europäischen technischen Norm EN60598-1 und den entsprechenden Zusatzregelungen.

Description

Wall application luminaire for indirect lighting.
Anodised aluminium housing with internal super-pure optical aluminium reflector. Very easy to install and extremely versatile. The printed circuit is made of jointed modules with double connector through silver contacts. This ensures a safe power supply avoiding damages which could be caused during assembling phase.
The utilized LED, with a very tight pitch and a 120° emission, together with the reflection system, grant a very high and even lighting emission performance. Thanks to a patented light emission control system, the light fitting performance is really high, with an optimized and very comfortable light distribution.

Power Supply

24V power supplies available with a power of between 20W and 100W (3 metres in length).
Control system with 1-10V dimmer or Dali available.

Additional Information

Led modules: 404 mm - 1201 mm - 1034 mm - 2040 mm - 2541 mm - 3042 mm.
Blind module: 1034 mm.
Max connection length 3044 mm.
Side covers included.
IP20 protection grade.
Classe d'isolation III.
Suitable for installation on normally inflammable surfaces.

Standard Compliance and Quality Marks

EN60598-1 European Technical Standards and any subsequent additions.



THIN LED

Thin LED

Light Source: Top LED 20W/m - 24V - 1822 lm/m - 3000K/CRI 90

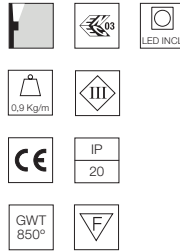
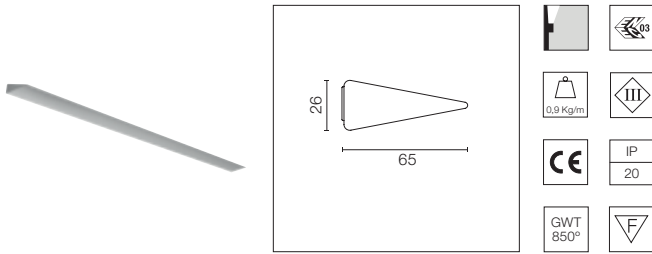

Wandleuchte für LED indirekte Beleuchtung. Fern-Driver ist nicht eingeschlossen.

Wall application luminaire for indirect lighting with LED. Remote transformer not included.

L: 404 mm

6,8W - 711 lm - 16 LEDs

- 09.0045.30B
- 09.0045.29B
- 09.0045.BZB

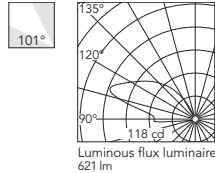

Beam Angle: 101°

h(m)	E(lx)	D(m)
1	118	6.46
2	30	12.92
3	13	19.38
4	7	25.84
5	5	32.30

L: 2040 mm

41W - 4266 lm - 84 LEDs

- 09.0101.30B
- 09.0101.29B
- 09.0101.BZB

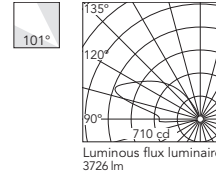

Beam Angle: 101°

h(m)	E(lx)	D(m)
1	710	6.46
2	178	12.92
3	79	19.38
4	44	25.84
5	28	32.30

L: 1034 mm

20,5W - 2133 lm - 42 LEDs

- 09.0100.30B
- 09.0100.29B
- 09.0100.BZB

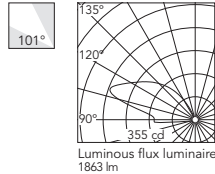

Beam Angle: 101°

h(m)	E(lx)	D(m)
1	355	6.46
2	89	12.92
3	39	19.38
4	22	25.84
5	14	32.30

L: 2541 mm

47,8W - 5250 lm - 105 LEDs

- 09.0102.30B
- 09.0102.29B
- 09.0102.BZB

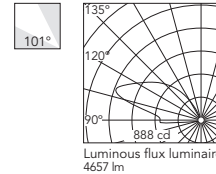

Beam Angle: 101°

h(m)	E(lx)	D(m)
1	888	6.46
2	222	12.92
3	99	19.38
4	55	25.84
5	36	32.30

L: 1201 mm

23,9W - 2450 lm - 55 LEDs

- 09.0120.30B
- 09.0120.29B
- 09.0120.BZB

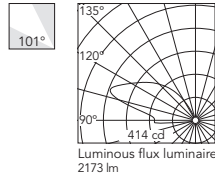

Beam Angle: 101°

h(m)	E(lx)	D(m)
1	414	6.46
2	104	12.92
3	46	19.38
4	26	25.84
5	17	32.30

L: 3042 mm

61,5W - 6399 lm - 126 LEDs

- 09.0103.30B
- 09.0103.29B
- 09.0103.BZB

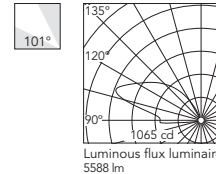

Beam Angle: 101°

h(m)	E(lx)	D(m)
1	1065	6.46
2	266	12.92
3	118	19.38
4	67	25.84
5	43	32.30

L: 1034 mm BLIND*

- 09.0104.30A
- 09.0104.29A
- 09.0104.BZA

* Um gleichmäßige Profillinien zu erstellen / To create continuous profile lines.

Treiber / Drivers

Elektronischer Transformator für LED mit beständiger Spannung (24V) – 100/240 V.

Electronic transformer with constant voltage (24V) for LED. 100/240V.

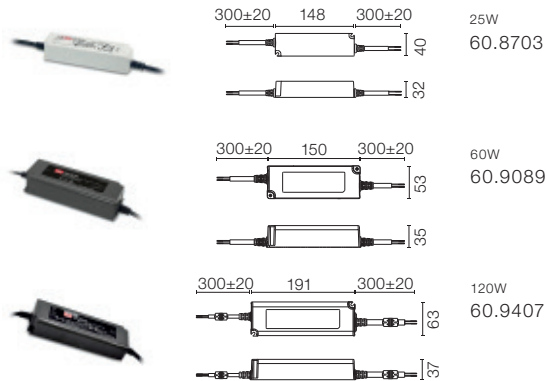

Steuereinheit für 1-10V-Dimmung; 1-Kanal-Steuerung für 24V-LED-Module; Netzgerät nicht begriffen. Max. 120W - 5A.

Dimmable 1-10V control unit with 1 channel for 24V LED modules. Power supply not included. Max. 120W - 5A.

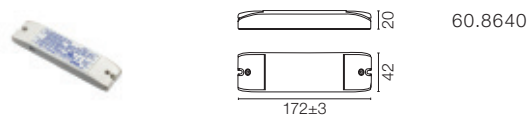





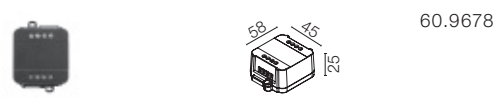

Steuereinheit für Dali-Dimmung; für 12 bis 48V-LED-Module; Netzgerät nicht begriffen. Maximale Länge 5 m/92,5W.

Dimmable Dali control unit for 12 to 48V LED modules. Power supply not included. Maximum length 5 m/92,5W.



WALL SYSTEM

DESIGNED BY ANTONIO CITTERIO

<p>BACK 1</p>  <p>LIGHT SOURCE TOP LED 6W 426 lm 3000K/CRI 80</p>	<p>BACK 1 OPTICAL SWITCH</p>  <p>LIGHT SOURCE TOP LED 8W 553 lm 3000K/CRI 80</p>	<p>BACK 2</p>  <p>LIGHT SOURCE TOP LED 8W 553 lm 3000K/CRI 80</p>	<p>UP&DOWN</p>  <p>LIGHT SOURCE POWER LED 4W 2X150 lm 3000K/CRI 82</p>	<p>MINIKELVIN WALL FLEX</p>  <p>LIGHT SOURCE TOP LED 4W 216 lm 3000K/CRI 85</p>	<p>MINIKELVIN FLEX</p>  <p>LIGHT SOURCE TOP LED 4W 216 lm 3000K/CRI 85</p>
--	---	--	---	---	---

Wall System

■ 57 Chrom
57 Chrome



Minikelvin

□ 09 Weiss
09 White



■ 57 Chrom
57 Chrome



■ 30 Schwarz
30 Black



Drehbar um 360° und schwenkbar 120°.
Can be rotated 360° and swivelled 120°.

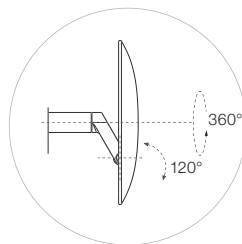

WALL SYSTEM

Produktbeschreibung

Produktfamilie von Wandleuchten mit indirektem Licht (Wall System Back), direktem Licht mit doppelter Lichtausstrahlung (Wall System Up&Down) und mit Streulicht (Wall System Minikelvin Flex und Minikelvin Wall Flex).

- Wall System Back und Wall System Up&Down:

Leuchtkörper aus druckgegossenem Aluminium mit Chrom-Finish, Wandbefestigung aus spritzgegossenem Polycarbonat. Der Streuschirm ist aus spritzgegossenem, innen fotografiertem Methacrylat.

- Wall System Minikelvin Flex:

Kopfteil aus verchromtem oder lackiertem druckgegossenem Aluminium (weiß/schwarz), auf Schlauch montiert, Streuschirm aus außen fotografiertem Methacrylat mit Aluminiumrahmen. Die Modelle Back, Up&Down und Minikelvin Flex sind in zwei Ausführungen verfügbar: Einbaugerät mit integriertem Treiber, mit runden Friesen (ø125) zur Wandmontage, aluminiumfarben, weiß oder schwarz, oder Einbaugerät mit Fernsteuerungstreiber, flächenbündig ohne Fries.

Bei der Ausführung mit integriertem Treiber werden als Schalung unterschiedslos Einbaugehäuse für Mauerwerk oder Gipskartonelemente verwendet, die in ganz Europa im Handel erhältlich sind; was den amerikanischen Markt betrifft, ist als Installationssystem ein Standard-Anschlusskasten vorgesehen.

- Minikelvin Wall Flex:

Kopfteil aus verchromtem oder lackiertem druckgegossenem Aluminium (weiß/schwarz), auf Schlauch montiert, Streuschirm aus außen fotografiertem Methacrylat mit Aluminiumrahmen. Wandbefestigung aus spritzgegossenem Polycarbonat (PC).

Einspeisung

Die Ausführungen mit integriertem Treiber sind mit einem elektronischen Transformator der neuesten Generation ausgestattet.

Zusatzinformationen

Schutzgrad IP20.

Schutzklasse III.

Auf normal entflammbaren Oberflächen einsetzbar.

Qualitätszeichen

Das Gerät entspricht der europäischen technischen Norm EN60598-1 und den entsprechenden Zusatzregelungen.

Description

Range of indirect-illumination (Wall System Back), dual-emission, direct-illumination (Wall System up&down) and diffuse illumination (Wall System Minikelvin Flex and Minikelvin Wall Flex) wall-mounted lighting devices.

- Wall System Back and Wall System Up&Down:

Body in die-cast aluminium with chrome finish, wall attachment in injection-stamped PC. The diffuser is in injection-stamped, internally photo-etched methacrylate.

- Wall System Minikelvin Flex:

Die-cast head in chrome finish or painted (black / white) mounted on flexible tube, diffuser in methacrylate externally photo-etched with aluminate frame.

For the Back, Up&Down and Minikelvin Flex models, two versions are available: recessed with integrated driver, which takes round wall ornamentals (ø125) in aluminium, white or black colour, or recessed with remote driver, flush with wall without ornamental. The version with integrated driver uses as casing either masonry boxes or plaster board, widely available all over Europe. For the US market, housing in the standard J-box is envisaged.

- Minikelvin Wall Flex:

Die-cast head in chrome finish or painted (black / white) mounted on flexible tube, diffuser in methacrylate externally photo-etched with aluminate frame. Wall attachment in injection-stamped PC.

Power Supply

Versions with integrated driver have a latest-generation electronic transformer.

Additional Information

IP20 protection grade.

Insulation class III.

Suitable for installation on normally inflammable surfaces.

Standard Compliance and Quality Marks

EN60598-1 European Technical Standards and any subsequent additions.

WALL SYSTEM

Wall System Back 1 Remote Power Supply

Light Source: Top LED 6W - 426 lm - 3000K/CRI 80

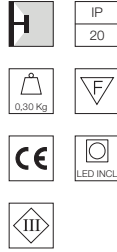
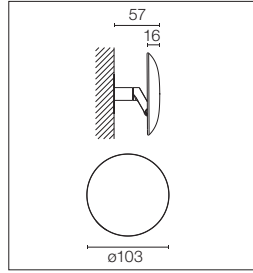

Leuchte zur flächenbündigen Montage mit indirektem Licht mit Fernsteuerungstreiber.

Indirect-illumination lighting device for installation flush with the wall with remote driver.

F9492057

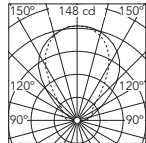

Luminous flux luminaire 269 lm

Beam Angle: 70°

h(m)	E(lx)	D(m)
1	148	2.05
2	37	4.10
3	16	6.16
4	9	8.21
5	6	10.26

Wall System Back 1 Power Supply Integrated

Light Source: Top LED 6W - 426 lm - 3000K/CRI 80

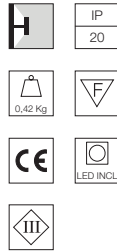
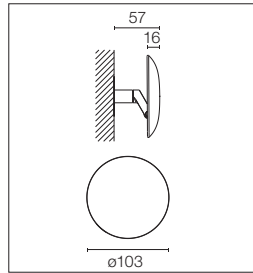

Wandleuchte mit indirektem Licht, integriertem Treiber und rundem Fries (ø125).

Indirect-illumination lighting device for wall mounting with integrated driver and with round ornamental (ø125).

Siehe erhältliches Zubehör. Für Installationen in Rigips muss ein Gehäuse mit den Mindestabmessungen 110,2 x 68,8 x 53,7 mm verwendet werden.

See available accessories. For installation on plasterboard, a box of minimum size 110.2 x 68.8 x 53.7 mm must be used.

F9494057

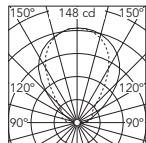

Luminous flux luminaire 269 lm

Beam Angle: 70°

h(m)	E(lx)	D(m)
1	148	2.05
2	37	4.10
3	16	6.16
4	9	8.21
5	6	10.26

Wall System Back 1 Remote Power Supply Optical Switch

Light Source: Top LED 6W - 426 lm - 3000K/CRI 80

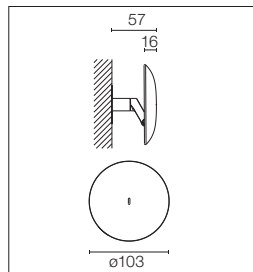

Leuchte zur flächenbündigen Montage mit indirektem Licht mit Fernsteuerungstreiber. ON/OFF-Schalter mit Soft-Touch-Technologie und Einstellung des Lichtstroms mit zwei Intensitäten (100 % - 50 % - 0 %).

Indirect-illumination lighting device for installation flush with the wall with remote driver.

ON/OFF switch with Soft Touch technology and light flow adjustment to 2 intensities (100% - 50% - 0%).

F9493057

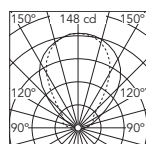

Luminous flux luminaire 269 lm

Beam Angle: 70°

h(m)	E(lx)	D(m)
1	148	2.05
2	37	4.10
3	16	6.16
4	9	8.21
5	6	10.26

WALL SYSTEM

Wall System Back 1 Power Supply Integrated Optical Switch

Light Source: Top LED 6W - 426 lm - 3000K/CRI 80

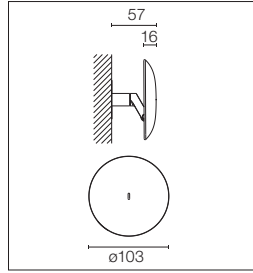

Wandleuchte mit indirektem Licht, integriertem Treiber und rundem Fries (ø125). ON/OFF-Schalter mit Soft-Touch-Technologie und Einstellung des Lichtstroms mit zwei Intensitäten (100% - 50% - 0%).

Indirect-illumination lighting device for wall mounting with integrated driver and with round ornamental (ø125). ON/OFF switch with Soft Touch technology and light flow adjustment to 2 intensities (100% - 50% - 0%).

Siehe erhältliches Zubehör.

See available accessories.

■ F9497057

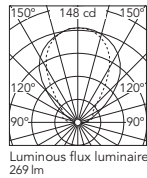

Beam Angle: 70°

h(m)	E(x)	D(m)
1	148	2.05
2	37	4.10
3	16	6.16
4	9	8.21
5	6	10.26

Wall System Back 2 Remote Power Supply

Light Source: Top LED 8W - 553 lm - 3000K/CRI 80

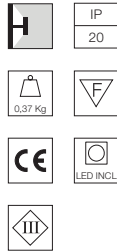
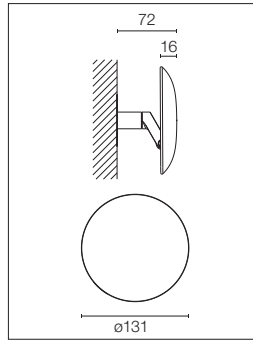

Leuchte zur flächenbündigen Montage mit indirektem Licht mit Fernsteuerungstreiber.

Indirect-illumination lighting device for installation flush with the wall with remote driver.

■ F9466057

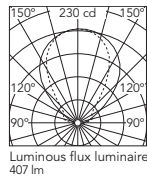

Beam Angle: 70°

h(m)	E(x)	D(m)
1	230	2.07
2	57	4.14
3	26	6.21
4	14	8.28
5	9	10.35

Wall System Back 2 Power Supply Integrated

Light Source: Top LED 8W - 553 lm - 3000K/CRI 80

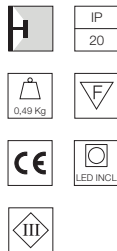
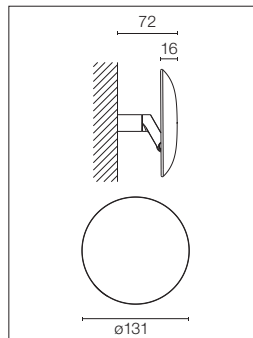

Wandleuchte mit indirektem Licht, integriertem Treiber und rundem Fries (ø125).

Indirect-illumination lighting device for wall mounting with integrated driver and with round ornamental (ø125).

Siehe erhältliches Zubehör. Für Installationen in Rigips muss ein Gehäuse mit den Mindestabmessungen 110,2 x 68,8 x 53,7 mm verwendet werden.

See available accessories. For installation on plasterboard, a box of minimum size 110.2 x 68.8 x 53.7 mm must be used.

■ F9467057

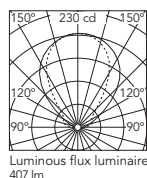

Beam Angle: 70°

h(m)	E(x)	D(m)
1	230	2.07
2	57	4.14
3	26	6.21
4	14	8.28
5	9	10.35

WALL SYSTEM

Wall System Up&Down Remote Power Supply

Light Source: Power LED 4W - 2x150 lm - 3000K/CRI 82

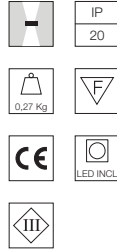
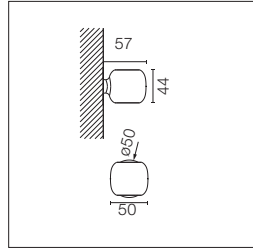

Leuchte zur flächenbündigen Montage mit doppelter Lichtausstrahlung mit Fernsteuerungstreiber.

Lighting device with dual emission bulb for installation flush with the wall with remote driver.

F9477057

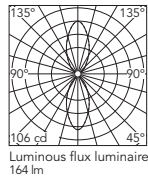

Beam Angle DIR: 49°

h(m)	E(lx)	D(m)
1	106	0.92
2	26	1.83
3	12	2.75
4	7	3.66
5	4	4.58

Wall System Up&Down Power Supply Integrated

Light Source: Power LED 4W - 2x150 lm - 3000K/CRI 82

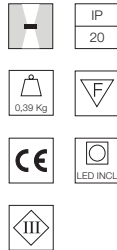
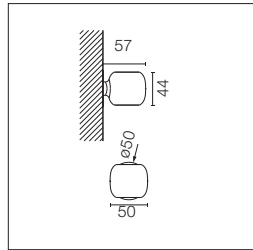

Wandleuchte mit doppelter Lichtausstrahlung mit integriertem Treiber und rundem Fries (ø125).

Lighting device with dual emission bulb for wall mounting with remote driver and with round ornamental (ø125).

Siehe erhältliches Zubehör. Für Installationen in Rigips muss ein Gehäuse mit den Mindestabmessungen 110,2 x 68,8 x 53,7 mm verwendet werden.

See available accessories. For installation on plasterboard, a box of minimum size 110.2 x 68.8 x 53.7 mm must be used.

F9474057

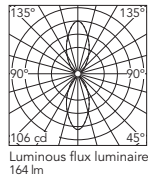

Beam Angle DIR: 49°

h(m)	E(lx)	D(m)
1	106	0.92
2	26	1.83
3	12	2.75
4	7	3.66
5	4	4.58

Minikelvin Wall Flex

Light Source: Top LED 4W - 216 lm - 3000K/CRI 85

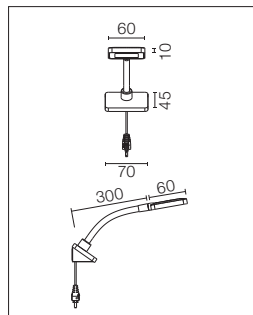

Wandleuchte mit Streulicht. Wandbefestigung aus druckgegossenem Aluminium. Vorschaltgerät: auf dem Stecker. Nutzlänge Kabel: 200 cm. ON/OFF-Schalter mit Soft-Touch-Technologie und Einstellung des Lichtstroms mit zwei Intensitäten (100 % - 50 % - 0 %).

Diffuse illumination lighting device for wall mounting Wall attachment in die-cast aluminium. The adaptor is on the plug and the useful cable length is 200 cm. ON/OFF switch with Soft Touch technology and light flow adjustment to 2 intensities (100% - 50% - 0%).

F4185009
F4185057
F4185030

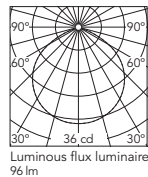

Beam Angle: 111°

h(m)	E(lx)	D(m)
1	36	2.89
2	9	5.77
3	4	8.66
4	2	11.55
5	1	14.44

WALL SYSTEM

Wall System Minikelvin Flex Remote Power Supply

Light Source: Top LED 4W - 216 lm - 3000K/CRI 85

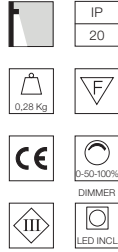
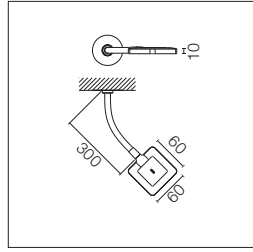

Leuchte zur flächenbündigen Montage mit Streulicht mit Fernsteuerungstreiber. ON/OFF-Schalter mit Soft-Touch-Technologie und Einstellung des Lichtstroms mit zwei Intensitäten (100% - 50% - 0%).

Diffuse illumination lighting device for installation flush with the wall with remote driver. ON/OFF switch with Soft Touch technology and light flow adjustment to 2 intensities (100% - 50% - 0%).

- F9478009
- ▒ F9478057
- F9478030

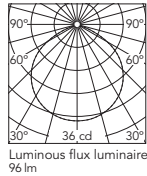

Beam Angle: 111°

h(m)	E(lx)	D(m)
1	36	2.89
2	9	5.77
3	4	8.66
4	2	11.55
5	1	14.44

Wall System Minikelvin Flex Power Supply Integrated

Light Source: Top LED 4W - 216 lm - 3000K/CRI 85

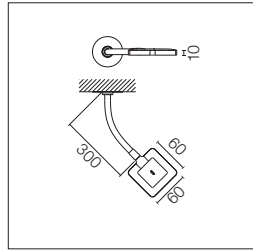

Leuchte zur flächenbündigen Montage mit Streulicht mit Fernsteuerungstreiber. ON/OFF-Schalter mit Soft-Touch-Technologie und Einstellung des Lichtstroms mit zwei Intensitäten (100% - 50% - 0%).

Diffuse illumination lighting device for installation flush with the wall with integrated driver and with round ornamental (ø125). ON/OFF switch with Soft Touch technology and light flow adjustment to 2 intensities (100% - 50% - 0%).

Siehe erhältliches Zubehör. Für Installationen in Rigips muss ein Gehäuse mit den Mindestabmessungen 110,2 x 68,8 x 53,7 mm verwendet werden.

See available accessories. For installation on plasterboard, a box of minimum size 110.2 x 68.8 x 53.7 mm must be used.

- F9463009
- ▒ F9463057
- F9463030

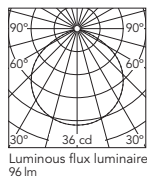

Beam Angle: 111°

h(m)	E(lx)	D(m)
1	36	2.89
2	9	5.77
3	4	8.66
4	2	11.55
5	1	14.44

Zubehör / Accessories

Unterputzdose für 3 module für mauerwerk, abmessungen 119x80x50 mm.

3-Module flush mounted box for masonry, measuring 119x80x50 mm.



80.8067

Treiber / Drivers

Elektronischer transformator für LED mit beständiger Spannung (24V). 220/240V, 50/60Hz.

Electronic transformer with constant voltage (24V) for LED. 220/240V, 50/60Hz.

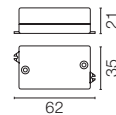

8W - Remote installation
60.8079

Elektronischer Transformator für LED mit beständiger Spannung (24V). 110/240V, 50/60Hz.

Electronic transformer with constant voltage (24V) for LED. 110/240V, 50/60Hz.

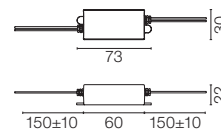

60.9157

G - O

DESIGNED BY JORGE HERRERA



LIGHT SOURCE
TOP LED
1,2W
105 lm
3000K/CRI 90

□ 30 Mattweiss
30 White

■ 29 Eloxiertes
Aluminium
29 Anodized
Aluminium

■ 55 Inox
55 Stainless
Steel

■ BZ Bronze
BZ Bronze

■ AN Eloxiertes
Schwarz
AN Anodized
Black



Lichtfarben
Light Colours

□ Weisses Licht
White Light

■ Amber Licht
Amber Light



Produktbeschreibung

Einbaulichtquelle für die Innenanwendung in allen Ausführungen außer Inox, welches auch zur Außenanwendung geeignet ist. Erhältlich mit LED-Leuchte der neuesten Generation, um den unterschiedlichen Signalansprüchen an Durchgängen und auf Treppen gerecht zu werden. Dank integriertem Farbdiffusor in verschiedenen Beleuchtungsfarben verfügbar. Der Lichtquellenkörper besteht aus Aluminium, Edelstahl oder bearbeitetem Bronze.

Betriebsgerät

Netzgerät für Konstantstrom nicht im Lieferumfang enthalten, aber als Zubehör erhältlich. Es ist möglich, bis zu 6 oder 15 G-O mit den empfohlenen Stromquellen zu installieren.

Zubehör

Verfügt über Einbauzubehör aus stranggepresstem Aluminium für Betonwände.

Zusatzinformationen

Schutzgrad IP65.
Schutzklasse III.
Auf normal entflammaren Oberflächen einsetzbar.

Qualitätszeichen

Das Gerät entspricht der europäischen technischen Norm EN60598-1 und den entsprechenden Zusatzregelungen.

Description

Embedded light fixture for indoor use in all its finishes, except stainless steel which is suitable for outdoor use. Available with next-generation LED light source, suitable for responding to diverse signalling needs on pathways or stairways. Available in different light shades, through coloured internal diffuser. Light body made of aluminium, stainless steel or machined bronze.

Power Supply

Constant voltage power supply not included, available as an accessory.
Up to 6 or 15 G-O can be installed with the recommended power sources.

Accessories

With extruded aluminium accessories for embedding in concrete walls.

Additional Information

IP65 protection grade.
Insulation class III.
Suitable for installation on normally inflammable surfaces.

Standard Compliance and Quality Marks

EN60598-1 European Technical Standards and any subsequent additions.



G-O

Light Source: Top LED 1,2W - 24V - 105 lm - 3000K/CRI 90

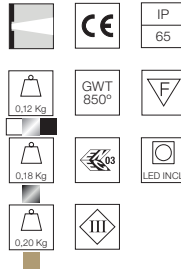
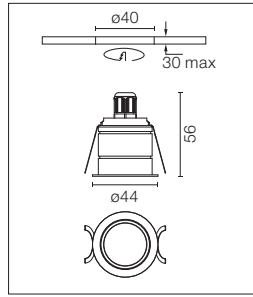

Halb eingebaute Orientierungsleuchte für Innenräume an Decke oder Wand. Ohne Netzgerät. 1000 mm Netzkabel im Lieferumfang enthalten.

Semi recessed signalling lamp for indoor use on ceiling/wall. Power supply not included. 1000 mm power cable included.

Equipment für Fernmontage an zugänglicher Stelle: passt nicht durch die Einbauöffnung der Leuchte, außer bei 60.9157.

Equipment for remote installation in an accessible place: it does not fit through the recessing hole of the luminaire, except 60.9157.

Empfohlene Netzgeräte / Recommended power supply*:
 Non Dimmable 110-240V 60.9157 (8W)
 Non Dimmable 220-240V 60.8703 (25W)
 Dali Controller 60.9678

* Siehe Treiberkapitel / Refer to the Drivers chapter

Für die DALI-Installation ist ein nicht dimmbares Gerät sowie eine DALI-Steuerung erforderlich.

For Dali installation, the non-dimmable kit and the Dali controller are needed.

Weisses Licht/White Light

- 09.3200.30A
- 09.3200.29A
- 09.3200.55A
- 09.3200.BZA
- 09.3200.ANA

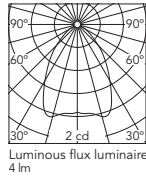

Beam Angle: 74°

h(m)	E(lx)	D(m)
1	2	1.51
2	1	3.03
3	0	4.54
4	0	6.06
5	0	7.57

Amber Licht/Amber Light

- 09.3201.30A
- 09.3201.29A
- 09.3201.55A
- 09.3201.BZA
- 09.3201.ANA

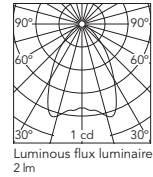

Beam Angle: 72°

h(m)	E(lx)	D(m)
1	1	1.46
2	0	2.92
3	0	4.38
4	0	5.85
5	0	7.31

Zubehör / Accessories

Element aus eloxiertem aluminium für den Einbau im Freien.

Housing for recessed installation made in anodized aluminium for outdoor installation.



08.8422.00

THEBLOCKOFLIGHT

DESIGNED BY KNUD HOLSCHER



LIGHT SOURCE
POWER LED
2,2W
154 lm
3000K/CRI 80

□ 01 Mattweiss
01 Matt White

■ 72 Grau
72 Grey

■ 04 Mattschwarz
04 Matt Black



Produktbeschreibung

Einbaulichtquelle für die Innen- und Außenanwendung (Schutzklasse IP65). Erhältlich mit LED-Leuchte der neuesten Generation, um den unterschiedlichen Signalansprüchen an Durchgängen oder auf Treppen gerecht zu werden.
Aluminiumblende in mattem Weiß, Grau oder mattem Schwarz.

Betriebsgerät

Inklusive nicht regulierbares Netzgerät: Konstantstrom 700 mA, 100/240V, 50/60Hz.

Zubehör

Verfügt über Einbauzubehör aus verzinktem Stahl für Betonwände.

Zusatzinformationen

Schutzgrad IP65.
Schutzklasse I.
Auf normal entflammaren Oberflächen einsetzbar.

Qualitätszeichen

Das Gerät entspricht der europäischen technischen Norm EN60598-1 und den entsprechenden Zusatzregelungen.

Description

Embedded light fixture designed for indoor or outdoor use (IP65 protection grade). Available with next-generation LED light source in response to diverse signalling needs on pathways or stairways.
Front made of aluminium with finish in matt white, grey or matt black.

Power Supply

Built-in, non-regulable constant current power supply of 100/240V, 50/60Hz. 700 mA current.

Accessories

Has galvanised steel accessories for embedding in concrete walls.

Additional Information

IP65 protection grade.
Insulation class I.
Suitable for installation on normally inflammable surfaces.

Standard Compliance and Quality Marks

EN60598-1 European Technical Standards and any subsequent additions.



THEBLOCKOFLIGHT

TheBlockofLight

Light Source: Power LED 2,2W - 154 lm - 3000K/CRI 80

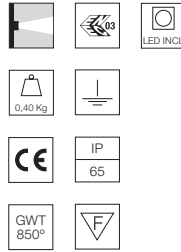
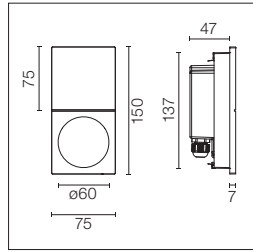

Halb eingebaute Orientierungsleuchte für Innen oder Außen. Nicht regulierbares Netzgerät mit 100-240 V, 50-60 Hz im Lieferumfang enthalten. Netzkabel mit 500 mm wird mitgeliefert.

Semi-recessed signalling lamp for indoor or outdoor use. Non-regulable 100-240V, 50-60Hz power supply and 500 mm power cable included.

□ 09.3310.01C

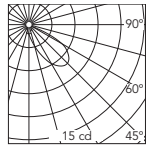

Beam Angle: 45°

h(m)	E(lx)	D(m)
1	15	1.79
2	4	3.58
3	2	5.37
4	1	7.16
5	1	8.95

Luminous flux luminaire 85 lm

■ 09.3310.72C

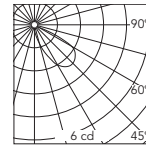

Beam Angle: 45°

h(m)	E(lx)	D(m)
1	6	1.85
2	2	3.70
3	1	5.55
4	0	7.40
5	0	9.25

Luminous flux luminaire 50 lm

■ 09.3310.04C

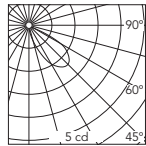

Beam Angle: 41°

h(m)	E(lx)	D(m)
1	5	1.64
2	1	3.28
3	1	4.92
4	0	6.55
5	0	8.19

Luminous flux luminaire 40 lm

Zubehör / Accessories

Hülse für den Einbau in Zement.

Can for embedding in concrete.



08.8423.00

3 - PHASEN - STROMSCHIENEN / THREE PHASE TRACKS

Phasen-Stromschienen

GLOBAL TRACK bietet viele Vorzüge für fortgeschrittene Installationen: die Verbindungselemente können elektrisch eingespeist werden und das Stromkabel unter den eleganten Zubehöraufhängungen verborgen werden. GLOBAL TRACK Beleuchtungsschienen werden für die einfache Montage an Decke und Wand oder den Einbau an Zwischendecken konzipiert. Die Schienen können in der entsprechend gewünschten Höhe angebracht werden. Weitere Vorteile des 3-phasen-Systems sind die hohen Leistungsaufnahmen und die Möglichkeit, für alle drei Phasen voneinander unabhängige Montagegruppen zu installieren. Dies erlaubt die Beleuchtung auch der anspruchsvollsten Ambientes.

Three Phase Track

GLOBAL TRACK offers benefits for advanced installations: the main connectors are feedable and the feeding cable can be hidden under the elegant suspension accessories. GLOBAL TRACK lighting tracks are designed for easy surface mounting on ceilings and walls, or recessed mounting in suspended ceilings. Lighting tracks can be suspended at any desired height. Other advantages of the three-circuit system are its high loading capacity and the possibility of forming independent fixture groups in all three circuits. This permits illumination of the most demanding environments.

Surface

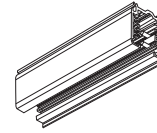
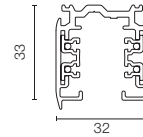

- 1000 mm
- 60.3101.11
 - 60.3101.29
 - 60.3101.14
- Dali Version
- 60.3101.11ADA
 - 60.3101.29ADA
 - 60.3101.14ADA

Surface Dali

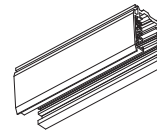
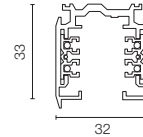
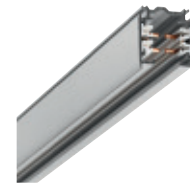

- 2000 mm
- 60.3102.11
 - 60.3102.29
 - 60.3102.14
- Dali Version
- 60.3102.11ADA
 - 60.3102.29ADA
 - 60.3102.14ADA

- 3000 mm
- 60.3103.11
 - 60.3103.29
 - 60.3103.14
- Dali Version
- 60.3103.11ADA
 - 60.3103.29ADA
 - 60.3103.14ADA

- 4000 mm
- 60.3104.11
 - 60.3104.29
 - 60.3104.14
- Dali Version
- 60.3104.11ADA
 - 60.3104.29ADA
 - 60.3104.14ADA



Recessed

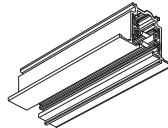
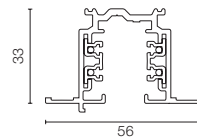
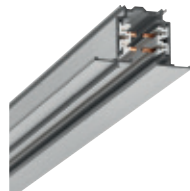

- 1000 mm
- 60.3810.11
 - 60.3810.29
 - 60.3810.14
- Dali Version
- 60.3810.11ADA
 - 60.3810.29ADA
 - 60.3810.14ADA

- 2000 mm
- 60.3820.11
 - 60.3820.29
 - 60.3820.14
- Dali Version
- 60.3820.11ADA
 - 60.3820.29ADA
 - 60.3820.14ADA

Recessed Dali

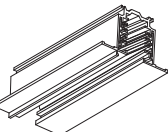
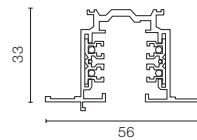
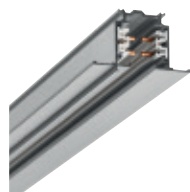

- 3000 mm
- 60.3830.11
 - 60.3830.29
 - 60.3830.14
- Dali Version
- 60.3830.11ADA
 - 60.3830.29ADA
 - 60.3830.14ADA

- 4000 mm
- 60.3840.11
 - 60.3840.29
 - 60.3840.14
- Dali Version
- 60.3840.11ADA
 - 60.3840.29ADA
 - 60.3840.14ADA



3 - PHASEN - STROMSCHIENEN / THREE PHASE TRACKS

Feste Stangen, um das Verformen der Profile (bei geraden Strukturen ohne Winkel) zu verhindern bzw. für Installationen, bei denen ein stabileres Befestigungssystem erforderlich ist.
Rigid rod to avoid the profile from tilting (rectilinear structures without corners) or to be installed in places where a more rigid fixing system is required.

Abhängestab mit Baldachin
1000 mm. Gewinde m6.   60.3014.11
60.3014.14



Suspension rod with 1000 mm rose.
m6 thread.

Verlängerung Abhängestab
1000 mm. Gewinde M6.   60.3097.11*
60.3097.14*



1000 mm suspension rod extension
set m6 thread.

Fijación a carril para cable de acero
con terminal roscado M6.   60.3008.11
60.3008.14

Attachment on track for steel cable
suspension with M6 thread end

Deckenhalterung mit Baldachin.
Ceiling fitting with rose.   60.3094.11
60.3094.14



Ceiling fitting with rose.

Befestigungspunkt an der Schiene
zur Stababhängung Gewinde m6.   60.3018.11
60.3018.14



Attachment on track for rod
suspension m6 thread.

Stahlkabel empfohlen, wenn die Struktur durch ihre Abmessungen ausgeglichen und stabil ist und eine oder mehrere Ecken aufweist, da bei diesen Strukturen die Schiene nicht kippt, obwohl das Gewicht der Leuchten nicht ausgeglichen ist.

A steel cable is recommended if the structure, because of its dimensions, is stable and includes one or more angles, since in these structures the track does not tilt even if the weight of the luminaries is not balanced.

Abhängeseil mit Bleigewicht ohne
Baldachin und Deckenhalterung.   1500 mm
60.3095.29

Lead-weighted wire without rose
and ceiling fitting.  3000 mm
60.3096.29

Befestigungsbügel der Schiene
an Decke/Wand oder zur
Seilabhängung mit Bleigewicht.   60.3025.11
60.3025.14
60.3025.29

Bracket for track fixing wall/ceiling or
suspension with lead-weighted wire.

Befestigungsbügel Schiene an Decke
Oder Wand.   60.3093.29

Bracket for fixing track to wall or
ceiling.

Befestigungspunkt an der Schiene
zur Seilabhängung.   60.3057.11
60.3057.29

Attachment on track for wire
suspension.

Komplette Wandhalterung
Ausleger 70mm.   60.3083.29

Complete wall support 70mm.

Schienenabdeckung L
3000mm.   60.3090.11

Track cover strip L 3000mm.

Abdeckbaldachin
Stromversorgung.   60.3092.11

Power supply rose cover.

Abdeckung für Einspeisung
Einbauschiene.   60.3053.11
60.3053.14
Dali Version

Cover for power supply
connectors recessed track.  60.3145.11
60.3145.14

Abdeckung Kreuzverbinder
Einbauschiene.   60.3091.11
60.3091.14
Dali Version

Cover for connectors.  60.3146.11
60.3146.14

* Endeinspeisung Rechts.
Live end right.   60.3038.11
60.3038.14
60.3038.12

Live end right.

 60.3038.11ADA
60.3038.14ADA
60.3038.12ADA

* Endeinspeisung Links.
Live end left.   60.3039.11
60.3039.14
60.3039.12

Live end left.

 60.3039.11ADA
60.3039.14ADA
60.3039.12ADA

* Einspeisung möglich / Feeding possible.

3 - PHASEN - STROMSCHIENEN / THREE PHASE TRACKS

Linearverbinder.



- 60.3044.11
- 60.3044.14
- 60.3044.12
- Dali Version
- 60.3044.11ADA
- 60.3044.14ADA
- 60.3044.12ADA

Straght connector.

* Kreuzverbinder.



- 60.3036.11
- 60.3036.14
- 60.3036.29
- Dali Version
- 60.3036.11ADA
- 60.3036.14ADA
- 60.3036.29ADA

Cross coupling.

* Linearverbinder mit
Einspeisungsmöglichkeit.



- 60.3043.11
- 60.3043.14
- 60.3043.29
- Dali Version
- 60.3043.11ADA
- 60.3043.14ADA
- 60.3043.29ADA

Mean connector.

Endkappe.



- 60.3016.11
- 60.3016.14
- 60.3016.12

Blind end.

* Eckverbinder 90°.



- Innen/Inside
- 60.3029.11
- 60.3029.14
- 60.3029.29
- Dali Version
- 60.3029.11ADA
- 60.3029.14ADA
- 60.3029.29ADA

Connector 90°.

DALI Flexibler Verbinder.



- 60.3037.11
- 60.3037.14
- 60.3037.29
- Dali Version

DALI flexible couple.

- 60.3037.11ADA
- 60.3037.14ADA
- 60.3037.29ADA

* Eckverbinder 90°.



- Aussen/Outside
- 60.3028.11
- 60.3028.14
- 60.3028.29
- Dali Version
- 60.3028.11ADA
- 60.3028.14ADA
- 60.3028.29ADA

Connector 90°.

Gelenkverbinder.



- 60.3046.11
- 60.3046.14
- 60.3046.29

Corner adjustable
connector.

Einbaugehäuse für
Einspeisungspunkt.



- 60.3022.11
- 60.3022.14

Recessed box for fix-point.

* T-Verbinder Innen.



- Rechts/Right
- 60.3047.11
- 60.3047.14
- 60.3047.29
- Dali Version
- 60.3047.11ADA
- 60.3047.14ADA
- 60.3047.29ADA

Connector T - inside.

Einspeisungspunkt an der
Decke.



- 60.3023.11
- 60.3023.14
- 60.3023.29

Fix-point.

- Links/Left
- 60.3048.11
- 60.3048.14
- 60.3048.29
- Dali Version
- 60.3048.11ADA
- 60.3048.14ADA
- 60.3048.29ADA

Biegewerkzeug.



60.3054

Lead bending key.

* T-Verbinder Aussen.



- Rechts/Right
- 60.3049.11
- 60.3049.14
- 60.3049.29
- Links/Left
- 60.3051.11
- 60.3051.14
- 60.3051.29

Conector T - outside.

* Einspeisung möglich / Feeding possible.

3 - PHASEN - STROMSCHIENEN / THREE PHASE TRACKS

Montageanleitungen der 3-Phasen-Schienen / Installation Instructions for the Three-Phase Tracks (3P+N+PE) Un400V, In 16A, 50Hz, Klasse I, IP 20

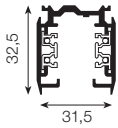

Die Position des Nulleiters ist mit der breiten Linie angezeigt.
The position of the neutral lead is shown by the thick line.

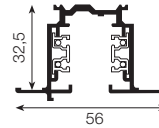

Die Position des Nulleiters ist mit der breiten Linie angezeigt.
The position of the neutral lead is shown by the thick line.

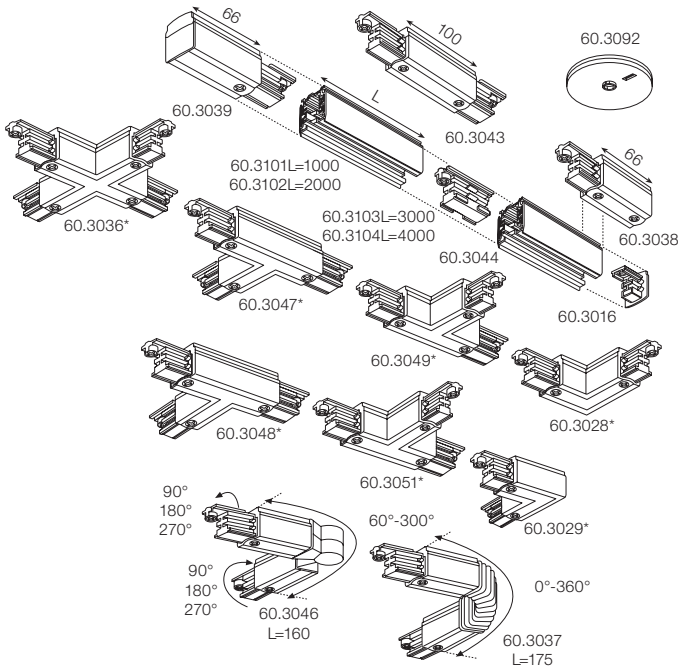

*Kann als Versorgungspunkt dienen / Can be used as a power supply point

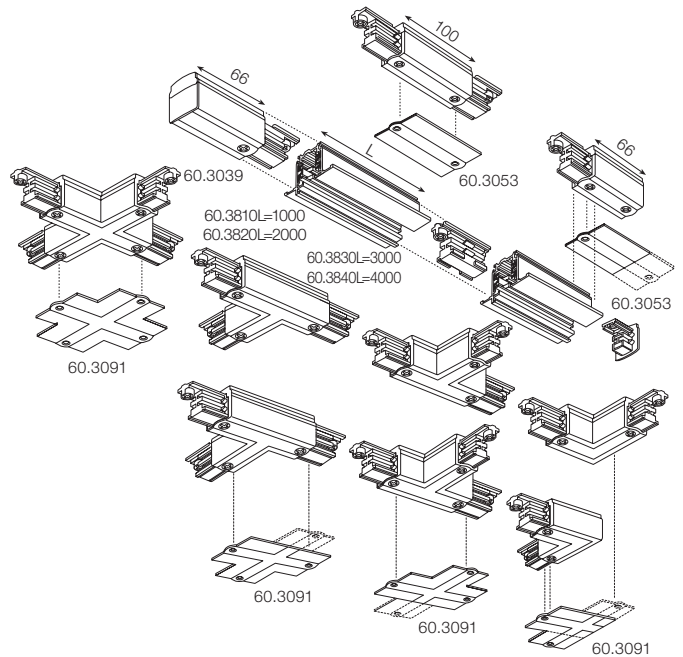

Montage in einer Nut in der Decke Mounting in a groove in the ceiling

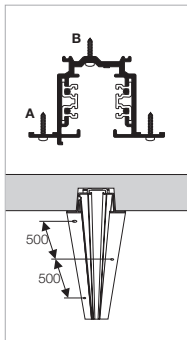

- schienen können durch die Flansche (A) oder durch den Schienenboden (B) befestigt werden.
- manner A: mit Schrauben \varnothing 3,0 - 4,5 im Abstand von 500mm.
- manner B: mit Flachkopfschrauben \varnothing 3,0, Stützabstand 1000mm-max. Belastung 20 kg / m.
- tracks can be fixed through the flanges (A) or through the track bottom (B).
- manner A: with screws \varnothing 3,0 - 4,5, at distance of 500mm.
- manner B: with flat head screws \varnothing 3,0, supporting distance 1000mm-max. load 20 kg/m.

Montage in abgehängten Decken Mounting in suspended ceilings

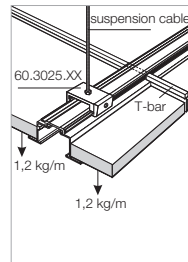

- mit Klammern 60.3025.XX.
- die Deckenplattenstruktur muss leicht zu demontieren sein, die Platten und die Schienen sind nicht aneinander befestigt.
- hängend bei max. 1000mm Abstand.
- plattenbelastung max. 1,2 kg / m pro Spurkranz.
- andere Formschieneaufhängelast max. 10 kg / hängender Abstand.
- with clamps 60.3025.XX.
- the ceiling plate structure must be easy to demount, the plates and the tracks are not fixed onto each others.
- hanging at max. 1000mm distance.
- plate load max. 1,2 kg/m per track flange.
- track hanging load max. 10 kg / hanging distance.

Zuschnitt der Beleuchtungsschienen / Cutting Track

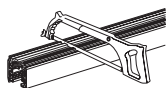

1 . Zuschnitt der schiene
1 . Cutting the track

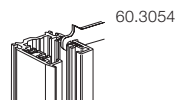

2 . Positionierung des Biegewerkzeuges in der schiene
2 . Positioning bending key in the track

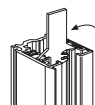

3 . Biegen der kabel
3 . Lead bending



4 . Gebogene kabel
4 . Bent leads

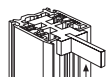

5 . Gebogene kabel kontrolle
5 . Bent leads control

3 - PHASEN - STROMSCHIENEN / THREE PHASE TRACKS

Anbringung der Verbinder / Connector Installation

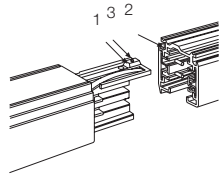

1 . Führungsfeder
1 . Guide flap

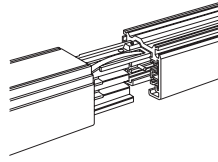

2 . Kanal
2 . Canal

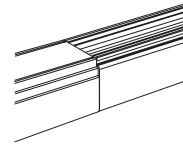

3 . Druckraster
3 . Pressure fixing

Schienebefestigung und Tragfähigkeit der Befestigung / Fixing the Track and Load Capacity

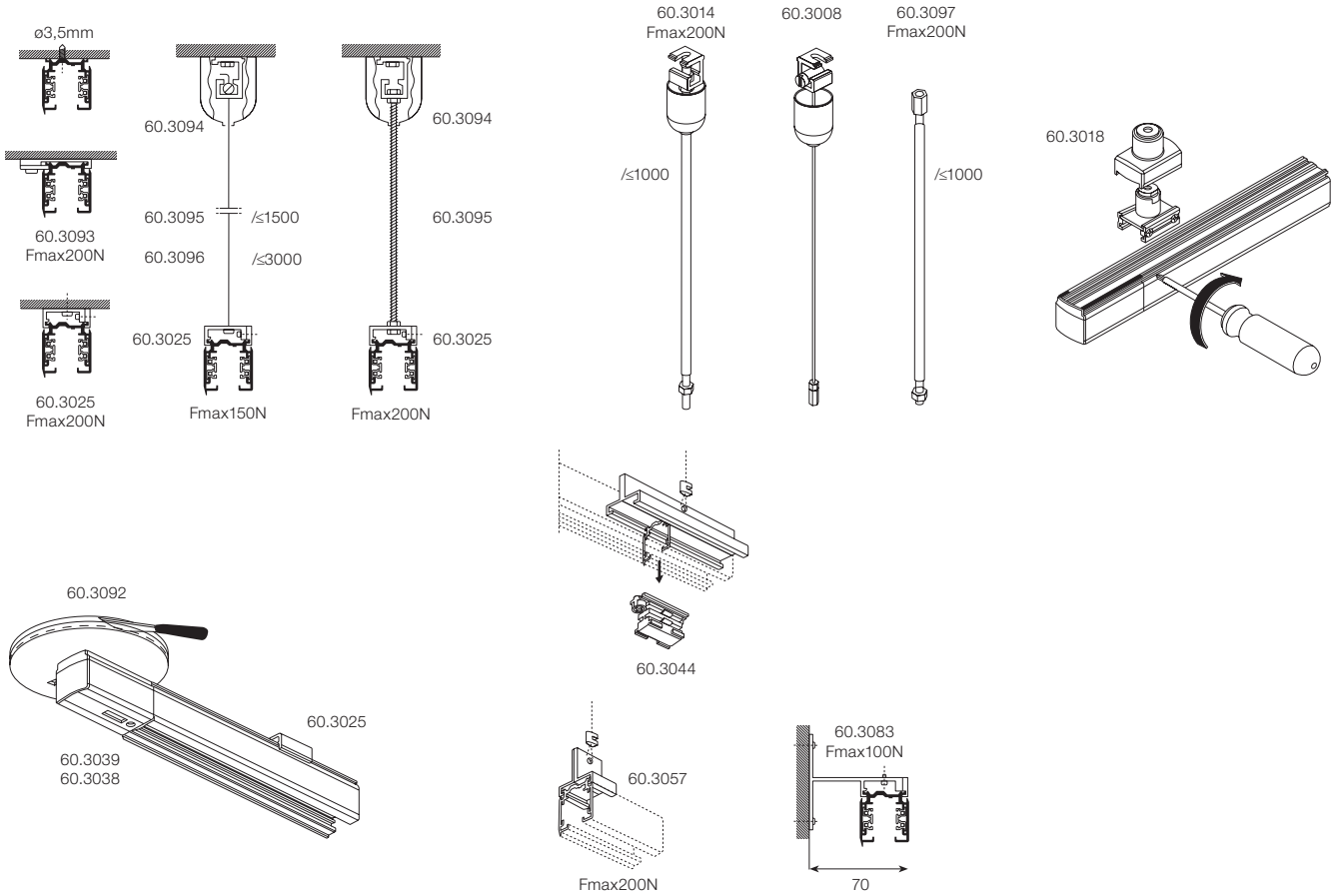

Befestigungsabstand und Belastbarkeit
 Empfohlener Verankerungsabstand L=1000mm.
 Die Schienen sind mit vorgebohrten Befestigungslöchern versehen.

Fastening Distance and Loading Capacity
 Recommended fastening distance L=1000mm.
 The tracks have fastening holes.

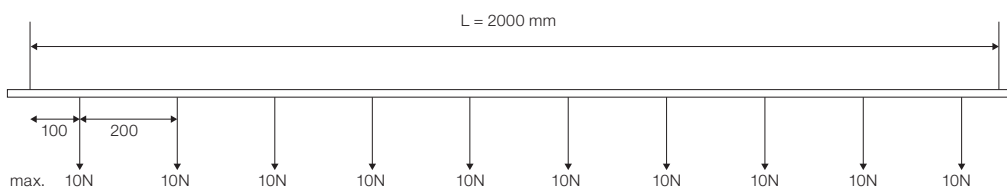
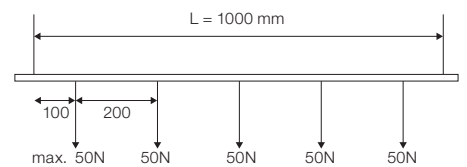
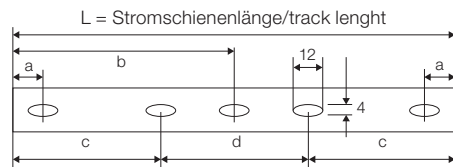

L mm	a mm	b mm	c mm	d mm
1000	250			
2000	250	1000		
3000	250		1000	1000
4000	250		1500	1000

3 - PHASEN - STROMSCHIENEN / THREE PHASE TRACKS

Anmerkungen zur Montage

Bei der Montage der Schiene ist zunächst zu bestimmen, auf welcher Seite die Erde liegen soll. Demnach sind die jeweiligen Zubehöre zu benutzen. In den folgenden Abbildungen zeigt die gestrichelte Linie die Position der Erdung an.

Abbildung 1. Längeder Schiene 1 Meter mit Stromanschluss (A) und entsprechender Buchse (B). Auf Abbildung 2 werden zwei unterschiedliche Anwendungen dargestellt. Die Erdung kann innerhalb oder ausserhalb vorgenommen werden. Es können (C) & (D) oder (E) & (F) verwendet werden.

Wenn die Erdung ausserhalb vorgenommen wird- dies wäre der erste Fall- so werden die Anschlüsse (C) mit (D) benutzt. Die Anschlüsse L sind dann für jede Ecke dieselben, also (H).

Wenn die Erdung innerhalb vorgenommen wird- was der zweite Fall wäre- so werden die Anschlüsse (E) mit (F). Der Anschluss L wäre in diesem Fall (I).

Planning Information

When you install the track, you have to choose on which side you wish to have the ridge. The ridge will tell you which accessories to use with. Have a look at the following figures where the dotted line indicates the ridge on the track.

If you have only one track, you can choose on which side you connect it and use the corresponding parts. Figure 1. Track of length 1 mt. with end feed (A) and its mirror image (B).

Figure 2. Shows two different cases. You will notice that the ridge can be either inside or outside the installation system. You can use respectively either (C) & (D) or (E) & (F).

If the ridge is outside, first case, you have to use the T connector (C) with its mirror image (D). The L connectors are then the same for each corner, (H). Inversely, if you have the ridge inside, second case, you will have to use the T connector (E) with its mirror image (F). The corresponding L connector is in this case (I).

1.

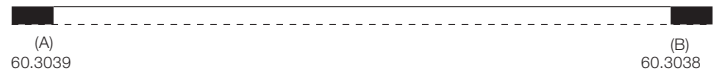

2.

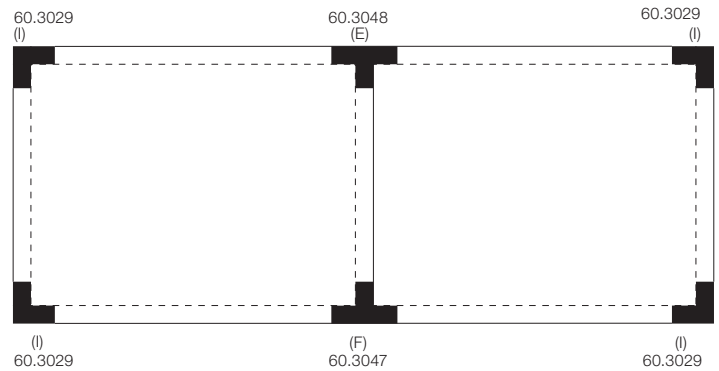
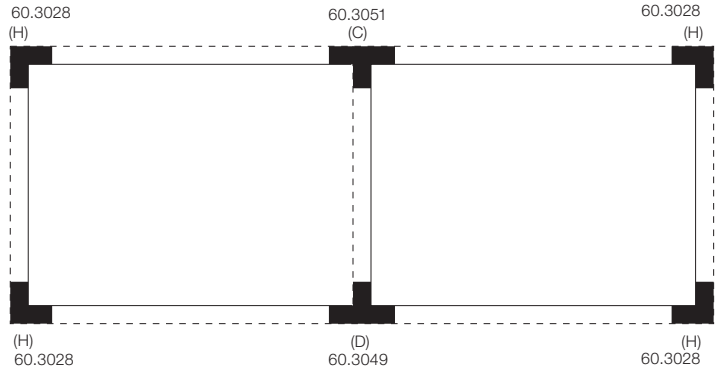

Beispiel / Example

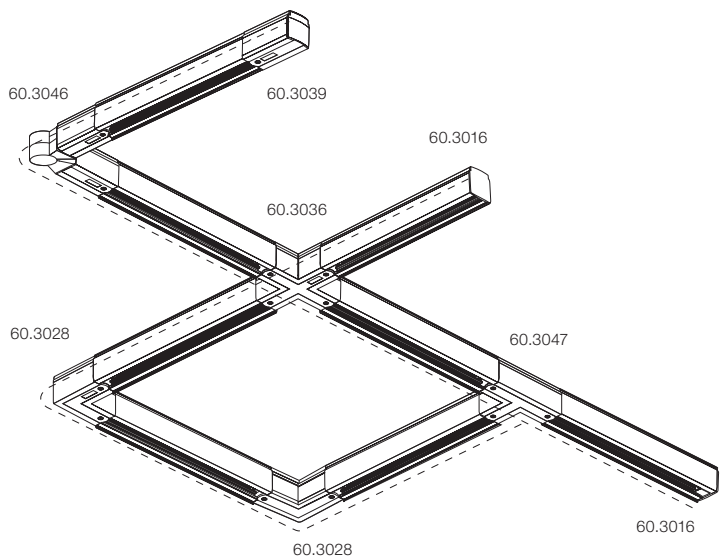

TREIBER / DRIVERS

Gleichstrom-Netzgerät für LED / Constant Current Power Supply for LED

Nicht regulierbares Konstantstrom-Netzgerät. 350mA - 17,5W / 500mA - 20W / 700mA - 20W - 220/240V - 50/60Hz.

Non dimmable continuous current power supply. 350mA - 17,5W / 500mA - 20W / 700mA - 20W - 220/240V - 50/60Hz.

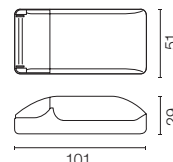

60.9312

Nicht regulierbares Konstantstrom-Netzgerät. 110/240V.

Non dimmable continuous current power supply. 110/240V.

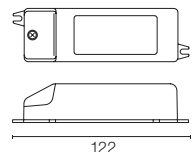

17W / 700 mA
*60.8655
20W / 500 mA
*60.8650
22W / 1050 mA
*60.8670

*110V - 12W

Nicht regulierbares Konstantstrom-Netzgerät mit 15-30W, 220/240V -50/60Hz mit wählbarer Stromversorgung über Schalter 350mA - 15W / 400mA - 17W / 450mA - 19W / 500mA - 22W / 550mA - 24W / 600mA - 26W / 650mA - 28W / 700mA - 30W.

Non dimmable continuous current power supply. 15-30W, 220/240V -50/60Hz with power current selected through adjustable switch. 350mA - 15W / 400mA - 17W / 450mA - 19W / 500mA - 22W / 550mA - 24W / 600mA - 26W / 650mA - 28W / 700mA - 30W.

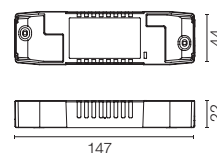

60.9592

Nicht regulierbares Konstantstrom-Netzgerät mit 25W, 110/240V - 50/60Hz mit wählbarer Stromversorgung über Schalter 350mA - 12W / 500mA - 15W / 700 mA - 25W.

Non dimmable continuous current power supply of 25W, 110/240V - 50/60Hz with power current selected through adjustable 350mA - 12W / 500mA - 15W / 700 mA - 25W switch.

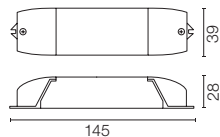

60.8437

110V - max 18W

Nicht regulierbares Konstantstrom-Netzgerät mit 110/240V 32W, mit wählbarer Stromversorgung über Schalter 350 mA-17W /500 mA-24W /700 mA-32W /900 mA - 32W.

Non dimmable continuous current power supply of 110/240V 32W, with power current selected through adjustable 350 mA-17W /500 mA-24W /700 mA-32W /900 mA - 32W. switch.

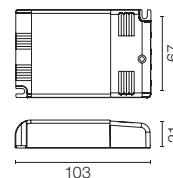

60.9233

110V - max 15W

Nicht regulierbares Konstantstrom-Netzgerät mit 15-20W, 110/240V - 50/60Hz, mit wählbarer Stromversorgung über Schalter 350 mA-15W /500 mA/ /550 / 700 / 850 mA / 900 mA - 20W.

Non dimmable continuous current power supply of 15-20W, 110/240V - 50/60Hz, with power current selected through adjustable 350 mA-15W /500 mA/ /550 / 700 / 850 mA / 900 mA - 20W switch.

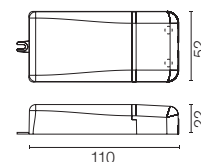

60.8911

110V - max 15W

Konstantstrom-Netzgerät mit 25W, 110/240V - 50/60Hz mit wählbarer Stromversorgung über Schalter 350 mA-18W / 400 mA - 21W / 500mA - 25W /600mA - 30W /700/750/900 mA - 32W regulierbar. 1-10V oder Druckdimmer, erfordert nicht mitgelieferte Steuerkabel.

Continuous current power supply of 25W, 110/240V - 50/60Hz with power current selected through adjustable 350 mA-18W / 400 mA - 21W / 500mA - 25W /600mA - 30W /700/750/900 mA - 32W switch. 1-10V or push dimming, synchronisation cables not included.

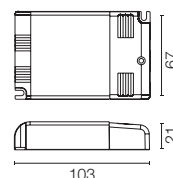

60.8533

110V - max 15W

Konstantstrom-Netzgerät mit 25-50W, 110/240V - 50/60Hz mit wählbarer Stromversorgung über Schalter 350mA - 25W /500mA - 35W/ 700mA - 50W /750mA - 54W /900/ 1050 mA - 60W regulierbar. Dalí 2, 0/1-10V oder Druckdimmer, erfordert nicht mitgelieferte Steuerkabel.

Continuous current power supply of 25-50W, 110/240V - 50/60Hz with power current selected through adjustable 350mA - 25W /500mA - 35W/ 700mA - 50W /750mA - 54W /900/ 1050 mA - 60W switch. Dalí 2, 0/1-10V or push dimming, synchronisation cables not included.

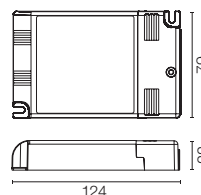

60.8530

110V - max 40W

TREIBER / DRIVERS

Gleichstrom-Netzgerät für LED / Constant Current Power Supply for LED

Konstantstrom-Netzgerät mit 13-20W, 110/240V - 50/60Hz mit wählbarer Stromversorgung über Schalter 300 mA - 15W / 350 mA - 18W / 400/450/500/550/600/650/700/750/800/850/900 mA - 15W., regulierbar. 0/1-10V oder Druckdimmer, erfordert nicht mitgelieferte Steuerkabel.

Continuous current power supply of 13-20W, 110/240V - 50/60Hz with power current selected through adjustable 300 mA - 15W / 350 mA - 18W / 400/450/500/550/600/650 /700/750/800/850/900 mA - 15W. switch. 0/1-10V or push dimming, synchronisation cables not included.

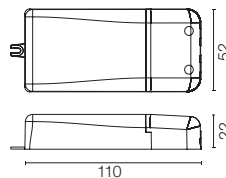

60.9188

110V – max 15W

Konstantstrom-Netzgerät mit 30-50W, 110/240V - 50/60Hz mit wählbarer Stromversorgung über Schalter 300mA - 34W /350 mA - 39W /400 mA - 45W /450 mA - 50W /500 mA - 56W /550/600/650/700mA - 60W, regulierbar. Dali 1, Dali 2, 0/1-10V oder Druckdimmer, erfordert nicht mitgelieferte Steuerkabel.

Continuous current power supply of 30-50W, 110/240V - 50/60Hz with power current selected through adjustable 300mA - 34W /350 mA -39W /400 mA - 45W /450 mA - 50W /500 mA - 56W /550/600/650/700mA - 60W switch. Dali1, Dali 2, 0/1-10V or push dimming, synchronisation cables not included.

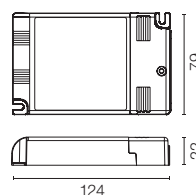

60.8837

110V – max 40W

Konstantstrom-Netzgerät mit 12-20W, 110/240V - 50/60Hz mit wählbarer Stromversorgung über Schalter 350mA - 17W / 400mA - 19W / 450 / 550 / 600 / 700mA - 20W regulierbar Dali 1 und Dali 2.

Continuous current power supply of 12-20W, 110/240V - 50/60Hz with power current selected through adjustable 350mA - 17W / 400mA - 19W / 450 / 500 / 550 / 600 / 700mA - 20W dimmable Dali 1 and Dali 2.

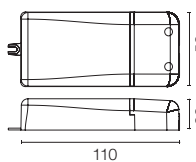

60.9222

110V – max 15W

Konstantstrom-Netzgerät mit 10-20W, 110/240V - 50/60Hz mit wählbarer Stromversorgung über Schalter 250 mA - 10W / 350 mA - 15W /400 mA - 17W /450 mA - 19W /500/550/600/700 mA - 20W, regulierbar per Dali 1.

Continuous current power supply of 10-20W, 110/240V - 50/60Hz with power current selected through adjustable 250 mA - 10W / 350 mA - 15W /400 mA - 17W /450 mA - 19W /500/550/600/700 mA - 20W, Dali 1 switch.

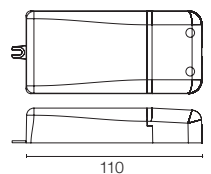

60.8847

110V – max 15W

Konstantstrom-Netzgerät mit 13-20W, 110/240V - 50/60Hz mit wählbarer Stromversorgung über Schalter 250 mA - 13W / 350 mA - 18W /400/450/500/550/600/700/800/900 mA - 20W, regulierbar 1-10V oder Druckdimmer.

Continuous current power supply of 13-20W, 110/240V - 50/60Hz with power current selected through adjustable 250 mA - 13W / 350 mA - 18W /400/450/500/550/600/700/800/900 mA - 20W, 1-10V or push dimming.

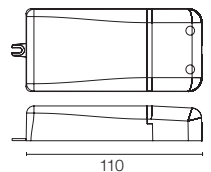

60.9208

110V – max 15W

Konstantstrom-Netzgerät mit 20-40W, 110/240V - 50/60Hz mit wählbarer Stromversorgung über Schalter 350 mA -18,5W / 400 mA - 21W / 500 mA - 26,5W / 600 mA - 31,5W /650 mA -34,5W /700 mA -37W /750 mA - 39,5W /800/850/900/950/1000/1050/1200 mA - 40W, regulierbar. Dali 1, 0/1-10V oder Druckdimmer, erfordert nicht mitgelieferte Steuerkabel.

Continuous current power supply of 20-40W, 110/240V - 50/60Hz with power current selected through adjustable 350 mA -18,5W / 400 mA - 21W / 500 mA - 26,5W / 600 mA - 31,5W /650 mA -34,5W /700 mA -37W /750 mA - 39,5W /800/850/900/950/1000/1050/1200 mA - 40W switch. Dali 1, 0/1-10V or push dimming, synchronisation cables not included.

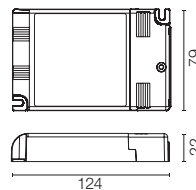

60.9276

Konstantstrom-Netzgerät mit 13-42W, 220/240V - 50/60Hz mit wählbarer Stromversorgung über Schalter 300 mA - 13W / 350 mA - 15W / 400 mA - 18W / 450 mA - 20W / 500 mA - 22W / 550 mA - 24W / 600 mA - 27W / 650 mA - 29W / 700 mA - 31W / 750 mA - 32W / 800 mA - 33W / 850 mA - 35W / 900 mA -38W / 950 mA - 40W / 1000/1050 mA - 42W.

Continuous current power supply of 13-42W, 220/240V - 50/60Hz with power current selected through adjustable 300 mA - 13W / 350 mA - 15W / 400 mA - 18W / 450 mA - 20W / 500 mA - 22W / 550 mA - 24W / 600 mA - 27W / 650 mA - 29W / 700 mA - 31W / 750 mA - 32W / 800 mA - 33W / 850 mA - 35W / 900 mA -38W / 950 mA - 40W / 1000/1050 mA - 42W switch.

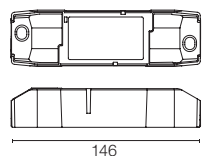

60.9162

TREIBER / DRIVERS

Gleichstrom-Netzgerät für LED / Constant Current Power Supply for LED

Konstantstrom-Netzgerät 6W, 100V / 14W, 240V - 50/60Hz mit Stromzufuhr 500 mA.

Continuous current power supply of 6W, 100V / 14W, 240V - 50/60Hz with 500 mA supply voltage.

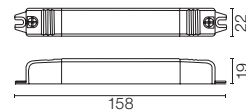

60.8880

Konstantstrom-Netzgerät mit 7,2-24W, 220/240V - 50/60Hz mit wählbarer Stromversorgung über Schalter 150 mA - 7,2W /200 mA - 9,5W /250 mA - 12W /300 mA -14,5W /350 mA -17W/400 mA - 19,5W /450 mA -21,5W /500 mA - 24W regulierbar. Mains oder Druckdimmer.

Continuous current power supply of 7,2-24W, 220/240V - 50/60Hz with power current selected through adjustable 150 mA - 7,2W /200 mA - 9,5W /250 mA - 12W /300 mA -14,5W /350 mA -17W/400 mA - 19,5W /450 mA -21,5W /500 mA - 24W switch. Mains or push dimming.

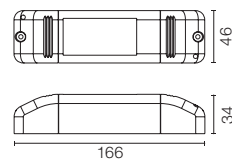

60.9421

Konstantstrom-Netzgerät 10W, 110V / 12W, 240V - 50/60Hz mit Stromzufuhr 700 mA.

Continuous current power supply of 10W, 110V / 12W, 240V - 50/60Hz with 700 mA supply voltage.

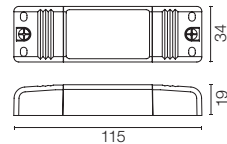

60.8529

Konstantstrom-Netzgerät 18W, 220/240V - 50/60Hz mit Stromzufuhr 450 mA mains dimming, trailing edge.

Continuous current power supply of 18W, 220/240V - 50/60Hz with 450 mA supply voltage mains dimming, trailing edge.

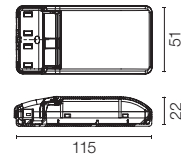

60.9268

Konstantstrom-Netzgerät mit 32W, 230/240V - 50/60Hz mit wählbarer Stromversorgung über Schalter 350mA - 17W / 500mA - 24W / 700/ 750 mA - 32W, regulierbar über Dimmer, Mains Dimmer oder Druckdimmer an Profilhinterkante bzw. Profilvorderkante.

Continuous current power supply of 32W, 230/240V - 50/60Hz with power current selected through adjustable 350mA - 17W / 500mA - 24W / 700/ 750 mA - 32W switch by trailing and leading edge dimming, mains dimming or push dimming.

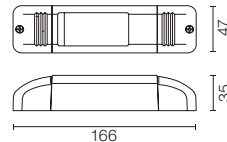

60.8534

Elektronischer Transformator für LED mit beständiger Spannung (24V). 8W, 220/240V, 50/60Hz.

Electronic transformer with constant voltage (24V) for LED. 8W, 220/240V, 50/60Hz.

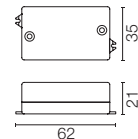

60.8079

Elektronischer Transformator für LED mit beständiger Spannung (24V). 8W, 110/240V, 50/60Hz.

Electronic transformer with constant voltage (24V) for LED. 8W, 110/240V, 50/60Hz.

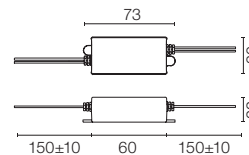

60.9157

Konstantstrom-Netzgerät 10W, 100-240V - 50/60Hz mit nicht regulierbarer Stromzufuhr 500 mA.

Constant voltage supply source of 10W, 100-240V - 50/60Hz with non adjustable 250 mA supply voltage.

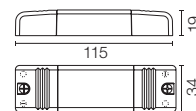

60.9744

Konstantstrom-Netzgerät 20W, 100-240V - 50/60Hz mit regulierbarer Stromzufuhr 500 mA.

Constant voltage supply source of 20W, 100-240V - 50/60Hz with adjustable 250 mA supply voltage.

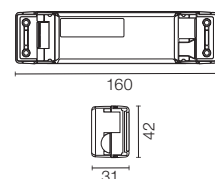

0-10V
60.9405
Dali
60.9601

TREIBER / DRIVERS

Gleichstrom-Netzgerät für LED / Constant Current Power Supply for LED

Nicht dimmbare Dauerstromversorgung von 220/240V - 50/60Hz mit Leistungsstrom, der über einen Schalter mit 200 mA - 8,5W / 300 mA - 13W / 350 mA - 15W / 400 mA - 17,5W / 450 mA - 19,5W / 500 mA - 22W einstellbar ist.

Non dimmable continuous current power supply of 220/240V - 50/60Hz with power current selected through adjustable with switch 200 mA - 8,5W / 300 mA - 13W / 350 mA - 15W / 400 mA - 17,5W / 450 mA - 19,5W / 500 mA - 22W.

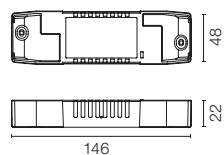

60.9160

Konstantstrom-Netzgerät 0-10V-Dimmung, 220/240V - 50/60Hz, 200mA - 20W.

Continuous current power supply, 0-10V dimmable, 220/240V - 50/60Hz, 200mA - 20W.

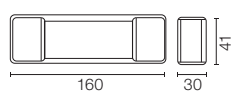

60.9483

Konstantstrom-Netzgerät Dali 2-Dimmung, 220/240V - 50/60Hz, 200mA - 20W.

Continuous current power supply, dimmable Dali 2, 220/240V - 50/60Hz, 200mA - 20W.

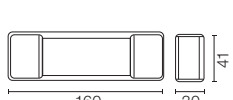

60.9604

Konstantstrom-Netzgerät 0/1-10V-Dimmung, 220/240V - 50/60Hz, 300 mA - 16W / 350 mA - 18W / 400 mA - 21W / 500 mA - 27W / 600 mA - 32W / 650 mA - 35W / 700/750/800/900/1000/1050 mA - 36W.

Continuous current power supply, 0/1-10V dimmable, 220/240V - 50/60Hz, 300 mA - 16W / 350 mA - 18W / 400 mA - 21W / 500 mA - 27W / 600 mA - 32W / 650 mA - 35W / 700/750/800/900/1000/1050 mA - 36W.

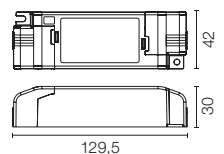

60.9439

Konstantstrom-Netzgerät Dali 2-Dimmung, Druckdimmer 240V - 50/60Hz mit regulierbarer Stromzufuhr 300mA - 16W / 350mA - 18W / 400mA - 21W / 500mA - 27W / 600mA - 32W / 650 mA - 35W / 700/750/800/900/1000/1050 mA - 36W.

Continuous current supply source of 240V - 50/60Hz with dimmable Dali 2, push dimming. 300mA - 16W / 350mA - 18W / 400mA - 21W / 500mA - 27W / 600mA - 32W / 650 mA - 35W / 700/750/800/900/1000/1050 mA - 36W.

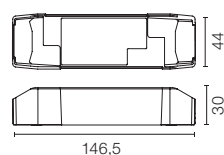

60.9186

Konstantstrom-Netzgerät Casambi-Dimmung, 220/240V - 50/60Hz, 300mA - 16W / 350mA - 18,5W / 400mA - 21,5W / 450 mA - 24W / 500mA - 27W / 600mA - 32W / 650 mA - 35W / 700 mA - 36W / 750/800/900/1000/1050/1200 mA - 38W.

Continuous current power supply, dimmable Casambi, 220/240V - 50/60Hz, 300mA - 16W / 350mA - 18,5W / 400mA - 21,5W / 450 mA - 24W / 500mA - 27W / 600mA - 32W / 650 mA - 35W / 700 mA - 36W / 750/800/900/1000/1050/1200 mA - 38W.

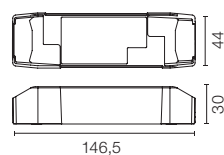

60.9207

Mains Konstantstrom Speisequelle, regulierbar 1-10V, regulable Mains, leading & trailing edge 220/240V - 50/60Hz, 500mA - 10W.

Continuous current power supply, 1-10V, regulable Mains, leading & trailing edge 220/240V - 50/60Hz, 500mA - 10W.

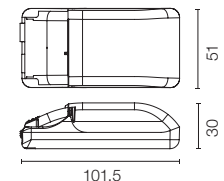

60.9411

Mains Konstantstrom Speisequelle, regulierbar, leading & trailing edge 220/240V - 50/60Hz, 300mA - 14W / 350 mA - 17W / 400 mA - 19W / 450/500/600/650/700/750/800/900 mA - 20W.

Continuous current power supply, Mains dimming, leading & trailing edge 220/240V - 50/60Hz, 300mA - 14W / 350 mA - 17W / 400 mA - 19W / 450/500/600/650/700/750/800/900 mA - 20W.

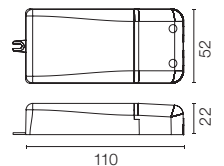

60.9467

TREIBER / DRIVERS

Stromversorgung mit Konstanter Spannung für LED / Constant Voltage Power Source for LED

LED-Netzteil für den Ferneinbau im Verteiler 24V/240W. 100/240V.

LED power supply source for remote installation in 24V/240W electric control panel. 100/240V.

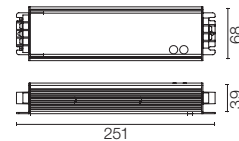

60.8268

Elektronischer Transformator für LED mit beständiger Spannung (24V) – 100/240V.

Electronic transformer with constant voltage (24V) for LED. 100/240V.

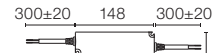

25W
60.8703



60W
60.9089

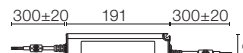

120W
60.9407

Elektronischer Transformator für LED mit beständiger Spannung (24V) – 60W. 100/240V. Für unabhängige Verwendung.

Electronic transformer with constant voltage (24V) for LED. 60W. 100/240V. For independent use.

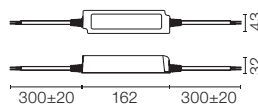

60.8515

LED-Netzteil für den Ferneinbau im Verteiler 24V/200W. Um Überlastproblemen vorzubeugen, empfiehlt sich der Einbau eines Netzteils für jeweils 185W. 100/240V.

LED power supply source for remote installation in 24V/200W electric control panel. To avoid problems of overload it is recommended to install a power source every 185W. 100/240V.

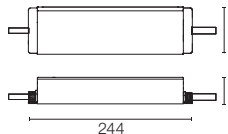

60.9352

12V Elektronischer Transformator / 12V Electronic Transformer

12V Elektronischer Transformator. 220/240V, 50/60Hz mit trailing edge Dimmer.

12V electronic transformer. 220/240V, 50/60Hz. Adjustable by means of "leading and trailing edge".



35-105W
60.9424
20-70W
60.9398

Prüfen Sie die Kompatibilität mit LED-Retrofit-Lampen / Please check compatibility with Retrofit LED lamps.

12V Elektronischer Transformator. 230/240V, 50-225W.

12V electronic transformer. 230/240V, 50-225W.

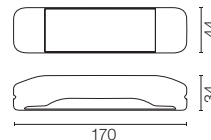

60.8364

Prüfen Sie die Kompatibilität mit LED-Retrofit-Lampen / Please check compatibility with Retrofit LED lamps.

12V Konventioneller Transformator / 12V Conventional Transformer

12V Ferromagnetischer Transformator. 230V, 50/60Hz. IP67. Primärleitung 75 cm, Sekundärleitung 145cm.

12V conventional transformer. 230V - 50/60Hz. IP67. Primary wire: 75 cm, secondary wire: 145 cm.

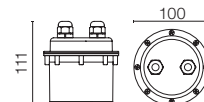





50W
60.8311



TREIBER / DRIVERS

Ref	L max(m) 1.5mm ²	L max(m) 2.5mm ²
60.8079	5	N/A
60.8268	2	3,5
60.8311	5	8,5
60.8364	1	1,5
60.8437	20	50
60.8515	5	N/A
60.8529	20	50
60.8530	10	15
60.8533	10	15
60.8534	10	15
60.8629	50	50
60.8650	50	50
60.8654	20	50
60.8655	20	50
60.8656	20	50
60.8670	20	30
60.8689	50	50
60.8703	5	N/A
60.8837	10	15
60.8847	10	15
60.9208	10	15
60.8880	50	50
60.8911	20	50
60.9089	5	N/A
60.9157	5	N/A
60.9160	10	15
60.9162	20	30
60.9186	10	15
60.9188	10	15
60.9207	10	15
60.9222	10	15
60.9233	20	50
60.9268	15	15
60.9276	10	15
60.9312	20	50
60.9352	2,5	4
60.9744	6	15
60.9398	2	2
60.9405	6	15
60.9407	5	10
60.9411	5	10
60.9421	20	50
60.9424	2	2
60.9439	2,5	4
60.9467	10	15
60.9483	2,5	4
60.9592	10	15
60.9601	20	50
60.9604	2,5	4



LEUCHTQUELLE / LIGHT SOURCES



	Wattage (W)	Color T ^a (K)	Voltage (V)	Reference
 QT-14 CLEAR	18	2770	230	60.6616
	28	2770	230	60.6617
	42	2700	230	60.6618
 BASE G9 230V				



	Angle	Wattage (W)	Color T ^a (K)	Voltage (V)	Reference
 HI PAR 51	25°	50	3000	230	60.6722
	40°	50	3000	230	60.6723
	60°	50	3000	230	60.6724
 BASE GX10 230V					



	Wattage (W)	Color T ^a (K)	Voltage (V)	Reference
 QT-14 ES	20	2900	230	RF19264
	33	2900	230	RF18863
 BASE G9 230V				

	Wattage (W)	Color T ^a (K)	Voltage (V)	Reference
 TC-DEL	18	2700	230	60.6213
	18	3000	230	60.6256
	18	4000	230	60.6257
	26	2700	230	60.6214
	26	3000	230	60.6258
	26	4000	230	60.6259
 BASE G24q 230V				

	Wattage (W)	Color T ^a (K)	Voltage (V)	Reference
 QT-12	35	3000	12	60.6300
	50	3000	12	60.6303
	75	3000	12	60.6304
	90	3000	12	60.6305
	100	3000	12	60.6306
	35	2900	12	60.6404 ^{IRC}
	50	3000	12	60.6399 ^{IRC}
 BASE GY6.35 12V				

	Wattage (W)	Color T ^a (K)	Reference	
 T5 FH	14	3300	60.6500	
	21	3300	60.6503	
	21	4000	60.6504	
	28	3000	60.6506	
	28	4000	60.6507	
	35	3300	60.6509	
	35	4000	60.6510	
	 BASE G5 230V			

	Wattage (W)	Color T ^a (K)	Voltage (V)	Reference
 QT-9	10	3000	12	60.6301
	20	3000	12	60.6302
 BASE G4 12V				

	Wattage (W)	Color T ^a (K)	Reference
 T5 FQ	24	3300	60.6512
	24	4000	60.6513
	39	3300	60.6515
	39	4000	60.6516
	54	3000	60.6518
	54	4000	60.6519
	54	5000	60.6520
	80	3300	60.6521
	80	4000	60.6522
	80	5000	60.6523
 BASE G5 230V			

LED ARRAY

Steuerung **Bessere Optische Steuerung**

Das LED-Reihenmodul besitzt eine Oberfläche mit hoher Lichtdichte, die es mithilfe von Reflektoren ermöglicht, das Licht auf sehr effiziente Weise zu kontrollieren. Es kann eine große Vielfalt an Öffnungswinkeln erzielt und somit nahezu jeder Anwendung entsprochen werden.

Control **Greater Optical Control**

The LED Array module has a high-density light surface that allows the light to be effectively controlled through reflectors. A wide variety of opening angles can be obtained, thereby catering for any application.

Kein Mosaikeffekt **Weißes Licht ohne Mosaikeffekt**

Die LED-Reihe erzeugt dank ihrer Konfiguration ein gleichförmiges Weißschema ohne Farbvariationen. Darüber hinaus verändert sich während der während Nutzungsdauer des Moduls weder sein außerordentlicher Lichtfluss noch die Farbtemperatur.

No Pixellation **White Light without Pixellation**

Due to its configuration, the LED Array achieves a uniform standard of whites with no change in colour. In addition, during the useful life of the module, an exceptional maintenance of the luminous flow and colour temperature is obtained.

Kostenreduzierung **Verringerung der Betriebskosten**

Dank der langen Nutzungsdauer mit einem Mindestlichtfluss von 70% werden die Instandhaltungskosten mit dieser LED-Lösung stark reduziert. Der Energieverbrauch verringert sich im Vergleich zu herkömmlichen Lichtquellen um bis zu 75 %.

Cost Reduction **Reduction in Operating Costs**

With this LED solution, there is a drastic reduction in maintenance costs due to its long useful life with a minimum luminous flow of 70 %. The energy consumed is reduced by 75 % compared to traditional lighting sources.

Kommerzielle Anwendung **Lichtquelle für die Kommerzielle Anwendung**

Der Lichtfluss enthält keine Infrarot- oder UV-Strahlen, die Schäden an der Kleidung verursachen und für das vorzeitige Altern von Nahrungsmitteln verantwortlich sein können. Die reduzierte Wärmebildung im Lichtstrahl sorgt für eine Verringerung der Kosten für den Einsatz von Klimaanlage.

Retail Application **Light Source for Retail Application**

The luminous flow contains no IR or UV radiation, which cause damage to clothing or the premature spoiling of food. The elimination of heat in the light beam is transformed into a reduction in air conditioning costs.

Reflektoren **Leuchtleistung**

Das LED-Reihenmodul ist keine Punktlichtquelle. Das Licht wird über die Harzfläche der LED-Matrix ausgegeben. Dieser Aufbau hat Einfluss auf die Berechnung der Leuchtkraft und die Steuerung des Öffnungswinkels der LEDs. Aus diesem Grund sind Reflektoren die geeignetste Methode zur Steuerung der Leuchtleistung.

Die Reflektoren können aus metallisiertem Thermoplast bestehen, da die Lichtquelle keine thermischen Ansprüche stellt. Die thermoplastische Bauweise sorgt für mehr Flexibilität im Design und die reflektierende Oberflächenform mit einer Leistung von 90 % kann auf eine Art und Weise optimiert werden, die bei herkömmlichen Reflektoren aus Aluminium nicht durchführbar wäre.

Der Öffnungswinkel kann 20° bis etwa 60° betragen.

Reflectors **Light Performance**

The LED module is not a point source. The light is emitted through the LED matrix resin area. This construction has an influence when making light calculations and controlling the LED opening angle. As a result, the best way to perform this light control is using reflectors.

These reflectors may be made of metallic thermoplastic material since there is no thermal demand on the light source. As they can be made of thermoplastic, there is greater flexibility in their design and the reflecting surface can be optimised with non-viable forms with traditional aluminium reflectors, with a performance of 90 %.

Opening angles of between approximately 20° and 60° can be obtained.

POWER LED

Lichtstrahl **Geschlossener Lichtstrahl**

Da es sich um eine Punktlichtquelle handelt, muss die optische Steuerung über Linsen erfolgen. Die optische Steuerung ermöglicht die Reduzierung des Lichtstrahls bis auf sehr kleine Winkel. Deshalb eignet sich eine Power LED besonders gut als Lichtquelle für Anwendungen, die eine hohe Lichtdichte voraussetzen.

Light Beam **Closed Light Beam**

Due to the fact that the light comes from a point source, optical control must be carried out using lenses. This optical control allows for the reduction of the light beam to very closed angles. For this reason, this is the most appropriate light source in applications which require a high light density.

Design **Designfreiheit**

Power LEDs werden auf elektronischen Platten montiert. Diese elektronischen Platten können in einer unendlichen Vielfalt an Maßen und Formen hergestellt werden, weshalb das gesamte Design der Lichtquelle (elektronische Platte + LED + Linsen) höchst flexibel und frei gestaltbar ist. Durch diese Flexibilität hebt sie sich von den herkömmlichen Lichtquellen ab.

Design **Freedom of Design**

The power LEDs are mounted on electronic board. These electronic boards can be designed in many different sizes and shapes, so that the complete light source design (electronic board + LED + Lenses) is extremely flexible and has great freedom. This flexibility makes it different from traditional light sources.

Farbe **Große Palette an Farbtemperaturen**

Power LEDs werden dank ihrer diskreten Eigenschaften in einer großen Vielfalt von Farbtemperaturen angeboten. Es werden sogenannte BINs, Bereiche des chromatischen Spektrums, festgelegt, innerhalb derer die LEDs hinsichtlich der gewählten Farbtemperatur garantiert über eine bestimmte minimale chromatische Variation verfügen.

Colour **Wide Range of Colour Temperatures**

The power LEDs are discreet, and can be selected in a wide range of colour temperatures. Bins are established (chromatic spectrum ranges) in which it is guaranteed that the LEDs have a minimum chromatic change with respect to the colour temperature selected.

TOP LED

Lichtstrahl **Diffuses Licht**

Eignen sich dank ihrer Bauweise ausgezeichnet für Anwendungen, in denen keine Lichtführung erforderlich ist, wie indirekte Beleuchtung oder Lichtquellen mit eingebautem Diffusor.

Light Beam **Diffuse Light**

Given their geometry, they are excellent for applications that have no directed light requirements, such as indirect light or luminaires.

Stromversorgung **Spannung 24V**

Aufgrund ihrer kompakten Größe und der unkomplizierten Stromversorgung ermöglichen die "Top LED" beim Entwerfen einer gedruckten Schaltung eine Vielzahl an unterschiedlichen Lösungen. Ihre einfache Stromversorgung über Konstantstromquellen mit 12/24 V, die Möglichkeit von Parallelanschluss und -installation sowie die Option, gruppierte und ungleichmäßige Designs zu erstellen, machen sie zu perfekten Kandidaten, wenn es gilt, eine Lichtquelle zu entwickeln, die sich nicht im Rahmen traditioneller Beleuchtungslösungen bewegt.

Power Supply **Voltage 24V**

Given their compact dimensions and simple power supply, the "Top LED" offer dozens of different solutions for designing a printed circuit. Their easy power supply using constant 12/24V voltage supplies with possible assemblies and connections in parallel, together with the possibility of creating grouped and irregular designs, make them the perfect candidate when a light source far from the conventions set by traditional light sources is necessary.

Farbe **Große Palette an Farbtemperaturen**

Ebenso wie die "Power LED" sind auch die "Top LED" in einer umfangreichen, das gesamte Farbenspektrum umfassenden Farbtemperaturpalette verfügbar. Die festgelegte Auswahl wird durch ihren Bin-Code definiert, der ihre Gleichförmigkeit gewährleistet.

Colour **Wide Range of Colour Temperatures**

The "Top LED" like the "Power LED" are available in a large range of colour temperatures distributed throughout the entire chromatic spectrum. The selection made will be defined by its bin guaranteeing its homogeneity in it.

REMOTE PHOSPHOR LED

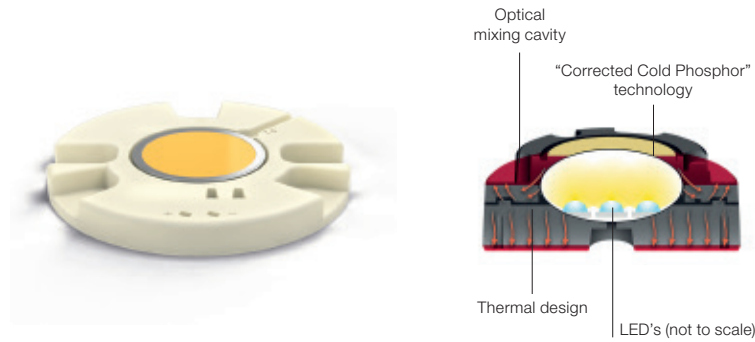

Einheitlichkeit Der Farbe und Chromatische Homogenität

Einheitlichkeit der Farbe und chromatische Homogenität. Das Phosphor-LED-Fernmodul ist in einem Farbtemperaturbereich von 2700K, 3000K und 4000K erhältlich. Jede Farbtemperatur ist exakt auf der Kurvenlinie der Planckian Black Body Locus positioniert, um für makelloses weißes Licht zu sorgen. Auf der MacAdam-Ellipse besitzen die LEDs eine Toleranz von 1x2 und mit ANSI C78.377 einen besseren Spezifikationswert.

Consistency Colour and Chromatic Homogeneity

The remote phosphor LED module is available in a colour temperature range of 2700K, 3000K and 4000K. Each of these colour temperatures is exactly positioned in the BBL (Black Body Locus) to guarantee perfect white light. The LEDs selection tolerance is 1x2 in the MacAdam ellipse, improving the ANSI C78.377 specification.

Gleichförmigkeit Des Lichtstrahls

Bei Halogenlampen bzw. LED-Reihen können aufgrund der natürlichen Ungleichförmigkeit der Lichtquelle Lichtvariationen auf einer beleuchteten Fläche entstehen. Das Phosphor-Fernmodul besitzt eine gleichförmige Lichtemissionsfläche, was sich in seinem perfekten Lichtstrahl ohne Schatten und Lichtvariationen widerspiegelt.

Uniform Light Beam

Halogen lamps or LED Arrays may suffer changes in light on an illuminated surface, due to the non-uniformity of the light source. The remote phosphor module has a uniform light-emitting surface that is reflected in a perfect beam of light without shadows or changes in colour.

Reproduktion Ist Hoch Chromatisch

In der Version "Artist" wird durch die adäquate Auswahlkombination für die LEDs und durch die Eigenschaften des Phosphors ein Farbwiedergabeindex (CRI) von mehr als 95 erreicht. Das Modul wurde optimiert, um ein ausgezeichnetes Ergebnis mit satten Farben zu erzielen. Für Rot liegt der Wert bei über 90. Diese Zahlen übersteigen nicht nur die Resultate anderer LED-Lösungen, sondern übertreffen sogar noch die herkömmlicher Leuchtstoff- oder Metallhalogenidlampen.

Reproduction High Chromatic

With the "Artist" version; through the correct combination of the LEDs selection and phosphor specifications, a CRI above 95 is obtained. This module has been optimised to obtain excellent results in the most saturated colours. For the red, a value above 90 has been obtained. These numbers not only surpass those of other LED solutions, but improve the results of traditional fluorescent or metal halogenide lamps.

COLOUR RENDERING CHART

A comparison between the Phosphor LED (Artist Series) and other lighting sources
Note: 2700K and 4000K perform similarly

	Ra	R1	R2	R3	R4	R5	R6	R7	R8	R9	R10	R11	R12	R13	R14	R15
Artist Series XTM	98	98	99	98	98	98	97	98	98	96	99	98	88	98	98	98
Typical IR coated Halogen Dichroic	98	98	99	99	99	98	98	99	97	92	97	98	97	98	99	97
Typical Compact Metal Halide	82	90	94	69	82	81	81	87	71	27	59	62	55	93	78	88
Typical Compact Fluorescent	87	91	93	86	91	89	90	88	70	17	76	91	81	93	92	81

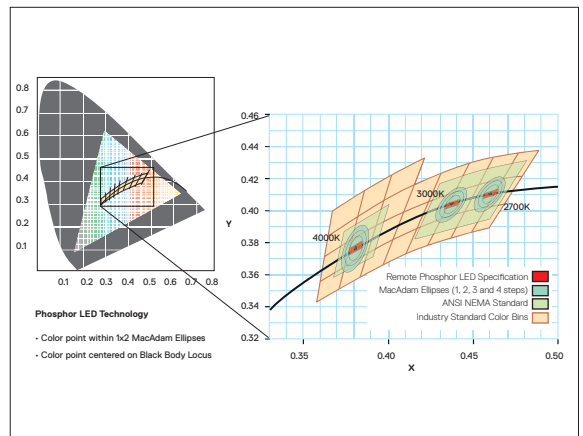

Independent measurements by University College London

PIKTOGRAMME / PICTOGRAPHY

Schutzart Degree of Protection



Schutzgrad gegen feste Fremdkörper und Wasser.

Protection degree offered by the fixture to the ingress of solids and liquids.



0 Ungeschützt.
1 Fremdkörper grösser als 50 mm.
2 Geschützt gegen feste Fremdkörper grösser als 12 mm.
3 Geschützt gegen feste Fremdkörper grösser als 2,5 mm.
4 Geschützt gegen feste Fremdkörper grösser als 1 mm.
5 Staubgeschützt.
6 Staubgeschützt.

0 No protection.
1 Protected against solid bodies over 50 mm in diameter.
2 Protected against solid bodies over 12 mm in diameter.
3 Protected against solid bodies over 2,5 mm in diameter.
4 Protected against solid bodies over 1 mm in diameter.
5 Protected against dust.
6 Fully protected against dust.

1. Kennziffer: Schutz gegen Eindringen fester Körper.

1st figure: protection against penetration by solid bodies.



0 Ungeschützt.
1 Geschützt gegen senkrecht fallendes Tropfwasser.
2 Geschützt gegen senkrecht fallendes Tropfwasser.
3 Geschützt gegen schräg fallendes Sprühwasser mit einem Winkel bis zu 60°.
4 Geschützt gegen Spritzwasser.
5 Geschützt gegen Strahlwasser.
6 Geschützt gegen schwere See.
7 Geschützt gegen Untertauchen.
8 Geschützt gegen dauerhaftes Untertauchen.



0 No protection.
1 Protected against drops of water falling vertically.
2 Protected against drops of water at a max. inclination of 15 degrees.
3 Protected against drops of water at a max. inclination of 60 degrees.
4 Protected against splashed of water.
5 Protected against jets of water.
6 Protected against waves.
7 Protected against immersion.
8 Protected against long term immersion.

2. Kennziffer: Schutz gegen Eindringen von Wasser.

2nd figure: protection against penetration by water.



Piktogramme Pictography



Geräte zur Montage an oder in normal entflammaren Flächen geeignet.

Luminaire with builtin power packs or transformers, suitable for mounting directly onto normally inflammable surfaces.



Konventionelles Vorschaltgerät.

Conventional Ballast.



Besteht Prüfung mit Glühdraht (Glow Wire Test) bei 850°C laut Norm IEC 60695-2-10.

Passes Glow Wire Test at 850°C according to standard IEC 60695-2-10.



Ausschließlich für die Verwendung von Wolfram-Halogenlampen oder Halogen-Metaldampflampen mit eigenem Schutzschirm entwickelte Leuchten.

Luminaires designed to exclusively use wolfram halogen lamps or metal halide lamps with own protection screen.

KLASSIFIKATION & ZULASSUNG / CLASSIFICATION & HOMOLOGATIONS

Leuchenschutzklassen Luminaires Classification



Class I

Leuchten, bei denen der Schutz gegen elektrischen Schlag nicht nur auf der Basisisolierung beruht, sondern bei denen zusätzliche Sicherheitsvorkehrungen getroffen werden. Alle berührbaren unter Spannung stehenden Teile müssen an einen Schutzleiter (Erdungsanschluß) angeschlossen sein.

Luminaire in which protection against electrical shocks is not just based on the basic insulation but also on an additional safety precautions consisting of connecting the accessible conductive parts to a safety conductor (earth).



Class II

Leuchten, bei denen der Schutz gegen elektrischen Schlag nicht nur auf der Basisisolierung beruht, sondern die über zusätzliche Sicherheitsvorkehrungen durch doppelte Isolierung verfügen ohne Erdungsanschluß.

Luminaire in which protection against electrical shocks is not just based on the basic insulation but also on an additional safety precautions consisting of double reinforced insulation without conductive parts to a safety conductor (earth).



Class III

Leuchten, bei denen der Schutz gegen elektrischen Schlag durch den Anschluß an eine Schutzkleinspannung erreicht wird; es dürfen keine höhere Spannung produziert werden. Eine Leuchte der Klasse III darf niemals einen Schutzleiteranschluß enthalten.

Luminaire in which protection against electrical shocks is based on the very low safety supply voltage and no voltages are produced higher than this. A Class III luminaire must never be provided with earthing.

Zulassungen Homologations



Alle im Rahmen dieses Programms produzierten und präsentierten Leuchten wurden konform zu der Europäischen Norm EN 60 598 hergestellt und entsprechen damit den Anforderungen der Richtlinie 73/23 EWG (Niederspannungsrichtlinie). Der Herstellungsprozess garantiert ebenfalls die Konformität zur Richtlinie 89/336 EWG welches die elektromagnetische Verträglichkeit betrifft. Alle dem Anwendungsbereich der oben genannten Richtlinien unterliegenden Produkte enthalten das CE Zeichen, welches die Konformität zu den jeweiligen Anforderungen kennzeichnet.

All lamps manufactured and illustrated in this catalog comply with European Standard EN 60 598 and consequently meet the requirements set forth in Directive 73/23 EEC (Low Voltage Directive). They also comply with Directive 89/336 covering electromagnetic compatibility. All products falling under the scope of the above-mentioned Directives bear the CE mark as proof of their compliance with the respective requirements.



Das ENEC-Zeichen auf dem Produkt gewährleistet über die Zertifizierung durch eine benannte Stelle die Einhaltung der europäischen Normen sowie zuverlässige Organisations- und Produktionssysteme. Dieses Prüfzeichen steht für unser Engagement und gibt die beste Garantie in Bezug auf Sicherheit und Qualität unserer Produkte.

The ENEC mark on the product stands for the compliance of European Standard as well as a trustworthy organisation and product system and is guaranteed by an accredited certification body. This agreed mark stands for our engagement and represents the best guarantee in security and quality matter of our products.



Der spanische Verband für Normen und Zertifizierung AENOR, bescheinigt, daß das von Antares Iluminación, S. A. angewendete Qualitätssicherungssystem den Anforderungen der Normen UNE-EN ISO-9001 - Qualitätssicherungssystem - entspricht.

The Spanish Association for Standards and Certification AENOR, certifies that quality assurance system adopted by Antares Iluminación, S.A. complies with the requirements of the standard UNE-EN ISO-9001 Quality Systems.



Die Zertifizierungsstelle QCERT S.A.S. bewertet unter Berücksichtigung der geltenden nationalen und internationalen Bestimmungen die Konformität unserer Produkte für deren Vermarktung in Kolumbien. Diese Zertifizierung der Produkte ermöglicht es Herstellern und Händlern, ihren Absatzmarkt zu vergrößern und einen Wettbewerbsvorteil zu erlangen, der über die Grenzen des lokalen Marktes hinausgeht, und so den Handel auf internationalem Niveau zu steigern.

The QCERT S.A.S. Certification Body evaluates the conformity of our products to enable their placement on the Colombian market while taking into account the current national and international regulations. This product certification allows manufacturers and marketers to expand their markets and gain a competitive advantage that can transcend the boundaries of the local market while enhancing international trade.



Das von IECEE entwickelte CB-Zertifizierungssystem basiert auf den internationalen IEC-Standards und ist in Saudi-Arabien, Argentinien, Australien, Österreich, Bahrain, Belgien, Weißrussland, Brasilien, Bulgarien, Kanada, China, Kolumbien, Kroatien, Dänemark, Vereinigte Arabische Emirate, Finnland, Frankreich, Deutschland, Japan, Griechenland, Indien, Indonesien, Irland, Israel, Italien, Kenia, Libyen, Malaysia, Mexiko, Norwegen, Neuseeland, Niederlande, Pakistan, Polen, Portugal, Vereinigtes Königreich, Tschechische Republik, Republik aus Korea, Rumänien, Russland, Serbien, Singapur, der Slowakei, Slowenien, Spanien, den Vereinigten Staaten, Südafrika, Schweden, der Schweiz, Thailand, der Türkei, der Ukraine, Ungarn und Uruguay anerkannt.

Created by IECEE, the CB certification system based on the IEC International Standards is recognized in Saudi Arabia, Argentina, Australia, Austria, Bahrain, Belgium, Belarus, Brazil, Bulgaria, Canada, China, Colombia, Croatia, Denmark, United Arab Emirates, Finland, France, Germany, Japan, Greece, India, Indonesia, Ireland, Israel, Italy, Kenya, Libya, Malaysia, Mexico, Norway, New Zealand, Netherlands, Pakistan, Poland, Portugal, United Kingdom, Czech Republic, Republic of Korea, Romania, Russia, Serbia, Singapore, Slovakia, Slovenia, Spain, United States, South Africa, Sweden, Switzerland, Thailand, Turkey, Ukraine, Hungary and Uruguay.

Photometrische Daten Photometric Data

Im Laufe der Zeit ist die Anzahl der visuellen Inputs, denen der Mensch ausgesetzt ist, erheblich angewachsen. Etwa 75% der Informationen über unsere Umgebung, die wir ausarbeiten, scheinen heutzutage über die Augen aufgenommen zu werden, die ähnlich wie eine Kamera funktionieren, denn auch sie nehmen das von den Objekten in einem bestimmten Raum ausgestrahlte oder reflektierte Licht auf. Das bedeutet, dass die in unserem Hirn ausgearbeiteten Informationen stark von dem Helligkeitsniveau, dem Lichttyp und der Art der Raumausleuchtung abhängen.

Mit dem hier präsentierten photometrischen Material (insbesondere mit dem Berechnungsprogramm) möchten wir den Licht - Designern das erforderliche Material zur Verfügung stellen, das sie zur Realisierung von Beleuchtungsprojekten benötigen, die den aktuell geltenden Vorschriften der Norm EN 12464-1 entsprechen, was die richtige Lichtverteilung, den Sehkomfort, die höchstmögliche Leistung und damit auch den geringsten Energieverbrauch betrifft. Für eine volle Nutzung des Berechnungsprogramms ist eine eingehende Kenntnis der verwendeten Produkte absolut erforderlich.

Die Norm EN 12464-1

Diese Norm legt die beleuchtungstechnischen Kriterien für eine bestmögliche Ausleuchtung der einzelnen Räume im Innenbereich fest, insbesondere am Arbeitsplatz, auch an Bildschirmarbeitsplätzen, und schreibt Durchschnittswerte für Beleuchtungsstärke E_m , Farbwiedergabe R_a und Sehkomfort UGR vor.

Genormter Index der Direktblendung UGR (Unified Glare Rating).

Das UGR klassifiziert die Blendstörung, die die Beleuchtungsanlage in einem Innenraum verursacht unter Berücksichtigung des Leuchtkörpertyps, der Spiegelungscharakteristiken, der Raumdimension und der Position des Beobachters. Für einen CAD Arbeitsplatz z.B. schreibt die EN 12464-1 folgende Werte vor: $E_m = 500 \text{ lx}$, $R_a = 80$, $UGR \leq 19$.

Graphische Darstellung der Charakteristiken von Lichtemissionen

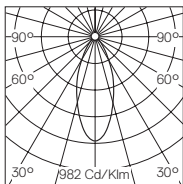

Die Verteilung der von einem Leuchtkörper ausgestrahlten Lichtstärken wird in einem Polarkoordinatendiagramm mit einer oder mehreren Lichtstärkeverteilungskurven C dargestellt, die die Lichtquelle im Schnitt durch das Lichtbarzentrum durchqueren. Die Raumpunkte und Lichtstärkenwerte werden von einem System von Kugelkoordinaten erfasst (C, γ, I). Die Kurven, die die Endpunkte der Lichtstärken-Vektoren auf den C-Kurven vereinigen, nennen sich Lichtstärkeverteilungskurven (LVK) oder Ausgabeindikator.

Die Anzahl der erforderlichen Kurven C ist in den CIE Empfehlungen vorgeschrieben und ebenfalls in die Europäische Norm über Lichtstärkeverteilungsmessungen und deren graphische Darstellung aufgenommen (CEN 13 032-1).

Bei rotationssymmetrischen Lichtquellen kann die Lichtstärkeverteilung durch eine einzige Lichtstärkeverteilungskurve charakterisiert werden. Bei allen anderen Lichtquellen sind zumindest eine Querkurve (C0-180) und eine Längskurve (C90-270) erforderlich.

Bei Leuchten, die mehrere, geometrisch identische Leuchtmittel, allerdings mit unterschiedlichem Lichtstrom enthalten können, wird generell angenommen, dass das Polardiagramm der Lichtstärkenverteilung für einen idealen Lichtstrom von 1.000 Lumen dargestellt, und demnach in cd/klm ausgedrückt wird.

Für Lichtquellen mit integrierter Optik sind die in diesem Katalog angegebenen Höchstwerte der Lichtstärken absolut (cd) und nicht auf einen normalisierten Lichtstrom von 1.000 Lumen bezogen, während die gleichen Werte bei anderen Lichtquellen einem idealen Lichtstrom von 1.000 Lumen (cd/klm) entsprechen.

Für LED-Produkte mit elektronischer Steuerung und Kühlkörper, sowie solche, die Netzanschluss oder Stromzufuhr durch ein DC-Netzteil benötigen, einschließlich kompletter LED-Leuchten mit nicht austauschbaren LED-Modulen, wird bei der Testmethode LM-79 die absolute Fotometrie zur direkten Messung des Gesamtlichtstroms für jede einzelne Konfiguration herangezogen.

Tatsächliche Lichtverteilung und Lichtintensität werden direkt an der kompletten Leuchte gemessen.

With the passing of time, we have been exposed to a rising number of visual impacts. It is currently estimated that about 75% of the information we process when relating to our surroundings is received through our eyes, which work very much like a camera, through the light that is emitted or reflected from objects in a given environment. This means that the information processed by the brain is heavily reliant on the level and type of light, and how this environment is illuminated.

The photometric documentation that has been prepared (especially through the calculation program) aims to provide lighting designers with the material they need to develop lighting projects that comply with the EN 12464-1 standard now in force, in terms of sufficient light distribution, visual comfort, maximum lighting efficiency and consequently, the lowest possible energy consumption. In order to make the most of the calculation program, it is essential to have all the necessary information on the products to be used.

EN 12464-1 Standard

Sets the technical lighting requirements that satisfy the needs of indoor visual performance, especially in workplaces, even when visual display terminals are used, by prescribing the average illuminance values E_m , color rendering R_a , visual comfort UGR.

UGR (Unified Glare Rating)

Classifies the discomfort glare caused by an indoor lighting system, taking into account the kind of luminaires, the reflecting features and size of the rooms, the position of the observers.

For example, for CAD workstations, EN 12464-1 standards set $E_m = 500 \text{ lx}$, $R_a = 80$, $UGR \leq 19$.

Diagram of the Characteristics of Light Output

Luminous intensity distribution is presented in the form of a polar plot of one or more C planes that cross-section the luminaire, passing through its light center of gravity. The planes and the intensity are shown by means of a system of spherical coordinates (C, γ, I). The curves that join the ends of the intensity vectors on a C plane are called photometric curves or output indicators.

The number of C-section planes is prescribed by CIE recommendations, and is referred to in the European Standards on photometric measurements and data presentation (CEN 13 032-1).

For revolving or symmetrical luminaires, light output is shown as a single curve. In all the other cases, the diagram shows the horizontal (C0-180) and longitudinal (C90-270) planes at least.

For luminaires that can be fitted with light sources that are geometrically the same but with different luminous fluxes, it is generally accepted that the polar plot shows an ideal luminous flux of 1,000 lumen and is therefore expressed in cd/klm .

For light sources that include reflectors, the maximum luminous intensity values provided in this catalogue are absolute (cd) and do not refer to a standard 1,000 lm flux.

For other sources, the same values correspond to an ideal 1,000 lm (cd/klm) flux.

For LED-based products incorporating control electronics and heat sinks, products requiring only line voltage or DC power supply, including complete LED luminaires with no replaceable integrated LED sources, the LM-79 test method uses absolute photometry to directly measure total lumen output for a particular configuration.

The real distribution of light and light intensity are measured directly for the complete luminaire.

	E(lx/Klm)	D(m)
	h(m)	11°
1	4918	0.20
2	1229	0.40
3	546	0.60
4	307	0.80
5	197	0.99

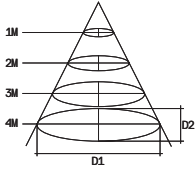

Beleuchtungsstärke (durch das Symbol E ausgedrückt)

Die mittlere Lichtintensität, in Lux (lx) ausgedrückt, auf einer Fläche ist der Quotient zwischen dem Lichtstrom, in Lumen (lm) ausgedrückt, der auf eine Fläche trifft, und der Abmessung (m^2) der Fläche selbst. Je nach den Erfordernissen kann man die horizontalen Lichtintensitäten berechnen (z.B. auf dem Schreibtisch: Zum Lesen), die vertikalen (Beleuchtung eines Sportplatzes: Damit man die Sportler sehen kann) oder die halbzylinderförmigen (Straßenbeleuchtung: Damit man eine entgegenkommende Person erkennen kann). In manchen Fällen, z.B. wenn es sich um Spots oder Leuchten mit integriertem Reflektor handelt, werden die Leistungen vereinfacht in Tabellen gezeigt, so genannten "Lichtkegeln", die sowohl die Durchschnitts- und Höchstwerte der Lichtintensitäten, als auch die Durchmesser des Leuchtflecks im Verhältnis zu den Abständen der beleuchteten Fläche zur Lichtquelle zeigen. Der Winkel an der Spitze des Lichtkegels gibt die Öffnung des Strahlenbündels der Lichtquelle an, genauer gesagt der Winkel, den der Lichtstärken-Vektor anzeigt, wenn seine Leistungsflussdichte die Hälfte der maximalen Lichtintensität übersteigt. Die Lichtintensität wird in Lux pro 1.000 lm ausgedrückt (lx/klm). Für Lichtquellen mit integrierter Optik sind die mittleren und Höchstwerte der Lichtintensitäten absolut, während sie bei anderen Lichtquellen einem idealen Lichtstrom von 1.000 lm entsprechen.

Isolux

Bei einer Beleuchtungsanlage können die Ergebnisse der photometrischen Messungen auf einer beleuchteten Fläche in Form von "Isolux-Diagrammen" graphisch dargestellt werden, d.h. mit Linien, die die Punkte mit gleicher Lichtintensität verbinden. Die Isolux-Diagramme erlauben eine rasche, wenn auch nicht absolut präzise Einschätzung des Durchschnittswertes und der Gleichmäßigkeit der Lichtintensität.

CIE 62/98/100/100/74
DIN A50
UTE 0.47C+0.00T
CIBSE TM5 B23/2/B22

Photometrische Klassifizierung von Leuchten

Ausgehend von den Charakteristiken der Lichtstromverteilung und von verschiedenen Daten über die Lichtstromabgabe einer Leuchte nach oben und nach unten, sowie von dem Verhältnis zwischen den einzelnen Leistungen ist es möglich, eine Leuchte je nach ihrer Konformität zu verschiedenen Empfehlungen und Standardkriterien zu klassifizieren: CIE, DIN 5040, UTE, und CIBSE LG3.

CIE

Darstellung der Lichtstromverteilung einer Leuchte im Inneren von Lichtkegeln mit festgelegten Öffnungswinkeln; der letzte Wert der Serie gibt die Gesamtleistung der Leuchte an.

Die Leuchten werden auf der Basis von fünf Zahlen klassifiziert (CIE Indexe)

$$N_1 = F_1/F_4 \quad N_2 = F_2/F_4 \quad N_3 = F_3/F_4 \quad N_4 = F_4/F_5 \quad N_5 = F_5/F_5 = \text{Leistung}$$

Dabei ist:

F_1 ist die Lichtstromabgabe im Kegel des Raumwinkels $\pi/2$, Scheitelwinkel 83°

F_2 ist die Lichtstromabgabe im Kegel des Raumwinkels π , Scheitelwinkel 120°

F_3 ist die Lichtstromabgabe im Kegel des Raumwinkels $3\pi/2$, Scheitelwinkel 151°

F_4 ist die Lichtstromabgabe im Kegel des Raumwinkels 2π , Scheitelwinkel 180°

F_5 ist die Lichtstromabgabe im Kegel des Raumwinkels 4π , Scheitelwinkel 360°

F ist die installierte Lichtstromabgabe.

Illuminance (shown as E)

The average illuminance expressed in lux (lx) on a surface is the quotient resulting from the luminous flux, expressed in lumen (lm), on the surface and the dimension (m^2) of the surface itself. Depending on the need, the illuminance value can be horizontal (e.g. on a desk: for reading), vertical (illumination of a sports fields: to see the players), semi-cylindrical (urban fittings: to see who is coming towards us).

In some cases, for example when using spotlights or lamps with a reflector, the performance features are simply shown by means of tables called "light cones" showing both the average and maximum illuminance values, as well as the diameter of the luminous spot, in relation to the distance of the plane from the luminaire. The vertex angle of the light cone is the luminaire's beam, that is, the angle formed by the intensity vector when its module is greater than half of the maximum intensity.

Illuminance is expressed in lux per 1,000 lm (lx/klm). For light sources that include reflectors, the average and maximum illuminance values are absolute. For other sources, they correspond to an ideal 1,000 lm flux.

Isolux

The photometric results of a lighting installation can be shown on a surface using an "Isolux", that is, lines connecting the points with the same illuminance. Isolux diagrams are used to quickly determine, albeit in an approximate manner, the average value and uniformity of the illuminance.

Photometric classification of luminaires

Using the classification of luminous flux distribution and using the various ratios between the flux emitted by a luminaire in the upper and lower hemispheres, as well as the ratio of their different yields, a luminaire can be classified on the basis of different recommendations and standards: CIE, DIN 5040, UTE, and CIBSE LG3.

CIE

Diagram of flux distribution by a luminaire inside cones with specific angles; the last number of the series provides the total output ratio of the luminaire. Illuminating luminaires are classified on the basis of five numbers (CIE codes)

$$N_1 = F_1/F_4 \quad N_2 = F_2/F_4 \quad N_3 = F_3/F_4 \quad N_4 = F_4/F_5 \quad N_5 = F_5/F_5 = \text{yield}$$

Where:

F_1 is the flux emitted in the solid angle cone $\pi/2$, vertex angle 83°

F_2 is the flux emitted in the solid angle cone π , vertex angle 120°

F_3 is the flux emitted in the solid angle cone $3\pi/2$, vertex angle 151°

F_4 is the flux emitted in the solid angle cone 2π , vertex angle 180°

F_5 is the flux emitted in the solid angle cone 4π , vertex angle 360°

F is the installed flux.

DIN 5040

Die photometrische Klassifizierung erfolgt mit einem Buchstaben und zwei Ziffern. Der Buchstabe zeigt die Lichtverteilung an, angefangen bei A: A: Direktes, konzentriertes Licht, bis zu E: Indirektes Licht. Die erste Ziffer zeigt den Stromflussanteil nach unten an (direktes Licht). Die zweite Ziffer zeigt den Stromflussanteil nach oben an (indirektes Licht).

UTE

Die photometrische Klassifizierung erfolgt mit einer Ziffer, die die direkte Leistung anzeigt, gefolgt von einem Buchstaben, der die Lichtverteilung angibt, angefangen bei A für ein enges Lichtbündel bis zu J für halbdirektes Licht. Sollte die Leuchte ebenfalls indirektes Licht ausstrahlen (nach oben), so wird die indirekte Leistung hinzugefügt gefolgt von dem Buchstaben "T". Eine Leuchte z.B., die 30% ihres Lichtstroms nach unten verbreitet und 35% nach oben mit indirekter Lichtabgabe wird nach UTE folgendermaßen eingestuft: 0,30J + 0,35T.

CIBSE LG3

Mit den Abänderungen zur Lighting Guidance 3 von 2001 wird das Klassifizierungssystem nach Kategorien (Cat) aufgehoben, um sich den Europäischen Normenvorschriften EN 12464-1 anzugleichen. Diese englische Norm stuft die Leuchten je nach der Luminanz auf vier Ebenen in drei Kategorien ein: C0-180, C90-270, C135-315 e C225-45. Zur Kategorie CIBSE LG3 Cat 1 gehören Leuchten mit einer Leuchtdichte unter 200 cd/m² für Beobachtungswinkel γ ab 55°. Zur Kategorie CIBSE LG3 Cat 2 gehören Leuchten mit einer Leuchtdichte unter 200 cd/m² für Beobachtungswinkel γ ab 65°. Zur Kategorie CIBSE LG3 Cat 3 gehören Leuchten mit einer Leuchtdichte unter 200 cd/m² für Beobachtungswinkel γ ab 75°.

Farbige Filter

Durch das Anbringen von farbigen Filtern an eine Leuchte können die photo- und colorimetrischen Charakteristiken verändert werden, z. B. die Farbtemperatur der Leuchte, um sie spezifischen Erfordernissen einer gezielten Objektbeleuchtung oder eines besonderen Ambientes anzupassen. Der Einsatz von Filtern reduziert darüber hinaus die Lichtemission, und zwar in verschiedenem Maß je nach den Charakteristiken des Filters.

Eulumdat-Dateien

Die Eulumdat-Dateien für sämtliche Leuchten von FLOS stehen unter www.flos.com zur Verfügung und können für beleuchtungstechnische Berechnungsprogramme herangezogen werden.

DIN 5040

The photometric classification of luminaires consists of a letter and two numbers. The letter indicates the luminous distribution starting from A: direct concentrated to E: indirect. The first number indicates the percentage of luminous flux emitted in the lower hemisphere (direct). The second number indicates the percentage of luminous flux in the upper hemisphere (indirect).

UTE

The photometric classification of luminaires consists of a number that indicates the direct output ratio followed by a letter that indicates the luminous distribution starting from A for a narrow angle to J for semi-indirect. Should the luminaire also have indirect emission (upper hemisphere), the indirect yield followed by the letter "T" is added. For example, for a luminaire emitting 30% of its flux downwards and 35% upwards, with a semi-indirect emission, the UTE code would be 0.30J + 0.35T.

CIBSE LG3

With the amendment of Lighting Guidance 3 in 2001, the category classification system (Cat) was abolished to conform to European Standard EN 12464-1. This British Standard classified luminaires in three luminance categories: C0-180, C90-270, C135-315 and C225-45. CIBSE LG3 Cat 1 if luminance was lower than 200 cd/m² starting at a 55° observation angle γ . CIBSE LG3 Cat 2 if luminance was lower than 200 cd/m² starting at a 65° observation angle γ . CIBSE LG3 Cat 3 if luminance was lower than 200 cd/m² starting at a 75° observation angle γ .

Colored Filters

The use of colored filters in a luminaire modifies its photo-colorimetric features, for example the color temperature of the light bulb, adapting it for accent lighting or for a special setting. The use of filters also reduces the luminous output which can vary depending on the filter's characteristics.

Eulumdat Files

The Eulumdat files of all the FLOS luminaires are available on our website www.flos.com, so they can be used in technical lighting calculations.

SOFT ARCHITECTURE

Wall Rupture, Softprofile, Kaprofile,
Juncos, Wall Piercing, Soft Spun, Abajourd'hui,
Usb Boob, Usb Out, Apps,
G-O In, Teardrop, Usb,
Round, Square & Vertical Light,
Usb Round & Square Light.



Wall Rupture



Softprofile Smooth

Smooth Small

Smooth Large



Softprofile Deco

Starck Small

Starck Large

Wanders Small

Wanders Large



Kaprofile



Wall Rupture Designed By Thierry Dreyfus

Light Source: LED White - Gold Finish - 17,5W/m - 1140 lm/m - 2700K / LED White - Silver Finish - 17,5W/m - 1225 lm/m - 5000K

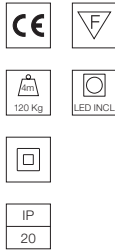
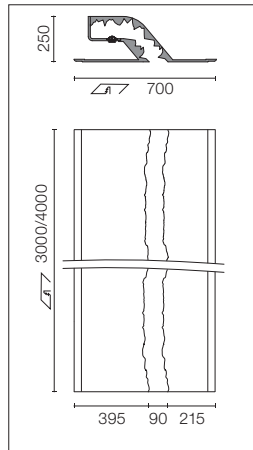

Einbauleuchte für die Wandmontage mit Soft Technologie. LED-Module mit unterschiedlichen Farbtemperaturen je nach Raumausstattung sowie Systeme ohne Dimmer sind eingeschlossen. Inklusive 220/240V-Netzteil.

Soft technology wall-mounted, recessed luminaire. LED modules to emit lights with different colour temperature depending on décor; non-dimmable gear included. 220/240V power supply included.

Für eine persönliche configuration setzen sie sich bitte mit dem verkaufsteam von Flos architectural in verbindung.

For personal configuration ask Flos architectural sales team.

Profile

- 3m SA.2423.5A145
- SA.2423.5A165
- 4m SA.2424.5A145
- SA.2424.5A165

Wall Rupture with End caps Designed By Thierry Dreyfus

Light Source: LED White - Gold Finish - 17,5W/m - 1140 lm/m - 2700K / LED White - Silver Finish - 17,5W/m - 1225 lm/m - 5000K

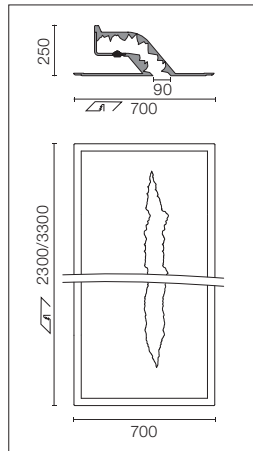

End cap

- 2,3m SA.2453.5A145
- SA.2453.5A165
- 3,3m SA.2454.5A145
- SA.2454.5A165



SOFT ARCHITECTURE | LINEAR

Softprofile Smooth Small Designed By Flos Soft Architecture

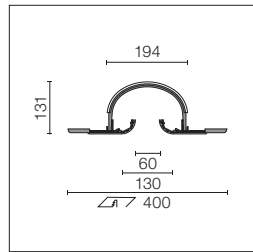

Endkappe / End cap

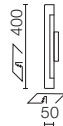

Einbauleuchte für die Wand- oder Deckenmontage mit Soft Technologie. Beidseitige Installation von LED-Modulen möglich. Beleuchtungssysteme nicht eingeschlossen.

Soft technology wall or ceiling-mounted recessed luminaire. It permits the installation of LED modules on both sides. Lighting systems not included.

Siehe LED-Module und LED-Steuergeräte.

See LED modules and LED drivers.

Profile

3m
SA.2293.1
4m
SA.2294.1

End cap
SA.2295.1

Softprofile Smooth Large Designed By Flos Soft Architecture

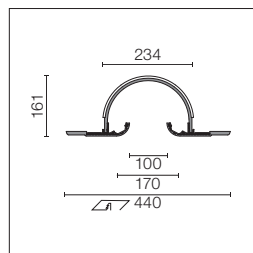

Endkappe / End cap



Einbauleuchte für die Wand- oder Deckenmontage mit Soft Technologie. Beidseitige Installation von LED-Modulen möglich. Beleuchtungssysteme nicht eingeschlossen.

Soft technology wall or ceiling-mounted recessed luminaire. It permits the installation of LED modules on both sides. Lighting systems not included.

Siehe LED-Module und LED-Steuergeräte.

See LED modules and LED drivers.

Profile

3m
SA.2323.1
4m
SA.2324.1

End cap
SA.2325.1

Softprofile Deco Starck Small Designed By Philippe Starck

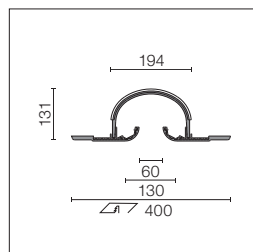

Endkappe / End cap

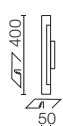

Einbauleuchte für die Wand- oder Deckenmontage mit Soft Technologie. Beidseitige Installation von LED-Modulen möglich. Beleuchtungssysteme nicht eingeschlossen.

Soft technology wall or ceiling-mounted recessed luminaire. It permits the installation of LED modules on both sides. Lighting systems not included.

Siehe LED-Module und LED-Steuergeräte.

See LED modules and LED drivers.

Profile

3m
SA.2313.1
SA.2313.3.120
SA.2313.3.140
SA.2313.3.160
4m
SA.2314.1
SA.2314.3.120
SA.2314.3.140
SA.2314.3.160

End cap
SA.2295.1

SOFT ARCHITECTURE | LINEAR

Softprofile Deco Starck Large Designed By Philippe Starck

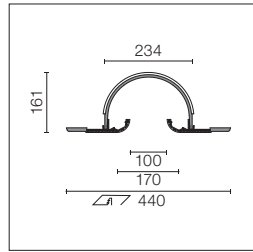

Einbauleuchte für die Wand- oder Deckenmontage mit Soft Technologie. Beidseitige Installation von LED-Modulen möglich. Beleuchtungssysteme nicht eingeschlossen.

Soft technology wall or ceiling-mounted recessed luminaire. It permits the installation of LED modules on both sides. Lighting systems not included.

Siehe LED-Module und LED-Steuergeräte.

See LED modules and LED drivers.

Endkappe / End cap



Profile

- 3m
 - SA.2343.1
 - SA.2343.3.120
 - SA.2343.3.140
 - SA.2343.3.160
- 4m
 - SA.2344.1
 - SA.2344.3.120
 - SA.2344.3.140
 - SA.2344.3.160

End cap
SA.2325.1

Softprofile Deco Wanders Small Designed By Marcel Wanders

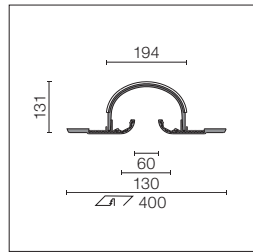

Einbauleuchte für die Wand- oder Deckenmontage mit Soft Technologie. Beidseitige Installation von LED-Modulen möglich. Beleuchtungssysteme nicht eingeschlossen.

Soft technology wall or ceiling-mounted recessed luminaire. It permits the installation of LED modules on both sides. Lighting systems not included.

Siehe LED-Module und LED-Steuergeräte.

See LED modules and LED drivers.

Endkappe / End cap

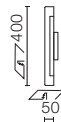

Profile

- 3m
 - SA.2303.1
 - SA.2303.3.120
- 4m
 - SA.2304.1
 - SA.2304.3.120

End cap
SA.2295.1

Softprofile Deco Wanders Large Designed By Marcel Wanders

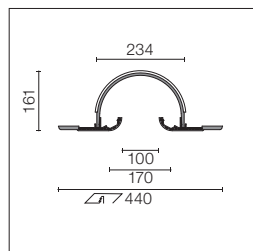

Einbauleuchte für die Wand- oder Deckenmontage mit Soft Technologie. Beidseitige Installation von LED-Modulen möglich. Beleuchtungssysteme nicht eingeschlossen.

Soft technology wall or ceiling-mounted recessed luminaire. It permits the installation of LED modules on both sides. Lighting systems not included.

Siehe LED-Module und LED-Steuergeräte.

See LED modules and LED drivers.

Endkappe / End cap

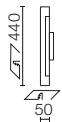

Profile

- 3m
 - SA.2333.1
 - SA.2333.3.120
- 4m
 - SA.2334.1
 - SA.2334.3.120

End cap
SA.2325.1

SOFT ARCHITECTURE | LINEAR

Kapprofile Designed By Flos Soft Architecture

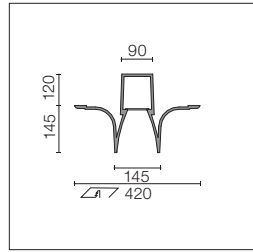

Modulares Profil mit Soft Technologie für die Deckenmontage. Leuchtstoff-Beleuchtungssysteme nicht eingeschlossen. Siehe Lineares T5-Modul Doppelt. Die Profile können auf die gewünschte Länge zugeschnitten werden. Wenden Sie sich für die Installation von LED-Modulen an das Front Office.

Soft technology ceiling-mounted modular profile. Fluorescence lighting systems not included. See Linear Module T5 Double. Profiles can be cut to the desired length. Consult the front office for LED module installation.

Endkappe / End cap

*Ecke / Corner

2m
SA.2282.1

End cap 1m
SA.2285.1

Corner
SA.2286.1

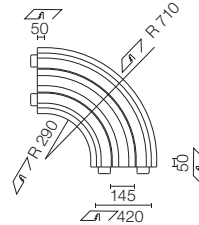
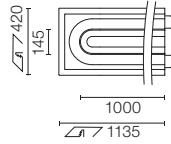

* In Ecke, Lampenmodule im Lieferumfang enthalten.
* In Corner, lighting modules included.

SOFT ARCHITECTURE | LINEAR

USP T5 DIRECT LIGHT - T5 MODULE

For Kappprofile

Lineares T5-Modul Doppelt Linear Module T5 Double

	T5 FH 	Referenz Reference	Wattleistung (W) Wattage (W)	Länge (L) Lenght (L)	*Numer (Nr) Number (N°)
Lineares T5-Modul für optimale Beleuchtung ohne dunkle Bereiche, die durch die Überlagerung vermieden werden. Die Module sind in einer dimmbaren Version verfügbar und für verschiedene T5-Wattleistungen (hohe Effizienz). Lampe nicht inbegriffen.		Non Dimmable 08.8306.00	2x21	1025	9
		08.8307.00	2x28	1325	9
		08.8308.00	2x35	1625	9
Linear T5 module for optimal illumination without dark zones, which are avoided by the overlapping. The modules are available in a dimmable version, and for different T5 wattages (high efficiency). Lamp not included.		Dimmable 1-10V 08.8320.00	2x21	1025	9
		08.8321.00	2x28	1325	9
		08.8322.00	2x35	1625	9
		Dimmable Dali 08.8314.00	2x21	1025	9
		08.8315.00	2x28	1325	9
		08.8316.00	2x35	1625	9

* Nr: Maximale Modulanzahl, die in einer Reihe verbunden werden kann / N°: Maximum number of modules connected in one line.

Lineares T5-Modul Doppelpertes Schema Linear Module T5 Double Scheme



Lineares T5-Modul Doppelte Verbindung Linear Module T5 Double Connection

Maximale Überlagerung / Maximum Overlapping

Wattleistung Wattage (W)	A	B	*Numer Number (N°)
2x21	875	1900	9
2x28	1175	2500	9
2x35	1475	3100	9

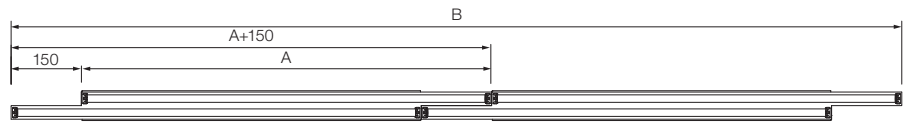

Minimale Überlagerung / Minimum Overlapping

Wattleistung Wattage (W)	A	C	*Numer Number (N°)
2x21	875	1975	9
2x28	1175	2575	9
2x35	1475	3175	9

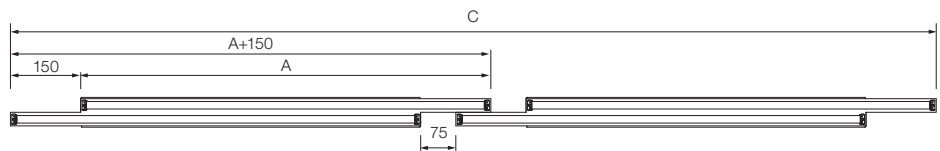

Zubehör / Accessories

Zuleitung mit Steckerbuchse.
Dreipolig, Länge: 250mm. Nur für
Versionen ohne Dimmer. Muss
separat bestellt werden.

Feed cable with female plug. Three
poles, lenght: 250mm. Only for
not dimmable versions. Must be
ordered separately.

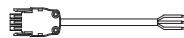

08.8330.00

Zuleitung mit Steckerbuchse.
Dreipolig, Länge: 250mm.
Zuleitung für Signal 1-10 V/DALI
im Lieferumfang enthalten. Muss
separat bestellt werden.

Feed cable with female plug. Three
poles, lenght: 250mm. Feed cable
for signal 1-10V / DALI included.
Must be ordered separately.



08.8356.00

SOFT ARCHITECTURE | LINEAR

LED DRIVERS

For: Softprofile Smooth - Softprofile Deco

Lineares LED-Modul Linear Module LED

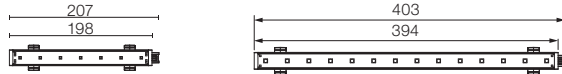

LED-Modul für optimale indirekte Beleuchtung. Tyco-Stecker, Stiftstecker / Buchsenleisten, für elektrische einfache Verbindung in beiden Seiten. Kann direkt an das Profil geklemmt werden.

LED module for optimal indirect illumination. Tyco connections male / female for easy electrical connection in both sides. Can be clipped directly to the Profile.

White

08.8512.00C
3,5W
228 lm
3000K
CRI 85

08.8513.00C
7W
456 lm
3000K
CRI 85

RGB

08.8294.00A
1,7W
77 lm
CRI>90

08.8296.00A
3,5W
154 lm
CRI>90

Non Dimmable

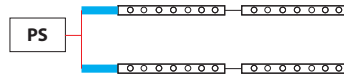

Verkabelung Wiring

500-mm-Zuführungskabel für weiße LED-Module mit Schnellverbindung. Ein Kabel pro LED-Reihe erforderlich (zwei pro Profil). Maximum pro Zuführungskabel: 3 Meter LED-Reihen. Elektronische Stromversorgung nicht inbegriffen.

500mm feed cable for white LED modules with fast connection. Necessary one for each LED line (two for each Profile). Maximum for each feed cable: 3 LED line meters. Electronic power supply not included.

White

06.1016.00

Dimmable 1-10V

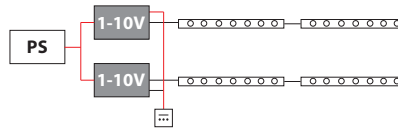

Dimmbare Interfaces Dimmable Interface

1-10V-Interface mit zwei 500-mm-Zuführungskabeln für weiße LED-Module mit 06.1022.00 Schnellverbindung. Maximum für jedes Interface: 6 LED-Meter. Elektronische Stromversorgung nicht inbegriffen.

1-10V interface with two 500mm feed cable for white LED modules with fast connection. Maximum for each interface: 6 LED meters. Electronic power supply not included.

White

06.1022.00

1-10V

Dimmbare Interfaces Dimmable Interfaces

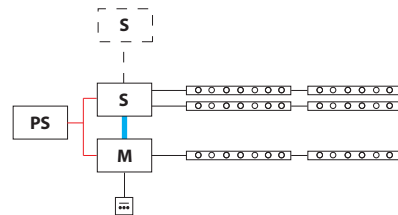

Dali Master-Interface mit einem 5 poligen Verteiler und zwei 500-mm- Zuführungskabeln für einfache Verbindung. Elektronische Stromversorgung nicht inbegriffen.

Dali Master interface with one 5 pole distributor and two 500mm feed cable for easy connection. Electronic power supply not included.

White

06.1023.00

M

RGB

06.1025.00

M

DMX Master-Interface mit 5 poligem Verteiler und zwei 500-mm-Zuführungskabeln für einfache Verbindung. Elektronische Stromversorgung nicht inbegriffen.

DMX Master interface with 5 pole distributor and two 500mm feed cable for easy connection. Electronic power supply not included.

06.1026.00

M

Radiofrequenz (RF) RGB Master-Interface mit einem 5 poligen Verteiler und zwei 500-mm-Zuführungskabeln für einfache Verbindung. Wand-Transmitter für integrierte Farbänderung. Elektronische Stromversorgung nicht inbegriffen.

Radio Frequency (RF) RGB Master interface with 5 pole distributor and two 500mm feed cable for easy connection. Wall transmitter to make color changing integrated. Electronic power supply not included.

06.1027.00

M

SOFT ARCHITECTURE | LINEAR





LED DRIVERS

For: Softprofile Smooth - Softprofile Deco

Dimmbare Interfaces Dimmable Interfaces

Slave-Interface, um das Signal mit zwei 5 poligen Verteilern und vier 500-mm-Zuführungskabeln für einfache Verbindung zu erweitern. Elektronische Stromversorgung nicht inbegriffen.

Slave interface to expand the signal with two 5 pole distributors and four 500mm feed cable for easy connection. Electronic power supply not included.

	White	RGB
	06.1024.00 	06.1028.00 
	08.8297.00 	08.8298.00 

Stromversorgung / Power Supply

Montage in Zwischendecke Installation in False Ceiling

 PS

Ferninstallation im Verteilerkasten Remote Installation Electrical Panel

 PS

Elektronische 25W / Electronic 25W

Stromversorgung / Power supply
LED. 25W – 24V. 100-240V, 50-60Hz.

60.8703

Elektronische 240W / Electronic 240W

Stromversorgung / Power supply
LED. 240W – 24V. 100-240V, 50-60Hz.

60.8268

Elektronische 60W / Electronic 60W

Stromversorgung / Power supply
LED. 60W – 24V. 100-240V, 50-60Hz.









60.9089

Elektronische 120W / Electronic 120W

Stromversorgung / Power supply
LED. 120W – 24V. 100-240V, 50-60Hz.

60.9407

Installationstabellen / Installation Guidelines

	White					RGB					
	20W	60W	100W	150W	240W	20W	60W	100W	150W	240W	
Max länge LED* Max lenght LED*	1m	3,5m	5,5m	8m	13m	2m	8m	12m	20m	34m	
Kabel-abschnitt (vom installateur zur verfügung gestellt) Cable section (installer provides)	0,5mm ²	0,5mm ²	0,75mm ²	0,75mm ²	1mm ²	0,5mm ²	0,5mm ²	0,75mm ²	0,75mm ²	1mm ²	
Max abstand Max distance	 	5m	10m	15m	30m	50m	5m	10m	15m	30m	50m
Max abstand Max distance	 	20m					20m				
Max abstand Max distance	 	20m					20m				
Max länge der LED module bei anschluss an Max lenght LED connected to		2m					7m				
Max länge der LED module bei anschluss an Max lenght LED connected to		4m					14m				

* Achtung: Bei Softprofile, 2x LED-Länge = Profillänge / Beware: For Softprofile, 2x LED lenght = profile lenght



Juncos

Juncos 1L



Juncos 3L



Juncos 6L



Juncos 9L



Wall Piercing

Wall Piercing 1X



Wall Piercing 2X



Wall Piercing 4X



Wall Piercing 2X Line



Soft Spun

Soft Spun Small
Halogen/ Fluorescent/
LED



Soft Spun Large
Halogen/ Fluorescent/
LED



Abajourd'hui

Abajourd'hui Small



Abajourd'hui Large



Juncos Designed By Flos Soft Architecture

Juncos 1L

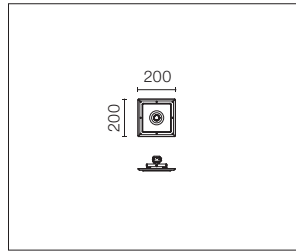

LED-Halbeinbauleuchte für Innenräume. In Verbindung mit der Soft Architecture Technologie integriert sie sich perfekt in den Architekturraum. Ohne Netzgerät. Siehe Treiber auf der nächsten Seite.

Semi-recessed LED luminaire for indoor applications. Seamless integration in the architectural environment by Soft Architecture technology. Power supply not included. See driver in next page.

Produkt mit Vorverkabelung zum Anschluss an Konstantstrom.

Pre-wired product to be connected to constant current.

Juncos 3L

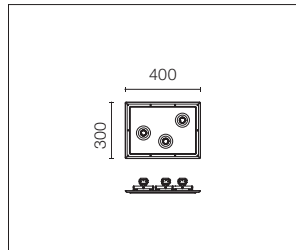

Produkt mit Reihenschaltung-Vorverkabelung zum Anschluss an Konstantstrom.

Pre-wired product for serial connection to constant current.

Juncos 6L

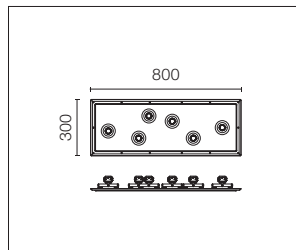

Produkt mit Reihenschaltung-Vorverkabelung zum Anschluss an Konstantstrom.

Pre-wired product for serial connection to constant current.

Juncos 9L

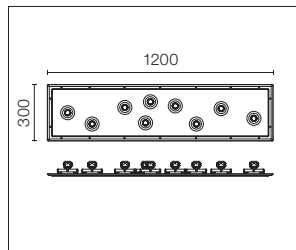

Produkt mit Reihenschaltung-Vorverkabelung zum Anschluss an Konstantstrom.

Pre-wired product for serial connection to constant current.

Soft Platte / Soft Plate

- Juncos 1L
SA.5200.5.120
- Juncos 3L
SA.5201.5.120
- Juncos 6L
SA.5202.5.120
- Juncos 9L
SA.5203.5.120

Junco 250 mm

Light Source: Power LED DC 700 mA - 2,1W - 216 lm - 3000K/CRI 80 / 2,1W - 182 lm - 2700K/CRI 90

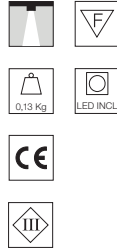
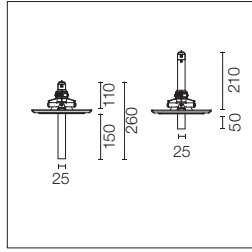

Vielseitige Leuchte. Individuell ausrichtbar und regulierbare Einbautiefe. Erhältlich in Schwarz, Weiß und Chrom.

Luminaire that offers many possibilities. Can be individually focused and their recessed height is adjustable. Available in a black, white and chrome finish.

Junco 400 mm

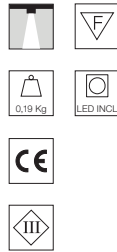
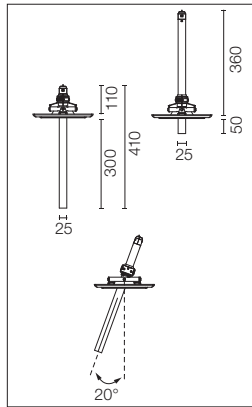

Junco 250 mm

- 08.8595.40A
- 08.8595.06A
- 08.8595.AAA

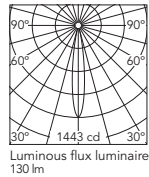

Beam Angle: 15°

h(m)	E(lx)	D(m)
1	1443	0.27
2	361	0.53
3	160	0.80
4	90	1.07
5	58	1.34

Luminous flux luminaire 130 lm

3000K

- 08.8590.40A
- 08.8590.06A
- 08.8590.AAA

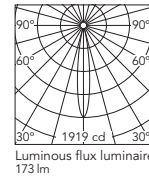

Beam Angle: 15°

h(m)	E(lx)	D(m)
1	1919	0.27
2	480	0.53
3	213	0.80
4	120	1.07
5	77	1.34

Luminous flux luminaire 173 lm

Junco 400 mm

- 08.8596.40A
- 08.8596.06A
- 08.8596.AAA

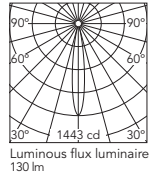

Beam Angle: 15°

h(m)	E(lx)	D(m)
1	1443	0.27
2	361	0.53
3	160	0.80
4	90	1.07
5	58	1.34

Luminous flux luminaire 130 lm

3000K

- 08.8591.40A
- 08.8591.06A
- 08.8591.AAA

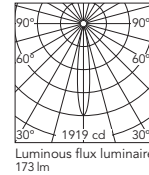

Beam Angle: 15°

h(m)	E(lx)	D(m)
1	1919	0.27
2	480	0.53
3	213	0.80
4	120	1.07
5	77	1.34

Luminous flux luminaire 173 lm

Treiber / Drivers

Nicht regulierbares Konstantstrom-Netzgerät mit 17W, 700mA - 100/240V - 50/60Hz.

Non dimmable continuous current power supply of 17W, 700mA - 100/240V - 50/60Hz.

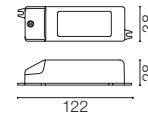

60.8655

Nicht regulierbares Konstantstrom-Netzgerät mit 32W, 700mA - 220/240V - 50/60Hz.

Non dimmable continuous current power supply of 32W, 700mA - 220/240V - 50/60Hz.

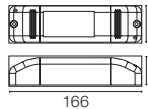

60.8534

Konstantstrom-Netzgerät mit 25W, 120-240V / 50-60Hz mit wählbarer Stromversorgung über Schalter 700mA, regulierbar per 1-10V oder Druckdimmer.

Continuous current power supply of 25W, 120-240V - 50/60Hz with power current selected through adjustable 700mA 1-10V switch or push dimming.

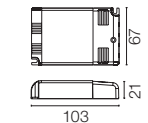

60.8533

Maximale entfernung des LED-geräts / Max. distance from LED driver			
Konstantstromgerät / constant current driver (700ma)			
Entfernung / Distance	10 m	20 m	50 m
Kabelquerschnitt / Cable section	0,5mm ²	1mm ²	2,5mm ²

Wall Piercing 1X Designed By Ron Gilad

Light Source: LED White 1x6,4W - 416 lm - 2700K/CRI>90 / LED RGB 1x7,4W

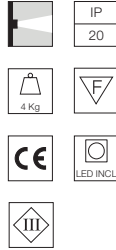
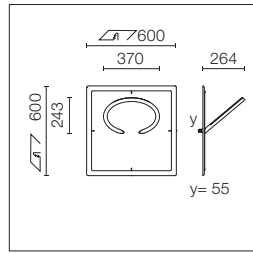

Halb-Einbauleuchte für die Wand- oder Deckenmontage. Erhältlich in den Versionen LED weiß oder RGB. Betriebs- und Steuergeräte nicht eingeschlossen.

LED-Module inbegriffen. Für Stromversorgung und Dimmer-Interface siehe LED-Treiber.

Soft technology semi-recessed luminaire for ceiling or wall mounting. Available in white LED or RGB versions. Control gear not included.

LED modules included. For power supply and dimming interface see LED drivers.

LED White
SA.5020.5A120
SA.5020.5A180

LED RGB
SA.5020.6A120
SA.5020.6A180

Wall Piercing 2X Designed By Ron Gilad

Light Source: LED White 2x6,4W - 2x416 lm - 2700K/CRI>90 / LED RGB 2x7,4W

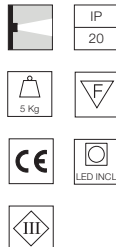
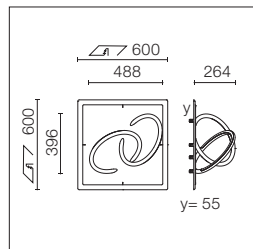

Halb-Einbauleuchte für die Wand- oder Deckenmontage. Erhältlich in den Versionen LED weiß oder RGB. Betriebs- und Steuergeräte nicht eingeschlossen.

LED-Module inbegriffen. Für Stromversorgung und Dimmer-Interface siehe LED-Treiber.

Soft technology semi-recessed luminaire for ceiling or wall mounting. Available in white LED or RGB versions. Control gear not included.

LED modules included. For power supply and dimming interface see LED drivers.

LED White
SA.5021.5A120
SA.5021.5A180

LED RGB
SA.5021.6A120
SA.5021.6A180



Wall Piercing 4X Designed By Ron Gilad

Light Source: LED White 4x6,4W - 4x416 lm - 2700K/CRI>90 / LED RGB 4x7,4W

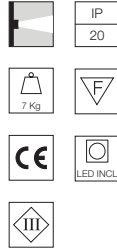
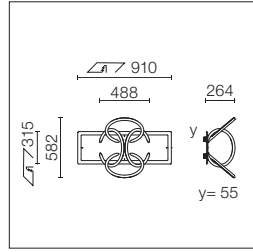

Halb-Einbauleuchte für die Wand- oder Deckenmontage. Erhältlich in den Versionen LED weiß oder RGB. Betriebs- und Steuergeräte nicht eingeschlossen.

LED-Module inbegriffen. Für Stromversorgung und Dimmer-Interface siehe LED-Treiber.

Soft technology semi-recessed luminaire for ceiling or wall mounting. Available in white LED or RGB versions. Control gear not included.

LED modules included. For power supply and dimming interface see LED drivers.

LED White
 SA.5022.5A120
 SA.5022.5A180

LED RGB
 SA.5022.6A120
 SA.5022.6A180

Wall Piercing 2X Line Designed By Ron Gilad

Light Source: LED White 2x6,4W - 2x416 lm - 2700K/CRI>90 / LED RGB 2x7,4W

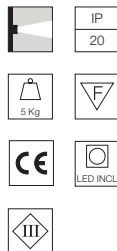
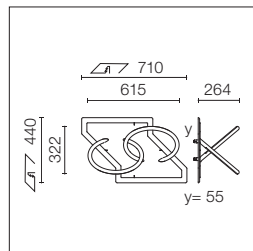

Halb-Einbauleuchte für die Wand- oder Deckenmontage. Erhältlich in den Versionen LED weiß oder RGB. Betriebs- und Steuergeräte nicht eingeschlossen.

LED-Module inbegriffen. Für Stromversorgung und Dimmer-Interface siehe LED-Treiber.

Soft technology semi-recessed luminaire for ceiling or wall mounting. Available in white LED or RGB versions. Control gear not included.

LED modules included. For power supply and dimming interface see LED drivers.

LED White
 SA.5023.5A120
 SA.5023.5A180

LED RGB
 SA.5023.6A120
 SA.5023.6A180



SOFT ARCHITECTURE | 3D

LED DRIVERS

For Wall Piercing

Non Dimmable

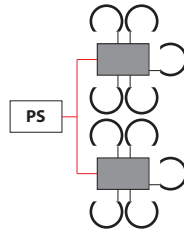

Verkabelung Wiring

5 poliger Verteiler für einfache Verbindung mit Zuführungskabel. Es können bis zu 5 Wandhalterungen angeschlossen werden. Elektronische Stromversorgung nicht inbegriffen.

5 male pole distributor for easy connection with feed cable. It's able to connect up to 5 Wall Piercings. Electronic power supply not included.

White

06.1003.00

Dimmable 1-10V

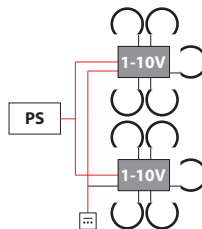

Dimmbare Interfaces Dimmable Interface

1-10V-Interface. 5 poliger Verteiler für einfache Verbindung integriert. Es können bis zu 5 Wandhalterungen angeschlossen werden. Elektronische Stromversorgung nicht inbegriffen.

1-10V interface. 5 pole distributor for easy connection integrated. It's able to connect up to 5 Wall Piercings. Electronic power supply not included.

White

06.1011.00

1-10V

Dimmbare Interfaces Dimmable Interfaces

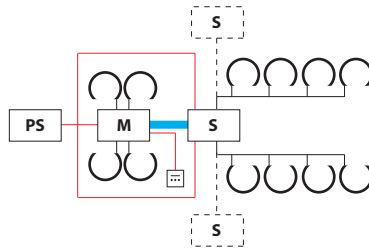

DALI Master-Interface mit 5 poligem Verteiler für einfache Verbindung integriert. Es können bis zu 5 Wandhalterungen gesteuert werden. Falls die Installation mehr Wandhalterungen umfasst, muss das Signal mit Slave-Interfaces erweitert werden. Elektronische Stromversorgung nicht inbegriffen.

DALI Master interface with 5 pole distributor for easy connection integrated. It's able to control up to 5 Wall Piercing. If more Wall Piercings are in the same installation it's necessary to expand the signal with Slave interfaces. Electronic power supply not included.

White

06.1019.00

M

RGB

06.1012.00

M

DMX Master-Interface mit 5 poligem Verteiler für einfache Verbindung integriert 06.1005.00. Es können bis zu 5 Wandhalterungen gesteuert werden. Falls die Installation mehr Wandhalterungen umfasst, muss das Signal mit Slave-Interfaces erweitert werden. Elektronische Stromversorgung nicht inbegriffen.

DMX Master interface with 5 pole distributor for easy connection integrated. It's able to control up to 5 wall piercing. If more Wall Piercings are in the same installation it's necessary to expand the signal with Slave interfaces. Electronic power supply not included.

06.1005.00

M

— Vom Installateur zur Verfügung gestellt / Installer provides

SOFT ARCHITECTURE | 3D

LED DRIVERS



For Wall Piercing

Dimmbare Interfaces Dimmable Interfaces	White	RGB
<p>Radiofrequenz (RF) RGB Master-Interface mit einem 5 poligen Verteiler für einfache Verbindung integriert. Wand-Transmitter für integrierte Farbänderung. Es können bis zu 5 Wandhalterungen gesteuert werden. Falls die Installation mehr Wandhalterungen umfasst, muss das Signal mit Slave-Interfaces erweitert werden. Elektronische Stromversorgung nicht inbegriffen.</p> <p>Radio Frequency (RF) RGB Master interface with 5 pole distributor for easy connection integrated. Wall transmitter to make color changing integrated. It's able to control up to 5 Wall Piercings. If more Wall Piercings are in the same installation it's necessary to expand the signal with Slave interfaces. Electronic power supply not included.</p>		<p>06.1013.00</p> <p>M</p>
<p>Slave-Interface, um das DALI/DMX/RF-Signal mit zwei 5 poligen Verteilern für einfache Verbindung zu erweitern. Kann das Master-Signal auf 10 Wandhalterungen erweitern. Falls die Installation mehr Wandhalterungen umfasst, muss das Signal mit zusätzlichen Slave-Interfaces erweitert werden. Elektronische Stromversorgung nicht inbegriffen.</p> <p>Slave interface to expand the DALI/DMX/RF signal with two 5 pole distributors for easy connection. It's able to expand the Master signal in 10 Wall Piercings. If more Wall Piercings are in the same installation it's necessary to expand the signal with more Slave interfaces. Electronic power supply not included.</p>	<p>06.1020.00</p> <p>S</p>	<p>06.1014.00</p> <p>S</p>
<p>2-Meter-Verlängerungskabel für LED-Module mit einfache Verbindung. Können verbunden werden, um die Länge zu vergrößern. Max. 20 Meter.</p> <p>2 meters prolongation cable for LED modules with fast connection. Can be connected with each other to greater length. 20 meters max.</p>	<p>08.8297.00</p> <p>—</p>	<p>08.8298.00</p> <p>—</p>

Stromversorgung / Power Supply

Montage in Zwischendecke Installation in False Ceiling	PS	Ferninstallation im Verteilerkasten Remote Installation Electrical Panel	PS
<p>Elektronische 25W / Electronic 25W Stromversorgung / Power supply LED. 25W – 24V. 100-240V, 50-60Hz.</p>	60.8703	<p>Elektronische 240W / Electronic 240W Stromversorgung / Power supply LED. 240W – 24V. 100-240V, 50-60Hz.</p>	60.8268
<p>Elektronische 60W / Electronic 60W Stromversorgung / Power supply LED. 60W – 24V. 100-240V, 50-60Hz.</p>	60.9089		
<p>Elektronische 120W / Electronic 120W Stromversorgung / Power supply LED. 120W – 24V. 100-240V, 50-60Hz.</p>	60.9407		

Installationstabellen Installation Guidelines

		White/RGB				
		20W	60W	100W	150W	240W
Wall Piercing		2	8	13	20	32
Kabel-abschnitt (vom installateur zur verfügung gestellt) Cable section (installer provides)		0,5mm ²	0,5mm ²	0,75mm ²	0,75mm ²	1mm ²
Max abstand Max distance		5m	10m	15m	30m	50m
Max abstand Max distance		20m				
Max abstand Max distance		20m				

Soft Spun Halogen Small Designed By Sebastian Wrong

Light Source: LED QT-DE-12 1xR7s

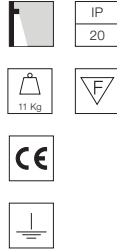
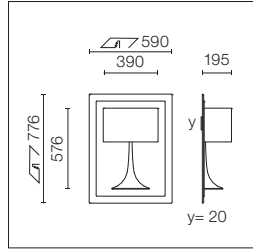

Einbauleuchte für Netzspannung für LED-Retrofit-Lampe.

Recessed luminaire with main voltage source for LED Retrofit lamp.

Siehe Katalog Flos Decorative Collection.

See Flos Decorative Collection catalogue.

SA.5005.1

Soft Spun Halogen Large Designed By Sebastian Wrong

Light Source: LED QT-DE-12 1xR7s (diffuser) / LED White 1,4W - 80 lm - 2700K/CRI>90 (base)

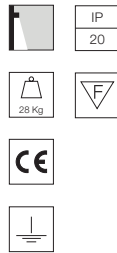
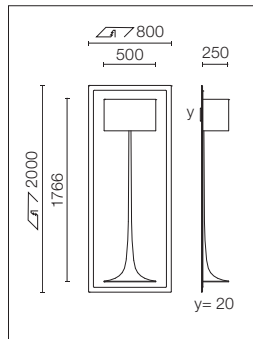

Einbauleuchte für Netzspannung für LED-Retrofit-Lampe. Elektronischer LED-Treiber 220 - 240 V / 50 - 60 Hz integriert.

Recessed luminaire with main voltage source for LED Retrofit lamp. Electronic LED driver 220-240V / 50-60Hz integrated.

Siehe Katalog Flos Decorative Collection.

See Flos Decorative Collection catalogue.

SA.5009.1

Soft Spun Fluorescent Small Designed By Sebastian Wrong

Light Source: TC-L 2x2G11 - 18W

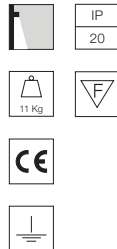
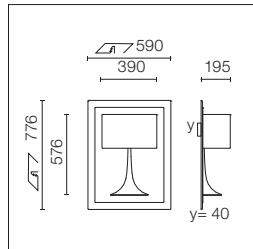

Einbauleuchte für Leuchtstofflampe. Vorschaltgeräte 220/240V ohne Dimmer eingeschlossen.

Recessed luminaire for fluorescent lamp. Non-dimmable 220/240V ballasts included.

Siehe Katalog Flos Decorative Collection.

See Flos Decorative Collection catalogue.

SA.5004.1

Soft Spun Fluorescent Large Designed By Sebastian Wrong

Light Source: TC-L 2x2G11 - 24W (diffuser) / LED White 1,4W - 80 lm - 2700K/CRI>90 (base)

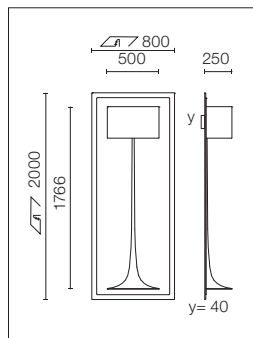

Einbauleuchte für Leuchtstofflampe. Vorschaltgeräte 220/240V ohne Dimmer eingeschlossen.

Recessed luminaire for fluorescent lamp. Non-dimmable 220/240V ballasts included.

Siehe Katalog Flos Decorative Collection.

See Flos Decorative Collection catalogue.

SA.5008.1

Soft Spun LED Small Designed By Sebastian Wrong

Light Source: LED White 35W - 1800 lm - 3000K/CRI 90

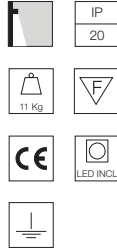
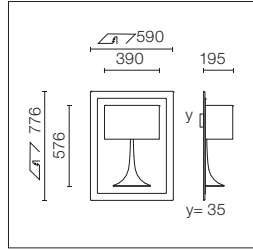

Einbauleuchte für LED-Lampe. Netzteil 220/240V ohne Dimmer eingeschlossen.

Recessed luminaire for LED lamp. Non-dimmable 220/240V power supply included.

Siehe Katalog Flos Decorative Collection.

See Flos Decorative Collection catalogue.

SA.5006.1F

Soft Spun LED Large Designed By Sebastian Wrong

Light Source: LED White 35W - 1800 lm - 3000K/CRI 90 (diffuser) / LED White 1,4W - 80 lm - 2700K/CRI>90 (base)

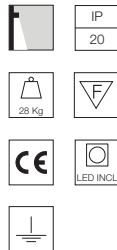
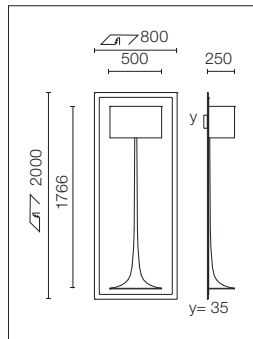

Einbauleuchte für LED-Lampe. Netzteil 220/240V ohne Dimmer eingeschlossen.

Recessed luminaire for LED lamp. Non-dimmable 220/240V power supply included.

Siehe Katalog Flos Decorative Collection.

See Flos Decorative Collection catalogue.

SA.5007.1F

Abajourd'hui Small Designed By Flos Soft Architecture

Light Source: QT-32 E27 - max 75W

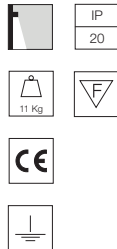
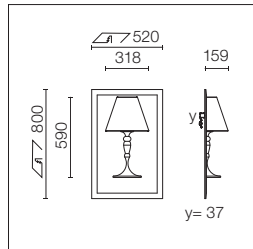

Einbauleuchte mit direktem Netzanschluss. Ausgeschlossene Lichtquelle. Muss separat bestellt werden.

Recessed luminaire with direct connection to mains. Excluded light source. To be ordered separately.

Siehe Katalog Flos Decorative Collection.

See Flos Decorative Collection catalogue.

SA.5001.1

Abajourd'hui Large Designed By Flos Soft Architecture

Light Source: QT-32 E27 - max 150W

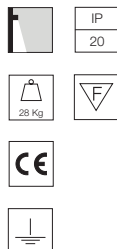
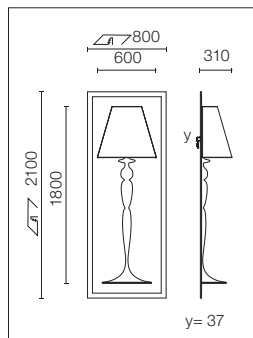

Einbauleuchte mit direktem Netzanschluss.

Recessed luminaire with direct connection to mains.

Siehe Katalog Flos Decorative Collection.

See Flos Decorative Collection catalogue.

SA.5000.1



Uso Boob

USO Boob 600 1L



USO Boob 600 for Modular Ceiling



USO Boob 600 2L

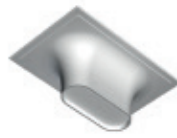

USO Boob 100 1L



USL Out

USL 6031



USL 6031 Recessed



USL 6060 for Modular Ceiling



USO Boob 600 1L Designed By Flos Soft Architecture

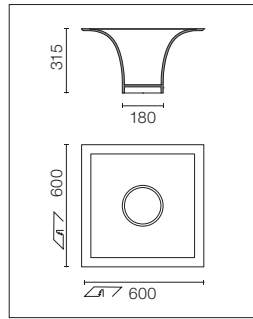

Architektonische Anwendung mit Soft Technologie. Ermöglicht die perfekte Integration der Flos architectural Produkte.
Zur persönlichen Konfiguration können sie Lichtquellen in die Struktur einfügen. Fragen Sie das Verkaufsteam von Flos architectural.

Soft technology architectural application that permits perfect integration of the Flos architectural products.
For personal configuration, you can add light points in the structure. Ask Flos architectural sales team.

Referenzen enthalten keine Produkte von Flos architectural.

References do not include Flos architectural products.

SA.1014.3.001
SA.1014.3.102
SA.1014.3.003
SA.1014.3.004
SA.1014.3.009

SA.1014.3.014
SA.1014.3.116

Empfohlene Produkte von Flos architectural / Flos architectural Recommended Products

Light Sniper	Easy Kap Ø105	Wan Downlight	Wan Spot	Compass Ø162	Kap Ø145*	Kap Ø105*
SA.1014.3.001	SA.1014.3.102	SA.1014.3.003	SA.1014.3.004	SA.1014.3.009	SA.1014.3.014	SA.1014.3.116

* No Trim Rahmen eingeschlossen / Frame No Trim included
No Trim Rahmen nicht inbegriffen. Muss separat bestellt werden /
No Trim Frame excluded. To be ordered separately

USO Boob 600 For Modular Ceiling Designed By Flos Soft Architecture

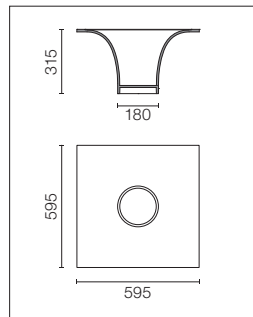

Architektonische Anwendung mit Soft Technologie. Ermöglicht die perfekte Integration der Flos architectural Produkte.
Zur persönlichen Konfiguration können sie Lichtquellen in die Struktur einfügen. Fragen Sie das Verkaufsteam von Flos architectural.

Soft technology architectural application that permits perfect integration of the Flos architectural products.
For personal configuration, you can add light points in the structure. Ask Flos architectural sales team.

Referenzen enthalten keine Produkte von Flos architectural.

References do not include Flos architectural products.

SA.1019.3.001
SA.1019.3.102
SA.1019.3.003
SA.1019.3.004
SA.1019.3.009

SA.1019.3.014
SA.1019.3.116

Empfohlene Produkte von Flos architectural / Flos architectural Recommended Products

Light Sniper	Easy Kap Ø105	Wan Downlight	Wan Spot	Compass Ø162	Kap Ø145*	Kap Ø105*
SA.1019.3.001	SA.1019.3.102	SA.1019.3.003	SA.1019.3.004	SA.1019.3.009	SA.1019.3.014	SA.1019.3.116

* No Trim Rahmen eingeschlossen / Frame No Trim included
No Trim Rahmen nicht inbegriffen. Muss separat bestellt werden /
No Trim Frame excluded. To be ordered separately

SOFT ARCHITECTURE | OUT

USO Boob 600 2L Designed By Flos Soft Architecture

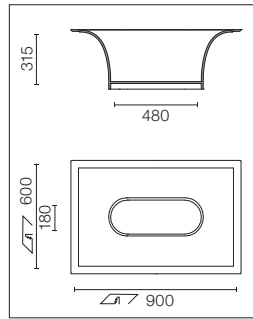

Architektonische Anwendung mit Soft Technologie. Ermöglicht die perfekte Integration der Flos architectural Produkte.
Zur persönlichen Konfiguration können Sie Lichtquellen in die Struktur einfügen. Fragen Sie das Verkaufsteam von Flos architectural.

Soft technology architectural application that permits perfect integration of the Flos architectural products.
For personal configuration, you can add light points in the structure. Ask Flos architectural sales team.

Referenzen enthalten keine Produkte von Flos architectural.

References do not include Flos architectural products.

SA.1015.3.001
SA.1015.3.102
SA.1015.3.003
SA.1015.3.004
SA.1015.3.009

SA.1015.3.014
SA.1015.3.116

Empfohlene Produkte von Flos architectural / Flos architectural Recommended Products

Light Sniper	Easy Kap Ø105	Wan Downlight	Wan Spot	Compass Ø162	Kap Ø145*	Kap Ø105*
SA.1015.3.001	SA.1015.3.102	SA.1015.3.003	SA.1015.3.004	SA.1015.3.009	SA.1015.3.014	SA.1015.3.116

* No Trim Rahmen eingeschlossen / Frame No Trim included
No Trim Rahmen nicht inbegriffen. Muss separat bestellt werden /
No Trim Frame excluded. To be ordered separately

USO Boob 100 1L Designed By Flos Soft Architecture

Light Source: LED QR-CBC-51 1xGU5.3

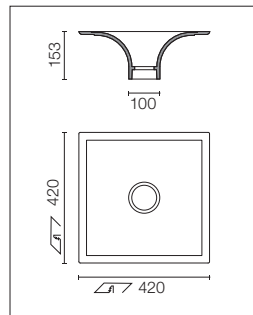

Einbauleuchte für 12 V LED-Retrofit-Lampe. Transformator mit Fernbedienung nicht eingeschlossen: elektronischer Transformator 12V. 220/240V, 50/60Hz mit trailing edge Dimmer.

Recessed luminaire for 12V LED Retrofit lamp. Remote transformer not included: electronic transformer 12V. 220/240V, 50/60Hz. Adjustable by means of "leading and trailing edge".

SA.1012.3.019

Elektrisch / Electrical
50/70W
60.9398
105W
60.9424

SOFT ARCHITECTURE | OUT

USL 6031 Designed By Flos Soft Architecture

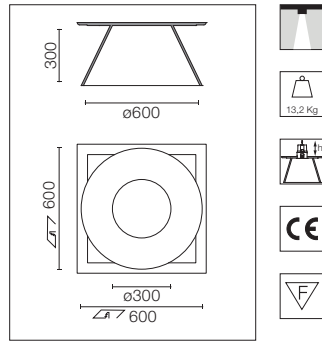

Architektonische Anwendung mit Soft Technologie. Ermöglicht die perfekte Integration der Flos architectural Produkte. Zur persönlichen Konfiguration können Sie Lichtquellen in die Struktur einfügen. Fragen Sie das Verkaufsteam von Flos architectural.

Soft technology architectural application that permits perfect integration of the Flos architectural products. For personal configuration, you can add light points in the structure. Ask Flos architectural sales team.







Referenzen enthalten keine Produkte von Flos architectural.

References do not include Flos architectural products.

SA.4008.3.001
SA.4008.3.102
SA.4008.3.003

SA.4008.3.004
SA.4008.3.009
SA.4008.3.017

Empfohlene Produkte von Flos architectural / Flos architectural Recommended Products

Light Sniper	Easy Kap Ø105	Wan Downlight	Wan Spot	Compass Ø162	Kap Ø145 165mm Hole
					
SA.4008.3.001 h=165	SA.4008.3.102 h=187	SA.4008.3.003 h=111	SA.4008.3.004 h=50	SA.4008.3.009 h=220	SA.4008.3.017 h=230

USL 6031 Recessed Designed By Flos Soft Architecture

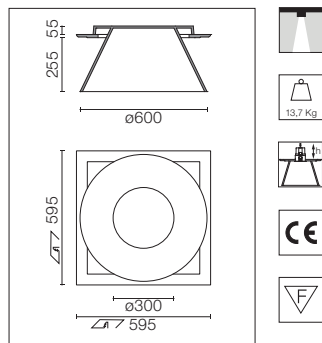

Architektonische Anwendung mit Soft Technologie. Ermöglicht die perfekte Integration der Flos architectural Produkte. Zur persönlichen Konfiguration können Sie Lichtquellen in die Struktur einfügen. Fragen Sie das Verkaufsteam von Flos architectural.

Soft technology architectural application that permits perfect integration of the Flos architectural products. For personal configuration, you can add light points in the structure. Ask Flos architectural sales team.







Referenzen enthalten keine Produkte von Flos architectural.

References do not include Flos architectural products.

SA.4010.3.001
SA.4010.3.102
SA.4010.3.003

SA.4010.3.004
SA.4010.3.009
SA.4010.3.017

Empfohlene Produkte von Flos architectural / Flos architectural Recommended Products

Light Sniper	Easy Kap Ø105	Wan Downlight	Wan Spot	Compass Ø162	Kap Ø145 165mm Hole
					
SA.4010.3.001 h=220	SA.4010.3.102 h=242	SA.4010.3.003 h=166	SA.4010.3.004 h=105	SA.4010.3.009 h=275	SA.4010.3.017 h=285

SOFT ARCHITECTURE | OUT

USL 6060 for Modular Ceiling Designed By Flos Soft Architecture

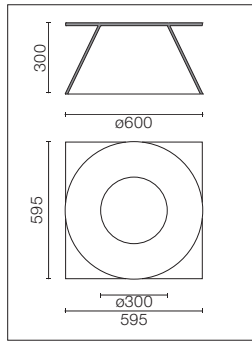

Architektonische Anwendung mit Soft Technologie. Ermöglicht die perfekte Integration der Flos architectural Produkte. Zur persönlichen Konfiguration können sie Lichtquellen in die Struktur einfügen. Fragen Sie das Verkaufsteam von Flos architectural.

Soft technology architectural application that permits perfect integration of the Flos architectural products. For personal configuration, you can add light points in the structure. Ask Flos architectural sales team.

Referenzen enthalten keine Produkte von Flos architectural.

References do not include Flos architectural products.

SA.4009.3.001
SA.4009.3.102
SA.4009.3.003

SA.4009.3.004
SA.4009.3.009
SA.4009.3.017

Empfohlene Produkte von Flos architectural / Flos architectural Recommended Products

Light Sniper	Easy Kap Ø105	Wan Downlight	Wan Spot	Compass Ø162	Kap Ø145 165mm Hole
SA.4009.3.001 h=165	SA.4009.3.102 h=187	SA.4009.3.003 h=111	SA.4009.3.004 h=50	SA.4009.3.009 h=220	SA.4009.3.017 h=230



Apps



G-O In



Teardrop

Small / Medium / Large



USO

USO Kap 105 / 145



USO 332



USO 700



USO 800



USO 1000



USO 1400



USO Cove Lighting

USO 900 Cove Lighting



USO 1700 Cove Lighting



USO 2200 Cove Lighting



USO 2500 Cove Lighting



USO 100 50 Cove Lighting



USO 140 90 Cove Lighting



Round Light

Small / Medium / Large



Square Light

Small / Large



Vertical Light

Small / Large



USB Round

USB Round 1L



USB Round 1L W-W



USB Round 2L



USB Round 2L W-W



USB Square

USB Square 1L



USB Square 1L W-W



USB Square 2L



USB Square 2L W-W



Apps Designed By Jorge Herrera

Light Source: LED Array 4W - 350 lm - 4000K/CRI 80

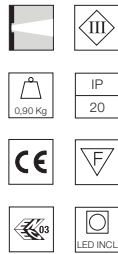
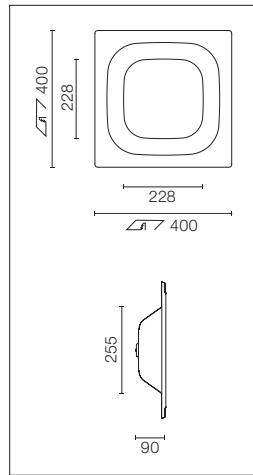

Einbau-Hinweisleuchte für Innenräume. Netzteil nicht eingeschlossen: Konstantstrom-Netzgerät mit 350mA. 220/240V, 50/60Hz.

Recessed sign luminaire for indoor application. Power supply source not included: continuous current power supply of 350mA. 220/240V, 50/60Hz.

- 90° DIR**
 SA.5061.3.076
 SA.5061.3.0OG
 SA.5061.3.0V3

- 45° DIR**
 SA.5062.3.076
 SA.5062.3.0OG
 SA.5062.3.0V3

- WC Ladies**
 SA.5063.3.076
 SA.5063.3.0OG
 SA.5063.3.0V3

- WC Men**
 SA.5064.3.076
 SA.5064.3.0OG
 SA.5064.3.0V3

- WC**
 SA.5065.3.076
 SA.5065.3.0OG
 SA.5065.3.0V3

- Bar**
 SA.5066.3.076
 SA.5066.3.0OG
 SA.5066.3.0V3

- Restaurant**
 SA.5067.3.076
 SA.5067.3.0OG
 SA.5067.3.0V3

- Elevator**
 SA.5068.3.076
 SA.5068.3.0OG
 SA.5068.3.0V3

- Info**
 SA.5069.3.076
 SA.5069.3.0OG
 SA.5069.3.0V3

- Stairs**
 SA.5070.3.076
 SA.5070.3.0OG
 SA.5070.3.0V3

Elektrisch / Electrical
60.8402

Signalleuchten
Signs

90° DIR



WC



Info



45° DIR



Bar



Stairs



WC Ladies



Restaurant



* Your Custom ID



WC Men



Elevator



Perimetrales Licht
Peripheral Lighting Colours

- 76 Weiss
 76 White

- OG Orange
 OG Orange

- V3 Violett
 V3 Violet



* Für eine persönliche farb- und piktogrammkonfiguration der leuchte bitte mit dem verkaufsteam von Flos architectural in verbindung setzen.
For a personal colour scheme and sign pictogram please ask the Flos architectural sales staff.



reddot design award
winner 2012

Apps Emergency Designed By Jorge Herrera

Light Source: LED Array 4W - 350 lm - 4000K/CRI 80

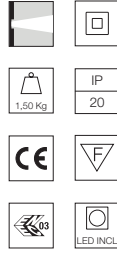
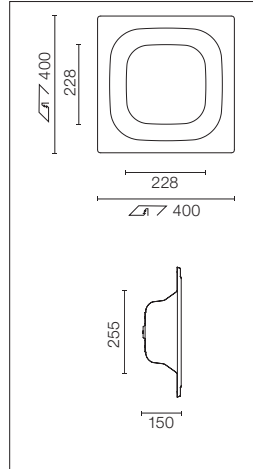

Einbau-Hinweisleuchte für die Notbeleuchtung von Innenräumen. Netzteil und Notbeleuchtungsgerät eingeschlossen. Autonomie 4 Stunden, Lichtstrom 80%.

Recessed emergency sign luminaire for indoor application. Power supply source and emergency gear included. 4-hour autonomy, 80% Flow.

- 90° DIR** SA.5071.3.076
- Exit Right** SA.5073.3.076
- Exit** SA.5075.3.076
- Fire Hose** SA.5077.3.076

- 45° DIR** SA.5072.3.076
- Exit Left** SA.5074.3.076
- Extinguisher** SA.5076.3.076
- Fire Alarm** SA.5078.3.076

Signalleuchten
Signs

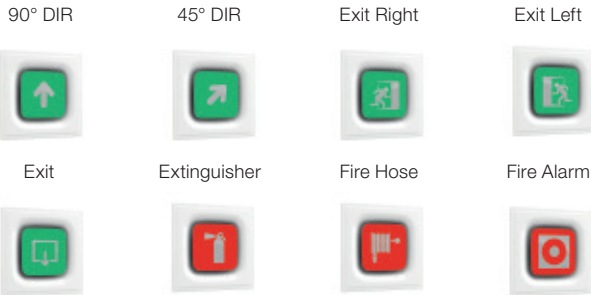

G-O In Designed By Jorge Herrera

Light Source: Top LED 1,2W - 24V - 105 lm - 3000K/CRI 90

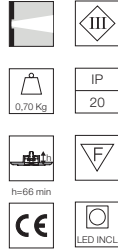
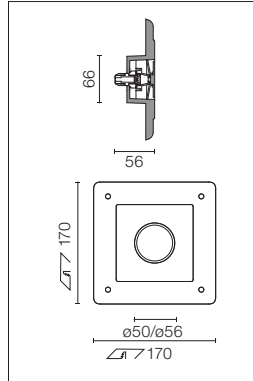

Einbau-Hinweisleuchte für Innenräume. Netzteil nicht eingeschlossen: Elektronischer Transformator für LED mit beständiger Spannung (24V). 220/240V, 50/60Hz. Netzkabel 1000mm eingeschlossen.

Recessed sign luminaire for indoor application. Power supply source not included: electronic transformer with constant voltage (24V) for LED. 220/240V, 50/60Hz. It includes 1000mm power supply cable.

Weiss Licht / White Light
SA.5100.1A
Amber Licht / Amber Light
SA.5101.1A
Blau Licht / Blue Light
SA.5102.1A

Elektrisch / Electrical
8W
60.9157

**Perimetrales Licht
Lighting Colours**



Achten Sie auf die korrekte Polung (+-) Rot+/Schwarz.

Ensure correct polarity (+-) Red +/- Black.

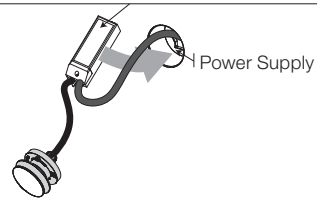

reddot design award
winner 2013

Teardrop Small Designed By Calvi Brambilla

Light Source: LED QR-CBC-51 1xGU5.3

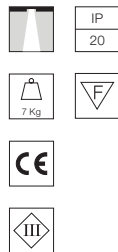
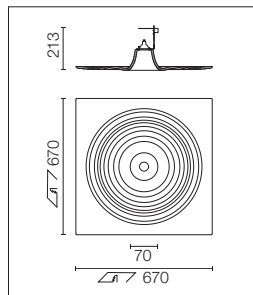
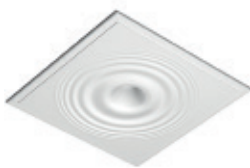

Einbauleuchte für 12 V LED-Retrofit-Lampe. Transformator mit Fernbedienung nicht eingeschlossen: Elektronischer Transformator 12V. 220/240V, 50/60Hz mit trailing edge Dimmer.

Recessed luminaire for 12V LED Retrofit lamp. Remote transformer not included: electronic transformer 12V. 220/240V, 50/60Hz. Adjustable by means of "leading and trailing edge".

SA.1039.1

Elektrisch / Electrical
50/70W
60.9398
105W
60.9424

Teardrop Medium Designed By Calvi Brambilla

Light Source: TC-DEL 2xG24q - 26W

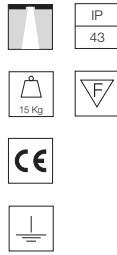
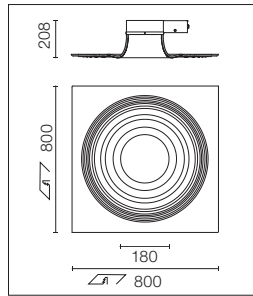
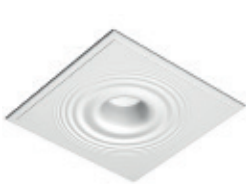

Einbauleuchte für Leuchtstofflampe. Vorschaltgeräte 220-240V / 50-60Hz ohne Dimmer eingeschlossen.

Recessed luminaire for fluorescent lamp. Non-dimmable ballasts 220-240V / 50-60Hz integrated.

SA.1040.1

Teardrop Large Designed By Calvi Brambilla

Light Source: TC-L 4x2G11 - 18W

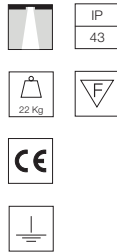
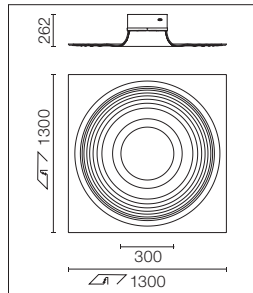
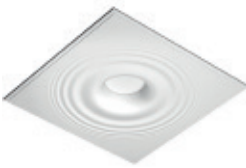

Einbauleuchte für Leuchtstofflampe. Vorschaltgeräte 220-240V / 50-60Hz ohne Dimmer eingeschlossen.

Recessed luminaire for fluorescent lamp. Non-dimmable ballasts 220-240V / 50-60Hz integrated.

SA.1041.1

USO Kap 105 Designed By Flos Soft Architecture

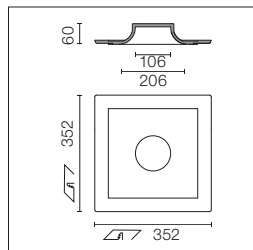
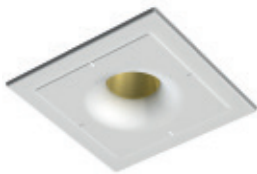

Architektonische Anwendung mit Soft Technologie. Ermöglicht die perfekte Integration der Flos architectural Produkte. Zur persönlichen Konfiguration können sie Lichtquellen in die Struktur einfügen. Fragen Sie das Verkaufsteam von Flos architectural.



Soft technology architectural application that permits perfect integration of the Flos architectural products. For personal configuration, you can add light points in the structure. Ask Flos architectural sales team.

Referenzen enthalten keine Produkte von Flos architectural.

References do not include Flos architectural products.

SA.1034.3.001
SA.1034.3.116

Empfohlene Produkte von Flos architectural / Flos architectural Recommended Products

Light Sniper	Kap Ø105*
	
SA.1034.3.001 h=225	SA.1034.3.116 h=290

* No Trim Rahmen eingeschlossen / Frame No Trim included
No Trim Rahmen nicht inbegriffen. Muss separat bestellt werden /
No Trim Frame excluded. To be ordered separately

USO Kap 145 Designed By Flos Soft Architecture

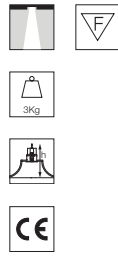
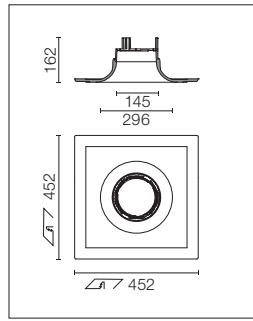
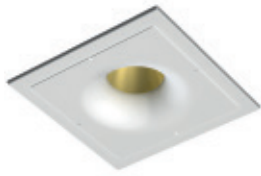

Architektonische Anwendung mit Soft Technologie. Ermöglicht die perfekte Integration der Flos architectural Produkte. Zur persönlichen Konfiguration können sie Lichtquellen in die Struktur einfügen. Fragen Sie das Verkaufsteam von Flos architectural.

Soft technology architectural application that permits perfect integration of the Flos architectural products. For personal configuration, you can add light points in the structure. Ask Flos architectural sales team.

Referenzen enthalten keine Produkte von Flos architectural.

References do not include Flos architectural products.

SA.1035.1

Empfohlene Produkte von Flos architectural / Flos architectural Recommended Products



* No Trim Rahmen eingeschlossen / Frame No Trim included

USO 332 Designed By Flos Soft Architecture

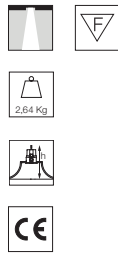
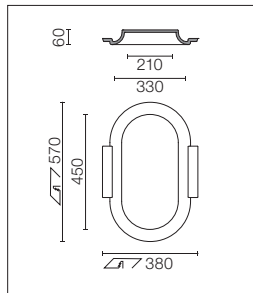

Architektonische Anwendung mit Soft Technologie für Moduldecken. Ermöglicht die perfekte Integration der Flos architectural Produkte. Zur persönlichen Konfiguration können sie Lichtquellen in die Struktur einfügen. Fragen Sie das Verkaufsteam von Flos architectural.

Soft technology architectural application for modular ceilings that permits perfect integration of the Flos architectural products. For personal configuration, you can add light points in the structure. Ask Flos architectural sales team.

Referenzen enthalten keine Produkte von Flos architectural.

References do not include Flos architectural products.

SA.1001.3.001
SA.1001.3.102
SA.1001.3.003
SA.1001.3.004
SA.1001.3.009

SA.1001.3.014
SA.1001.3.116

Empfohlene Produkte von Flos architectural / Flos architectural Recommended Products

Light Sniper	Easy Kap Ø105	Wan Downlight	Wan Spot	Compass Ø162	Kap Ø145*	Kap Ø105*
SA.1001.3.001 h=225	SA.1001.3.102 h=247	SA.1001.3.003 h=171	SA.1001.3.004 h=110	SA.1001.3.009 h=280	SA.1001.3.014 h=290	SA.1001.3.116 h=290

* No Trim Rahmen eingeschlossen / Frame No Trim included
No Trim Rahmen nicht inbegriffen. Muss separat bestellt werden /
No Trim Frame excluded. To be ordered separately

SOFT ARCHITECTURE | IN

USO 700 Designed By Flos Soft Architecture

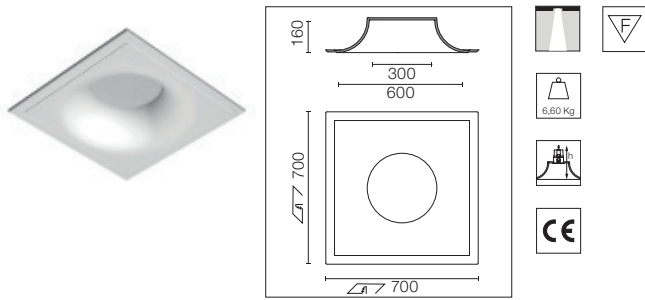

Architektonische Anwendung mit Soft Technologie. Ermöglicht die perfekte Integration der Flos architectural Produkte. Zur persönlichen Konfiguration können sie Lichtquellen in die Struktur einfügen. Fragen Sie das Verkaufsteam von Flos architectural.

Soft technology architectural application that permits perfect integration of the Flos architectural products. For personal configuration, you can add light points in the structure. Ask Flos architectural sales team.







Referenzen enthalten keine Produkte von Flos architectural.

References do not include Flos architectural products.

SA.1002.3.001
SA.1002.3.102
SA.1002.3.003
SA.1002.3.004
SA.1002.3.009

SA.1002.3.014
SA.1002.3.116

Empfohlene Produkte von Flos architectural / Flos architectural Recommended Products

Light Sniper	Easy Kap Ø105	Wan Downlight	Wan Spot	Compass Ø162	Kap Ø145*	Kap Ø105*
						
SA.1002.3.001 H=325	SA.1002.3.102 H=347	SA.1002.3.003 H=271	SA.1002.3.004 H=210	SA.1002.3.009 H=380	SA.1002.3.014 H=390	SA.1002.3.116 H=390

* No Trim Rahmen eingeschlossen / Frame No Trim included
No Trim Rahmen nicht inbegriffen. Muss separat bestellt werden /
No Trim Frame excluded. To be ordered separately

USO 800 Designed By Flos Soft Architecture

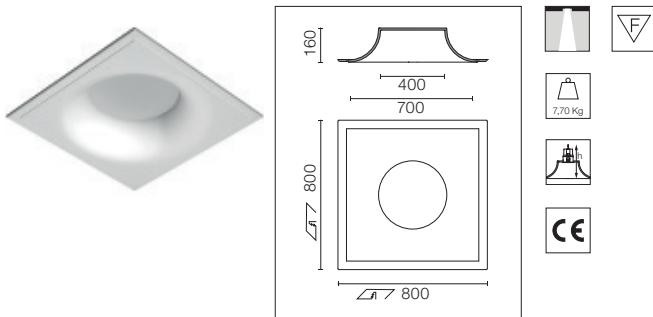

Architektonische Anwendung mit Soft Technologie. Ermöglicht die perfekte Integration der Flos architectural Produkte. Zur persönlichen Konfiguration können sie Lichtquellen in die Struktur einfügen. Fragen Sie das Verkaufsteam von Flos architectural.

Soft technology architectural application that permits perfect integration of the Flos architectural products. For personal configuration, you can add light points in the structure. Ask Flos architectural sales team.







Referenzen enthalten keine Produkte von Flos architectural.

References do not include Flos architectural products.

SA.1003.3.001
SA.1003.3.102
SA.1003.3.003

SA.1003.3.004
SA.1003.3.009
SA.1003.3.017

Empfohlene Produkte von Flos architectural / Flos architectural Recommended Products

Light Sniper	Easy Kap Ø105	Wan Downlight	Wan Spot	Compass Ø162	Kap Ø145 165mm Hole
					
SA.1003.3.001 H=325	SA.1003.3.102 H=347	SA.1003.3.003 H=271	SA.1003.3.004 H=210	SA.1003.3.009 H=380	SA.1003.3.017 H=390

SOFT ARCHITECTURE | IN

USO 1000 Designed By Flos Soft Architecture

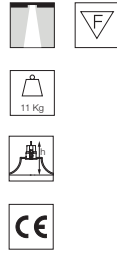
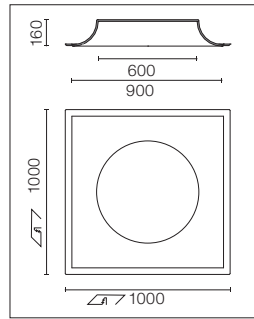
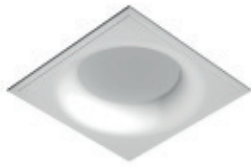

Architektonische Anwendung mit Soft Technologie. Ermöglicht die perfekte Integration der Flos architectural Produkte.
Zur persönlichen Konfiguration können Sie Lichtquellen in die Struktur einfügen. Fragen Sie das Verkaufsteam von Flos architectural.

Soft technology architectural application that permits perfect integration of the Flos architectural products.
For personal configuration, you can add light points in the structure. Ask Flos architectural sales team.







Referenzen enthalten keine Produkte von Flos architectural.

References do not include Flos architectural products.

SA.1004.3.001
SA.1004.3.102
SA.1004.3.003

SA.1004.3.004
SA.1004.3.009
SA.1004.3.017

Empfohlene Produkte von Flos architectural / Flos architectural Recommended Products

Light Sniper	Easy Kap Ø105	Wan Downlight	Wan Spot	Compass Ø162	Kap Ø145 165mm Hole
					
SA.1004.3.001 H=325	SA.1004.3.102 H=347	SA.1004.3.003 H=271	SA.1004.3.004 H=210	SA.1004.3.009 H=380	SA.1004.3.017 H=390

USO 1400 Designed By Flos Soft Architecture

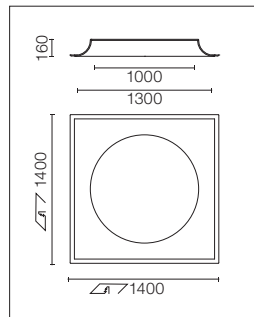

Architektonische Anwendung mit Soft Technologie. Ermöglicht die perfekte Integration der Flos architectural Produkte.
Zur persönlichen Konfiguration können Sie Lichtquellen in die Struktur einfügen. Fragen Sie das Verkaufsteam von Flos architectural.

Soft technology architectural application that permits perfect integration of the Flos architectural products.
For personal configuration, you can add light points in the structure. Ask Flos architectural sales team.







Referenzen enthalten keine Produkte von Flos architectural.

References do not include Flos architectural products.

SA.1005.3.001
SA.1005.3.102
SA.1005.3.003

SA.1005.3.004
SA.1005.3.009
SA.1005.3.017

Empfohlene Produkte von Flos architectural / Flos architectural Recommended Products

Light Sniper	Easy Kap Ø105	Wan Downlight	Wan Spot	Compass Ø162	Kap Ø145 165mm Hole
					
SA.1005.3.001 H=325	SA.1005.3.102 H=347	SA.1005.3.003 H=271	SA.1005.3.004 H=210	SA.1005.3.009 H=380	SA.1005.3.017 H=390

SOFT ARCHITECTURE | IN

USO 900 Cove Lighting Designed By Flos Soft Architecture

Light Source: T5 FH 4xG5 - 21W - 7600 lm / T5 FQ 4xG5 - 39W - 12400 lm / Cold Cathode 90W - 3x30W - 7776 lm - 3000K/CRI 85
LED White 75,6W - 21x3,6W - 7875 lm - 3000K/CRI 90 / LED RGB 75,6W - 21x3,6W

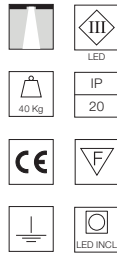
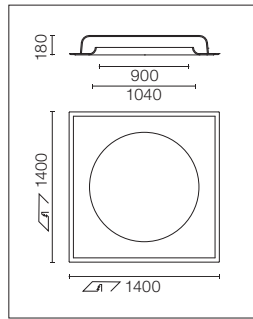

Deckeneinbauleuchte. Direkte Beleuchtung mit Leuchtstofflampen, Kaltkathode oder LED. Betriebsgeräte bei den LED-Versionen nicht eingeschlossen.

Siehe LED-Steuergeräte.

Recessed ceiling luminaire. Direct lighting with fluorescent, cold cathode or LED lamps. Control gear not included in LED versions.

See LED LED drivers.

T5 FH

Dimmable 1-10V
SA.1006.4.11V
Dimmable Dali
SA.1006.4.1DA

Cold Cathode
SA.1006.4.300

***LED RGB**
SA.1006.6D100

T5 FQ

Non Dimmable
SA.1006.4.200
Dimmable 1-10V
SA.1006.4.21V
Dimmable Dali
SA.1006.4.2DA

***LED White**
SA.1006.5D110

USO 1700 Cove Lighting Designed By Flos Soft Architecture

Light Source: T5 FH 8xG5 - 21W - 15200 lm / T5 FQ 8xG5 - 39W - 24800 lm / Cold Cathode 161W - 4x40W - 13824 lm - 3000K/CRI 85
LED White 136,8W - 38x3,6W - 14250 lm - 3000K/CRI 90 / LED RGB 136,8W - 38x3,6W

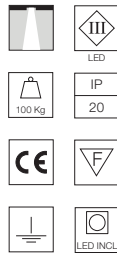
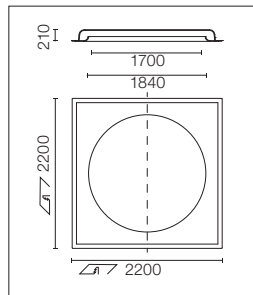

Deckeneinbauleuchte. Direkte Beleuchtung mit Leuchtstofflampen, Kaltkathode oder LED. Betriebsgeräte bei den LED-Versionen nicht eingeschlossen.

Siehe LED-Steuergeräte.

In zwei teilen geliefert.

Recessed ceiling luminaire. Direct lighting with fluorescent, cold cathode or LED lamps. Control gear not included in LED versions.

See LED LED drivers.

Delivered in two pieces.

T5 FH

Dimmable 1-10V
SA.1007.4.11V
Dimmable Dali
SA.1007.4.1DA

Cold Cathode
SA.1007.4.300

***LED RGB**
SA.1007.6D100

T5 FQ

Non Dimmable
SA.1007.4.200
Dimmable 1-10V
SA.1007.4.21V
Dimmable Dali
SA.1007.4.2DA

***LED White**
SA.1007.5D110

SOFT ARCHITECTURE | IN

USO 2200 Cove Lighting Designed By Flos Soft Architecture

Light Source: T5 FH 8xG5 - 28W - 20800 lm / T5 FQ 8xG5 - 54W - 35600 lm / Cold Cathode 205W - 4x51W - 17568 lm - 3000K/CRI 85
LED White 180W - 50x3,6W - 18750 lm - 3000K/CRI 90 / LED RGB 180W - 50x3,6W

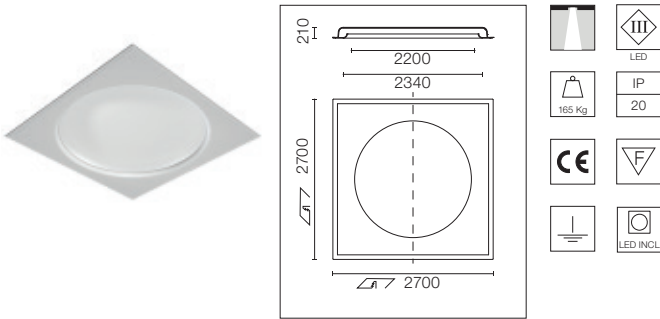

Deckeneinbauleuchte. Direkte Beleuchtung mit Leuchtstofflampen, Kaltkathode oder LED. Betriebsgeräte bei den LED-Versionen nicht eingeschlossen.

Recessed ceiling luminaire. Direct lighting with fluorescent, cold cathode or LED lamps. Control gear not included in LED versions.

Siehe LED-Steuergeräte.

See LED LED drivers.

In zwei teilen geliefert.

Delivered in two pieces.

T5 FH

Dimmable 1-10V
SA.1008.4.11V
Dimmable Dali
SA.1008.4.1DA

T5 FQ

Non Dimmable
SA.1008.4.200
Dimmable 1-10V
SA.1008.4.21V
Dimmable Dali
SA.1008.4.2DA

Cold Cathode

SA.1008.4.300

*LED RGB

SA.1008.6D100

*LED White

SA.1008.5D110

USO 2500 Cove Lighting Designed By Flos Soft Architecture

Light Source: T5 FH 8xG5 - 28W - 20800 lm / T5 FQ 8xG5 - 54W - 35600 lm / Cold Cathode 230W - 19728 lm - 3000K/CRI 85
LED White 194W - 54x3,6W - 20250 lm - 3000K/CRI 90 / LED RGB 194W - 54x3,6W

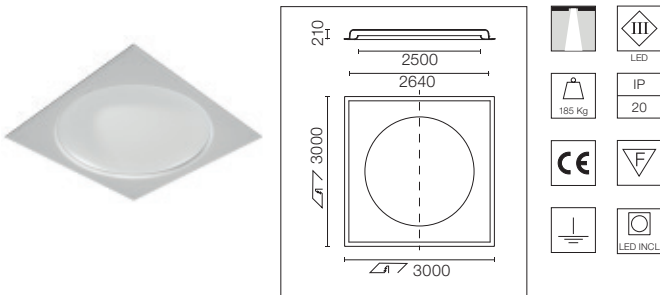

Deckeneinbauleuchte. Direkte Beleuchtung mit Leuchtstofflampen, Kaltkathode oder LED. Betriebsgeräte bei den LED-Versionen nicht eingeschlossen.

Recessed ceiling luminaire. Direct lighting with fluorescent, cold cathode or LED lamps. Control gear not included in LED versions.

Siehe LED-Steuergeräte.

See LED LED drivers.

In zwei teilen geliefert.

Delivered in two pieces.

T5 FH

Dimmable 1-10V
SA.1009.4.11V
Dimmable Dali
SA.1009.4.1DA

T5 FQ

Non Dimmable
SA.1009.4.200
Dimmable 1-10V
SA.1009.4.21V
Dimmable Dali
SA.1009.4.2DA

Cold Cathode

SA.1009.4.300

*LED RGB

SA.1009.6D100

*LED White

SA.1009.5D110

SOFT ARCHITECTURE | IN

USO 100 50 Cove Lighting Designed By Flos Soft Architecture

Light Source: T5 FH 4xG5 - 14W - 4800 lm / T5 FQ 4xG5 - 24W - 7000 lm / Cold Cathode 58W - 3x19W - 4968 lm - 3000K/CRI 85
LED White 57,6W - 16x3,6W - 6000 lm - 3000K/CRI 90 / LED RGB 57,6W - 16x3,6W

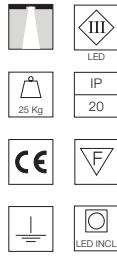
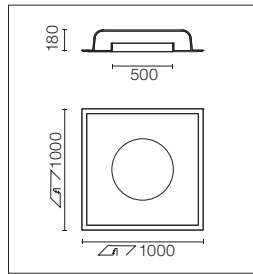

Deckeneinbauleuchte. Direkte Beleuchtung mit Leuchtstofflampen, Kaltkathode oder LED. Betriebsgeräte bei den LED-Versionen nicht eingeschlossen.

Recessed ceiling luminaire. Direct lighting with fluorescent, cold cathode or LED lamps. Control gear not included in LED versions.

Siehe LED-Steuergeräte.

See LED LED drivers.

T5 FH

Non Dimmable
SA.1010.4.100

T5 FQ

Non Dimmable
SA.1010.4.200

Cold Cathode

SA.1010.4.300

*LED White

SA.1010.5D110

*LED RGB

SA.1010.6D100

USO 140 90 Cove Lighting Designed By Flos Soft Architecture

Light Source: T5 FH 4xG5 - 21W - 7600 lm / T5 FQ 4xG5 - 39W - 12400 lm / Cold Cathode 90W - 3x30W - 7776 lm - 3000K/CRI 85
LED White 75,6W - 21x3,6W - 7805 lm - 3000K/CRI 90 / LED RGB 75,6W - 21x3,6W

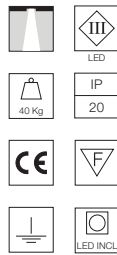
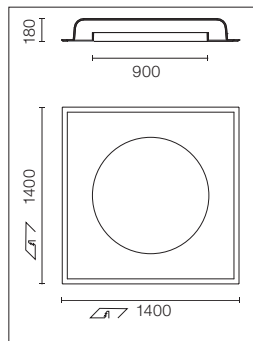

Deckeneinbauleuchte. Direkte Beleuchtung mit Leuchtstofflampen, Kaltkathode oder LED. Betriebsgeräte bei den LED-Versionen nicht eingeschlossen.

Recessed ceiling luminaire. Direct lighting with fluorescent, cold cathode or LED lamps. Control gear not included in LED versions.

Siehe LED-Steuergeräte.

See LED LED drivers.

In zwei teilen geliefert.

Delivered in two pieces.

T5 FH

Dimmable 1-10V
SA.1011.4.11V
Dimmable Dali
SA.1011.4.1DA

T5 FQ

Non Dimmable
SA.1011.4.200
Dimmable 1-10V
SA.1011.4.21V
Dimmable Dali
SA.1011.4.2DA

Cold Cathode

SA.1011.4.300

*LED White

SA.1011.5D110

*LED RGB

SA.1011.6D100

Round Light Small Designed By Flos Soft Architecture

Light Source: LED White 1W - 60 lm - 3000K/CRI > 90

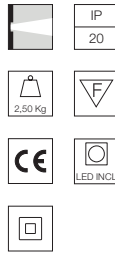
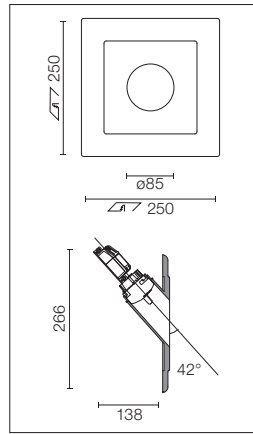

Einbau-Hinweisleuchte für Innenräume. Netzteil 100/240V eingeschlossen.

Recessed sign luminaire for indoor application. 100/240V power supply source included.

SA.3010.1C

Round Light Medium Designed By Flos Soft Architecture

Light Source: LED White 7W - 720 lm - 3000K/CRI > 90

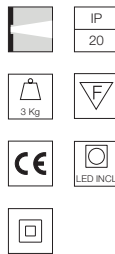
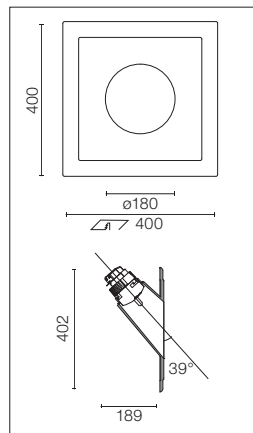

Einbau-Hinweisleuchte für Innenräume. Netzteil 100/240V eingeschlossen.

Recessed sign luminaire for indoor application. 100/240V power supply source included.

SA.3011.1B

Round Light Large Designed By Flos Soft Architecture

Light Source: LED White 7W - 720 lm - 3000K/CRI > 90

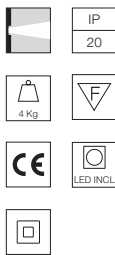
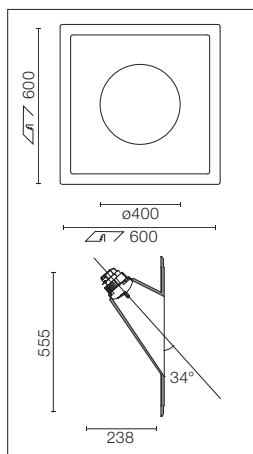

Einbau-Hinweisleuchte für Innenräume. Netzteil 100/240V eingeschlossen.

Recessed sign luminaire for indoor application. 100/240V power supply source included.

SA.3012.1B

Square Light Small Designed By Flos Soft Architecture

Light Source: LED White 1W - 60 lm - 3000K/CRI > 90

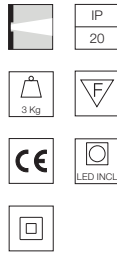
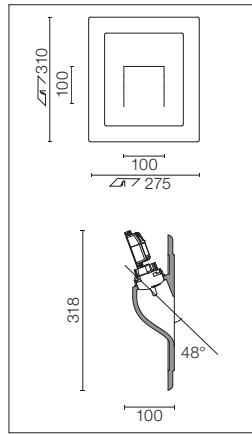

Einbau-Hinweisleuchte für Innenräume. Netzteil 100/240V eingeschlossen.

Recessed sign luminaire for indoor application. 100/240V power supply source included.

SA.3013.1C

Square Light Large Designed By Flos Soft Architecture

Light Source: LED White 7W - 720 lm - 3000K/CRI > 80

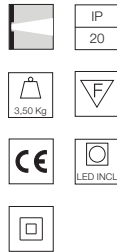
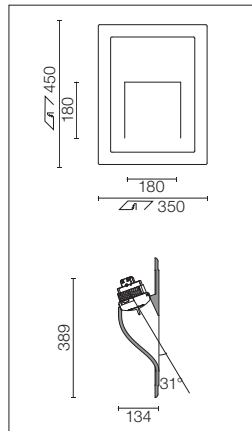

Einbau-Hinweisleuchte für Innenräume. Netzteil 100/240V eingeschlossen.

Recessed sign luminaire for indoor application. 100/240V power supply source included.

SA.3014.1B

Vertical Light Small Designed By Flos Soft Architecture

Light Source: LED White 1W - 60 lm - 3000K/CRI > 90

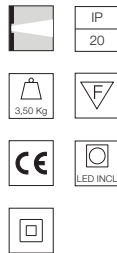
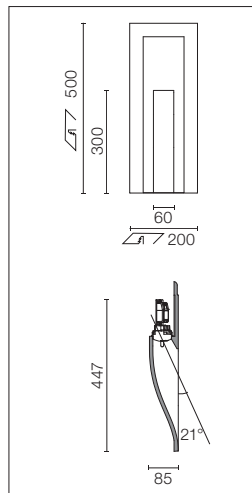

Einbau-Hinweisleuchte für Innenräume. Netzteil 100/240V eingeschlossen.

Recessed sign luminaire for indoor application. 100/240V power supply source included.

SA.3015.1C

Vertical Light Large Designed By Flos Soft Architecture

Light Source: LED White 1W - 60 lm - 3000K/CRI > 90

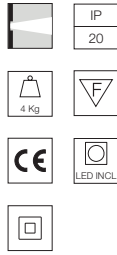
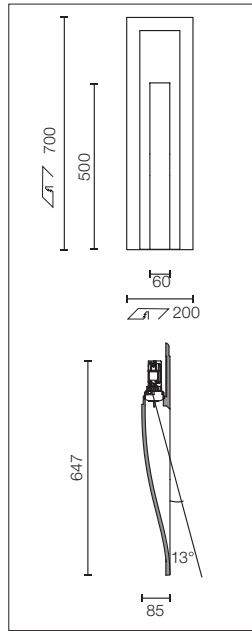

Einbau-Hinweisleuchte für Innenräume. Netzteil 100/240V eingeschlossen.

Recessed sign luminaire for indoor application. 100/240V power supply source included.

SA.3016.1C

USB Round 1L Designed By Flos Soft Architecture

Light Source: LED QR-CBC-51 1xGU5.3

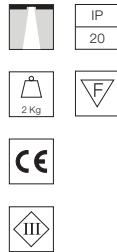
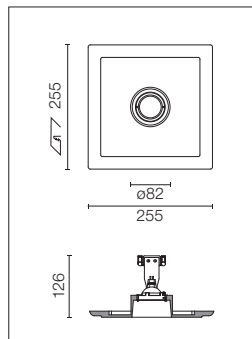

Einbauleuchte für 12 V LED-Retrofit-Lampe. 220/240V, 50/60Hz mit trailing edge Dimmer. Transformator mit Fernbedienung nicht eingeschlossen.

Recessed luminaire for 12V LED Retrofit lamp. 220/240V, 50/60Hz. Adjustable by means of "leading and trailing edge". Remote transformer not included.

SA.3017.1

Elektrisch / Electrical
50/70W
60.9398
105W
60.9424

Zubehör / Accessories

Blendfrei.40°-cut-off-zubehörring.

Anti-Glare.
40° cut-off accessory ring.



08.8270.00

USB Round 1L W-W Designed By Flos Soft Architecture

Light Source: LED QR-CBC-51 1xGU5.3

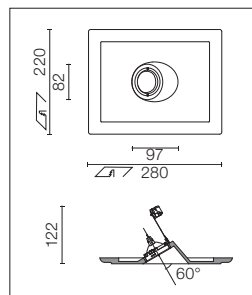

Einbauleuchte für 12 V LED-Retrofit-Lampe. 220/240V, 50/60Hz mit trailing edge Dimmer. Transformator mit Fernbedienung nicht eingeschlossen.

Recessed luminaire for 12V LED Retrofit lamp. 220/240V, 50/60Hz. Adjustable by means of "leading and trailing edge". Remote transformer not included.

SA.3019.1

Elektrisch / Electrical
50/70W
60.9398
105W
60.9424

USB Round 2L Designed By Flos Soft Architecture

Light Source: LED QR-CBC-51 2xGU5.3

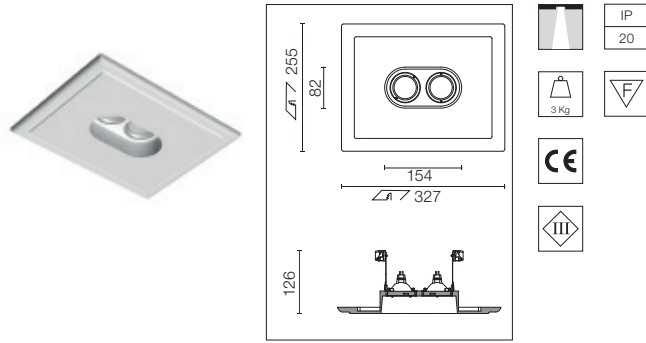

Einbauleuchte für 12 V LED-Retrofit-Lampe. 220/240V, 50/60Hz mit trailing edge Dimmer. Transformator mit Fernbedienung nicht eingeschlossen.

Recessed luminaire for 12V LED Retrofit lamp. 220/240V, 50/60Hz. Adjustable by means of "leading and trailing edge". Remote transformer not included.

SA.3018.1

Elektrisch / Electrical
50/70W
60.9398
105W
60.9424

Zubehör / Accessories

Blendfrei.40°-cut-off-zubehörring.

Anti-Glare.
40° cut-off accessory ring.



USB Round 2L W-W Designed By Flos Soft Architecture

Light Source: LED QR-CBC-51 2xGU5.3

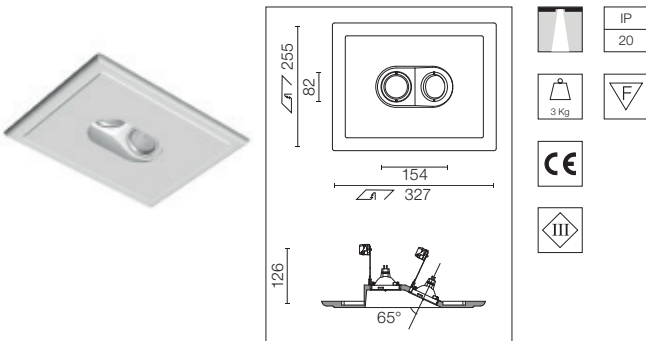

Einbauleuchte für 12 V LED-Retrofit-Lampe. 220/240V, 50/60Hz mit trailing edge Dimmer. Transformator mit Fernbedienung nicht eingeschlossen.

Recessed luminaire for 12V LED Retrofit lamp. 220/240V, 50/60Hz. Adjustable by means of "leading and trailing edge". Remote transformer not included.

SA.3020.1

Elektrisch / Electrical
50/70W
60.9398
105W
60.9424

USB Square 1L Designed By Flos Soft Architecture

Light Source: LED QR-CBC-51 1xGU5.3

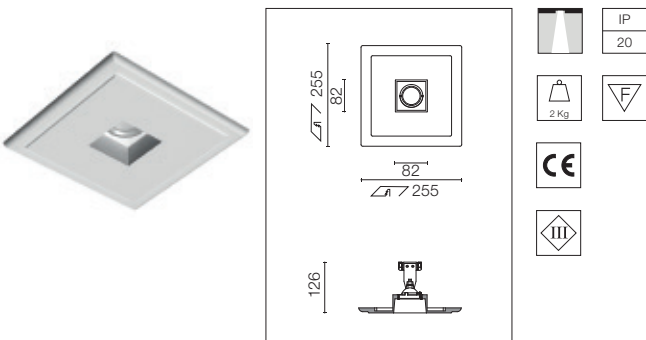

Einbauleuchte für 12 V LED-Retrofit-Lampe. 220/240V, 50/60Hz mit trailing edge Dimmer. Transformator mit Fernbedienung nicht eingeschlossen.

Recessed luminaire for 12V LED Retrofit lamp. 220/240V, 50/60Hz. Adjustable by means of "leading and trailing edge". Remote transformer not included.

SA.3021.1

Elektrisch / Electrical
50/70W
60.9398
105W
60.9424

Zubehör / Accessories

Blendfrei.40°-cut-off-zubehörring.

Anti-Glare.
40° cut-off accessory ring.



USB Square 1L W-W Designed By Flos Soft Architecture

Light Source: LED QR-CBC-51 1xGU5.3

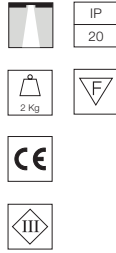
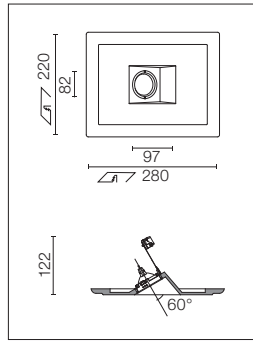

Einbauleuchte für 12 V LED-Retrofit-Lampe. 220/240V, 50/60Hz mit trailing edge Dimmer. Transformator mit Fernbedienung nicht eingeschlossen.

Recessed luminaire for 12V LED Retrofit lamp. 220/240V, 50/60Hz. Adjustable by means of "leading and trailing edge". Remote transformer not included.

SA.3009.1

Elektrisch / Electrical
50/70W
60.9398
105W
60.9424

USB Square 2L Designed By Flos Soft Architecture

Light Source: LED QR-CBC-51 2xGU5.3

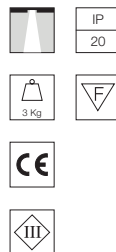
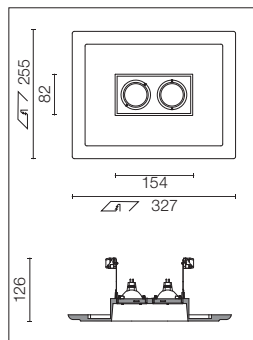

Einbauleuchte für 12 V LED-Retrofit-Lampe. 220/240V, 50/60Hz mit trailing edge Dimmer. Transformator mit Fernbedienung nicht eingeschlossen.

Recessed luminaire for 12V LED Retrofit lamp. 220/240V, 50/60Hz. Adjustable by means of "leading and trailing edge". Remote transformer not included.

SA.3022.1

Elektrisch / Electrical
50/70W
60.9398
105W
60.9424

Zubehör / Accessories

Blendfrei.40°-cut-off-zubehörring.

Anti-Glare.
40° cut-off accessory ring.



08.8270.00

USB Square 2L W-W Designed By Flos Soft Architecture

Light Source: LED QR-CBC-51 2xGU5.3

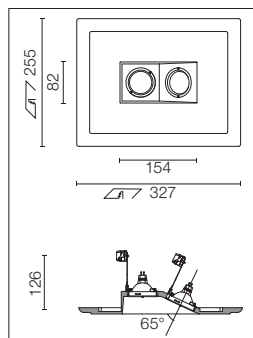

Einbauleuchte für 12 V LED-Retrofit-Lampe. 220/240V, 50/60Hz mit trailing edge Dimmer. Transformator mit Fernbedienung nicht eingeschlossen.

Recessed luminaire for 12V LED Retrofit lamp. 220/240V, 50/60Hz. Adjustable by means of "leading and trailing edge". Remote transformer not included.

SA.3023.1

Elektrisch / Electrical
50/70W
60.9398
105W
60.9424

SOFT ARCHITECTURE | IN

LED DRIVERS

For: USO Cove Lighting: USO 900 C.L., USO 1700 C.L., USO 2200 C.L., USO 2500 C.L., USO 100 50 C.L., USO 140 90 C.L.

Non Dimmable

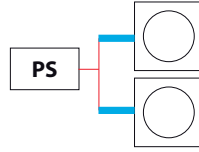

Verkabelung Wiring

500-mm-Zuführungskabel für weiße LED-Module mit Schnellverbindung.
Elektronische Stromversorgung nicht inbegriffen.

500mm feed cable for white LED modules with fast connection. Electronic power supply not included.

White

06.1016.00

RGB

06.1049.00

Dimmable 1-10V

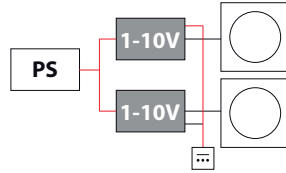

Dimmbare Interfaces Dimmable Interface

Dimmbares 1-10V-Interface mit 500-mm-Zuführungskabel für weiße LED-Module mit Schnellverbindung.
Elektronische Stromversorgung nicht inbegriffen.

1-10V dimmable interface with 500mm feed cable for white LED modules with fast connection.
Electronic power supply not included.

White

06.1022.00

1-10V

Dimmbare Interfaces Dimmable Interfaces

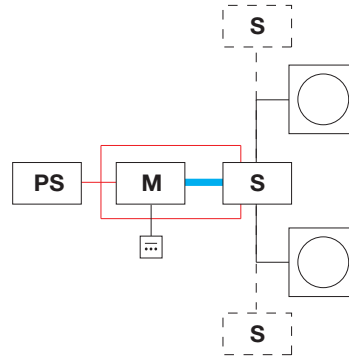

DALI Master-Interface mit einem 5 poligen Verteiler und einem 500-mm- Zuführungskabel für einfache Verbindung. Kann ein USO-Modul steuern. Falls die Installation mehrere USO-Module umfasst, muss das Signal mit Slave-Interfaces erweitert werden. Elektronische Stromversorgung nicht inbegriffen.

DALI Master interface with one 5 pole distributor and one 500mm feed cable for easy connection. It's able to control one USO. If more USOs are in the same installation it's necessary to expand the signal with Slave interfaces. Electronic power supply not included.

White

06.1019.00

M

RGB

06.1012.00

M

DMX Master-Interface mit einem 5 poligen Verteiler und einem 500-mm- Zuführungskabel für einfache Verbindung. Kann ein USO-Modul steuern. Falls die Installation mehrere USO-Module umfasst, muss das Signal mit Slave-Interfaces erweitert werden. Elektronische Stromversorgung nicht inbegriffen.

DMX Master interface with one 5 pole distributor and one 500mm feed cable for easy connection. It's able to control one USO. If more USOs are in the same installation it's necessary to expand the signal with Slave interfaces. Electronic power supply not included.

06.1005.00

M

Radiofrequenz (RF) RGB Master-Interface mit einem 5 poligen Verteiler und einem 500-mm- Zuführungskabel für einfache Verbindung. Wand-Transmitter für integrierte Farbänderung. Kann ein USO-Modul steuern. Falls die Installation mehrere USO-Module umfasst, muss das Signal mit Slave-Interfaces erweitert werden. Elektronische Stromversorgung nicht inbegriffen.

Radio Frequency (RF) RGB Master interface with one 5 pole distributor and one 500mm feed cable for easy connection. Wall transmitter to make color changing integrated. It's able to control one USO. If more USOs are in the same installation it's necessary to expand the signal with Slave interfaces. Electronic power supply not included.

06.1013.00

M

— Vom Installateur zur Verfügung gestellt / Installer provides

SOFT ARCHITECTURE | IN

LED DRIVERS

For: USO Cove Lighting: USO 900 C.L., USO 1700 C.L., USO 2200 C.L., USO 2500 C.L., USO 100 50 C.L., USO 140 90 C.L.

Dimmbare Interfaces Dimmable Interfaces

Slave-Interface zur Erweiterung des Steuersignals mit zwei 500-mm-Zuführungskabeln für einfache Verbindung zu erweitern. Kann das Master-Signal auf zwei USO-Module erweitern. Elektronische Stromversorgung nicht inbegriffen.

Slave interface to expand the control signal with two 500mm feed cables for easy connection. It's able to expand the Master signal in two USOs. Electronic power supply not included.

	White	RGB
	06.1022.00 S	06.1014.00 S
2-Meter-Verlängerungskabel für LED-Module mit einfache Verbindung. Können verbunden werden, um die Länge zu vergrößern. Max. 20 Meter.	08.8297.00 —	08.8298.00 —
2 meters prolongation cable for LED modules with fast connection. Can be connected with each other to greater length. 20 meters max.		

Stromversorgung / Power Supply

Elektronische 100W / Electronic 100W

Stromversorgung / Power supply
LED. 100W – 24V. 100-240V, 50-60Hz.

PS

60.9443

Elektronische 200W / Electronic 200W

Stromversorgung / Power supply
LED. 200W – 24V. 100-240V, 50-60Hz.

PS

60.9352

Elektronische 120W / Electronic 120W

Stromversorgung / Power supply
LED. 120W – 24V. 100-240V, 50-60Hz.

60.9407

Elektronische 240W / Electronic 240W

Stromversorgung / Power supply
LED. 240W – 24V. 100-240V, 50-60Hz.

60.8268

Installationstabellen Installation Guidelines

REFERENCE	POWER (W)	LED MODULES	POWER SUPPLY UNITS	MAX. Distance			LED WHITE			RGB		
				PS-	M-S		NO DIM	1-10V	DALI	DALI	DMX	RF
USO 100 50 Cove Lighting WHT: SA.1010.5D110 RGB: SA.1010.6D110	58	12 + 4 for corners (16)	100W 60.9443		M-S		2x (06.1016.00) FEED CABLE	06.1016.00 FEED CABLE + 06.1022.00 MASTER 1-10V	06.1016.00 FEED CABLE + 06.1019.00 DALI MASTER	06.1012.00 MASTER DALI + 06.1014.00 SLAVE	06.1005.00 MASTER DMX + 06.1014.00 SLAVE	06.1013.00 MASTER RF + 06.1014.00 SLAVE
USO 140 90 Cove Lighting WHT: SA.1011.5D110 RGB: SA.1011.6D110	76	17 + 4 for corners (21)						2x (06.1016.00) FEED CABLE + 06.1022.00 MASTER 1-10V	2x (06.1016.00) FEED CABLE + 06.1019.00 DALI MASTER			
USO 900 Cove Lighting WHT: SA.1006.5D110 RGB: SA.1006.6D110												
USO 1700 Cove Lighting WHT: SA.1007.5D110 RGB: SA.1007.6D110	137	30 + 8 for corners (38)	200W 60.9352		M-S		4x (06.1016.00) FEED CABLE	3x (06.1016.00) FEED CABLE + 2x (06.1022.00) MASTER 1-10V	3x (06.1016.00) FEED CABLE + 1x (06.1019.00) DALI MASTER + 1x (06.1020.00) SLAVE WHITE + 2x (06.1022.00) REPEATER PWM	06.1012.00 MASTER DALI + 2x (06.1014.00)* SLAVE	06.1005.00 MASTER DMX + 2x (06.1014.00)* SLAVE	06.1013.00 MASTER RF + 2x (06.1014.00)* SLAVE
USO 2200 Cove Lighting WHT: SA.1008.5D110 RGB: SA.1008.6D110	180	38 + 12 for corners (50)						240W 60.8268				
USO 2500 Cove Lighting WHT: SA.1009.5D110 RGB: SA.1009.6D110	194	42 + 12 for corners (54)										

* For USO 2500 Cove Lighting RGB
1st Slave: 12 + 12 LED modules
2nd Slave: 10 + 10 +10 LED modules

Ausführlichere Informationen entnehmen Sie bitte dem Merkblatt. Für eine komplexere Installation wenden Sie sich an die technische Abteilung. / For more detailed information, please refer to the instruction sheet. For a more complex installation, please consult the technical department.



VERBUNDMERKMALE COMPOSITE CHARACTERISTICS



PHYSIKALISCHE EIGENSCHAFTEN

Wasserdichtheit

Das Material ist für alle Anwendungszwecke in Innenbereichen geeignet und absorbiert keine Feuchtigkeit, auch wenn überschüssige Feuchtigkeit vorhanden ist. Das Material darf nicht im Freien verwendet werden.

Test des Brandverhaltens für Bauprodukte

Das Soft-Architecture-Produkt ist als A1 oder A1fl klassifiziert, gemäß UNE-EN 13501-1: 07 und wurde gemäß den Verfahren der Normen UNE-EN ISO 1716:02 und UNE-EN ISO 1182:02 getestet.

Chemikalienbeständigkeit

Das Material darf keinen flüssigen Chemikalien oder geschmolzenen Kristallen ausgesetzt werden.

Wärmeisolierung

Der Wert der Wärmeleitfähigkeit des Materials darf 0,47 W/m. deg K nicht überschreiten.

Dichte

Das Material besitzt eine mittlere Dichte von 1323 Kg/m³.

Strukturelle Eigenschaften

Das Material muss die folgenden Eigenschaften besitzen (gemäß EN 13279-2:2006). Max. Biegebelastung: 139 N bei 7,2mm Dicke.
Druck: Maximale Druckfestigkeit größer sein als 10000N.
Härte: Shore-Härte C muss über 90 betragen.

MATERIALEIGENSCHAFTEN

Wasser-Ökoeffizienz

Für eine optimale Verarbeitbarkeit wird sauberes Trinkwasser in angemessenen Mengen verwendet.
Wasser wird zyklisch durch spezielle Filter wiederverwendet, um Umweltschäden vor der Entsorgung vorzubeugen.

Formtrennmittel

Es werden eigene Formtrennmittel integriert oder extern auf die Formoberfläche aufgebracht, um die Zykluszeit zu optimieren und ein einheitliches Oberflächenfinish zu erhalten. Diese Mittel dürfen keinen gegenteiligen Effekt auf die Oberfläche des produzierten Gegenstands haben.

DESIGN & HERSTELLUNG

Design

Für die Herstellung aller Komponenten wird modernste 3-D-Technologie verwendet. Sie werden mit einem vollständig dokumentierten Qualitätssicherungssystem designt und hergestellt, gemäß ISO 9001:2008.

QUALITÄTSKONTROLLE

Allgemein

Alle Komponenten werden individuell geprüft, um Oberflächen- oder Herstellungsfehler zu vermeiden.
Normen: UNE-EN 13815: 06; UNE-EN 14246: 07.

Rechtwinkligkeit

Alle Komponenten werden individuell geprüft, um in 500mm ab Ecke Herstellungsfehler, zu vermeiden, die größer sind als 0,5mm.

Ebenheit

Alle Komponenten werden individuell geprüft, um auf 1 m Herstellungsfehler zu vermeiden, die größer sind als 1mm.

Dicke

Alle Komponenten für durchgehende Decken werden individuell geprüft, um Abweichungen über 2mm von der durchschnittlichen Zieldicke zu vermeiden.

Maßtoleranz

Alle Komponenten werden individuell geprüft, um größere Maßabweichen als +/- 3mm zu vermeiden.
Weitere information auf www.soft-architecture.com.

Ausblühung

Alle Komponenten mit beleuchteten/sichtbaren Oberflächen werden individuell geprüft, um Lichtausblühungen zu vermeiden.

Handgefertigt

Dieses Produkt wurde handgefertigt. Mögliche Mängel sind auf die Herstellung per Hand zurückzuführen.

PHYSICAL CHARACTERISTICS

Water Penetration

The material shall be suitable for all internal application, and shall not absorb moisture which may be present through excessive humidity. The material should not be used externally.

Reaction to Fire test for building products

The product Soft Architecture is classified as A1 or A1fl, according to UNE-EN 13501-1: 07, and test methods UNE-EN ISO 1716:02 and UNE-EN ISO 1182:02.

Chemical Resistance

The material shall not be exposed to liquid chemicals or deliquesced crystals.

Thermal Insulation

The material shall have a thermal conductivity value not greater than 0.47W/m. deg K.

Density

The material have a medium density of 1323 Kg/m³.

Structural Characteristics

The material shall have the following characteristics (following EN 13279-2:2006).
Flexion max load: 139N at 7.2mm thickness.
Compression: compression max load shall be bigger than 10000N.
Hardness: Shore C hardness shall be above 90.

FEATURES OF MATERIALS

Water Eco Efficiency

Clean water from drinking network is used in correct proportion to provide optimum workability. Water is cyclically re-used through special filters to prevent ecologic damages to nature before disposal.

Mould Release Agents

Proprietary mould release agents are incorporated or applied externally to the mould surface, to optimize cycle time and to achieve consistency of surface finish. These agents shall not have any adverse effect upon the surface of the produced item.

DESIGN & MANUFACTURING

Design

Latest 3D technology has been applied to develop all components. They are being manufactured and designed in accordance with a fully documented quality assurance system complying with ISO 9001:2008.

QUALITY CONTROL

General

All components are individually inspected to prevent surface or manufacturing defects.
Normative: UNE-EN 13815: 06; UNE-EN 14246: 07.

Squareness

All components are individually inspected to prevent manufacturing defects bigger than 0.5mm to 500mm from corner.

Flatness

All components are individually inspected to prevent flatness manufacturing defects bigger than 1mm in 1m.

Thickness

All components for continuous ceilings are individually inspected to prevent changes bigger than 2mm in mean target thickness.

Dimensional Tolerance

All components are individually inspected to prevent dimensional tolerance above +/- 3mm.
For more info see www.soft-architecture.com.

Eflorescence

All components with illuminated/visible surface are individually inspected to prevent light eflorescence .

Handmade

This product has been manufactured by hand. Any imperfection is because of its handcrafted process.



GEMEINSAME BEDINGUNGEN COMMON TERMS



CRADLE TO CRADLE

Soft Architecture ist auf Langlebigkeit ausgelegt und darauf, schädliche Auswirkungen der Produktion auf die Umwelt zu vermeiden. Unsere wichtigsten Ziele sind Nachhaltigkeit, Innovation und Qualität, von der Natur inspiriert. 1-10V

1-10V

Die 1-10V-Steuereinheit ist eines der ersten und einfachsten elektronischen Geräte zur Beleuchtungssteuerung. Das Kontrollsignal besteht aus Gleichstrom zwischen einem und zehn Volt. Die Leistung der gesteuerten Leuchte muss so aufgeteilt werden, dass sie bei 10 V 100 % ihrer potentiellen Leistung liefert und 0 % Leistung bei 1 V. ("Aus").

CRI

Der Farbwiedergabeindex (CRI) ist eine quantitative Maßeinheit für die Fähigkeit einer Lichtquelle, die Farben verschiedener Objekte im Vergleich zu idealer oder natürlicher Beleuchtung wahrheitsgetreu wiederzugeben. Lichtquellen mit einem hohen CRI sind insbesondere für Verwendungszwecke erwünscht, bei denen Farben eine entscheidende Rolle spielen.

DALI

Das Digital Addressable Lighting Interface (DALI) ist ein technischer Standard für netzwerkbasierende Systeme, die die Beleuchtung in Gebäuden steuern. Das Standard-DALI umfasst das Kommunikationsprotokoll und das elektrische Interface für Netzwerke zur Beleuchtungssteuerung.

DIMMER

Dimmer sind Geräte, die zur Anpassung der Helligkeit einer Lichtquelle verwendet werden.

DMX

DMX ist ein Standard für digitale Kommunikationsnetzwerke, die in der Regel für die Steuerung von Bühnenbeleuchtung verwendet werden. Ermöglicht die Programmierung der Farbregulierung und der Variation für RGB.

KELVIN

Kelvin ist die Bezeichnung der Maßeinheit für die Kontrolle der Temperatur von Lichtquellen. Die Farbtemperatur ist eine Eigenschaft von sichtbarem Licht, die eine wesentliche Rolle bei der Beleuchtung spielt, da sie angibt, ob das Licht warm ist (niedrige Farbtemperatur) oder kalt (niedrige Farbtemperatur).

LUMEN

Das Lumen (Symbol: lm) ist die SI-Einheit eines Lichtstroms, die Maßeinheit für die Lichtkraft, die vom menschlichen Auge wahrgenommen wird.

MASTER INTERFACE

Ein Master-Interface ist ein elektronisches Gerät, das ein Signal (DALI/DMX/...) empfängt und ein moduliertes Signal für LEDs ausgibt. Es kann das Licht mit maximaler Last steuern.

POWER SUPPLY

Hierbei handelt es sich um ein Gerät, das einen oder mehrere "Stromverbraucher" mit Strom beliefert.

RGB

Das RGB-Farbmodell ist ein additiver Farbraum, in dem rotes, grünes und blaues Licht unterschiedlich gemischt wird, um zahlreiche Farben nachzubilden. Der Name des Modells ist auf die Initialen der drei additiven Grundfarben rot, grün und blau zurückzuführen.

SLAVE INTERFACE

Ein Slave-Interface wird verwendet, um das modulierte Signal des Master-Interface zu erwidern, wenn das Master-Interface einer Installation überlastet ist.

CRADLE TO CRADLE

Soft Architecture is designed to last and to minimize the harmful effects on the natural environment during production. sustainability, innovation and quality are our main goals, inspired by nature.

1-10V

1-10 V is one of the earliest and simplest electronic lighting control. The control signal is a DC voltage that varies between one and ten volts. The controlled lighting should scale its output so that at 10 V, the controlled light should be at 100% of its potential output, and at 1 V it should be at 0% output (i.e. "Off").

CRI

The color rendering index (CRI) is a quantitative measure of the ability of a light source to reproduce the colors of various objects faithfully in comparison with an ideal or natural light source. Light sources with a high CRI are desirable in color-critical applications.

DALI

Digital Addressable Lighting Interface (DALI) is a technical standard for network-based systems that control lighting in buildings. The DALI standard encompasses the communications protocol and electrical interface for lighting control networks.

DIMMER

Dimmers are devices used to vary the brightness of a light.

DMX

DMX is a standard for digital communication networks that are commonly used to control stage lighting. Allows to program the colour regulation and variation for RGB.

KELVIN

The kelvin is used in the measure of the color temperature of light sources. Color temperature is a characteristic of visible light that has important applications in lighting because it indicates if the light is warm (low color temperatures) or cold (high color temperatures).

LUMEN

The lumen (symbol: lm) is the SI unit of luminous flux, a measure of the power of light perceived by the human eye.

MASTER INTERFACE

The master interface is an electronic device which receives the signal (DALI/DMX/...) and returns a modulated signal for the LED. It's able to control the light with a maximum power load.

POWER SUPPLY

A power supply is a device that supplies electrical energy to one or more electric loads.

RGB

The RGB color model is an additive color model in which red, green, and blue light are added together in various ways to reproduce a broad array of colors. The name of the model comes from the initials of the three additive primary colors, red, green, and blue.

SLAVE INTERFACE

The slave interface is used to reply the modulated signal of the master interface in installations where the master is overloaded.

Hinweis: Die technischen Daten können ohne Vorankündigung geändert werden. Die Informationen entsprechen unseren derzeitigen Produktionsbedingungen und spiegeln die typischen Werte für die Parameter der Herstellungsspezifikation sowie die typischen Endnutzungszwecke wider. Wir übernehmen keinerlei Haftung oder Verantwortung für Schäden, die aus einer unangemessenen Verwendung zu nicht vorgesehenen Endnutzungszwecken resultieren.

Note: Technical data are subject to changes without any previous notice. Information is consistent with our current production conditions and reflects typical values relating to manufacturing specification parameters and for typical end uses. We accept no liability or responsibility for any damage caused by products incorrectly applied in non typical end uses.

QUICK SEARCH OF PRODUCT

Ref.	Page	Ref.	Page	Ref.	Page	Ref.	Page	Ref.	Page	Ref.	Page
03.0700.14A	458	03.0723.TKA	461	03.0805.14	464	03.1232.ERA	553	03.1256.ERA	552	03.2237.40A	80
03.0700.14ANT	458	03.0730.14A	462	03.0805.40	464	03.1232.ESA	553	03.1256.ESA	552	03.2238.14A	80
03.0700.40A	458	03.0730.40A	462	03.1060.14	574	03.1233.DRA	553	03.1257.DRA	552	03.2238.40A	80
03.0700.40ANT	458	03.0730.CEA	462	03.1060.29	574	03.1233.DYA	553	03.1257.DYA	552	03.2240.14	81
03.0701.14A	458	03.0730.TKA	462	03.1060.30	574	03.1233.TKA	553	03.1257.EQA	552	03.2240.40	81
03.0701.14ANT	458	03.0731.14A	462	03.1060.TK	574	03.1233.ERA	553	03.1257.ERA	552	03.2241.14	81
03.0701.40A	458	03.0731.40A	462	03.1060.WG	574	03.1233.ESA	553	03.1257.ESA	552	03.2241.40	81
03.0701.40ANT	458	03.0731.CEA	462	03.1061.14	575	03.1235.DRA	553	03.1258.DRA	552	03.2242.14	81
03.0702.14A	459	03.0731.TKA	462	03.1061.29	575	03.1235.DYA	553	03.1258.DYA	552	03.2242.40	81
03.0702.14ANT	459	03.0732.14A	462	03.1061.30	575	03.1235.EQA	553	03.1258.EQA	552	03.2243.14	81
03.0702.40A	459	03.0732.40A	462	03.1061.TK	575	03.1235.ERA	553	03.1258.ERA	552	03.2243.40	81
03.0702.40ANT	459	03.0732.CEA	462	03.1061.WG	575	03.1235.ESA	553	03.1258.ESA	552	03.2245.14	81
03.0703.14A	459	03.0732.TKA	462	03.1063.14	575	03.1236.DRA	553	03.2001.01	403	03.2245.40	81
03.0703.14ANT	459	03.0733.14A	462	03.1063.29	575	03.1236.DYA	553	03.2001.01.DA	403	03.2246.14	81
03.0703.40A	459	03.0733.40A	462	03.1063.30	575	03.1236.EQA	553	03.2001.14	403	03.2246.40	81
03.0703.40ANT	459	03.0733.CEA	462	03.1063.TK	575	03.1236.ERA	553	03.2001.14.DA	403	03.2247.14	81
03.0704.14A	458	03.0733.TKA	462	03.1063.WG	575	03.1236.ESA	553	03.2001.CU	403	03.2247.40	81
03.0704.14ANT	458	03.0734.14A	462	03.1064.14	575	03.1237.DRA	553	03.2001.CU.DA	403	03.2248.14	81
03.0704.40A	458	03.0734.40A	462	03.1064.29	575	03.1237.DYA	553	03.2003.01	403	03.2248.40	81
03.0704.40ANT	458	03.0734.CEA	462	03.1064.30	575	03.1237.EQA	553	03.2003.01.DA	403	03.2250.14	81
03.0705.14A	458	03.0734.TKA	462	03.1064.TK	575	03.1237.ERA	553	03.2003.14	403	03.2250.40	81
03.0705.14ANT	458	03.0735.14A	462	03.1064.WG	575	03.1237.ESA	553	03.2003.14.DA	403	03.2251.14	81
03.0705.40A	458	03.0735.40A	462	03.1200.DR	550	03.1238.DRA	553	03.2003.CU	403	03.2251.40	81
03.0705.40ANT	458	03.0735.CEA	462	03.1200.DY	550	03.1238.DYA	553	03.2003.CU.DA	403	03.2252.14	81
03.0706.14A	459	03.0735.TKA	462	03.1200.EQ	550	03.1238.EQA	553	03.2005.01	404	03.2252.40	81
03.0706.14ANT	459	03.0740.14	464	03.1200.ER	550	03.1238.ERA	553	03.2005.01.DA	404	03.2253.14	81
03.0706.40A	459	03.0740.40	464	03.1200.ES	550	03.1238.ESA	553	03.2005.14	404	03.2253.40	81
03.0706.40ANT	459	03.0741.14	464	03.1201.DR	550	03.1240.DRA	554	03.2005.14.DA	404	03.2255.14	81
03.0707.14A	459	03.0741.40	464	03.1201.DY	550	03.1240.DYA	554	03.2005.CU	404	03.2255.40	81
03.0707.14ANT	459	03.0742.14	464	03.1201.EQ	550	03.1240.EQA	554	03.2005.CU.DA	404	03.2256.14	81
03.0707.40A	459	03.0742.40	464	03.1201.ER	550	03.1240.ERA	554	03.2006.01	403	03.2256.40	81
03.0707.40ANT	459	03.0743.14	464	03.1201.ES	550	03.1240.ESA	554	03.2006.01.DA	403	03.2257.14	81
03.0708.14A	458	03.0743.40	464	03.1205.DR	550	03.1241.DRA	554	03.2006.14	403	03.2257.40	81
03.0708.14ANT	458	03.0744.14	464	03.1205.DY	550	03.1241.DYA	554	03.2006.14.DA	403	03.2258.14	81
03.0708.40A	458	03.0744.40	464	03.1205.EQ	550	03.1241.EQA	554	03.2006.CU	403	03.2258.40	81
03.0708.40ANT	458	03.0745.14	464	03.1205.ER	550	03.1241.ERA	554	03.2006.CU.DA	403	03.2260.14	76
03.0709.14A	458	03.0745.40	464	03.1205.ES	550	03.1241.ESA	554	03.2007.01	403	03.2261.14	76
03.0709.14ANT	458	03.0760.14A	461	03.1206.DR	550	03.1242.DRA	554	03.2007.01.DA	403	03.2262.14	76
03.0709.40A	458	03.0760.40A	461	03.1206.DY	550	03.1242.DYA	554	03.2007.14	403	03.2263.14	76
03.0709.40ANT	458	03.0760.CEA	461	03.1206.EQ	550	03.1242.EQA	554	03.2007.14.DA	403	03.2264.14	76
03.0710.14A	459	03.0760.TKA	461	03.1206.ER	550	03.1242.ERA	554	03.2007.CU	403	03.2265.14	76
03.0710.14ANT	459	03.0761.14A	461	03.1206.ES	550	03.1242.ESA	554	03.2007.CU.DA	403	03.2266.14	76
03.0710.40A	459	03.0761.40A	461	03.1210.DR	551	03.1243.DRA	554	03.2008.01	404	03.2267.14	76
03.0710.40ANT	459	03.0761.CEA	461	03.1210.DY	551	03.1243.DYA	554	03.2008.01.DA	404	03.2268.14	76
03.0711.14A	459	03.0761.14A	461	03.1210.EQ	551	03.1243.EQA	554	03.2008.14	404	03.2269.14	76
03.0711.14ANT	459	03.0762.14A	461	03.1210.ER	551	03.1243.ERA	554	03.2008.14.DA	404	03.2270.14	76
03.0711.40A	459	03.0762.40A	461	03.1210.ES	551	03.1243.ESA	554	03.2008.CU	404	03.2271.14	76
03.0711.40ANT	459	03.0762.CEA	461	03.1211.DR	551	03.1245.DRA	554	03.2008.CU.DA	404	03.2272.14	76
03.0712.14A	460	03.0762.TKA	461	03.1211.DY	551	03.1245.DYA	554	03.2152.40ACB	261	03.2273.14	76
03.0712.14ANT	460	03.0763.14A	461	03.1211.EQ	551	03.1245.EQA	554	03.2152.40ADA	261	03.2274.14	76
03.0712.40A	460	03.0763.40A	461	03.1211.ER	551	03.1245.ERA	554	03.2210.14A	78	03.2275.14	76
03.0712.40ANT	460	03.0763.CEA	461	03.1211.ES	551	03.1245.ESA	554	03.2210.40A	78	03.2280.14	77
03.0713.14A	460	03.0763.TKA	461	03.1215.DR	551	03.1246.DRA	554	03.2211.14A	78	03.2281.14	77
03.0713.14ANT	460	03.0764.14A	461	03.1215.DY	551	03.1246.DYA	554	03.2211.40A	78	03.2282.14	77
03.0713.40A	460	03.0764.40A	461	03.1215.EQ	551	03.1246.EQA	554	03.2212.14A	78	03.2283.14	77
03.0713.40ANT	460	03.0764.CEA	461	03.1215.ER	551	03.1246.ERA	554	03.2212.40A	78	03.2284.14	77
03.0714.14A	460	03.0764.TKA	461	03.1215.ES	551	03.1246.ESA	554	03.2213.14A	78	03.2285.14	77
03.0714.14ANT	460	03.0765.14A	461	03.1216.DR	551	03.1247.DRA	554	03.2213.40A	78	03.2286.14	77
03.0714.40A	460	03.0765.40A	461	03.1216.DY	551	03.1247.DYA	554	03.2215.14A	78	03.2287.14	77
03.0714.40ANT	460	03.0765.CEA	461	03.1216.EQ	551	03.1247.EQA	554	03.2215.40A	78	03.2288.14	77
03.0715.14A	460	03.0765.TKA	461	03.1216.ER	551	03.1247.ERA	554	03.2216.14A	78	03.2289.14	77
03.0715.14ANT	460	03.0770.14A	462	03.1216.ES	551	03.1247.ESA	554	03.2216.40A	78	03.2290.14	77
03.0715.40A	460	03.0770.40A	462	03.1220.DR	550	03.1248.DRA	554	03.2217.14A	78	03.2291.14	77
03.0715.40ANT	460	03.0770.CEA	462	03.1220.DY	550	03.1248.DYA	554	03.2217.40A	78	03.2292.14	77
03.0716.14A	460	03.0770.TKA	462	03.1220.EQ	550	03.1248.EQA	554	03.2218.14A	78	03.2293.14	77
03.0716.14ANT	460	03.0771.14A	462	03.1220.ER	550	03.1248.ERA	554	03.2218.40A	78	03.2294.14	77
03.0716.40A	460	03.0771.40A	462	03.1220.ES	550	03.1248.ESA	554	03.2220.14A	79	03.2295.14	77
03.0716.40ANT	460	03.0771.CEA	462	03.1221.DR	550	03.1250.DRA	552	03.2220.40A	79	03.2300.14A	79
03.0717.14A	460	03.0771.TKA	462	03.1221.DY	550	03.1250.DYA	552	03.2221.14A	79	03.2300.40A	79
03.0717.14ANT	460	03.0772.14A	462	03.1221.EQ	550	03.1250.EQA	552	03.2221.40A	79	03.2301.14A	79
03.0717.40A	460	03.0772.40A	462	03.1221.ER	550	03.1250.ERA	552	03.2222.14A	79	03.2301.40A	79
03.0717.40ANT	460	03.0772.CEA	462	03.1221.ES	550	03.1250.ESA	552	03.2222.40A	79	03.2302.14A	79
03.0718.14A	461	03.0772.TKA	462	03.1225.DR	550	03.1251.DRA	552	03.2223.14A	79	03.2302.40A	79
03.0718.40A	461	03.0773.14A	462	03.1225.DY	550	03.1251.DYA	552	03.2223.40A	79	03.2303.14A	79
03.0718.CEA	461	03.0773.40A	462	03.1225.EQ	550	03.1251.EQA	552	03.2225.14A	79	03.2303.40A	79
03.0718.TKA	461	03.0773.CEA	462	03.1225.ER	550	03.1251.ERA	552	03.2225.40A	79	03.2520.14	470
03.0719.14A	461	03.0773.TKA	462	03.1225.ES	550	03.1251.ESA	552	03.2226.14A	79	03.2520.30	470
03.0719.40A	461	03.0774.14A	462	03.1226.DR	550	03.1252.DRA	552	03.2226.40A	79	03.2521.14	470
03.0719.CEA	461	03.0774.40A	462	03.1226.DY	550	03.1252.DYA	552	03.2227.14A	79	03.2521.30	470
03.0719.TKA	461	03.0774.CEA	462	03.1226.EQ	550	03.1252.EQA	552	03.2227.40A	79	03.2600.14	574
03.0720.14A	461	03.0774.TKA	462	03.1226.ER	550	03.1252.ERA	552	03.2228.14A	79	03.2600.29	574
03.0720.40A	461	03.0775.14A	462	03.1226.ES	550	03.1252.ESA	552	03.2228.40A	79	03.2600.30	574
03.0720.CEA	461	03.0775.40A	462	03.1230.DRA	553	03.1253.DRA	552	03.2230.14A	80	03.2600.TK	574
03.0720.TKA	461	03.0775.CEA	462	03.1230.DYA	553	03.1253.DYA	552	03.2230.40A	80	03.2600.WG	574
03.0721.14A	461	03.0775.TKA	462	03.1230.EQA	553	03.1253.EQA	552	03.2231.14A	80	03.2601.14	574
03.0721.40A	461	03.0800.14	464	03.1230.ERA	553	03.1253.ERA	552	03.2231.40A	80	03.2601.29	574
03.0721.CEA	461	03.0800.40	464								

QUICK SEARCH OF PRODUCT

Ref.	Page	Ref.	Page	Ref.	Page	Ref.	Page	Ref.	Page	Ref.	Page
03.2630.29A	572	03.3538.30	448	03.4172.B1.LE	377	03.4187.CU	322	03.4200.B1.LE	381	03.4236.CU	326
03.2630.30A	572	03.3539.02	448	03.4172.BU	376	03.4187.GL	322	03.4200.BU	380	03.4236.GL	326
03.2630.TKA	572	03.3539.14	448	03.4172.BU.LE	377	03.4188.74	327	03.4200.BU.LE	381	03.4237.74	326
03.2630.WGA	572	03.3539.30	448	03.4172.CU	376	03.4188.74.LE	328	03.4200.CU	380	03.4237.B1	326
03.2631.14A	572	03.3902.30C	288	03.4172.CU.LE	377	03.4188.B1	327	03.4200.CU.LE	381	03.4237.BU	326
03.2631.29A	572	03.3903.30C	288	03.4172.GL	376	03.4188.B1.LE	328	03.4200.GL	380	03.4237.CU	326
03.2631.30A	572	03.3904.30C	288	03.4172.GL.LE	377	03.4188.BU	327	03.4200.GL.LE	381	03.4237.GL	326
03.2631.TKA	572	03.3922.30C	288	03.4176.74	365	03.4188.BU.LE	328	03.4201.74	380	03.4242.74	331
03.2631.WGA	572	03.3923.30C	288	03.4176.74.LE	366	03.4188.CU	327	03.4201.B1	380	03.4242.B1	331
03.2632.14A	572	03.3924.30C	288	03.4176.B1	365	03.4188.CU.LE	328	03.4201.BU	380	03.4242.BU	331
03.2632.29A	572	03.3960.29B	166	03.4176.B1.LE	366	03.4188.GL	327	03.4201.CU	380	03.4242.CU	331
03.2632.30A	572	03.3960.ANB	166	03.4176.BU	365	03.4188.GL.LE	328	03.4201.GL	380	03.4242.GL	331
03.2632.TKA	572	03.3962.29B	166	03.4176.BU.LE	366	03.4189.74	327	03.4208.74	371	03.4243.74	331
03.2632.WGA	572	03.3962.ANB	166	03.4176.CU	365	03.4189.B1	327	03.4208.B1	371	03.4243.B1	331
03.2635.14A	572	03.3963.29B	166	03.4176.CU.LE	366	03.4189.BU	327	03.4208.BU	371	03.4243.BU	331
03.2635.29A	572	03.3963.ANB	166	03.4176.GL	365	03.4189.CU	327	03.4208.CU	371	03.4243.CU	331
03.2635.30A	572	03.3970.02A	167	03.4176.GL.LE	366	03.4189.GL	327	03.4208.GL	371	03.4243.GL	331
03.2635.TKA	572	03.3970.14A	167	03.4177.74	365	03.4190.74	329	03.4209.74	371	03.4244.74	331
03.2635.WGA	572	03.3970.30A	167	03.4177.B1	365	03.4190.74.LE	330	03.4209.B1	371	03.4244.B1	331
03.2636.14A	572	03.3971.02A	167	03.4177.BU	365	03.4190.B1	329	03.4209.BU	371	03.4244.BU	331
03.2636.29A	572	03.3971.14A	167	03.4177.CU	365	03.4190.B1.LE	330	03.4209.CU	371	03.4244.CU	331
03.2636.30A	572	03.3971.30A	167	03.4177.GL	365	03.4190.BU	329	03.4209.GL	371	03.4244.GL	331
03.2636.TKA	572	03.3972.02A	167	03.4178.74	369	03.4190.BU.LE	330	03.4210.74	371	03.4245.74	331
03.2636.WGA	572	03.3972.14A	167	03.4178.74.LE	370	03.4190.CU	329	03.4210.B1	371	03.4245.B1	331
03.2637.14A	572	03.3972.30A	167	03.4178.B1	369	03.4190.CU.LE	330	03.4210.BU	371	03.4245.BU	331
03.2637.29A	572	03.3975.02A	167	03.4178.B1.LE	370	03.4190.GL	329	03.4210.CU	371	03.4245.CU	331
03.2637.30A	572	03.3975.14A	167	03.4178.BU	369	03.4190.GL.LE	330	03.4210.GL	371	03.4245.GL	331
03.2637.TKA	572	03.3975.30A	167	03.4178.BU.LE	370	03.4191.74	329	03.4211.74	371	03.4287.74	359
03.2637.WGA	572	03.3976.02A	167	03.4178.CU	369	03.4191.B1	329	03.4211.B1	371	03.4287.74.LE	360
03.2640.14A	573	03.3976.14A	167	03.4178.CU.LE	370	03.4191.BU	329	03.4211.BU	371	03.4287.B1	359
03.2640.29A	573	03.3976.30A	167	03.4178.GL	369	03.4191.CU	329	03.4211.CU	371	03.4287.B1.LE	360
03.2640.30A	573	03.3977.02A	167	03.4178.GL.LE	370	03.4191.GL	329	03.4211.GL	371	03.4287.BU	359
03.2640.TKA	573	03.3977.14A	167	03.4179.74	369	03.4192.74	361	03.4212.74	384	03.4287.BU.LE	360
03.2640.WGA	573	03.3977.30A	167	03.4179.B1	369	03.4192.74.LE	362	03.4212.B1	384	03.4287.CU	359
03.2641.14A	573	03.4060.29	166	03.4179.BU	369	03.4192.B1	361	03.4212.BU	384	03.4287.CU.LE	360
03.2641.29A	573	03.4060.29.1Y	166	03.4179.CU	369	03.4192.B1.LE	362	03.4212.CU	384	03.4287.GL	359
03.2641.30A	573	03.4061.29	166	03.4179.GL	369	03.4192.BU	361	03.4212.GL	384	03.4287.GL.LE	360
03.2641.TKA	573	03.4061.29.1Y	166	03.4180.74	303	03.4192.BU.LE	362	03.4213.74	384	03.4288.74	359
03.2641.WGA	573	03.4062.29	166	03.4180.74.LE	304	03.4192.CU	361	03.4213.B1	384	03.4288.B1	359
03.2642.14A	573	03.4062.29.1Y	166	03.4180.B1	303	03.4192.CU.LE	362	03.4213.BU	384	03.4288.BU	359
03.2642.29A	573	03.4063.29	166	03.4180.B1.LE	304	03.4192.GL	361	03.4213.CU	384	03.4288.CU	359
03.2642.30A	573	03.4063.29.1Y	166	03.4180.BU	303	03.4192.GL.LE	362	03.4213.GL	384	03.4288.GL	359
03.2642.TKA	573	03.4064.29	166	03.4180.BU.LE	304	03.4193.74	361	03.4218.74	389	03.4293.74	378
03.2642.WGA	573	03.4064.29.1Y	166	03.4180.CU	303	03.4193.B1	361	03.4218.B1	389	03.4293.74.LE	379
03.2645.14A	573	03.4065.14A	166	03.4180.CU.LE	304	03.4195.29	361	03.4218.BU	389	03.4293.B1	378
03.2645.29A	573	03.4065.29.1Y	166	03.4180.GL	303	03.4193.CU	361	03.4218.CU	389	03.4293.B1.LE	379
03.2645.30A	573	03.4065.29.5Y	166	03.4180.GL.LE	304	03.4193.GL	361	03.4218.CU	389	03.4293.BU	378
03.2645.TKA	573	03.4153.74	372	03.4181.74	303	03.4194.74	367	03.4219.74	389	03.4293.BU.LE	379
03.2645.WGA	573	03.4153.B1	372	03.4181.B1	303	03.4194.74.LE	368	03.4219.B1	389	03.4293.CU	378
03.2646.14A	573	03.4153.BU	372	03.4181.BU	303	03.4194.B1	367	03.4219.BU	389	03.4293.CU.LE	379
03.2646.29A	573	03.4153.CU	372	03.4181.CU	303	03.4194.B1.LE	368	03.4219.CU	389	03.4293.GL	378
03.2646.30A	573	03.4153.GL	372	03.4181.GL	303	03.4194.BU	367	03.4219.GL	389	03.4293.GL.LE	379
03.2646.TKA	573	03.4155.74	374	03.4182.74	309	03.4194.BU.LE	368	03.4220.74	389	03.4294.74	378
03.2646.WGA	573	03.4155.B1	374	03.4182.74.LE	310	03.4194.CU	367	03.4220.B1	389	03.4294.B1	378
03.2647.14A	573	03.4155.BU	374	03.4182.B1	309	03.4194.CU.LE	368	03.4220.BU	389	03.4294.BU	378
03.2647.29A	573	03.4155.CU	374	03.4182.B1.LE	310	03.4194.GL	367	03.4220.CU	389	03.4294.CU	378
03.2647.30A	573	03.4155.GL	374	03.4182.BU	309	03.4194.GL.LE	368	03.4220.GL	389	03.4294.GL	378
03.2647.TKA	573	03.4157.74	376	03.4182.BU.LE	310	03.4195.74	367	03.4221.74	389	03.4295.74	382
03.2647.WGA	573	03.4157.B1	376	03.4182.CU	309	03.4195.B1	367	03.4221.B1	389	03.4295.74.LE	383
03.2650.14	470	03.4157.BU	376	03.4182.CU.LE	310	03.4195.BU	367	03.4221.BU	389	03.4295.B1	382
03.2650.30	470	03.4157.CU	376	03.4182.GL	309	03.4195.CU	367	03.4221.CU	389	03.4295.B1.LE	383
03.2651.14	470	03.4157.GL	376	03.4182.GL.LE	310	03.4195.GL	367	03.4221.GL	389	03.4295.BU	382
03.2651.30	470	03.4160.74	384	03.4183.74	309	03.4196.74	385	03.4226.74	313	03.4295.BU.LE	383
03.2675.14A	469	03.4160.B1	384	03.4183.B1	309	03.4196.74.LE	386	03.4226.B1	313	03.4295.CU	382
03.2675.30A	469	03.4160.BU	384	03.4183.BU	309	03.4196.B1	385	03.4226.BU	313	03.4295.CU.LE	383
03.2676.14A	469	03.4160.CU	384	03.4183.CU	309	03.4196.B1.LE	386	03.4226.CU	313	03.4295.GL	382
03.2676.30A	469	03.4160.GL	384	03.4183.GL	309	03.4196.BU	385	03.4226.GL	313	03.4295.GL.LE	383
03.2677.14A	469	03.4162.74	384	03.4184.74	316	03.4196.BU.LE	386	03.4227.74	313	03.4296.74	382
03.2677.30A	469	03.4162.B1	384	03.4184.74.LE	317	03.4196.CU	385	03.4227.B1	313	03.4296.B1	382
03.2680.14A	469	03.4162.BU	384	03.4184.B1	316	03.4196.CU.LE	386	03.4227.BU	313	03.4296.BU	382
03.2680.30A	469	03.4162.CU	384	03.4184.B1.LE	317	03.4196.GL	385	03.4227.CU	313	03.4296.CU	382
03.2681.14A	469	03.4162.GL	384	03.4184.BU	316	03.4196.GL.LE	386	03.4227.GL	313	03.4296.GL	382
03.2681.30A	469	03.4170.74	372	03.4184.BU.LE	317	03.4197.74	385	03.4228.74	313	03.4297.74	363
03.2682.14A	469	03.4170.74.LE	373	03.4184.CU	316	03.4197.B1	385	03.4228.B1	313	03.4297.74.LE	364
03.2682.30A	469	03.4170.B1	372	03.4184.CU.LE	317	03.4197.BU	385	03.4228.BU	313	03.4297.B1	363
03.3502.02	450	03.4170.B1.LE	373	03.4184.GL	316	03.4197.CU	385	03.4228.CU	313	03.4297.B1.LE	364
03.3502.14	450	03.4170.BU	372	03.4184.GL.LE	317	03.4197.GL	385	03.4228.GL	313	03.4297.BU	363
03.3502.30	450	03.4170.BU.LE	373	03.4185.74	316	03.4198.74	387	03.4229.74	313	03.4297.BU.LE	364
03.3505.02	449	03.4170.CU	372	03.4185.B1	316	03.4198.74.LE	388	03.4229.B1	313	03.4297.CU	363
03.3505.14	449	03.4170.CU.LE	373	03.4185.BU	316	03.4198.B1	387	03.4229.BU	313	03.4297.CU.LE	364
03.3505.30	449	03.4170.GL	372	03.4185.CU	316	03.4198.B1.LE	388	03.4229.CU	313	03.4297.GL	363
03.3506.02	448	03.4170.GL.LE	373	03.4185.GL	316	03.4198.BU	387	03.4229.GL	313	03.4297.GL.LE	364
03.3506.14	448	03.4171.74	374	03.4186.74	322	03.4198.BU.LE	388	03.4234.74	326	03.4298.74	363
03.3506.30	448	03.4171.74.LE	375	03.4186.74.LE	323	03.4198.CU	387	03.4234.B1	326	03.4298.B1	363
03.3507.02	449	03.4171.B1	374	03.4186.B1	322	03.4198.CU.LE	388	03.4234.BU	326	03.4298.BU	363
03.3507.14	449	03.4171.B1.LE	375	03.4186.B1.LE	323	03.4198.GL	387	03.4234.CU	326	03.4298.CU	363
03.3507.30	449	03.4171.BU	374	03.4186.BU	322	03.4198.GL.LE	388	03.4234.GL	326	03.4298.GL	363

QUICK SEARCH OF PRODUCT

Ref.	Page	Ref.	Page	Ref.	Page	Ref.	Page	Ref.	Page	Ref.	Page
03.4420.BUCDA	347	03.4523.ANB	568	03.4542.B1	320	03.4585.74.DA	348	03.4981.06.DA	416	03.4999.GL	417
03.4420.CUC	347	03.4523.ASB	568	03.4542.B1.LE	321	03.4585.B1	348	03.4981.14	416	03.4999.GL.DA	417
03.4420.CUC1V	347	03.4523.B3B	568	03.4542.BU	320	03.4585.B1.1V	348	03.4981.14.DA	416	03.5730.11B	568
03.4420.CUCDA	347	03.4530.74	301	03.4542.BU.LE	321	03.4585.B1.DA	348	03.4981.GL	416	03.5730.ANB	568
03.4420.GLC	347	03.4530.74.LE	302	03.4542.CU	320	03.4585.BU	348	03.4981.GL.DA	416	03.5730.ASB	568
03.4420.GLC1V	347	03.4530.B1	301	03.4542.CU.LE	321	03.4585.BU.1V	348	03.4982.06A	416	03.5730.B3B	568
03.4420.GLCDA	347	03.4530.B1.LE	302	03.4542.GL	320	03.4585.BU.DA	348	03.4982.06ADA	416	03.5731.11B	568
03.4475.74C	351	03.4530.BU	301	03.4542.GL.LE	321	03.4585.CU	348	03.4982.14A	416	03.5731.ANB	568
03.4475.74C1V	351	03.4530.BU.LE	302	03.4543.74	320	03.4585.CU.1V	348	03.4982.14ADA	416	03.5731.ASB	568
03.4475.74CDA	351	03.4530.CU	301	03.4543.B1	320	03.4585.CU.DA	348	03.4982.GLA	416	03.5731.B3B	568
03.4475.B1C	351	03.4530.CU.LE	302	03.4543.BU	320	03.4585.GL	348	03.4982.GLADA	416	03.5732.11B	568
03.4475.B1C1V	351	03.4530.GL	301	03.4543.CU	320	03.4585.GL.1V	348	03.4983.06	416	03.5732.ANB	568
03.4475.B1CDA	351	03.4530.GL.LE	302	03.4543.GL	320	03.4585.GL.DA	348	03.4983.06.DA	416	03.5732.ASB	568
03.4475.BUC	351	03.4531.74	301	03.4544.74	324	03.4586.74	350	03.4983.14	416	03.5732.B3B	568
03.4475.BUC1V	351	03.4531.B1	301	03.4544.74.LE	325	03.4586.74.1V	350	03.4983.14.DA	416	03.5733.11B	568
03.4475.BUCDA	351	03.4531.BU	301	03.4544.B1	324	03.4586.74.DA	350	03.4983.GL	416	03.5733.ANB	568
03.4475.CUC	351	03.4531.CU	301	03.4544.B1.LE	325	03.4586.B1	350	03.4983.GL.DA	416	03.5733.ASB	568
03.4475.CUC1V	351	03.4531.GL	301	03.4544.BU	324	03.4586.B1.1V	350	03.4984.06A	417	03.5733.B3B	568
03.4475.CUCDA	351	03.4532.74	305	03.4544.BU.LE	325	03.4586.B1.DA	350	03.4984.06ADA	417	03.5810.11B	569
03.4475.GLC	351	03.4532.74.LE	306	03.4544.CU	324	03.4586.BU	350	03.4984.14A	417	03.5810.ANB	569
03.4475.GLC1V	351	03.4532.B1	305	03.4544.CU.LE	325	03.4586.BU.1V	350	03.4984.14ADA	417	03.5810.ASB	569
03.4475.GLCDA	351	03.4532.B1.LE	306	03.4544.GL	324	03.4586.BU.DA	350	03.4984.GLA	417	03.5810.B3B	569
03.4482.74C	349	03.4532.BU	305	03.4544.GL.LE	325	03.4586.CU	350	03.4984.GLADA	417	03.5811.11B	569
03.4482.74C1V	349	03.4532.BU.LE	306	03.4545.74	324	03.4586.CU.1V	350	03.4985.06	417	03.5811.ANB	569
03.4482.74CDA	349	03.4532.CU	305	03.4545.B1	324	03.4586.CU.DA	350	03.4985.06.DA	417	03.5811.ASB	569
03.4482.B1C	349	03.4532.CU.LE	306	03.4545.BU	324	03.4586.GL	350	03.4985.14	417	03.5811.B3B	569
03.4482.B1C1V	349	03.4532.GL	305	03.4545.CU	324	03.4586.GL.1V	350	03.4985.14.DA	417	03.5812.11B	569
03.4482.B1CDA	349	03.4532.GL.LE	306	03.4545.GL	324	03.4586.GL.DA	350	03.4985.GL	417	03.5812.ANB	569
03.4482.BUC	349	03.4533.74	305	03.4570.74C	332	03.4587.74	350	03.4985.GL.DA	417	03.5812.ASB	569
03.4482.BUC1V	349	03.4533.B1	305	03.4570.74C1V	332	03.4587.74.1V	350	03.4986.06A	417	03.5812.B3B	569
03.4482.BUCDA	349	03.4533.BU	305	03.4570.74CDA	332	03.4587.74.DA	350	03.4986.06ADA	417	03.5813.11B	569
03.4482.CUC	349	03.4533.CU	305	03.4570.B1C	332	03.4587.B1	350	03.4986.14A	417	03.5813.ANB	569
03.4482.CUC1V	349	03.4533.GL	305	03.4570.B1C1V	332	03.4587.B1.1V	350	03.4986.14ADA	417	03.5813.ASB	569
03.4482.CUCDA	349	03.4534.74	307	03.4570.B1CDA	332	03.4587.B1.DA	350	03.4986.GLA	417	03.5813.B3B	569
03.4482.GLC	349	03.4534.74.LE	308	03.4570.BUC	332	03.4587.BU	350	03.4986.GLADA	417	03.5900.14	563
03.4482.GLC1V	349	03.4534.B1	307	03.4570.BUC1V	332	03.4587.BU.1V	350	03.4987.06	417	03.5900.18	563
03.4482.GLCDA	349	03.4534.B1.LE	308	03.4570.BUCDA	332	03.4587.BU.DA	350	03.4987.06.DA	417	03.5900.B1	563
03.4496.74B	347	03.4534.BU	307	03.4570.CUC	332	03.4587.CU	350	03.4987.14	417	03.5901.14	563
03.4496.74B1V	347	03.4534.BU.LE	308	03.4570.CUC1V	332	03.4587.CU.1V	350	03.4987.14.DA	417	03.5901.18	563
03.4496.74BDA	347	03.4534.CU	307	03.4570.CUCDA	332	03.4587.CU.DA	350	03.4987.GL	417	03.5901.B1	563
03.4496.B1B	347	03.4534.CU.LE	308	03.4570.GLC	332	03.4587.GL	350	03.4987.GL.DA	417	03.5902.14	563
03.4496.B1B1V	347	03.4534.GL	307	03.4570.GLC1V	332	03.4587.GL.1V	350	03.4988.06A	418	03.5902.18	563
03.4496.B1BDA	347	03.4534.GL.LE	308	03.4570.GLCDA	332	03.4587.GL.DA	350	03.4988.06ADA	418	03.5902.B1	563
03.4496.BUB	347	03.4535.74	307	03.4572.74	337	03.4588.74	352	03.4989.06	418	03.5903.14	563
03.4496.BUB1V	347	03.4535.B1	307	03.4572.B1	337	03.4588.74.1V	352	03.4989.06.DA	418	03.5903.18	563
03.4496.BUBDA	347	03.4535.BU	307	03.4572.BU	337	03.4588.74.DA	352	03.4990.06A	418	03.5903.B1	563
03.4496.CUB	347	03.4535.CU	307	03.4572.CU	337	03.4588.B1	352	03.4990.06ADA	418	03.5904.14	563
03.4496.CUB1V	347	03.4535.GL	307	03.4572.GL	337	03.4588.B1.1V	352	03.4991.06	418	03.5904.18	563
03.4496.CUBDA	347	03.4536.74	311	03.4582.74	336	03.4588.B1.DA	352	03.4991.06.DA	418	03.5904.B1	563
03.4496.GLB	347	03.4536.74.LE	312	03.4582.74.1V	336	03.4588.BU	352	03.4992.06A	416	03.5905.14	563
03.4496.GLB1V	347	03.4536.B1	311	03.4582.74.DA	336	03.4588.BU.1V	352	03.4992.06ADA	416	03.5905.18	563
03.4496.GLBDA	347	03.4536.B1.LE	312	03.4582.B1	336	03.4588.BU.DA	352	03.4992.14A	416	03.5905.B1	563
03.4497.74B	349	03.4536.BU	311	03.4582.B1.1V	336	03.4588.CU	352	03.4992.14ADA	416	03.5906.14	563
03.4497.74B1V	349	03.4536.BU.LE	312	03.4582.B1.DA	336	03.4588.CU.1V	352	03.4992.GLA	416	03.5906.18	563
03.4497.74BDA	349	03.4536.CU	311	03.4582.BU	336	03.4588.CU.DA	352	03.4992.GLADA	416	03.5906.B1	563
03.4497.B1B	349	03.4536.CU.LE	312	03.4582.BU.1V	336	03.4588.GL	352	03.4993.06	416	03.5907.14	563
03.4497.B1B1V	349	03.4536.GL	311	03.4582.BU.DA	336	03.4588.GL.1V	352	03.4993.06.DA	416	03.5907.18	563
03.4497.B1BDA	349	03.4536.GL.LE	312	03.4582.CU	336	03.4588.GL.DA	352	03.4993.14	416	03.5907.B1	563
03.4497.BUB	349	03.4537.74	311	03.4582.CU.1V	336	03.4589.74	352	03.4993.14.DA	416	03.5910.14	566
03.4497.BUB1V	349	03.4537.B1	311	03.4582.CU.DA	336	03.4589.74.1V	352	03.4993.GL	416	03.5910.18	566
03.4497.BUBDA	349	03.4537.BU	311	03.4582.GL	336	03.4589.74.DA	352	03.4993.GL.DA	416	03.5910.B1	566
03.4497.CUB	349	03.4537.CU	311	03.4582.GL.1V	336	03.4589.B1	352	03.4994.06A	416	03.5911.14	566
03.4497.CUB1V	349	03.4537.GL	311	03.4582.GL.DA	336	03.4589.B1.1V	352	03.4994.06ADA	416	03.5911.18	566
03.4497.CUBDA	349	03.4538.74	314	03.4583.74	336	03.4589.B1.DA	352	03.4994.14A	416	03.5911.B1	566
03.4497.GLB	349	03.4538.74.LE	315	03.4583.74.1V	336	03.4589.BU	352	03.4994.14ADA	416	03.5912.14	566
03.4497.GLB1V	349	03.4538.B1	314	03.4583.74.DA	336	03.4589.BU.1V	352	03.4994.GLA	416	03.5912.18	566
03.4497.GLBDA	349	03.4538.B1.LE	315	03.4583.B1	336	03.4589.BU.DA	352	03.4994.GLADA	416	03.5912.B1	566
03.4498.74B	351	03.4538.BU	314	03.4583.B1.1V	336	03.4589.CU	352	03.4995.06	416	03.5913.14	566
03.4498.74B1V	351	03.4538.BU.LE	315	03.4583.B1.DA	336	03.4589.CU.1V	352	03.4995.06.DA	416	03.5913.18	566
03.4498.74BDA	351	03.4538.CU	314	03.4583.BU	336	03.4589.CU.DA	352	03.4995.14	416	03.5913.B1	566
03.4498.B1B	351	03.4538.CU.LE	315	03.4583.BU.1V	336	03.4589.GL	352	03.4995.14.DA	416	03.5914.14	566
03.4498.B1B1V	351	03.4538.GL	314	03.4583.BU.DA	336	03.4589.GL.1V	352	03.4995.GL	416	03.5914.18	566
03.4498.B1BDA	351	03.4538.GL.LE	315	03.4583.CU	336	03.4589.GL.DA	352	03.4995.GL.DA	416	03.5914.B1	566
03.4498.BUB	351	03.4539.74	314	03.4583.CU.1V	336	03.4595.74C	332	03.4996.06A	417	03.5915.14	566
03.4498.BUB1V	351	03.4539.B1	314	03.4583.CU.DA	336	03.4595.74C1V	332	03.4996.06ADA	417	03.5915.18	566
03.4498.BUBDA	351	03.4539.BU	314	03.4583.GL	336	03.4595.74CDA	332	03.4996.14A	417	03.5915.B1	566
03.4498.CUB	351	03.4539.CU	314	03.4583.GL.1V	336	03.4595.B1C	332	03.4996.14ADA	417	03.5916.14	566
03.4498.CUB1V	351	03.4539.GL	314	03.4583.GL.DA	336	03.4595.B1C1V	332	03.4996.GLA	417	03.5916.18	566
03.4498.CUBDA	351	03.4540.74	318	03.4584.74	348	03.4595.B1CDA	332	03.4996.GLADA	417	03.5916.B1	566
03.4498.GLB	351	03.4540.74.LE	319	03.4584.74.1V	348	03.4595.BUC	332	03.4997.06	417	03.5917.14	566
03.4498.GLB1V	351	03.4540.B1	318	03.4584.74.DA	348	03.4595.BUC1V	332	03.4997.06.DA	417	03.5917.18	566
03.4498.GLBDA	351	03.4540.B1.LE	319	03.4584.B1	348	03.4595.BUCDA	332	03.4997.14	417	03.5917.B1	566
03.4520.11B	568	03.4540.BU	318	03.4584.B1.1V	348	03.4595.CUC	332	03.4997.14.DA	417	03.5920.14	562
03.4520.ANB	568	03.4540.BU.LE	319	03.4584.B1.DA	348	03.4595.CUC1V	332	03.4997.GL	417	03.5920.18	562
03.4520.ASB	568	03.4540.CU	318	03.4584.BU	348	03.4595.CUCDA	332	03.4997.GL.DA	417	03.	

QUICK SEARCH OF PRODUCT

Ref.	Page	Ref.	Page	Ref.	Page	Ref.	Page	Ref.	Page	Ref.	Page
03.5924.18	562	03.6002.14	563	03.6021.B1.DA	562	03.6041.B1	564	03.6170.14	541	03.6298.14.CB	104
03.5924.B1	562	03.6002.14.DA	563	03.6022.14	562	03.6041.B1.DA	564	03.6170.30	541	03.6298.14.DA	104
03.5925.14	562	03.6002.18	563	03.6022.14.DA	562	03.6042.14	564	03.6170.GN	541	03.6302.14B	97
03.5925.18	562	03.6002.18.DA	563	03.6022.18	562	03.6042.14.DA	564	03.6174.05A	541	03.6302.14BCB	97
03.5925.B1	562	03.6002.B1	563	03.6022.18.DA	562	03.6042.18	564	03.6174.14A	541	03.6302.14CDA	97
03.5926.14	562	03.6002.B1.DA	563	03.6022.B1	562	03.6042.18.DA	564	03.6174.30A	541	03.6303.14B	97
03.5926.18	562	03.6003.14	563	03.6022.B1.DA	562	03.6042.B1	564	03.6174.GNA	541	03.6303.14BCB	97
03.5926.B1	562	03.6003.14.DA	563	03.6023.14	562	03.6042.B1.DA	564	03.6260.14.CB	105	03.6303.14CDA	97
03.5927.14	562	03.6003.18	563	03.6023.14.DA	562	03.6043.14	564	03.6260.14ADA	105	03.6305.14	98
03.5927.18	562	03.6003.18.DA	563	03.6023.18	562	03.6043.14.DA	564	03.6260.14B	105	03.6305.14.CB	98
03.5927.B1	562	03.6003.B1	563	03.6023.18.DA	562	03.6043.18	564	03.6261.14.CB	105	03.6305.14ADA	98
03.5930.14	565	03.6003.B1.DA	563	03.6023.B1	562	03.6043.18.DA	564	03.6261.14ADA	105	03.6306.14	98
03.5930.18	565	03.6004.14	563	03.6023.B1.DA	562	03.6043.B1	564	03.6261.14B	105	03.6306.14.CB	98
03.5930.B1	565	03.6004.14.DA	563	03.6024.14	562	03.6043.B1.DA	564	03.6262.14.CB	105	03.6306.14ADA	98
03.5931.14	565	03.6004.18	563	03.6024.14.DA	562	03.6044.14	564	03.6262.14ADA	105	03.6415.05B	453
03.5931.18	565	03.6004.18.DA	563	03.6024.18	562	03.6044.14.DA	564	03.6262.14B	105	03.6415.14B	453
03.5931.B1	565	03.6004.B1	563	03.6024.18.DA	562	03.6044.18	564	03.6263.14.CB	105	03.6415.05B	453
03.5932.14	565	03.6004.B1.DA	563	03.6024.B1	562	03.6044.18.DA	564	03.6263.14ADA	105	03.6415.05B	453
03.5932.18	565	03.6005.14	563	03.6024.B1.DA	562	03.6044.B1	564	03.6263.14B	105	03.6416.14B	453
03.5932.B1	565	03.6005.14.DA	563	03.6025.14	562	03.6044.B1.DA	564	03.6272.06D	106	03.6416.40B	453
03.5933.14	565	03.6005.18	563	03.6025.14.DA	562	03.6045.14	564	03.6272.06DCB	106	03.6417.05B	453
03.5933.18	565	03.6005.18.DA	563	03.6025.18	562	03.6045.14.DA	564	03.6272.06EDA	106	03.6417.14B	453
03.5933.B1	565	03.6005.B1	563	03.6025.18.DA	562	03.6045.18	564	03.6272.14D	106	03.6417.40B	453
03.5934.14	565	03.6005.B1.DA	563	03.6025.B1	562	03.6045.18.DA	564	03.6272.14DCB	106	03.6418.05B	453
03.5934.18	565	03.6006.14	563	03.6025.B1.DA	562	03.6045.B1	564	03.6272.14EDA	106	03.6418.14B	453
03.5934.B1	565	03.6006.14.DA	563	03.6026.14	562	03.6045.B1.DA	564	03.6272.30D	106	03.6418.40B	453
03.5935.14	565	03.6006.18	563	03.6026.14.DA	562	03.6046.14	564	03.6272.30DCB	106	03.6500.14A	409
03.5935.18	565	03.6006.18.DA	563	03.6026.18	562	03.6046.14.DA	564	03.6272.30EDA	106	03.6500.14ADA	409
03.5935.B1	565	03.6006.B1	563	03.6026.18.DA	562	03.6046.18	564	03.6273.06D	106	03.6500.40A	409
03.5936.14	565	03.6006.B1.DA	563	03.6026.B1	562	03.6046.18.DA	564	03.6273.06DCB	106	03.6500.40ADA	409
03.5936.18	565	03.6007.14	563	03.6026.B1.DA	562	03.6046.B1	564	03.6273.06EDA	106	03.6501.14A	409
03.5936.B1	565	03.6007.14.DA	563	03.6027.14	562	03.6046.B1.DA	564	03.6273.14D	106	03.6501.14ADA	409
03.5937.14	565	03.6007.18	563	03.6027.14.DA	562	03.6047.14	564	03.6273.14DCB	106	03.6501.40A	409
03.5937.18	565	03.6007.18.DA	563	03.6027.18	562	03.6047.14.DA	564	03.6273.14EDA	106	03.6501.40ADA	409
03.5937.B1	565	03.6007.B1	563	03.6027.18.DA	562	03.6047.18	564	03.6273.30D	106	03.6503.14A	409
03.5940.14	564	03.6007.B1.DA	563	03.6027.B1	562	03.6047.18.DA	564	03.6273.30DCB	106	03.6503.14ADA	409
03.5940.18	564	03.6010.14	566	03.6027.B1.DA	562	03.6047.18.DA	564	03.6273.30EDA	106	03.6503.40A	409
03.5940.B1	564	03.6010.14.DA	566	03.6030.14	565	03.6047.B1.DA	564	03.6274.14A	106	03.6503.40ADA	409
03.5941.14	564	03.6010.18	566	03.6030.14.DA	565	03.6050.14	567	03.6274.14ACB	106	03.6504.14A	409
03.5941.18	564	03.6010.18.DA	566	03.6030.18	565	03.6050.14.DA	567	03.6274.14ADA	106	03.6504.14ADA	409
03.5941.B1	564	03.6010.B1	566	03.6030.18.DA	565	03.6050.18	567	03.6274.40A	106	03.6504.40A	409
03.5942.14	564	03.6010.B1.DA	566	03.6030.B1	565	03.6050.18.DA	567	03.6274.40ACB	106	03.6504.40ADA	409
03.5942.18	564	03.6011.14	566	03.6030.B1.DA	565	03.6050.B1	567	03.6274.40ADA	106	03.6506.14A	408
03.5942.B1	564	03.6011.14.DA	566	03.6031.14	565	03.6050.B1.DA	567	03.6275.14A	106	03.6506.14ADA	408
03.5943.14	564	03.6011.18	566	03.6031.14.DA	565	03.6051.14	567	03.6275.14ACB	106	03.6506.40A	408
03.5943.18	564	03.6011.18.DA	566	03.6031.18	565	03.6051.14.DA	567	03.6275.14ADA	106	03.6506.40ADA	408
03.5943.B1	564	03.6011.B1	566	03.6031.18.DA	565	03.6051.18	567	03.6275.40A	106	03.6507.14A	408
03.5944.14	564	03.6011.B1.DA	566	03.6031.B1	565	03.6051.18.DA	567	03.6275.40ACB	106	03.6507.14ADA	408
03.5944.18	564	03.6012.14	566	03.6031.B1.DA	565	03.6051.B1	567	03.6275.40ADA	106	03.6507.40A	408
03.5944.B1	564	03.6012.14.DA	566	03.6032.14	565	03.6051.B1.DA	567	03.6277.14A	106	03.6507.40ADA	408
03.5945.14	564	03.6012.18	566	03.6032.14.DA	565	03.6052.14	567	03.6277.14ACB	106	03.6509.14A	408
03.5945.18	564	03.6012.18.DA	566	03.6032.18	565	03.6052.14.DA	567	03.6277.14ADA	106	03.6509.14ADA	408
03.5945.B1	564	03.6012.B1	566	03.6032.18.DA	565	03.6052.18	567	03.6277.40A	106	03.6509.40A	408
03.5946.14	564	03.6012.B1.DA	566	03.6032.B1	565	03.6052.18.DA	567	03.6277.40ACB	106	03.6509.40ADA	408
03.5946.18	564	03.6013.14	566	03.6032.B1.DA	565	03.6052.B1	567	03.6277.40ADA	106	03.6510.14A	408
03.5946.B1	564	03.6013.14.DA	566	03.6033.14	565	03.6052.B1.DA	567	03.6278.14A	106	03.6510.14ADA	408
03.5947.14	564	03.6013.18	566	03.6033.14.DA	565	03.6053.14	567	03.6278.14ACB	106	03.6510.40A	408
03.5947.18	564	03.6013.18.DA	566	03.6033.18	565	03.6053.14.DA	567	03.6278.14ADA	106	03.6510.40ADA	408
03.5947.B1	564	03.6013.B1	566	03.6033.18.DA	565	03.6053.18	567	03.6278.40A	106	03.6512.14A	410
03.5950.14	567	03.6013.B1.DA	566	03.6033.B1	565	03.6053.18.DA	567	03.6278.40ACB	106	03.6512.14ADA	410
03.5950.18	567	03.6014.14	566	03.6033.B1.DA	565	03.6053.B1	567	03.6278.40ADA	106	03.6512.40A	410
03.5950.B1	567	03.6014.14.DA	566	03.6034.14	565	03.6053.B1.DA	567	03.6284.14	99	03.6512.40ADA	410
03.5951.14	567	03.6014.18	566	03.6034.14.DA	565	03.6054.14	567	03.6284.14.CB	99	03.6514.14A	410
03.5951.18	567	03.6014.18.DA	566	03.6034.18	565	03.6054.14.DA	567	03.6284.14ADA	99	03.6514.14ADA	410
03.5951.B1	567	03.6014.B1	566	03.6034.18.DA	565	03.6054.18	567	03.6284.40	99	03.6514.40A	410
03.5952.14	567	03.6014.B1.DA	566	03.6034.B1	565	03.6054.18.DA	567	03.6284.40.CB	99	03.6514.40ADA	410
03.5952.18	567	03.6015.14	566	03.6034.B1.DA	565	03.6054.B1	567	03.6284.40ADA	99	03.6520.14A	409
03.5952.B1	567	03.6015.14.DA	566	03.6035.14	565	03.6054.B1.DA	567	03.6285.14	99	03.6520.14ADA	409
03.5953.14	567	03.6015.18	566	03.6035.14.DA	565	03.6055.14	567	03.6285.14.CB	99	03.6520.40A	409
03.5953.18	567	03.6015.18.DA	566	03.6035.18	565	03.6055.14.DA	567	03.6285.14ADA	99	03.6520.40ADA	409
03.5953.B1	567	03.6015.B1	566	03.6035.18.DA	565	03.6055.18	567	03.6285.40	99	03.6521.14A	409
03.5954.14	567	03.6015.B1.DA	566	03.6035.B1	565	03.6055.18.DA	567	03.6285.40.CB	99	03.6521.14ADA	409
03.5954.18	567	03.6016.14	566	03.6035.B1.DA	565	03.6055.B1	567	03.6285.40ADA	99	03.6521.40A	409
03.5954.B1	567	03.6016.14.DA	566	03.6036.14	565	03.6055.B1.DA	567	03.6286.14	99	03.6521.40ADA	409
03.5955.14	567	03.6016.18	566	03.6036.14.DA	565	03.6056.14	567	03.6286.14.CB	99	03.6523.14A	409
03.5955.18	567	03.6016.18.DA	566	03.6036.18	565	03.6056.14.DA	567	03.6286.14ADA	99	03.6523.14ADA	409
03.5955.B1	567	03.6016.B1	566	03.6036.18.DA	565	03.6056.18	567	03.6286.40	99	03.6523.40A	409
03.5956.14	567	03.6016.B1.DA	566	03.6036.B1	565	03.6056.18.DA	567	03.6286.40.CB	99	03.6523.40ADA	409
03.5956.18	567	03.6017.14	566	03.6036.B1.DA	565	03.6056.B1	567	03.6286.40ADA	99	03.6524.14A	409
03.5956.B1	567	03.6017.14.DA	566	03.6037.14	565	03.6056.B1.DA	567	03.6287.14	99	03.6524.14ADA	409
03.5957.14	567	03.6017.18	566	03.6037.14.DA	565	03.6057.14	567	03.6287.14.CB	99	03.6524.40A	409
03.5957.18	567	03.6017.18.DA	566	03.6037.18	565	03.6057.14.DA	567	03.6287.14ADA	99	03.6524.40ADA	409
03.5957.B1	567	03.6017.B1	566	03.6037.18.DA	565	03.6057.18	567	03.6287.40	99	03.6526.14A	408
03.6000.14	563	03.6017.B1.DA	566</								

QUICK SEARCH OF PRODUCT

Ref.	Page	Ref.	Page	Ref.	Page	Ref.	Page	Ref.	Page	Ref.	Page
03.6530.14ADA	408	03.6604.14	432	03.6800.40ADA	436	03.6818.40A	435	03.7305.14ACB	229	03.7329.14A	241
03.6530.40A	408	03.6604.14.DA	432	03.6801.14A	436	03.6818.40ADA	435	03.7305.14ADA	229	03.7329.14ACB	241
03.6530.40ADA	408	03.6604.40	432	03.6801.14ADA	436	03.6819.14A	435	03.7305.14ANI	229	03.7329.14ADA	241
03.6532.14A	410	03.6604.40.DA	432	03.6801.40A	436	03.6819.14ADA	435	03.7305.40A	229	03.7329.14ANI	241
03.6532.14ADA	410	03.6605.14	432	03.6801.40ADA	436	03.6819.40A	435	03.7305.40ACB	229	03.7329.40A	241
03.6532.40A	410	03.6605.14.DA	432	03.6802.14A	436	03.6819.40ADA	435	03.7305.40ADA	229	03.7329.40ACB	241
03.6532.40ADA	410	03.6605.40	432	03.6802.14ADA	436	03.6820.14A	435	03.7305.40ANI	229	03.7329.40ADA	241
03.6534.14A	410	03.6605.40.DA	432	03.6802.40A	436	03.6820.14ADA	435	03.7308.14A	233	03.7329.40ANI	241
03.6534.14ADA	410	03.6606.14	432	03.6802.40ADA	436	03.6820.40A	435	03.7308.14ACB	233	03.7350.14A	245
03.6534.40A	410	03.6606.14.DA	432	03.6803.14A	435	03.6820.40ADA	435	03.7308.14ADA	233	03.7350.14ACB	245
03.6534.40ADA	410	03.6606.40	432	03.6803.14ADA	435	03.6821.14A	435	03.7308.14ANI	233	03.7350.14ADA	245
03.6560.14A	412	03.6606.40.DA	432	03.6803.40A	435	03.6821.14ADA	435	03.7308.40A	233	03.7350.14ANI	245
03.6560.14ADA	412	03.6607.14	432	03.6803.40ADA	435	03.6821.40A	435	03.7308.40ACB	233	03.7350.40A	245
03.6560.40A	412	03.6607.14.DA	432	03.6804.14A	435	03.6821.40ADA	435	03.7308.40ADA	233	03.7350.40ACB	245
03.6560.40ADA	412	03.6607.40	432	03.6804.14ADA	435	03.6822.14A	435	03.7308.40ANI	233	03.7350.40ADA	245
03.6561.14A	412	03.6607.40.DA	432	03.6804.40A	435	03.6822.14ADA	435	03.7309.14A	233	03.7350.40ANI	245
03.6561.14ADA	412	03.6608.14	432	03.6804.40ADA	435	03.6822.40A	435	03.7309.14ACB	233	03.7351.14A	245
03.6561.40A	412	03.6608.14.DA	432	03.6805.14A	435	03.6822.40ADA	435	03.7309.14ADA	233	03.7351.14ACB	245
03.6561.40ADA	412	03.6608.40	432	03.6805.14ADA	435	03.6823.14A	435	03.7309.14ANI	233	03.7351.14ADA	245
03.6562.14	412	03.6608.40.DA	432	03.6805.40A	435	03.6823.14ADA	435	03.7309.40A	233	03.7351.14ANI	245
03.6562.14.DA	412	03.6610.1B	431	03.6805.40ADA	435	03.6823.40A	435	03.7309.40ACB	233	03.7351.40A	245
03.6562.40	412	03.6610.1B.DA	431	03.6806.14A	435	03.6823.40ADA	435	03.7309.40ADA	233	03.7351.40ACB	245
03.6562.40.DA	412	03.6610.1C	431	03.6806.14ADA	435	03.6824.06A	434	03.7309.40ANI	233	03.7351.40ADA	245
03.6563.14	412	03.6610.1C.DA	431	03.6806.40A	435	03.6824.06ADA	434	03.7312.14A	233	03.7351.40ANI	245
03.6563.14.DA	412	03.6610.3B	431	03.6806.40ADA	435	03.6824.40A	434	03.7312.14ACB	233	03.7354.14A	245
03.6563.40A	412	03.6610.3B.DA	431	03.6807.14A	435	03.6824.40ADA	434	03.7312.14ADA	233	03.7354.14ACB	245
03.6563.40.DA	412	03.6610.3C	431	03.6807.14ADA	435	03.6825.06A	434	03.7312.14ANI	233	03.7354.14ADA	245
03.6564.14A	411	03.6610.3C.DA	431	03.6807.40A	435	03.6825.06ADA	434	03.7312.40A	233	03.7354.14ANI	245
03.6564.14ADA	411	03.6611.1B	431	03.6807.40ADA	435	03.6825.40A	434	03.7312.40ACB	233	03.7354.40A	245
03.6564.40A	411	03.6611.1B.DA	431	03.6808.14A	435	03.6825.40ADA	434	03.7312.40ADA	233	03.7354.40ACB	245
03.6564.40ADA	411	03.6611.1C	431	03.6808.14ADA	435	03.6826.06A	434	03.7312.40ANI	233	03.7354.40ADA	245
03.6565.14A	411	03.6611.1C.DA	431	03.6808.40A	435	03.6826.06ADA	434	03.7313.14A	233	03.7354.40ANI	245
03.6565.14ADA	411	03.6611.3B	431	03.6808.40ADA	435	03.6826.40A	434	03.7313.14ACB	233	03.7355.14A	245
03.6565.40A	411	03.6611.3B.DA	431	03.6809.1BA	434	03.6826.40ADA	434	03.7313.14ADA	233	03.7355.14ACB	245
03.6565.40ADA	411	03.6611.3C	431	03.6809.1BADA	434	03.6827.06A	437	03.7313.14ANI	233	03.7355.14ADA	245
03.6566.14	411	03.6611.3C.DA	431	03.6809.1CA	434	03.6827.06ADA	437	03.7313.40A	233	03.7355.14ANI	245
03.6566.14.DA	411	03.6613.1B	433	03.6809.1CADA	434	03.6827.40A	437	03.7313.40ACB	233	03.7355.40A	245
03.6566.40	411	03.6613.1B.DA	433	03.6809.3BA	434	03.6827.40ADA	437	03.7313.40ADA	233	03.7355.40ACB	245
03.6566.40.DA	411	03.6613.1C	433	03.6809.3BADA	434	03.6828.06A	437	03.7313.40ANI	233	03.7355.40ADA	245
03.6567.14	411	03.6613.1C.DA	433	03.6809.3CA	434	03.6828.06ADA	437	03.7316.14A	237	03.7355.40ANI	245
03.6567.14.DA	411	03.6613.3B	433	03.6809.3CADA	434	03.6828.40A	437	03.7316.14ACB	237	03.7358.14A	249
03.6567.40A	411	03.6613.3B.DA	433	03.6810.1BA	434	03.6828.40ADA	437	03.7316.14ADA	237	03.7358.14ACB	249
03.6567.40.DA	411	03.6613.3C	433	03.6810.1BADA	434	03.6829.06A	437	03.7316.14ANI	237	03.7358.14ADA	249
03.6568.14A	413	03.6613.3C.DA	433	03.6810.1CA	434	03.6829.06ADA	437	03.7316.40A	237	03.7358.14ANI	249
03.6568.14ADA	413	03.6614.1B	433	03.6810.1CADA	434	03.6829.40A	437	03.7316.40ACB	237	03.7358.40A	249
03.6568.40A	413	03.6614.1B.DA	433	03.6810.3BA	434	03.6829.40ADA	437	03.7316.40ADA	237	03.7358.40ACB	249
03.6568.40ADA	413	03.6614.1C	433	03.6810.3BADA	434	03.7000.14	96	03.7316.40ANI	237	03.7358.40ADA	249
03.6569.14	413	03.6614.1C.DA	433	03.6810.3CA	434	03.7000.14.CB	96	03.7317.14A	237	03.7358.40ANI	249
03.6569.14.DA	413	03.6614.3B	433	03.6810.3CADA	434	03.7000.14ADA	96	03.7317.14ACB	237	03.7359.14A	249
03.6569.40A	413	03.6614.3B.DA	433	03.6811.1BA	434	03.7001.14	96	03.7317.14ADA	237	03.7359.14ACB	249
03.6569.40.DA	413	03.6614.3C	433	03.6811.1BADA	434	03.7001.14.CB	96	03.7317.14ANI	237	03.7359.14ADA	249
03.6570.14A	412	03.6614.3C.DA	433	03.6811.1CA	434	03.7001.14ADA	96	03.7317.40A	237	03.7359.14ANI	249
03.6570.14ADA	412	03.6618.14	432	03.6811.1CADA	434	03.7002.14	96	03.7317.40ACB	237	03.7359.40A	249
03.6570.40A	412	03.6618.14.DA	432	03.6811.3BA	434	03.7002.14.CB	96	03.7317.40ADA	237	03.7359.40ACB	249
03.6570.40ADA	412	03.6618.40	432	03.6811.3BADA	434	03.7002.14ADA	96	03.7317.40ANI	237	03.7359.40ADA	249
03.6571.14A	412	03.6618.40.DA	432	03.6811.3CA	434	03.7003.14	96	03.7320.14A	237	03.7359.40ANI	249
03.6571.14ADA	412	03.6619.14	432	03.6811.3CADA	434	03.7003.14.CB	96	03.7320.14ACB	237	03.7362.14A	249
03.6571.40A	412	03.6619.14.DA	432	03.6812.1BA	437	03.7003.14ADA	96	03.7320.14ADA	237	03.7362.14ACB	249
03.6571.40ADA	412	03.6619.40	432	03.6812.1BADA	437	03.7004.14	96	03.7320.14ANI	237	03.7362.14ADA	249
03.6572.14	412	03.6619.40.DA	432	03.6812.1CA	437	03.7004.14.CB	96	03.7320.40A	237	03.7362.14ANI	249
03.6572.14.DA	412	03.6620.14	432	03.6812.1CADA	437	03.7004.14ADA	96	03.7320.40ACB	237	03.7362.40A	249
03.6572.40	412	03.6620.14.DA	432	03.6812.3BA	437	03.7005.14	96	03.7320.40ADA	237	03.7362.40ACB	249
03.6572.40.DA	412	03.6620.40	432	03.6812.3BADA	437	03.7005.14.CB	96	03.7320.40ANI	237	03.7362.40ADA	249
03.6573.14	412	03.6620.40.DA	432	03.6812.3CA	437	03.7005.14ADA	96	03.7321.14A	237	03.7362.40ANI	249
03.6573.14.DA	412	03.6621.14	432	03.6812.3CADA	437	03.7006.14	96	03.7321.14ACB	237	03.7363.14A	249
03.6573.40	412	03.6621.14.DA	432	03.6813.1BA	437	03.7006.14.CB	96	03.7321.14ADA	237	03.7363.14ACB	249
03.6573.40.DA	412	03.6621.40	432	03.6813.1BADA	437	03.7006.14ADA	96	03.7321.14ANI	237	03.7363.14ADA	249
03.6574.14A	411	03.6621.40.DA	432	03.6813.1CA	437	03.7007.14	96	03.7321.40A	237	03.7363.14ANI	249
03.6574.14ADA	411	03.6622.14	432	03.6813.1CADA	437	03.7007.14.CB	96	03.7321.40ACB	237	03.7363.40A	249
03.6574.40A	411	03.6622.14.DA	432	03.6813.3BA	437	03.7007.14ADA	96	03.7321.40ADA	237	03.7363.40ACB	249
03.6574.40ADA	411	03.6622.40	432	03.6813.3BADA	437	03.7300.14A	229	03.7321.40ANI	237	03.7363.40ADA	249
03.6575.14A	411	03.6622.40.DA	432	03.6813.3CA	437	03.7300.14ACB	229	03.7324.14A	241	03.7363.40ANI	249
03.6575.14ADA	411	03.6623.14	432	03.6813.3CADA	437	03.7300.14ADA	229	03.7324.14ACB	241	03.7366.14A	253
03.6575.40A	411	03.6623.14.DA	432	03.6814.1BA	437	03.7300.14ANI	229	03.7324.14ADA	241	03.7366.14ACB	253
03.6575.40ADA	411	03.6623.40	432	03.6814.1BADA	437	03.7300.40A	229	03.7324.14ANI	241	03.7366.14ADA	253
03.6576.14	411	03.6623.40.DA	432	03.6814.1CA	437	03.7300.40ACB	229	03.7324.40A	241	03.7366.14ANI	253
03.6576.14.DA	411	03.6625.06	431	03.6814.1CADA	437	03.7300.40ADA	229	03.7324.40ACB	241	03.7366.40A	253
03.6576.40	411	03.6625.06.DA	431	03.6814.3BA	437	03.7300.40ANI	229	03.7324.40ADA	241	03.7366.40ACB	253
03.6576.40.DA	411	03.6625.40	431	03.6814.3BADA	437	03.7301.14A	229	03.7324.40ANI	241	03.7366.40ADA	253
03.6577.14	411	03.6625.40.DA	431	03.6814.3CA	437	03.7301.14ACB	229	03.7325.14A	241	03.7366.40ANI	253
03.6577.14.DA	411	03.6626.06	431	03.6814.3CADA	437	03.7301.14ADA	229	03.7325.14ACB	241	03.7367.14A	253
03.6577.40	411	03.6626.06.DA	431	03.6815.14A	436	03.7301.14ANI	229	03.7325.14ADA	241	03.7367	

QUICK SEARCH OF PRODUCT

Ref.	Page	Ref.	Page	Ref.	Page	Ref.	Page	Ref.	Page	Ref.	Page
03.7370.40ANI	253	03.8026.05.CB	127	03.8042.14ACB	123	03.8052.14ACB	24	03.8072.14.1V	126	03.8076.14.1V	26
03.7371.14A	253	03.8026.05ADA	127	03.8042.14ADA	23	03.8052.14ACB	124	03.8072.14.CB	26	03.8076.14.1V	126
03.7371.14ACB	253	03.8026.14	127	03.8042.14ADA	123	03.8052.14ADA	24	03.8072.14.CB	126	03.8076.14.CB	26
03.7371.14ADA	253	03.8026.14.1V	127	03.8042.40A	23	03.8052.14ADA	124	03.8072.14.DA	26	03.8076.14.CB	126
03.7371.14ANI	253	03.8026.14.CB	127	03.8042.40A	123	03.8052.40A	24	03.8072.14ADA	126	03.8076.14.DA	26
03.7371.40A	253	03.8026.14ADA	127	03.8042.40A1V	23	03.8052.40A	124	03.8072.40	26	03.8076.14ADA	126
03.7371.40ACB	253	03.8026.40	127	03.8042.40A1V	123	03.8052.40A1V	24	03.8072.40	126	03.8076.40	26
03.7371.40ADA	253	03.8026.40.1V	127	03.8042.40ACB	23	03.8052.40A1V	124	03.8072.40.1V	26	03.8076.40	126
03.7371.40ANI	253	03.8026.40.CB	127	03.8042.40ACB	123	03.8052.40ACB	24	03.8072.40.1V	126	03.8076.40.1V	26
03.7374.14A	257	03.8026.40ADA	127	03.8042.40ADA	23	03.8052.40ACB	124	03.8072.40.CB	26	03.8076.40.1V	126
03.7374.14ACB	257	03.8027.05	127	03.8042.40ADA	123	03.8052.40ADA	24	03.8072.40.CB	126	03.8076.40.CB	26
03.7374.14ADA	257	03.8027.05.1V	127	03.8043.05A	23	03.8052.40ADA	124	03.8072.40.DA	26	03.8076.40.CB	126
03.7374.14ANI	257	03.8027.05.CB	127	03.8043.05A	123	03.8053.05A	24	03.8072.40ADA	126	03.8076.40.DA	26
03.7374.40A	257	03.8027.05ADA	127	03.8043.05A1V	23	03.8053.05A	124	03.8073.05	26	03.8076.40ADA	126
03.7374.40ACB	257	03.8027.14	127	03.8043.05A1V	123	03.8053.05A1V	24	03.8073.05	126	03.8077.05	26
03.7374.40ADA	257	03.8027.14.1V	127	03.8043.05ACB	23	03.8053.05A1V	124	03.8073.05.1V	26	03.8077.05	126
03.7374.40ANI	257	03.8027.14.CB	127	03.8043.05ACB	123	03.8053.05ACB	24	03.8073.05.1V	126	03.8077.05.1V	26
03.7375.14A	257	03.8027.14ADA	127	03.8043.05ADA	23	03.8053.05ACB	124	03.8073.05.CB	26	03.8077.05.1V	126
03.7375.14ACB	257	03.8027.40	127	03.8043.05ADA	123	03.8053.05ADA	24	03.8073.05.CB	126	03.8077.05.CB	26
03.7375.14ADA	257	03.8027.40.1V	127	03.8043.14A	23	03.8053.05ADA	124	03.8073.05.DA	26	03.8077.05.CB	126
03.7375.14ANI	257	03.8027.40.CB	127	03.8043.14A	123	03.8053.14A	24	03.8073.05ADA	126	03.8077.05.DA	26
03.7375.40A	257	03.8027.40ADA	127	03.8043.14A1V	23	03.8053.14A	124	03.8073.14	26	03.8077.05ADA	126
03.7375.40ACB	257	03.8028.05	127	03.8043.14A1V	123	03.8053.14A1V	24	03.8073.14	126	03.8077.14	26
03.7375.40ADA	257	03.8028.05.1V	127	03.8043.14ACB	23	03.8053.14A1V	124	03.8073.14.1V	26	03.8077.14	126
03.7375.40ANI	257	03.8028.05.CB	127	03.8043.14ACB	123	03.8053.14ACB	24	03.8073.14.1V	126	03.8077.14.1V	26
03.7378.14A	257	03.8028.05ADA	127	03.8043.14ADA	23	03.8053.14ACB	124	03.8073.14.CB	26	03.8077.14.1V	126
03.7378.14ACB	257	03.8028.14	127	03.8043.14ADA	123	03.8053.14ADA	24	03.8073.14.CB	126	03.8077.14.CB	26
03.7378.14ADA	257	03.8028.14.1V	127	03.8043.40A	23	03.8053.14ADA	124	03.8073.14.DA	26	03.8077.14.CB	126
03.7378.14ANI	257	03.8028.14.CB	127	03.8043.40A	123	03.8053.40A	24	03.8073.14ADA	126	03.8077.14.DA	26
03.7378.40A	257	03.8028.14ADA	127	03.8043.40A1V	23	03.8053.40A	124	03.8073.40	26	03.8077.14ADA	126
03.7378.40ACB	257	03.8028.40	127	03.8043.40A1V	123	03.8053.40A1V	24	03.8073.40	126	03.8077.40	26
03.7378.40ADA	257	03.8028.40.1V	127	03.8043.40ACB	23	03.8053.40A1V	124	03.8073.40.1V	26	03.8077.40	126
03.7378.40ANI	257	03.8028.40.CB	127	03.8043.40ACB	123	03.8053.40ACB	24	03.8073.40.1V	126	03.8077.40.1V	26
03.7379.14A	257	03.8028.40ADA	127	03.8043.40ACB	23	03.8053.40ACB	124	03.8073.40.CB	26	03.8077.40.1V	126
03.7379.14ACB	257	03.8032.05A	22	03.8043.40ADA	123	03.8053.40ADA	24	03.8073.40.CB	126	03.8077.40.CB	26
03.7379.14ADA	257	03.8032.05A	122	03.8044.05A	23	03.8053.40ADA	124	03.8073.40.DA	26	03.8077.40.CB	126
03.7379.14ANI	257	03.8032.05A1V	22	03.8044.05A	123	03.8054.05A	24	03.8073.40ADA	126	03.8077.40.DA	26
03.7379.40A	257	03.8032.05A1V	122	03.8044.05A1V	23	03.8054.05A	124	03.8074.05	26	03.8077.40ADA	126
03.7379.40ACB	257	03.8032.05ACB	22	03.8044.05A1V	123	03.8054.05A1V	24	03.8074.05	126	03.8090.14	128
03.7379.40ADA	257	03.8032.05ACB	122	03.8044.05ACB	23	03.8054.05A1V	124	03.8074.05.1V	26	03.8090.14.1V	128
03.7379.40ANI	257	03.8032.05ADA	22	03.8044.05ACB	123	03.8054.05ACB	24	03.8074.05.1V	126	03.8090.14.CB	128
03.8000.14	121	03.8032.05ADA	122	03.8044.05ADA	23	03.8054.05ACB	124	03.8074.05.CB	26	03.8090.14ADA	128
03.8000.14.1V	121	03.8032.14A	22	03.8044.05ADA	123	03.8054.05ADA	24	03.8074.05.CB	126	03.8090.40	128
03.8000.14.CB	121	03.8032.14A	122	03.8044.14A	23	03.8054.05ADA	124	03.8074.05.DA	26	03.8090.40.1V	128
03.8000.14ADA	121	03.8032.14A1V	22	03.8044.14A	123	03.8054.14A	24	03.8074.05ADA	126	03.8090.40.CB	128
03.8001.14	121	03.8032.14A1V	122	03.8044.14A1V	23	03.8054.14A	124	03.8074.14	26	03.8090.40ADA	128
03.8001.14.1V	121	03.8032.14ACB	22	03.8044.14A1V	123	03.8054.14A1V	24	03.8074.14	126	03.8091.14	128
03.8001.14.CB	121	03.8032.14ACB	122	03.8044.14ACB	23	03.8054.14A1V	124	03.8074.14.1V	26	03.8091.14.1V	128
03.8001.14ADA	121	03.8032.14ADA	22	03.8044.14ACB	123	03.8054.14ACB	24	03.8074.14.1V	126	03.8091.14.CB	128
03.8002.14	121	03.8032.14ADA	122	03.8044.14ADA	23	03.8054.14ACB	124	03.8074.14.CB	26	03.8091.14ADA	128
03.8002.14.1V	121	03.8032.40A	22	03.8044.14ADA	123	03.8054.14ADA	24	03.8074.14.CB	126	03.8091.40	128
03.8002.14.CB	121	03.8032.40A	122	03.8044.40A	23	03.8054.14ADA	124	03.8074.14.DA	26	03.8091.40.1V	128
03.8002.14ADA	121	03.8032.40A1V	22	03.8044.40A	123	03.8054.40A	24	03.8074.14ADA	126	03.8091.40.CB	128
03.8003.14	121	03.8032.40A1V	122	03.8044.40A1V	23	03.8054.40A	124	03.8074.40	26	03.8091.40ADA	128
03.8003.14.1V	121	03.8032.40ACB	22	03.8044.40A1V	123	03.8054.40A1V	24	03.8074.40	126	03.8100.14	20
03.8003.14.CB	121	03.8032.40ACB	122	03.8044.40ACB	23	03.8054.40A1V	124	03.8074.40.1V	26	03.8100.14.1V	20
03.8003.14ADA	121	03.8032.40ADA	22	03.8044.40ACB	123	03.8054.40ACB	24	03.8074.40.1V	126	03.8100.14.CB	20
03.8004.14	121	03.8032.40ADA	122	03.8044.40ADA	23	03.8054.40ACB	124	03.8074.40.CB	26	03.8100.14.DA	20
03.8004.14.1V	121	03.8033.05A	22	03.8044.40ADA	123	03.8054.40ADA	24	03.8074.40.CB	126	03.8100.40	20
03.8004.14.CB	121	03.8033.05A	122	03.8045.05A	23	03.8054.40ADA	124	03.8074.40.DA	26	03.8100.40.1V	20
03.8004.14ADA	121	03.8033.05A1V	22	03.8045.05A	123	03.8055.14A	24	03.8074.40ADA	126	03.8100.40.CB	20
03.8005.14	121	03.8033.05A1V	122	03.8045.05A1V	23	03.8055.05A	124	03.8075.05	26	03.8100.40.DA	20
03.8005.14.1V	121	03.8033.05ACB	22	03.8045.05A1V	123	03.8055.05A1V	24	03.8075.05	126	03.8101.14	20
03.8005.14.CB	121	03.8033.05ACB	122	03.8045.05ACB	23	03.8055.05A1V	124	03.8075.05.1V	26	03.8101.14.1V	20
03.8005.14ADA	121	03.8033.05ADA	22	03.8045.05ACB	123	03.8055.05ACB	24	03.8075.05.1V	126	03.8101.14.CB	20
03.8006.14	121	03.8033.05ADA	122	03.8045.05ADA	23	03.8055.05ACB	124	03.8075.05.CB	26	03.8101.14.DA	20
03.8006.14.1V	121	03.8033.14A	22	03.8045.05ADA	123	03.8055.05ADA	24	03.8075.05.CB	126	03.8101.40	20
03.8006.14.CB	121	03.8033.14A	122	03.8045.14A	23	03.8055.05ADA	124	03.8075.05.DA	26	03.8101.40.1V	20
03.8006.14ADA	121	03.8033.14A1V	22	03.8045.14A	123	03.8055.14A	24	03.8075.05ADA	126	03.8101.40.CB	20
03.8007.14	121	03.8033.14A1V	122	03.8045.14A1V	23	03.8055.14A	124	03.8075.14	26	03.8101.40.DA	20
03.8007.14.1V	121	03.8033.14ACB	22	03.8045.14A1V	123	03.8055.14A1V	24	03.8075.14	126	03.8102.14	20
03.8007.14.CB	121	03.8033.14ACB	122	03.8045.14ACB	23	03.8055.14A1V	124	03.8075.14.1V	26	03.8102.14.1V	20
03.8007.14ADA	121	03.8033.14ADA	22	03.8045.14ACB	123	03.8055.14ACB	24	03.8075.14.1V	126	03.8102.14.CB	20
03.8008.14	121	03.8033.14ADA	122	03.8045.14ADA	23	03.8055.14ACB	124	03.8075.14.CB	26	03.8102.14.DA	20
03.8008.14.1V	121	03.8033.40A	22	03.8045.14ADA	123	03.8055.14ADA	24	03.8075.14.CB	126	03.8102.40	20
03.8008.14.CB	121	03.8033.40A	122	03.8045.40A	23	03.8055.14ADA	124	03.8075.14.DA	26	03.8102.40.1V	20
03.8008.14ADA	121	03.8033.40A1V	22	03.8045.40A	123	03.8055.40A	24	03.8075.14ADA	126	03.8102.40.CB	20
03.8009.14	121	03.8033.40A1V	122	03.8045.40A1V	23	03.8055.40A	124	03.8075.40	26	03.8102.40.DA	20
03.8009.14.1V	121	03.8033.40ACB	22	03.8045.40A1V	123	03.8055.40A1V	24	03.8075.40	126	03.8105.14	20
03.8009.14.CB	121	03.8033.40ACB	122	03.8045.40ACB	23	03.8055.40A1V	124	03.8075.40.1V	26	03.8105.14.1V	20
03.8009.14ADA	121	03.8033.40ADA	22	03.8045.40ACB	123	03.8055.40ACB	24	03.8075.40.1V	126	03.8105.14.CB	20
03.											

QUICK SEARCH OF PRODUCT

Ref.	Page	Ref.	Page	Ref.	Page	Ref.	Page	Ref.	Page	Ref.	Page
03.8107.14.1V	20	03.8132.RC.CB	28	03.8154.05	125	03.8300.14A	189	03.8321.40ANI	201	03.8363.40ADA	213
03.8107.14.CB	20	03.8132.RC.DA	28	03.8154.05.1V	25	03.8300.14ACB	189	03.8324.14A	205	03.8363.40ANI	213
03.8107.14.DA	20	03.8133.00	28	03.8154.05.1V	125	03.8300.14ADA	189	03.8324.14ACB	205	03.8366.14A	221
03.8107.40	20	03.8133.00.1V	28	03.8154.05.CB	25	03.8300.14ANI	189	03.8324.14ADA	205	03.8366.14ACB	221
03.8107.40.1V	20	03.8133.00.CB	28	03.8154.05.CB	125	03.8300.40A	189	03.8324.14ANI	205	03.8366.14ADA	221
03.8107.40.CB	20	03.8133.00.DA	28	03.8154.05.DA	25	03.8300.40ACB	189	03.8324.40A	205	03.8366.14ANI	221
03.8107.40.DA	20	03.8133.FU	28	03.8154.05ADA	125	03.8300.40ADA	189	03.8324.40ACB	205	03.8366.40A	221
03.8110.14	21	03.8133.FU.1V	28	03.8154.14	25	03.8300.40ANI	189	03.8324.40ADA	205	03.8366.40ACB	221
03.8110.14.1V	21	03.8133.FU.CB	28	03.8154.14	125	03.8301.14A	189	03.8324.40ANI	205	03.8366.40ADA	221
03.8110.14.CB	21	03.8133.FU.DA	28	03.8154.14.1V	25	03.8301.14ACB	189	03.8325.14A	205	03.8366.40ANI	221
03.8110.14.DA	21	03.8133.RC	28	03.8154.14.1V	125	03.8301.14ADA	189	03.8325.14ACB	205	03.8367.14A	221
03.8110.40	21	03.8133.RC.1V	28	03.8154.14.CB	25	03.8301.14ANI	189	03.8325.14ADA	205	03.8367.14ACB	221
03.8110.40.1V	21	03.8133.RC.CB	28	03.8154.14.CB	125	03.8301.40A	189	03.8325.14ANI	205	03.8367.14ADA	221
03.8110.40.CB	21	03.8133.RC.DA	28	03.8154.14.DA	25	03.8301.40ACB	189	03.8325.40A	205	03.8367.14ANI	221
03.8110.40.DA	21	03.8135.00	28	03.8154.14ADA	125	03.8301.40ADA	189	03.8325.40ACB	205	03.8367.40A	221
03.8111.14	21	03.8135.00.1V	28	03.8154.40	25	03.8301.40ANI	189	03.8325.40ADA	205	03.8367.40ACB	221
03.8111.14.1V	21	03.8135.00.CB	28	03.8154.40	125	03.8304.14A	189	03.8325.40ANI	205	03.8367.40ADA	221
03.8111.14.CB	21	03.8135.00.DA	28	03.8154.40.1V	25	03.8304.14ACB	189	03.8328.14A	205	03.8367.40ANI	221
03.8111.14.DA	21	03.8135.FU	28	03.8154.40.1V	125	03.8304.14ADA	189	03.8328.14ACB	205	03.8370.14A	221
03.8111.40	21	03.8135.FU.1V	28	03.8154.40.CB	25	03.8304.14ANI	189	03.8328.14ADA	205	03.8370.14ACB	221
03.8111.40.1V	21	03.8135.FU.CB	28	03.8154.40.CB	125	03.8304.40A	189	03.8328.14ANI	205	03.8370.14ADA	221
03.8111.40.CB	21	03.8135.FU.DA	28	03.8154.40.DA	25	03.8304.40ACB	189	03.8328.40A	205	03.8370.14ANI	221
03.8111.40.DA	21	03.8135.RC	28	03.8154.40ADA	125	03.8304.40ADA	189	03.8328.40ACB	205	03.8370.40A	221
03.8112.14	21	03.8135.RC.1V	28	03.8155.05	25	03.8304.40ANI	189	03.8328.40ADA	205	03.8370.40ACB	221
03.8112.14.1V	21	03.8135.RC.CB	28	03.8155.05	125	03.8305.14A	189	03.8328.40ANI	205	03.8370.40ADA	221
03.8112.14.CB	21	03.8135.RC.DA	28	03.8155.05.1V	25	03.8305.14ACB	189	03.8329.14A	205	03.8370.40ANI	221
03.8112.14.DA	21	03.8136.00	29	03.8155.05.1V	125	03.8305.14ADA	189	03.8329.14ACB	205	03.8371.14A	221
03.8112.40	21	03.8136.00.1V	29	03.8155.05.CB	25	03.8305.14ANI	189	03.8329.14ADA	205	03.8371.14ACB	221
03.8112.40.1V	21	03.8136.00.CB	29	03.8155.05.CB	125	03.8305.40A	189	03.8329.14ANI	205	03.8371.14ADA	221
03.8112.40.CB	21	03.8136.00.DA	29	03.8155.05.DA	25	03.8305.40ACB	189	03.8329.40A	205	03.8371.14ANI	221
03.8112.40.DA	21	03.8136.FU	29	03.8155.05ADA	125	03.8305.40ADA	189	03.8329.40ACB	205	03.8371.40A	221
03.8115.14	21	03.8136.FU.1V	29	03.8155.14	25	03.8305.40ANI	189	03.8329.40ADA	205	03.8371.40ACB	221
03.8115.14.1V	21	03.8136.FU.CB	29	03.8155.14	125	03.8308.14A	193	03.8329.40ANI	205	03.8371.40ADA	221
03.8115.14.CB	21	03.8136.FU.DA	29	03.8155.14.1V	25	03.8308.14ACB	193	03.8350.14A	209	03.8371.40ANI	221
03.8115.14.DA	21	03.8136.RC	29	03.8155.14.1V	125	03.8308.14ADA	193	03.8350.14ACB	209	03.8374.14A	225
03.8115.40	21	03.8136.RC.1V	29	03.8155.14.CB	25	03.8308.14ANI	193	03.8350.14ADA	209	03.8374.14ACB	225
03.8115.40.1V	21	03.8136.RC.CB	29	03.8155.14.CB	125	03.8308.40A	193	03.8350.14ANI	209	03.8374.14ADA	225
03.8115.40.CB	21	03.8136.RC.DA	29	03.8155.14.DA	25	03.8308.40ACB	193	03.8350.40A	209	03.8374.14ANI	225
03.8115.40.DA	21	03.8137.00	28	03.8155.14ADA	125	03.8308.40ADA	193	03.8350.40ACB	209	03.8374.40A	225
03.8116.14	21	03.8137.00.1V	28	03.8155.40	25	03.8308.40ANI	193	03.8350.40ADA	209	03.8374.40ACB	225
03.8116.14.1V	21	03.8137.00.CB	28	03.8155.40	125	03.8309.14A	193	03.8350.40ANI	209	03.8374.40ADA	225
03.8116.14.CB	21	03.8137.00.DA	28	03.8155.40.1V	25	03.8309.14ACB	193	03.8351.14A	209	03.8374.40ANI	225
03.8116.14.DA	21	03.8137.FU	28	03.8155.40.1V	125	03.8309.14ADA	193	03.8351.14ACB	209	03.8375.14A	225
03.8116.40	21	03.8137.FU.1V	28	03.8155.40.CB	25	03.8309.14ANI	193	03.8351.14ADA	209	03.8375.14ACB	225
03.8116.40.1V	21	03.8137.FU.CB	28	03.8155.40.CB	125	03.8309.40A	193	03.8351.14ANI	209	03.8375.14ADA	225
03.8116.40.CB	21	03.8137.FU.DA	28	03.8155.40.DA	25	03.8309.40ACB	193	03.8351.40A	209	03.8375.14ANI	225
03.8116.40.DA	21	03.8137.RC	28	03.8155.40ADA	125	03.8309.40ADA	193	03.8351.40ACB	209	03.8375.40A	225
03.8117.14	21	03.8137.RC.1V	28	03.8156.05	25	03.8309.40ANI	193	03.8351.40ADA	209	03.8375.40ACB	225
03.8117.14.1V	21	03.8137.RC.CB	28	03.8156.05	125	03.8312.14A	193	03.8351.40ANI	209	03.8375.40ADA	225
03.8117.14.CB	21	03.8137.RC.DA	28	03.8156.05.1V	25	03.8312.14ACB	193	03.8354.14A	209	03.8375.40ANI	225
03.8117.14.DA	21	03.8138.00	29	03.8156.05.1V	125	03.8312.14ADA	193	03.8354.14ACB	209	03.8378.14A	225
03.8117.40	21	03.8138.00.1V	29	03.8156.05.CB	25	03.8312.14ANI	193	03.8354.14ADA	209	03.8378.14ACB	225
03.8117.40.1V	21	03.8138.00.CB	29	03.8156.05.CB	125	03.8312.40A	193	03.8354.14ANI	209	03.8378.14ADA	225
03.8117.40.CB	21	03.8138.00.DA	29	03.8156.05.DA	25	03.8312.40ACB	193	03.8354.40A	209	03.8378.14ANI	225
03.8117.40.DA	21	03.8138.FU	29	03.8156.05ADA	125	03.8312.40ADA	193	03.8354.40ACB	209	03.8378.40A	225
03.8120.14	19	03.8138.FU.1V	29	03.8156.14	25	03.8312.40ANI	193	03.8354.40ADA	209	03.8378.40ACB	225
03.8120.40	19	03.8138.FU.CB	29	03.8156.14	125	03.8313.14A	193	03.8354.40ANI	209	03.8378.40ADA	225
03.8121.14	19	03.8138.FU.DA	29	03.8156.14.1V	25	03.8313.14ACB	193	03.8355.14A	209	03.8378.40ANI	225
03.8121.40	19	03.8138.RC	29	03.8156.14.1V	125	03.8313.14ADA	193	03.8355.14ACB	209	03.8379.14A	225
03.8122.14	19	03.8138.RC.1V	29	03.8156.14.CB	25	03.8313.14ANI	193	03.8355.14ADA	209	03.8379.14ACB	225
03.8122.40	19	03.8138.RC.CB	29	03.8156.14.CB	125	03.8313.40A	193	03.8355.14ANI	209	03.8379.14ADA	225
03.8130.00	28	03.8138.RC.DA	29	03.8156.14.DA	25	03.8313.40ACB	193	03.8355.40A	209	03.8379.14ANI	225
03.8130.00.1V	28	03.8140.14	27	03.8156.14ADA	125	03.8313.40ADA	193	03.8355.40ACB	209	03.8379.40A	225
03.8130.00.CB	28	03.8140.14.1V	27	03.8156.40	25	03.8313.40ANI	193	03.8355.40ADA	209	03.8379.40ACB	225
03.8130.00.DA	28	03.8140.14.CB	27	03.8156.40	125	03.8316.14A	201	03.8355.40ANI	209	03.8379.40ADA	225
03.8130.FU	28	03.8140.14.DA	27	03.8156.40.1V	25	03.8316.14ACB	201	03.8358.14A	213	03.8379.40ANI	225
03.8130.FU.1V	28	03.8140.40	27	03.8156.40.1V	125	03.8316.14ADA	201	03.8358.14ACB	213	03.8400.14	35
03.8130.FU.CB	28	03.8140.40.1V	27	03.8156.40.CB	25	03.8316.14ANI	201	03.8358.14ADA	213	03.8400.40	35
03.8130.FU.DA	28	03.8140.40.CB	27	03.8156.40.CB	125	03.8316.40A	201	03.8358.14ANI	213	03.8401.14	35
03.8130.RC	28	03.8140.40.DA	27	03.8156.40.DA	25	03.8316.40ACB	201	03.8358.40A	213	03.8401.40	35
03.8130.RC.1V	28	03.8141.14	27	03.8156.40ADA	125	03.8316.40ADA	201	03.8358.40ACB	213	03.8402.14	35
03.8130.RC.CB	28	03.8141.14.1V	27	03.8157.05	25	03.8316.40ANI	201	03.8358.40ADA	213	03.8402.40	35
03.8130.RC.DA	28	03.8141.14.CB	27	03.8157.05	125	03.8317.14A	201	03.8358.40ANI	213	03.8403.14	35
03.8131.00	28	03.8141.14.DA	27	03.8157.05.1V	25	03.8317.14ACB	201	03.8359.14A	213	03.8403.40	35
03.8131.00.1V	28	03.8141.40	27	03.8157.05.1V	125	03.8317.14ADA	201	03.8359.14ACB	213	03.8404.14	35
03.8131.00.CB	28	03.8141.40.1V	27	03.8157.05.CB	25	03.8317.14ANI	201	03.8359.14ADA	213	03.8404.40	35
03.8131.00.DA	28	03.8141.40.CB	27	03.8157.05.CB	125	03.8317.40A	201	03.8359.14ANI	213	03.8405.14	35
03.8131.FU	28	03.8141.40.DA	27	03.8157.05.DA	25	03.8317.40ACB	201	03.8359.40A	213	03.8405.40	35
03.8131.FU.1V	28	03.8142.14	27	03.8157.05ADA	125	03.8317.40ADA	201	03.8359.40ACB	213	03.8410.14	36
03.8131.FU.CB	28	03.8142.14.1V	27	03.8157.14	25	03.8317.40ANI	201	03.8359.40ADA	213	03.8410.40	36
03.8131.FU.DA	28	03.8142.14.CB	27	03.8157.14	125	03.8320.14A	201	03.8359.40ANI	213	03.8411.14	36
03.8131.RC	28	03.8142.14.DA	27	03.8157.14.1V	25	03.8320.14ACB	201	03.8362.14A	213	03.8411.40	36
03.8131.RC.1V	28	03.8142.40	27	03.8157.14.1V</							

QUICK SEARCH OF PRODUCT

Ref.	Page	Ref.	Page	Ref.	Page	Ref.	Page	Ref.	Page	Ref.	Page
03.8422.40	38	03.8602.14A	271	03.8645.14A	271	03.8840.14A	198	03.8861.40ANI	210	03.8885.40ADA	226
03.8423.14	38	03.8602.40A	271	03.8645.40A	271	03.8840.14ACB	198	03.8864.14A	210	03.8885.40ANI	226
03.8423.40	38	03.8602.EQA	271	03.8645.EQA	271	03.8840.14ADA	198	03.8864.14ACB	210	03.8888.14A	226
03.8424.14	38	03.8602.ERA	271	03.8645.ERA	271	03.8840.14ANI	198	03.8864.14ADA	210	03.8888.14ACB	226
03.8424.40	38	03.8602.ESA	271	03.8645.ESA	271	03.8840.40A	198	03.8864.14ANI	210	03.8888.14ADA	226
03.8425.14	38	03.8603.14A	270	03.8646.14A	271	03.8840.40ACB	198	03.8864.40A	210	03.8888.14ANI	226
03.8425.40	38	03.8603.40A	270	03.8646.40A	271	03.8840.40ADA	198	03.8864.40ACB	210	03.8888.40A	226
03.8430.14	33	03.8603.EQA	270	03.8646.EQA	271	03.8840.40ANI	198	03.8864.40ADA	210	03.8888.40ACB	226
03.8430.40	33	03.8603.ERA	270	03.8646.ERA	271	03.8841.14A	198	03.8864.40ANI	210	03.8888.40ADA	226
03.8431.14	33	03.8603.ESA	270	03.8646.ESA	271	03.8841.14ACB	198	03.8865.14A	210	03.8888.40ANI	226
03.8431.40	33	03.8604.14A	270	03.8647.14A	271	03.8841.14ADA	198	03.8865.14ACB	210	03.8889.14A	226
03.8432.14	33	03.8604.40A	270	03.8647.40A	271	03.8841.14ANI	198	03.8865.14ADA	210	03.8889.14ACB	226
03.8432.40	33	03.8604.EQA	270	03.8647.EQA	271	03.8841.40A	198	03.8865.14ANI	210	03.8889.14ADA	226
03.8440.14	36	03.8604.ERA	270	03.8647.ERA	271	03.8841.40ACB	198	03.8865.40A	210	03.8889.14ANI	226
03.8440.40	36	03.8604.ESA	270	03.8647.ESA	271	03.8841.40ADA	198	03.8865.40ACB	210	03.8889.40A	226
03.8441.14	37	03.8605.14A	271	03.8820.14A	186	03.8841.40ANI	198	03.8865.40ADA	210	03.8889.40ACB	226
03.8441.40	37	03.8605.40A	271	03.8820.14ACB	186	03.8844.14A	202	03.8865.40ANI	210	03.8889.40ADA	226
03.8442.14	36	03.8605.EQA	271	03.8820.14ADA	186	03.8844.14ACB	202	03.8868.14A	218	03.8889.40ANI	226
03.8442.40	36	03.8605.ERA	271	03.8820.14ANI	186	03.8844.14ADA	202	03.8868.14ACB	218	03.8892.14A	230
03.8443.14	37	03.8605.ESA	271	03.8820.40A	186	03.8844.14ANI	202	03.8868.14ADA	218	03.8892.14ACB	230
03.8443.40	37	03.8610.14A	270	03.8820.40ACB	186	03.8844.40A	202	03.8868.14ANI	218	03.8892.14ADA	230
03.8450.14	37	03.8610.40A	270	03.8820.40ADA	186	03.8844.40ACB	202	03.8868.40A	218	03.8892.14ANI	230
03.8450.40	37	03.8610.EQA	270	03.8820.40ANI	186	03.8844.40ADA	202	03.8868.40ACB	218	03.8892.40A	230
03.8451.14	37	03.8610.ERA	270	03.8821.14A	186	03.8844.40ANI	202	03.8868.40ADA	218	03.8892.40ACB	230
03.8451.40	37	03.8610.ESA	270	03.8821.14ACB	186	03.8845.14A	202	03.8868.40ANI	218	03.8892.40ADA	230
03.8500.14.1V	13	03.8611.14A	270	03.8821.14ADA	186	03.8845.14ACB	202	03.8869.14A	218	03.8892.40ANI	230
03.8500.14.CB	13	03.8611.40A	270	03.8821.14ANI	186	03.8845.14ADA	202	03.8869.14ACB	218	03.8893.14A	230
03.8500.14.DA	13	03.8611.EQA	270	03.8821.40A	186	03.8845.14ANI	202	03.8869.14ADA	218	03.8893.14ACB	230
03.8500.18.1V	13	03.8611.ERA	270	03.8821.40ACB	186	03.8845.40A	202	03.8869.14ANI	218	03.8893.14ADA	230
03.8500.18.CB	13	03.8611.ESA	270	03.8821.40ADA	186	03.8845.40ACB	202	03.8869.40A	218	03.8893.14ANI	230
03.8500.18.DA	13	03.8612.14A	271	03.8821.40ANI	186	03.8845.40ADA	202	03.8869.40ACB	218	03.8893.40A	230
03.8500.GN.1V	13	03.8612.40A	271	03.8824.14A	186	03.8845.40ANI	202	03.8869.40ADA	218	03.8893.40ACB	230
03.8500.GN.CB	13	03.8612.EQA	271	03.8824.14ACB	186	03.8848.14A	202	03.8869.40ANI	218	03.8893.40ADA	230
03.8500.GN.DA	13	03.8612.ERA	271	03.8824.14ADA	186	03.8848.14ACB	202	03.8872.14A	218	03.8893.40ANI	230
03.8501.14.1V	13	03.8612.ESA	271	03.8824.14ANI	186	03.8848.14ADA	202	03.8872.14ACB	218	03.8896.14A	230
03.8501.14.CB	13	03.8613.14A	270	03.8824.40A	186	03.8848.14ANI	202	03.8872.14ADA	218	03.8896.14ACB	230
03.8501.14.DA	13	03.8613.40A	270	03.8824.40ACB	186	03.8848.40A	202	03.8872.14ANI	218	03.8896.14ADA	230
03.8501.18.1V	13	03.8613.EQA	270	03.8824.40ADA	186	03.8848.40ACB	202	03.8872.40A	218	03.8896.14ANI	230
03.8501.18.CB	13	03.8613.ERA	270	03.8824.40ANI	186	03.8848.40ADA	202	03.8872.40ACB	218	03.8896.40A	230
03.8501.18.DA	13	03.8613.ESA	270	03.8825.14A	186	03.8848.40ANI	202	03.8872.40ADA	218	03.8896.40ACB	230
03.8501.GN.1V	13	03.8614.14A	270	03.8825.14ACB	186	03.8849.14A	202	03.8872.40ANI	218	03.8896.40ADA	230
03.8501.GN.CB	13	03.8614.40A	270	03.8825.14ADA	186	03.8849.14ACB	202	03.8873.14A	218	03.8896.40ANI	230
03.8501.GN.DA	13	03.8614.EQA	270	03.8825.14ANI	186	03.8849.14ADA	202	03.8873.14ACB	218	03.8897.14A	230
03.8505.14.1V	13	03.8614.ERA	270	03.8825.40A	186	03.8849.14ANI	202	03.8873.14ADA	218	03.8897.14ACB	230
03.8505.14.CB	13	03.8614.ESA	270	03.8825.40ACB	186	03.8849.40A	202	03.8873.14ANI	218	03.8897.14ADA	230
03.8505.14.DA	13	03.8615.14A	271	03.8825.40ADA	186	03.8849.40ACB	202	03.8873.40A	218	03.8897.14ANI	230
03.8505.18.1V	13	03.8615.40A	271	03.8825.40ANI	186	03.8849.40ADA	202	03.8873.40ACB	218	03.8897.40A	230
03.8505.18.CB	13	03.8615.EQA	271	03.8828.14A	190	03.8849.40ANI	202	03.8873.40ADA	218	03.8897.40ACB	230
03.8505.18.DA	13	03.8615.ERA	271	03.8828.14ACB	190	03.8852.14A	206	03.8873.40ANI	218	03.8897.40ADA	230
03.8505.GN.1V	13	03.8615.ESA	271	03.8828.14ADA	190	03.8852.14ACB	206	03.8876.14A	222	03.8897.40ANI	230
03.8505.GN.CB	13	03.8630.14A	271	03.8828.14ANI	190	03.8852.14ADA	206	03.8876.14ACB	222	03.8900.14A	234
03.8505.GN.DA	13	03.8630.40A	271	03.8828.40A	190	03.8852.14ANI	206	03.8876.14ADA	222	03.8900.14ACB	234
03.8506.14.1V	13	03.8630.EQA	271	03.8828.40ACB	190	03.8852.40A	206	03.8876.14ANI	222	03.8900.14ADA	234
03.8506.14.CB	13	03.8630.ERA	271	03.8828.40ADA	190	03.8852.40ACB	206	03.8876.40A	222	03.8900.14ANI	234
03.8506.14.DA	13	03.8630.ESA	271	03.8828.40ANI	190	03.8852.40ADA	206	03.8876.40ACB	222	03.8900.40A	234
03.8506.18.1V	13	03.8631.14A	271	03.8829.14A	190	03.8852.40ANI	206	03.8876.40ADA	222	03.8900.40ACB	234
03.8506.18.CB	13	03.8631.40A	271	03.8829.14ACB	190	03.8853.14A	206	03.8876.40ANI	222	03.8900.40ADA	234
03.8506.18.DA	13	03.8631.EQA	271	03.8829.14ADA	190	03.8853.14ACB	206	03.8877.14A	222	03.8900.40ANI	234
03.8506.GN.1V	13	03.8631.ERA	271	03.8829.14ANI	190	03.8853.14ADA	206	03.8877.14ACB	222	03.8901.14A	234
03.8506.GN.CB	13	03.8631.ESA	271	03.8829.40A	190	03.8853.14ANI	206	03.8877.14ADA	222	03.8901.14ACB	234
03.8506.GN.DA	13	03.8635.14A	271	03.8829.40ACB	190	03.8853.40A	206	03.8877.14ANI	222	03.8901.14ADA	234
03.8510.14	14	03.8635.40A	271	03.8829.40ADA	190	03.8853.40ACB	206	03.8877.40A	222	03.8901.14ANI	234
03.8510.18	14	03.8635.EQA	271	03.8829.40ANI	190	03.8853.40ADA	206	03.8877.40ACB	222	03.8901.40A	234
03.8510.GN	14	03.8635.ERA	271	03.8832.14A	190	03.8853.40ANI	206	03.8877.40ADA	222	03.8901.40ACB	234
03.8511.14	14	03.8635.ESA	271	03.8832.14ACB	190	03.8856.14A	206	03.8877.40ANI	222	03.8901.40ADA	234
03.8511.18	14	03.8636.14A	271	03.8832.14ADA	190	03.8856.14ACB	206	03.8880.14A	222	03.8901.40ANI	234
03.8511.GN	14	03.8636.40A	271	03.8832.14ANI	190	03.8856.14ADA	206	03.8880.14ACB	222	03.8904.14A	234
03.8512.14	14	03.8636.EQA	271	03.8832.40A	190	03.8856.14ANI	206	03.8880.14ADA	222	03.8904.14ACB	234
03.8512.18	14	03.8636.ERA	271	03.8832.40ACB	190	03.8856.40A	206	03.8880.14ANI	222	03.8904.14ADA	234
03.8512.GN	14	03.8636.ESA	271	03.8832.40ADA	190	03.8856.40ACB	206	03.8880.40A	222	03.8904.14ANI	234
03.8513.14	14	03.8640.14A	270	03.8832.40ANI	190	03.8856.40ADA	206	03.8880.40ACB	222	03.8904.40A	234
03.8513.18	14	03.8640.40A	270	03.8833.14A	190	03.8856.40ANI	206	03.8880.40ADA	222	03.8904.40ACB	234
03.8513.GN	14	03.8640.EQA	270	03.8833.14ACB	190	03.8857.14A	206	03.8880.40ANI	222	03.8904.40ADA	234
03.8514.14	14	03.8640.ERA	270	03.8833.14ADA	190	03.8857.14ACB	206	03.8881.14A	222	03.8904.40ANI	234
03.8514.18	14	03.8640.ESA	270	03.8833.14ANI	190	03.8857.14ADA	206	03.8881.14ACB	222	03.8905.14A	234
03.8514.GN	14	03.8641.14A	270	03.8833.40A	190	03.8857.14ANI	206	03.8881.14ADA	222	03.8905.14ACB	234
03.8520.14	14	03.8641.40A	270	03.8833.40ACB	190	03.8857.40A	206	03.8881.14ANI	222	03.8905.14ADA	234
03.8520.18	14	03.8641.EQA	270	03.8833.40ADA	190	03.8857.40ACB	206	03.8881.40A	222	03.8905.14ANI	234
03.8520.GN	14	03.8641.ERA	270	03.8833.40ANI	190	03.8857.40ADA	206	03.8881.40ACB	222	03.8905.40A	234
03.8521.14	14	03.8641.ESA	270	03.8836.14A	198	03.8857.40ANI	206	03.8881.40ADA	222	03.8905.40ACB	234
03.8521.18	14	03.8642.14A	271	03.8836.14ACB	198	03.8860.14A	210	03.8881.40ANI	222	03.8905.40ADA	234
03.8521.GN	14	03.8642.40A	271	03.8836.14ADA	198	03.8860.14ACB	210	03.8884.14A	226	03.8905.40ANI	234
03.8522.14	14	03.8642.EQA	271	03.8836.14ANI	198	03.8860.14ADA	210	03.8884.14ACB	226	03	

QUICK SEARCH OF PRODUCT

Ref.	Page	Ref.	Page	Ref.	Page	Ref.	Page	Ref.	Page	Ref.	Page
03.8909.40ACB	238	03.8933.40A	250	03.8961.14ACB	260	03.9120.14ADA	191	03.9150.14ACB	199	03.9200.14A	207
03.8909.40ADA	238	03.8933.40ACB	250	03.8961.14ADA	260	03.9120.14ANI	191	03.9150.14ADA	199	03.9200.14ACB	207
03.8909.40ANI	238	03.8933.40ADA	250	03.8961.40A	260	03.9120.40A	191	03.9150.14ANI	199	03.9200.14ADA	207
03.8912.14A	238	03.8933.40ANI	250	03.8961.40ACB	260	03.9120.40ACB	191	03.9150.40A	199	03.9200.14ANI	207
03.8912.14ACB	238	03.8936.14A	250	03.8961.40ADA	260	03.9120.40ADA	191	03.9150.40ACB	199	03.9200.40A	207
03.8912.14ADA	238	03.8936.14ACB	250	03.8964.14A	260	03.9120.40ANI	191	03.9150.40ADA	199	03.9200.40ACB	207
03.8912.14ANI	238	03.8936.14ADA	250	03.8964.14ACB	260	03.9121.14A	191	03.9150.40ANI	199	03.9200.40ADA	207
03.8912.40A	238	03.8936.14ANI	250	03.8964.14ADA	260	03.9121.14ACB	191	03.9151.14A	199	03.9200.40ANI	207
03.8912.40ACB	238	03.8936.40A	250	03.8964.40A	260	03.9121.14ADA	191	03.9151.14ACB	199	03.9201.14A	207
03.8912.40ADA	238	03.8936.40ACB	250	03.8964.40ACB	260	03.9121.14ANI	191	03.9151.14ADA	199	03.9201.14ACB	207
03.8912.40ANI	238	03.8936.40ADA	250	03.8964.40ADA	260	03.9121.40A	191	03.9151.14ANI	199	03.9201.14ADA	207
03.8913.14A	238	03.8936.40ANI	250	03.8965.14A	260	03.9121.40ACB	191	03.9151.40A	199	03.9201.14ANI	207
03.8913.14ACB	238	03.8937.14A	250	03.8965.14ACB	260	03.9121.40ADA	191	03.9151.40ACB	199	03.9201.40A	207
03.8913.14ADA	238	03.8937.14ACB	250	03.8965.14ADA	260	03.9121.40ANI	191	03.9151.40ADA	199	03.9201.40ACB	207
03.8913.14ANI	238	03.8937.14ADA	250	03.8965.40A	260	03.9125.14A	192	03.9151.40ANI	199	03.9201.40ADA	207
03.8913.40A	238	03.8937.14ANI	250	03.8965.40ACB	260	03.9125.14ACB	192	03.9155.14A	200	03.9201.40ANI	207
03.8913.40ACB	238	03.8937.40A	250	03.8965.40ADA	260	03.9125.14ADA	192	03.9155.14ACB	200	03.9205.14A	208
03.8913.40ADA	238	03.8937.40ACB	250	03.8968.14A	260	03.9125.14ANI	192	03.9155.14ADA	200	03.9205.14ACB	208
03.8913.40ANI	238	03.8937.40ADA	250	03.8968.14ACB	260	03.9125.40A	192	03.9155.14ANI	200	03.9205.14ADA	208
03.8916.14A	242	03.8937.40ANI	250	03.8968.14ADA	260	03.9125.40ACB	192	03.9155.40A	200	03.9205.14ANI	208
03.8916.14ACB	242	03.8940.14A	254	03.8968.40A	260	03.9125.40ADA	192	03.9155.40ACB	200	03.9205.40A	208
03.8916.14ADA	242	03.8940.14ACB	254	03.8968.40ACB	260	03.9125.40ANI	192	03.9155.40ADA	200	03.9205.40ACB	208
03.8916.14ANI	242	03.8940.14ADA	254	03.8968.40ADA	260	03.9126.14A	192	03.9155.40ANI	200	03.9205.40ADA	208
03.8916.40A	242	03.8940.14ANI	254	03.8969.14A	260	03.9126.14ACB	192	03.9156.14A	200	03.9205.40ANI	208
03.8916.40ACB	242	03.8940.40A	254	03.8969.14ACB	260	03.9126.14ADA	192	03.9156.14ACB	200	03.9206.14A	208
03.8916.40ADA	242	03.8940.40ACB	254	03.8969.14ADA	260	03.9126.14ANI	192	03.9156.14ADA	200	03.9206.14ACB	208
03.8916.40ANI	242	03.8940.40ADA	254	03.8969.40A	260	03.9126.40A	192	03.9156.14ANI	200	03.9206.14ADA	208
03.8917.14A	242	03.8940.40ANI	254	03.8969.40ACB	260	03.9126.40ACB	192	03.9156.40A	200	03.9206.14ANI	208
03.8917.14ACB	242	03.8941.14A	254	03.8969.40ADA	260	03.9126.40ADA	192	03.9156.40ACB	200	03.9206.40A	208
03.8917.14ADA	242	03.8941.14ACB	254	03.9100.14A	187	03.9126.40ANI	192	03.9156.40ADA	200	03.9206.40ACB	208
03.8917.14ANI	242	03.8941.14ADA	254	03.9100.14ACB	187	03.9130.14A	191	03.9156.40ANI	200	03.9206.40ADA	208
03.8917.40A	242	03.8941.14ANI	254	03.9100.14ADA	187	03.9130.14ACB	191	03.9160.14A	203	03.9206.40ANI	208
03.8917.40ACB	242	03.8941.40A	254	03.9100.14ANI	187	03.9130.14ADA	191	03.9160.14ACB	203	03.9210.14A	207
03.8917.40ADA	242	03.8941.40ACB	254	03.9100.40A	187	03.9130.14ANI	191	03.9160.14ADA	203	03.9210.14ACB	207
03.8917.40ANI	242	03.8941.40ADA	254	03.9100.40ACB	187	03.9130.40A	191	03.9160.14ANI	203	03.9210.14ADA	207
03.8920.14A	242	03.8941.40ANI	254	03.9100.40ADA	187	03.9130.40ACB	191	03.9160.40A	203	03.9210.14ANI	207
03.8920.14ACB	242	03.8944.14A	254	03.9100.40ANI	187	03.9130.40ADA	191	03.9160.40ACB	203	03.9210.40A	207
03.8920.14ADA	242	03.8944.14ACB	254	03.9101.14A	187	03.9130.40ANI	191	03.9160.40ADA	203	03.9210.40ACB	207
03.8920.14ANI	242	03.8944.14ADA	254	03.9101.14ACB	187	03.9131.14A	191	03.9160.40ANI	203	03.9210.40ADA	207
03.8920.40A	242	03.8944.14ANI	254	03.9101.14ADA	187	03.9131.14ACB	191	03.9161.14A	203	03.9210.40ANI	207
03.8920.40ACB	242	03.8944.40A	254	03.9101.14ANI	187	03.9131.14ADA	191	03.9161.14ACB	203	03.9211.14A	207
03.8920.40ADA	242	03.8944.40ACB	254	03.9101.40A	187	03.9131.14ANI	191	03.9161.14ADA	203	03.9211.14ACB	207
03.8920.40ANI	242	03.8944.40ADA	254	03.9101.40ACB	187	03.9131.40A	191	03.9161.14ANI	203	03.9211.14ADA	207
03.8921.14A	242	03.8944.40ANI	254	03.9101.40ADA	187	03.9131.40ACB	191	03.9161.40A	203	03.9211.14ANI	207
03.8921.14ACB	242	03.8945.14A	254	03.9101.40ANI	187	03.9131.40ADA	191	03.9161.40ACB	203	03.9211.40A	207
03.8921.14ADA	242	03.8945.14ACB	254	03.9105.14A	188	03.9131.40ANI	191	03.9161.40ADA	203	03.9211.40ACB	207
03.8921.14ANI	242	03.8945.14ADA	254	03.9105.14ACB	188	03.9135.14A	192	03.9161.40ANI	203	03.9211.40ADA	207
03.8921.40A	242	03.8945.14ANI	254	03.9105.14ADA	188	03.9135.14ACB	192	03.9165.14A	204	03.9211.40ANI	207
03.8921.40ACB	242	03.8945.40A	254	03.9105.14ANI	188	03.9135.14ADA	192	03.9165.14ACB	204	03.9215.14A	208
03.8921.40ADA	242	03.8945.40ACB	254	03.9105.40A	188	03.9135.14ANI	192	03.9165.14ADA	204	03.9215.14ACB	208
03.8921.40ANI	242	03.8945.40ADA	254	03.9105.40ACB	188	03.9135.40A	192	03.9165.14ANI	204	03.9215.14ADA	208
03.8924.14A	246	03.8945.40ANI	254	03.9105.40ADA	188	03.9135.40ACB	192	03.9165.40A	204	03.9215.14ANI	208
03.8924.14ACB	246	03.8948.14A	100	03.9105.40ANI	188	03.9135.40ADA	192	03.9165.40ACB	204	03.9215.40A	208
03.8924.14ADA	246	03.8948.14ACB	100	03.9106.14A	188	03.9135.40ANI	192	03.9165.40ADA	204	03.9215.40ACB	208
03.8924.14ANI	246	03.8948.14BDA	100	03.9106.14ACB	188	03.9136.14A	192	03.9165.40ANI	204	03.9215.40ADA	208
03.8924.40A	246	03.8948.40A	100	03.9106.14ADA	188	03.9136.14ACB	192	03.9166.14A	204	03.9215.40ANI	208
03.8924.40ACB	246	03.8948.40ACB	100	03.9106.14ANI	188	03.9136.14ADA	192	03.9166.14ACB	204	03.9216.14A	208
03.8924.40ADA	246	03.8948.40BDA	100	03.9106.40A	188	03.9136.14ANI	192	03.9166.14ADA	204	03.9216.14ACB	208
03.8924.40ANI	246	03.8949.14A	100	03.9106.40ACB	188	03.9136.40A	192	03.9166.14ANI	204	03.9216.14ADA	208
03.8925.14A	246	03.8949.14ACB	100	03.9106.40ADA	188	03.9136.40ACB	192	03.9166.40A	204	03.9216.14ANI	208
03.8925.14ACB	246	03.8949.14BDA	100	03.9106.40ANI	188	03.9136.40ADA	192	03.9166.40ACB	204	03.9216.40A	208
03.8925.14ADA	246	03.8949.40A	100	03.9110.14A	187	03.9136.40ANI	192	03.9166.40ADA	204	03.9216.40ACB	208
03.8925.14ANI	246	03.8949.40ACB	100	03.9110.14ACB	187	03.9140.14A	199	03.9166.40ANI	204	03.9216.40ADA	208
03.8925.40A	246	03.8949.40BDA	100	03.9110.14ADA	187	03.9140.14ACB	199	03.9170.14A	203	03.9216.40ANI	208
03.8925.40ACB	246	03.8952.14A	100	03.9110.14ANI	187	03.9140.14ADA	199	03.9170.14ACB	203	03.9220.14A	211
03.8925.40ADA	246	03.8952.14ACB	100	03.9110.40A	187	03.9140.14ANI	199	03.9170.14ADA	203	03.9220.14ACB	211
03.8925.40ANI	246	03.8952.14BDA	100	03.9110.40ACB	187	03.9140.40A	199	03.9170.14ANI	203	03.9220.14ADA	211
03.8928.14A	246	03.8952.40A	100	03.9110.40ADA	187	03.9140.40ACB	199	03.9170.40A	203	03.9220.14ANI	211
03.8928.14ACB	246	03.8952.40ACB	100	03.9110.40ANI	187	03.9140.40ADA	199	03.9170.40ACB	203	03.9220.40A	211
03.8928.14ADA	246	03.8952.40BDA	100	03.9111.14A	187	03.9140.40ANI	199	03.9170.40ADA	203	03.9220.40ACB	211
03.8928.14ANI	246	03.8953.14A	100	03.9111.14ACB	187	03.9141.14A	199	03.9170.40ANI	203	03.9220.40ADA	211
03.8928.40A	246	03.8953.14ACB	100	03.9111.14ADA	187	03.9141.14ACB	199	03.9171.14A	203	03.9220.40ANI	211
03.8928.40ACB	246	03.8953.14BDA	100	03.9111.14ANI	187	03.9141.14ADA	199	03.9171.14ACB	203	03.9221.14A	211
03.8928.40ADA	246	03.8953.40A	100	03.9111.40A	187	03.9141.14ANI	199	03.9171.14ADA	203	03.9221.14ACB	211
03.8928.40ANI	246	03.8953.40ACB	100	03.9111.40ACB	187	03.9141.40A	199	03.9171.14ANI	203	03.9221.14ADA	211
03.8929.14A	246	03.8953.40BDA	100	03.9111.40ADA	187	03.9141.40ACB	199	03.9171.40A	203	03.9221.14ANI	211
03.8929.14ACB	246	03.8956.14A	260	03.9111.40ANI	187	03.9141.40ADA	199	03.9171.40ACB	203	03.9221.40A	211
03.8929.14ADA	246	03.8956.14ACB	260	03.9115.14A	188	03.9141.40ANI	199	03.9171.40ADA	203	03.9221.40ACB	211
03.8929.14ANI	246	03.8956.14ADA	260	03.9115.14ACB	188	03.9145.14A	200	03.9171.40ANI	203	03.9221.40ADA	211
03.8929.40A	246	03.8956.40A	260	03.9115.14ADA	188	03.9145.14ACB	200	03.9175.14A	204	03.9221.40ANI	211
03.8929.40ACB	246	03.8956.40ACB	260	03.9115.14ANI	188	03.9145.14ADA	200	03.9175.14ACB	204	03.9225.14A	21

QUICK SEARCH OF PRODUCT

Ref.	Page	Ref.	Page	Ref.	Page	Ref.	Page	Ref.	Page	Ref.	Page
03.9446.14ACB	252	03.9476.14A	256	03.9635.14ACB	102	03.9764.14A	263	03.9901.14ANI	258	03.9940.EQ	280
03.9446.14ADA	252	03.9476.14ACB	256	03.9635.14BDA	102	03.9764.14ACB	263	03.9901.40A	258	03.9940.ER	280
03.9446.14ANI	252	03.9476.14ADA	256	03.9635.40A	102	03.9764.14ADA	263	03.9901.40ACB	258	03.9940.ES	280
03.9446.40A	252	03.9476.14ANI	256	03.9635.40ACB	102	03.9764.40A	263	03.9901.40ADA	258	03.9941.14	280
03.9446.40ACB	252	03.9476.40A	256	03.9635.40BDA	102	03.9764.40ACB	263	03.9901.40ANI	258	03.9941.40	280
03.9446.40ADA	252	03.9476.40ACB	256	03.9636.14A	102	03.9764.40ADA	263	03.9902.14A	258	03.9941.EQ	280
03.9446.40ANI	252	03.9476.40ADA	256	03.9636.14ACB	102	03.9765.14A	263	03.9902.14ACB	258	03.9941.ER	280
03.9450.14A	251	03.9476.40ANI	256	03.9636.14BDA	102	03.9765.14ACB	263	03.9902.14ADA	258	03.9941.ES	280
03.9450.14ACB	251	03.9500.02	578	03.9636.40A	102	03.9765.14ADA	263	03.9902.14ANI	258	03.9942.14	280
03.9450.14ADA	251	03.9500.14	578	03.9636.40ACB	102	03.9765.40A	263	03.9902.40A	258	03.9942.40	280
03.9450.14ANI	251	03.9500.40	578	03.9636.40BDA	102	03.9765.40ACB	263	03.9902.40ACB	258	03.9942.EQ	280
03.9450.40A	251	03.9500.ET	578	03.9660.14A	103	03.9765.40ADA	263	03.9902.40ADA	258	03.9942.ER	280
03.9450.40ACB	251	03.9500.EU	578	03.9660.14ACB	103	03.9820.14A	261	03.9902.40ANI	258	03.9942.ES	280
03.9450.40ADA	251	03.9501.02	578	03.9660.14BDA	103	03.9820.14ACB	261	03.9903.14A	258	03.9943.14	280
03.9450.40ANI	251	03.9501.14	578	03.9660.40A	103	03.9820.14ADA	261	03.9903.14ACB	258	03.9943.40	280
03.9451.14A	251	03.9501.40	578	03.9660.40ACB	103	03.9820.40A	261	03.9903.14ADA	258	03.9943.EQ	280
03.9451.14ACB	251	03.9501.ET	578	03.9660.40BDA	103	03.9820.40ACB	261	03.9903.14ANI	258	03.9943.ER	280
03.9451.14ADA	251	03.9501.EU	578	03.9661.14A	103	03.9820.40ADA	261	03.9903.40A	258	03.9943.ES	280
03.9451.14ANI	251	03.9502.02	578	03.9661.14ACB	103	03.9821.14A	261	03.9903.40ACB	258	03.9950.14	276
03.9451.40A	251	03.9502.14	578	03.9661.14BDA	103	03.9821.14ACB	261	03.9903.40ADA	258	03.9950.40	276
03.9451.40ACB	251	03.9502.40	578	03.9661.40A	103	03.9821.14ADA	261	03.9903.40ANI	258	03.9950.EQ	276
03.9451.40ADA	251	03.9502.ET	578	03.9661.40ACB	103	03.9821.40A	261	03.9904.14A	104	03.9950.ER	276
03.9451.40ANI	251	03.9502.EU	578	03.9661.40BDA	103	03.9821.40ACB	261	03.9904.14ACB	104	03.9950.ES	276
03.9455.14A	252	03.9503.02	578	03.9664.14A	103	03.9821.40ADA	261	03.9904.14BDA	104	03.9951.14	276
03.9455.14ACB	252	03.9503.14	578	03.9664.14ACB	103	03.9825.14A	262	03.9904.40A	104	03.9951.40	276
03.9455.14ADA	252	03.9503.40	578	03.9664.14BDA	103	03.9825.14ACB	262	03.9904.40ACB	104	03.9951.EQ	276
03.9455.14ANI	252	03.9503.ET	578	03.9664.40A	103	03.9825.14ADA	262	03.9904.40BDA	104	03.9951.ER	276
03.9455.40A	252	03.9503.EU	578	03.9664.40ACB	103	03.9825.40A	262	03.9905.14A	104	03.9951.ES	276
03.9455.40ACB	252	03.9510.02	578	03.9664.40BDA	103	03.9825.40ACB	262	03.9905.14ACB	104	03.9952.14	276
03.9455.40ADA	252	03.9510.14	578	03.9665.14A	103	03.9825.40ADA	262	03.9905.14BDA	104	03.9952.40	276
03.9455.40ANI	252	03.9510.40	578	03.9665.14ACB	103	03.9826.14A	262	03.9905.40A	104	03.9952.EQ	276
03.9456.14A	252	03.9510.ET	578	03.9665.14BDA	103	03.9826.14ACB	262	03.9905.40ACB	104	03.9952.ER	276
03.9456.14ACB	252	03.9510.EU	578	03.9665.40A	103	03.9826.14ADA	262	03.9905.40BDA	104	03.9952.ES	276
03.9456.14ADA	252	03.9511.02	578	03.9665.40ACB	103	03.9826.40A	262	03.9910.14	276	03.9953.14	276
03.9456.14ANI	252	03.9511.14	578	03.9665.40BDA	103	03.9826.40ACB	262	03.9910.40	276	03.9953.40	276
03.9456.40A	252	03.9511.40	578	03.9720.14A	261	03.9826.40ADA	262	03.9910.EQ	276	03.9953.EQ	276
03.9456.40ACB	252	03.9511.ET	578	03.9720.14ACB	261	03.9830.14A	261	03.9910.ER	276	03.9953.ER	276
03.9456.40ADA	252	03.9511.EU	578	03.9720.14ADA	261	03.9830.14ACB	261	03.9910.ES	276	03.9953.ES	276
03.9456.40ANI	252	03.9560.02	579	03.9720.40A	261	03.9830.14ADA	261	03.9911.14	276	03.9954.14	276
03.9460.14A	255	03.9560.14	579	03.9720.40ACB	261	03.9830.40A	261	03.9911.40	276	03.9954.40	276
03.9460.14ACB	255	03.9560.40	579	03.9720.40ADA	261	03.9830.40ACB	261	03.9911.EQ	276	03.9954.EQ	276
03.9460.14ADA	255	03.9560.ET	579	03.9721.14A	261	03.9830.40ADA	261	03.9911.ER	276	03.9954.ER	276
03.9460.14ANI	255	03.9560.EU	579	03.9721.14ACB	261	03.9831.14A	261	03.9911.ES	276	03.9954.ES	276
03.9460.40A	255	03.9561.02	579	03.9721.14ADA	261	03.9831.14ACB	261	03.9912.14	276	03.9955.14	276
03.9460.40ACB	255	03.9561.14	579	03.9721.40A	261	03.9831.14ADA	261	03.9912.40	276	03.9955.40	276
03.9460.40ADA	255	03.9561.40	579	03.9721.40ACB	261	03.9831.40A	261	03.9912.EQ	276	03.9955.EQ	276
03.9460.40ANI	255	03.9561.ET	579	03.9721.40ADA	261	03.9831.40ACB	261	03.9912.ER	276	03.9955.ER	276
03.9461.14A	255	03.9561.EU	579	03.9725.14A	262	03.9831.40ADA	261	03.9912.ES	276	03.9955.ES	276
03.9461.14ACB	255	03.9570.02	579	03.9725.14ACB	262	03.9835.14A	262	03.9913.14	276	03.9956.14	276
03.9461.14ADA	255	03.9570.14	579	03.9725.14ADA	262	03.9835.14ACB	262	03.9913.40	276	03.9956.40	276
03.9461.14ANI	255	03.9570.40	579	03.9725.40A	262	03.9835.14ADA	262	03.9913.EQ	276	03.9956.EQ	276
03.9461.40A	255	03.9570.ET	579	03.9725.40ACB	262	03.9835.40A	262	03.9913.ER	276	03.9956.ER	276
03.9461.40ACB	255	03.9570.EU	579	03.9725.40ADA	262	03.9835.40ACB	262	03.9913.ES	276	03.9956.ES	276
03.9461.40ADA	255	03.9571.02	579	03.9726.14A	262	03.9835.40ADA	262	03.9920.14	278	03.9957.14	276
03.9461.40ANI	255	03.9571.14	579	03.9726.14ACB	262	03.9836.14A	262	03.9920.40	278	03.9957.40	276
03.9465.14A	256	03.9571.40	579	03.9726.14ADA	262	03.9836.14ACB	262	03.9920.EQ	278	03.9957.EQ	276
03.9465.14ACB	256	03.9571.ET	579	03.9726.40A	262	03.9836.14ADA	262	03.9920.ER	278	03.9957.ER	276
03.9465.14ADA	256	03.9571.EU	579	03.9726.40ACB	262	03.9836.40A	262	03.9920.ES	278	03.9957.ES	276
03.9465.14ANI	256	03.9620.14A	101	03.9726.40ADA	262	03.9836.40ACB	262	03.9921.14	278	03.9960.14	278
03.9465.40A	256	03.9620.14ACB	101	03.9730.14A	261	03.9836.40ADA	262	03.9921.40	278	03.9960.40	278
03.9465.40ACB	256	03.9620.14BDA	101	03.9730.14ACB	261	03.9860.14A	263	03.9921.EQ	278	03.9960.EQ	278
03.9465.40ADA	256	03.9620.40A	101	03.9730.14ADA	261	03.9860.14ACB	263	03.9921.ER	278	03.9960.ER	278
03.9465.40ANI	256	03.9620.40ACB	101	03.9730.40A	261	03.9860.14ADA	263	03.9921.ES	278	03.9960.ES	278
03.9466.14A	256	03.9620.40BDA	101	03.9730.40ACB	261	03.9860.40A	263	03.9922.14	278	03.9961.14	278
03.9466.14ACB	256	03.9621.14A	101	03.9730.40ADA	261	03.9860.40ACB	263	03.9922.40	278	03.9961.40	278
03.9466.14ADA	256	03.9621.14ACB	101	03.9731.14A	261	03.9860.40ADA	263	03.9922.EQ	278	03.9961.EQ	278
03.9466.14ANI	256	03.9621.14BDA	101	03.9731.14ACB	261	03.9861.14A	263	03.9922.ER	278	03.9961.ER	278
03.9466.40A	256	03.9621.40A	101	03.9731.14ADA	261	03.9861.14ACB	263	03.9922.ES	278	03.9961.ES	278
03.9466.40ACB	256	03.9621.40ACB	101	03.9731.40A	261	03.9861.14ADA	263	03.9923.14	279	03.9962.14	278
03.9466.40ADA	256	03.9621.40BDA	101	03.9731.40ACB	261	03.9861.40A	263	03.9923.40	279	03.9962.40	278
03.9466.40ANI	256	03.9625.14A	102	03.9731.40ACB	261	03.9861.40ACB	263	03.9923.EQ	279	03.9962.EQ	278
03.9470.14A	255	03.9625.14ACB	102	03.9735.14A	262	03.9861.40ADA	263	03.9923.ER	279	03.9962.ER	278
03.9470.14ACB	255	03.9625.14BDA	102	03.9735.14ACB	262	03.9864.14A	263	03.9923.ES	279	03.9962.ES	278
03.9470.14ADA	255	03.9625.40A	102	03.9735.14ADA	262	03.9864.14ACB	263	03.9924.14	278	03.9963.14	279
03.9470.14ANI	255	03.9625.40ACB	102	03.9735.40A	262	03.9864.14ADA	263	03.9924.40	278	03.9963.40	279
03.9470.40A	255	03.9625.40BDA	102	03.9735.40ACB	262	03.9864.40A	263	03.9924.EQ	278	03.9963.EQ	279
03.9470.40ACB	255	03.9626.14A	102	03.9735.40ADA	262	03.9864.40ACB	263	03.9924.ER	278	03.9963.ER	279
03.9470.40ADA	255	03.9626.14ACB	102	03.9736.14A	262	03.9864.40ADA	263	03.9924.ES	278	03.9963.ES	279
03.9470.40ANI	255	03.9626.14BDA	102	03.9736.14ACB	262	03.9865.14A	263	03.9931.14A	277	03.9964.14	278
03.9471.14A	255	03.9626.40A	102	03.9736.14ADA	262	03.9865.14ACB	263	03.9931.40A	277	03.9964.40	278
03.9471.14ACB	255	03.9626.40ACB	102	03.9736.40A	262	03.9865.14ADA	263	03.9931.EQA	277	03.9964.EQ	278
03.9471.14ADA	255	03.9626.40BDA	102	03.9736.40ACB	262	03.9865.40A	263	03.9931.ERA	277	03.9964.ER	278
03.9471.14ANI	255	03.9630.14A	101	03.9736.40ADA	262	03.9865.40ACB	263	03.9931.ESA	277	03.9964.ES	278
03.9471.4											

QUICK SEARCH OF PRODUCT

Ref.	Page	Ref.	Page	Ref.	Page	Ref.	Page	Ref.	Page	Ref.	Page
03.9967.EQ	279	04.6021.08	476	05.0601.40	194	05.0613.14.NI	195	05.0625.14.DA	196	05.0637.14.CB	197
03.9967.ER	279	04.6021.08.NT	476	05.0601.40.CB	194	05.0613.40	195	05.0625.14.NI	196	05.0637.14.DA	197
03.9967.ES	279	04.6021.14	476	05.0601.40.DA	194	05.0613.40.CB	195	05.0625.40	196	05.0637.14.NI	197
03.9968.14	278	04.6021.14.NT	476	05.0601.40.NI	194	05.0613.40.DA	195	05.0625.40.CB	196	05.0637.40	197
03.9968.40	278	04.6021.20	476	05.0602.14	194	05.0613.40.NI	195	05.0625.40.DA	196	05.0637.40.CB	197
03.9968.EQ	278	04.6021.20.NT	476	05.0602.14.CB	194	05.0614.14	195	05.0625.40.NI	196	05.0637.40.DA	197
03.9968.ER	278	04.6022.08	476	05.0602.14.DA	194	05.0614.14.CB	195	05.0626.14	196	05.0637.40.NI	197
03.9968.ES	278	04.6022.08.NT	476	05.0602.14.NI	194	05.0614.14.DA	195	05.0626.14.CB	196	05.0638.14	197
03.9969.14	278	04.6022.14	476	05.0602.40	194	05.0614.14.NI	195	05.0626.14.DA	196	05.0638.14.CB	197
03.9969.40	278	04.6022.14.NT	476	05.0602.40.CB	194	05.0614.40	195	05.0626.14.NI	196	05.0638.14.DA	197
03.9969.EQ	278	04.6022.20	476	05.0602.40.DA	194	05.0614.40.CB	195	05.0626.40	196	05.0638.14.NI	197
03.9969.ER	278	04.6022.20.NT	476	05.0602.40.NI	194	05.0614.40.DA	195	05.0626.40.CB	196	05.0638.40	197
03.9969.ES	278	04.6300.08	481	05.0603.14	194	05.0614.40.NI	195	05.0626.40.DA	196	05.0638.40.CB	197
03.9971.14A	277	04.6300.14	481	05.0603.14.CB	194	05.0615.14	195	05.0626.40.NI	196	05.0638.40.DA	197
03.9971.40A	277	04.6300.20	481	05.0603.14.DA	194	05.0615.14.CB	195	05.0627.14	196	05.0638.40.NI	197
03.9971.EQA	277	04.6301.08	482	05.0603.14.NI	194	05.0615.14.DA	195	05.0627.14.CB	196	05.0639.14	197
03.9971.ERA	277	04.6301.14	482	05.0603.40	194	05.0615.14.NI	195	05.0627.14.DA	196	05.0639.14.CB	197
03.9971.ESA	277	04.6301.20	482	05.0603.40.CB	194	05.0615.40	195	05.0627.14.NI	196	05.0639.14.DA	197
03.9972.14A	277	04.6302.08	483	05.0603.40.DA	194	05.0615.40.CB	195	05.0627.40	196	05.0639.14.NI	197
03.9972.40A	277	04.6302.14	483	05.0603.40.NI	194	05.0615.40.DA	195	05.0627.40.CB	196	05.0639.40	197
03.9972.EQA	277	04.6302.20	483	05.0604.14	194	05.0615.40.NI	195	05.0627.40.DA	196	05.0639.40.CB	197
03.9972.ERA	277	04.6305.08	481	05.0604.14.CB	194	05.0616.14	195	05.0627.40.NI	196	05.0639.40.DA	197
03.9972.ESA	277	04.6305.14	481	05.0604.14.DA	194	05.0616.14.CB	195	05.0628.14	196	05.0639.40.NI	197
03.9973.14A	277	04.6305.20	481	05.0604.14.NI	194	05.0616.14.DA	195	05.0628.14.CB	196	05.0640.14	214
03.9973.40A	277	04.6306.08	482	05.0604.40	194	05.0616.14.NI	195	05.0628.14.DA	196	05.0640.14.CB	214
03.9973.EQA	277	04.6306.14	482	05.0604.40.CB	194	05.0616.40	195	05.0628.14.NI	196	05.0640.14.DA	214
03.9973.ERA	277	04.6306.20	482	05.0604.40.DA	194	05.0616.40.CB	195	05.0628.40	196	05.0640.14.NI	214
03.9973.ESA	277	04.6307.08	483	05.0604.40.NI	194	05.0616.40.DA	195	05.0628.40.CB	196	05.0640.40	214
03.9976.14A	277	04.6307.14	483	05.0605.14	194	05.0616.40.NI	195	05.0628.40.DA	196	05.0640.40.CB	214
03.9976.40A	277	04.6307.20	483	05.0605.14.CB	194	05.0617.14	195	05.0628.40.NI	196	05.0640.40.DA	214
03.9976.EQA	277	04.6330.08B	481	05.0605.14.DA	194	05.0617.14.CB	195	05.0629.14	196	05.0640.40.NI	214
03.9976.ERA	277	04.6330.14B	481	05.0605.14.NI	194	05.0617.14.DA	195	05.0629.14.CB	196	05.0641.14	214
03.9976.ESA	277	04.6330.20B	481	05.0605.40	194	05.0617.14.NI	195	05.0629.14.DA	196	05.0641.14.CB	214
03.9977.14A	277	04.6333.08B	482	05.0605.40.CB	194	05.0617.40	195	05.0629.14.NI	196	05.0641.14.DA	214
03.9977.40A	277	04.6333.14B	482	05.0605.40.DA	194	05.0617.40.CB	195	05.0629.40	196	05.0641.14.NI	214
03.9977.EQA	277	04.6333.20B	482	05.0605.40.NI	194	05.0617.40.DA	195	05.0629.40.CB	196	05.0641.40	214
03.9977.ERA	277	04.6334.08B	482	05.0606.14	194	05.0617.40.NI	195	05.0629.40.DA	196	05.0641.40.CB	214
03.9977.ESA	277	04.6334.14B	482	05.0606.14.CB	194	05.0618.14	195	05.0629.40.NI	196	05.0641.40.DA	214
03.9978.14A	277	04.6334.20B	482	05.0606.14.DA	194	05.0618.14.CB	195	05.0630.14	197	05.0641.40.NI	214
03.9978.40A	277	04.6335.08B	482	05.0606.14.NI	194	05.0618.14.DA	195	05.0630.14.CB	197	05.0642.14	214
03.9978.EQA	277	04.6335.14B	482	05.0606.40	194	05.0618.14.NI	195	05.0630.14.DA	197	05.0642.14.CB	214
03.9978.ERA	277	04.6335.20B	482	05.0606.40.CB	194	05.0618.40	195	05.0630.14.NI	197	05.0642.14.DA	214
03.9978.ESA	277	04.6336.08B	483	05.0606.40.DA	194	05.0618.40.CB	195	05.0630.40	197	05.0642.14.NI	214
03.9980.14	280	04.6336.14B	483	05.0606.40.NI	194	05.0618.40.DA	195	05.0630.40.CB	197	05.0642.40	214
03.9980.40	280	04.6336.20B	483	05.0607.14	194	05.0618.40.NI	195	05.0630.40.DA	197	05.0642.40.CB	214
03.9980.EQ	280	04.6337.08B	483	05.0607.14.CB	194	05.0619.14	195	05.0630.40.NI	197	05.0642.40.DA	214
03.9980.ER	280	04.6337.14B	483	05.0607.14.DA	194	05.0619.14.CB	195	05.0631.14	197	05.0642.40.NI	214
03.9980.ES	280	04.6337.20B	483	05.0607.14.NI	194	05.0619.14.DA	195	05.0631.14.CB	197	05.0643.14	214
03.9981.14	280	04.6338.08B	483	05.0607.40	194	05.0619.14.NI	195	05.0631.14.DA	197	05.0643.14.CB	214
03.9981.40	280	04.6338.14B	483	05.0607.40.CB	194	05.0619.40	195	05.0631.14.NI	197	05.0643.14.DA	214
03.9981.EQ	280	04.6338.20B	483	05.0607.40.DA	194	05.0619.40.CB	195	05.0631.40	197	05.0643.14.NI	214
03.9981.ER	280	04.6470.08B	474	05.0607.40.NI	194	05.0619.40.DA	195	05.0631.40.CB	197	05.0643.40	214
03.9981.ES	280	04.6470.14B	474	05.0608.14	194	05.0619.40.NI	195	05.0631.40.DA	197	05.0643.40.CB	214
03.9982.14	280	04.6470.14BNT	474	05.0608.14.CB	194	05.0620.14	196	05.0631.40.NI	197	05.0643.40.DA	214
03.9982.40	280	04.6470.20B	474	05.0608.14.DA	194	05.0620.14.CB	196	05.0632.14	197	05.0643.40.NI	214
03.9982.EQ	280	04.6471.08B	474	05.0608.14.NI	194	05.0620.14.DA	196	05.0632.14.CB	197	05.0644.14	214
03.9982.ER	280	04.6471.14B	474	05.0608.40	194	05.0620.14.NI	196	05.0632.14.DA	197	05.0644.14.CB	214
03.9982.ES	280	04.6471.14BNT	474	05.0608.40.CB	194	05.0620.40	196	05.0632.14.NI	197	05.0644.14.DA	214
03.9983.14	280	04.6471.20B	474	05.0608.40.DA	194	05.0620.40.CB	196	05.0632.40	197	05.0644.14.NI	214
03.9983.40	280	04.6475.08B	474	05.0608.40.NI	194	05.0620.40.DA	196	05.0632.40.CB	197	05.0644.40	214
03.9983.EQ	280	04.6475.14B	474	05.0609.14	194	05.0620.40.NI	196	05.0632.40.DA	197	05.0644.40.CB	214
03.9983.ER	280	04.6475.14BNT	474	05.0609.14.CB	194	05.0621.14	196	05.0632.40.NI	197	05.0644.40.DA	214
03.9983.ES	280	04.6475.20B	474	05.0609.14.DA	194	05.0621.14.CB	196	05.0633.14	197	05.0644.40.NI	214
03.9985.14	280	04.6476.08B	474	05.0609.14.NI	194	05.0621.14.DA	196	05.0633.14.CB	197	05.0645.14	214
03.9985.40	280	04.6476.14B	474	05.0609.40	194	05.0621.14.NI	196	05.0633.14.DA	197	05.0645.14.CB	214
03.9985.EQ	280	04.6476.14BNT	474	05.0609.40.CB	194	05.0621.40	196	05.0633.14.NI	197	05.0645.14.DA	214
03.9985.ER	280	04.6476.20B	474	05.0609.40.DA	194	05.0621.40.CB	196	05.0633.40	197	05.0645.14.NI	214
03.9985.ES	280	04.6480.08B	475	05.0609.40.NI	194	05.0621.40.DA	196	05.0633.40.CB	197	05.0645.40	214
03.9986.14	280	04.6480.14B	475	05.0610.14	195	05.0621.40.NI	196	05.0633.40.DA	197	05.0645.40.CB	214
03.9986.40	280	04.6480.14BNT	475	05.0610.14.CB	195	05.0622.14	196	05.0633.40.NI	197	05.0645.40.DA	214
03.9986.EQ	280	04.6480.20B	475	05.0610.14.DA	195	05.0622.14.CB	196	05.0634.14	197	05.0645.40.NI	214
03.9986.ER	280	04.6481.08B	475	05.0610.14.NI	195	05.0622.14.DA	196	05.0634.14.CB	197	05.0646.14	214
03.9986.ES	280	04.6481.14B	475	05.0610.40	195	05.0622.14.NI	196	05.0634.14.DA	197	05.0646.14.CB	214
03.9987.14	280	04.6481.14BNT	475	05.0610.40.CB	195	05.0622.40	196	05.0634.14.NI	197	05.0646.14.DA	214
03.9987.40	280	04.6481.20B	475	05.0610.40.DA	195	05.0622.40.CB	196	05.0634.40	197	05.0646.14.NI	214
03.9987.EQ	280	04.6485.08B	475	05.0610.40.NI	195	05.0622.40.DA	196	05.0634.40.CB	197	05.0646.40	214
03.9987.ER	280	04.6485.14B	475	05.0611.14	195	05.0622.40.NI	196	05.0634.40.DA	197	05.0646.40.CB	214
03.9987.ES	280	04.6485.14BNT	475	05.0611.14.CB	195	05.0623.14	196	05.0634.40.NI	197	05.0646.40.DA	214
03.9988.14	280	04.6485.20B	475	05.0611.14.DA	195	05.0623.14.CB	196	05.0635.14	197	05.0646.40.NI	214
03.9988.40	280	04.6486.08B	475	05.0611.14.NI	195	05.0623.14.DA	196	05.0635.14.CB	197	05.0647.14	214
03.9988.EQ	280	04.6486.14B	475	05.0611.40	195	05.0623.14.NI	196	05.0635.14.DA	197	05.0647.14.CB	214
03.9988.ER	280	04.6486.14BNT	475	05.0611.40.CB	195	05.0623.40	196				

QUICK SEARCH OF PRODUCT

Ref.	Page	Ref.	Page	Ref.	Page	Ref.	Page	Ref.	Page	Ref.	Page
05.0649.14	214	05.0660.40.NI	216	05.0672.40.DA	217	05.0710.14.DA	265	05.0736.14	267	05.0761.40.NI	266
05.0649.14.CB	214	05.0661.14	216	05.0672.40.NI	217	05.0710.14.NI	265	05.0736.14.DA	267	05.0762.14	266
05.0649.14.DA	214	05.0661.14.CB	216	05.0673.14	217	05.0710.40	265	05.0736.14.NI	267	05.0762.14.DA	266
05.0649.14.NI	214	05.0661.14.DA	216	05.0673.14.CB	217	05.0710.40.DA	265	05.0736.40	267	05.0762.14.NI	266
05.0649.40	214	05.0661.14.NI	216	05.0673.14.DA	217	05.0710.40.NI	265	05.0736.40.DA	267	05.0763.14	266
05.0649.40.CB	214	05.0661.40	216	05.0673.14.NI	217	05.0711.14	265	05.0736.40.NI	267	05.0763.14.DA	266
05.0649.40.DA	214	05.0661.40.CB	216	05.0673.40	217	05.0711.14.DA	265	05.0737.40	267	05.0763.14.NI	266
05.0649.40.NI	214	05.0661.40.DA	216	05.0673.40.CB	217	05.0711.14.NI	265	05.0737.40.DA	267	05.0765.14	266
05.0650.14	215	05.0661.40.NI	216	05.0673.40.DA	217	05.0711.40	265	05.0737.40.NI	267	05.0765.14.DA	266
05.0650.14.CB	215	05.0662.14	216	05.0673.40.NI	217	05.0711.40.DA	265	05.0738.40	267	05.0765.14.NI	266
05.0650.14.DA	215	05.0662.14.CB	216	05.0674.14	217	05.0711.40.NI	265	05.0738.40.DA	267	05.0765.40	266
05.0650.14.NI	215	05.0662.14.DA	216	05.0674.14.CB	217	05.0712.40	265	05.0738.40.NI	267	05.0765.40.DA	266
05.0650.40	215	05.0662.14.NI	216	05.0674.14.DA	217	05.0712.40.DA	265	05.0740.14	264	05.0765.40.NI	266
05.0650.40.CB	215	05.0662.40	216	05.0674.14.NI	217	05.0712.40.NI	265	05.0740.14.DA	264	05.0766.14	266
05.0650.40.DA	215	05.0662.40.CB	216	05.0674.40	217	05.0713.40	265	05.0740.14.NI	264	05.0766.14.DA	266
05.0650.40.NI	215	05.0662.40.DA	216	05.0674.40.CB	217	05.0713.40.DA	265	05.0740.40	264	05.0766.14.NI	266
05.0651.14	215	05.0662.40.NI	216	05.0674.40.DA	217	05.0713.40.NI	265	05.0740.40.DA	264	05.0766.40	266
05.0651.14.CB	215	05.0663.14	216	05.0674.40.NI	217	05.0715.14	265	05.0740.40.NI	264	05.0766.40.DA	266
05.0651.14.DA	215	05.0663.14.CB	216	05.0675.14	217	05.0715.14.DA	265	05.0741.14	264	05.0766.40.NI	266
05.0651.14.NI	215	05.0663.14.DA	216	05.0675.14.CB	217	05.0715.14.NI	265	05.0741.14.DA	264	05.0767.14	266
05.0651.40	215	05.0663.14.NI	216	05.0675.14.DA	217	05.0715.40	265	05.0741.14.NI	264	05.0767.14.DA	266
05.0651.40.CB	215	05.0663.40	216	05.0675.14.NI	217	05.0715.40.DA	265	05.0741.40	264	05.0767.14.NI	266
05.0651.40.DA	215	05.0663.40.CB	216	05.0675.40	217	05.0715.40.NI	265	05.0741.40.DA	264	05.0768.14	266
05.0651.40.NI	215	05.0663.40.DA	216	05.0675.40.CB	217	05.0716.14	265	05.0741.40.NI	264	05.0768.14.DA	266
05.0652.14	215	05.0663.40.NI	216	05.0675.40.DA	217	05.0716.14.DA	265	05.0742.14	264	05.0768.14.NI	266
05.0652.14.CB	215	05.0664.14	216	05.0675.40.NI	217	05.0716.14.NI	265	05.0742.14.DA	264	05.0770.14	267
05.0652.14.DA	215	05.0664.14.CB	216	05.0676.14	217	05.0716.40	265	05.0742.14.NI	264	05.0770.14.DA	267
05.0652.14.NI	215	05.0664.14.DA	216	05.0676.14.CB	217	05.0716.40.DA	265	05.0743.14	264	05.0770.14.NI	267
05.0652.40	215	05.0664.14.NI	216	05.0676.14.DA	217	05.0716.40.NI	265	05.0743.14.DA	264	05.0770.40	267
05.0652.40.CB	215	05.0664.40	216	05.0676.14.NI	217	05.0717.40	265	05.0743.14.NI	264	05.0770.40.DA	267
05.0652.40.DA	215	05.0664.40.CB	216	05.0676.40	217	05.0717.40.DA	265	05.0745.14	264	05.0770.40.NI	267
05.0652.40.NI	215	05.0664.40.DA	216	05.0676.40.CB	217	05.0717.40.NI	265	05.0745.14.DA	264	05.0771.14	267
05.0653.14	215	05.0664.40.NI	216	05.0676.40.DA	217	05.0718.40	265	05.0745.14.NI	264	05.0771.14.DA	267
05.0653.14.CB	215	05.0665.14	216	05.0676.40.NI	217	05.0718.40.DA	265	05.0745.40	264	05.0771.14.NI	267
05.0653.14.DA	215	05.0665.14.CB	216	05.0677.14	217	05.0718.40.NI	265	05.0745.40.DA	264	05.0771.40	267
05.0653.14.NI	215	05.0665.14.DA	216	05.0677.14.CB	217	05.0720.14	266	05.0745.40.NI	264	05.0771.40.DA	267
05.0653.40	215	05.0665.14.NI	216	05.0677.14.DA	217	05.0720.14.DA	266	05.0746.14	264	05.0771.40.NI	267
05.0653.40.CB	215	05.0665.40	216	05.0677.14.NI	217	05.0720.14.NI	266	05.0746.14.DA	264	05.0772.14	267
05.0653.40.DA	215	05.0665.40.CB	216	05.0677.40	217	05.0720.40	266	05.0746.14.NI	264	05.0772.14.DA	267
05.0653.40.NI	215	05.0665.40.DA	216	05.0677.40.CB	217	05.0720.40.DA	266	05.0746.40	264	05.0772.14.NI	267
05.0654.14	215	05.0665.40.NI	216	05.0677.40.DA	217	05.0720.40.NI	266	05.0746.40.DA	264	05.0773.14	267
05.0654.14.CB	215	05.0666.14	216	05.0677.40.NI	217	05.0721.14	266	05.0746.40.NI	264	05.0773.14.DA	267
05.0654.14.DA	215	05.0666.14.CB	216	05.0678.14	217	05.0721.14.DA	266	05.0747.14	264	05.0773.14.NI	267
05.0654.14.NI	215	05.0666.14.DA	216	05.0678.14.CB	217	05.0721.14.NI	266	05.0747.14.DA	264	05.0775.14	267
05.0654.40	215	05.0666.14.NI	216	05.0678.14.DA	217	05.0721.40	266	05.0747.14.NI	264	05.0775.14.DA	267
05.0654.40.CB	215	05.0666.40	216	05.0678.14.NI	217	05.0721.40.DA	266	05.0748.14	264	05.0775.14.NI	267
05.0654.40.DA	215	05.0666.40.CB	216	05.0678.40	217	05.0721.40.NI	266	05.0748.14.DA	264	05.0775.40	267
05.0654.40.NI	215	05.0666.40.DA	216	05.0678.40.CB	217	05.0722.40	266	05.0748.14.NI	264	05.0775.40.DA	267
05.0655.14	215	05.0666.40.NI	216	05.0678.40.DA	217	05.0722.40.DA	266	05.0750.14	265	05.0775.40.NI	267
05.0655.14.CB	215	05.0667.14	216	05.0678.40.NI	217	05.0722.40.NI	266	05.0750.14.DA	265	05.0776.14	267
05.0655.14.DA	215	05.0667.14.CB	216	05.0679.14	217	05.0723.40	266	05.0750.14.NI	265	05.0776.14.DA	267
05.0655.14.NI	215	05.0667.14.DA	216	05.0679.14.CB	217	05.0723.40.DA	266	05.0750.40	265	05.0776.14.NI	267
05.0655.40	215	05.0667.14.NI	216	05.0679.14.DA	217	05.0723.40.NI	266	05.0750.40.DA	265	05.0776.40	267
05.0655.40.CB	215	05.0667.40	216	05.0679.14.NI	217	05.0725.14	266	05.0750.40.NI	265	05.0776.40.DA	267
05.0655.40.DA	215	05.0667.40.CB	216	05.0679.40	217	05.0725.14.DA	266	05.0751.14	265	05.0776.40.NI	267
05.0655.40.NI	215	05.0667.40.DA	216	05.0679.40.CB	217	05.0725.14.NI	266	05.0751.14.DA	265	05.0777.14	267
05.0656.14	215	05.0667.40.NI	216	05.0679.40.DA	217	05.0725.40	266	05.0751.14.NI	265	05.0777.14.DA	267
05.0656.14.CB	215	05.0668.14	216	05.0679.40.NI	217	05.0725.40.DA	266	05.0751.40	265	05.0777.14.NI	267
05.0656.14.DA	215	05.0668.14.CB	216	05.0700.14	264	05.0725.40.NI	266	05.0751.40.DA	265	05.0778.14	267
05.0656.14.NI	215	05.0668.14.DA	216	05.0700.14.DA	264	05.0726.14	266	05.0751.40.NI	265	05.0778.14.DA	267
05.0656.40	215	05.0668.14.NI	216	05.0700.14.NI	264	05.0726.14.DA	266	05.0752.14	265	05.0778.14.NI	267
05.0656.40.CB	215	05.0668.40	216	05.0700.40	264	05.0726.14.NI	266	05.0752.14.DA	265	05.0800.14	264
05.0656.40.DA	215	05.0668.40.CB	216	05.0700.40.DA	264	05.0726.40	266	05.0752.14.NI	265	05.0800.14.DA	264
05.0656.40.NI	215	05.0668.40.DA	216	05.0700.40.NI	264	05.0726.40.DA	266	05.0753.14	265	05.0800.14.NI	264
05.0657.14	215	05.0668.40.NI	216	05.0701.14	264	05.0726.40.NI	266	05.0753.14.DA	265	05.0801.14	264
05.0657.14.CB	215	05.0669.14	216	05.0701.14.DA	264	05.0727.40	266	05.0753.14.NI	265	05.0801.14.DA	264
05.0657.14.DA	215	05.0669.14.CB	216	05.0701.14.NI	264	05.0727.40.DA	266	05.0755.14	265	05.0801.14.NI	264
05.0657.14.NI	215	05.0669.14.DA	216	05.0701.40	264	05.0727.40.NI	266	05.0755.14.DA	265	05.0805.14	264
05.0657.40	215	05.0669.14.NI	216	05.0701.40.DA	264	05.0728.40	266	05.0755.14.NI	265	05.0805.14.DA	264
05.0657.40.CB	215	05.0669.40	216	05.0701.40.NI	264	05.0728.40.DA	266	05.0755.40	265	05.0805.14.NI	264
05.0657.40.DA	215	05.0669.40.CB	216	05.0702.40	264	05.0728.40.NI	266	05.0755.40.DA	265	05.0806.14	264
05.0657.40.NI	215	05.0669.40.DA	216	05.0702.40.DA	264	05.0730.14	267	05.0755.40.NI	265	05.0806.14.DA	264
05.0658.14	215	05.0669.40.NI	216	05.0702.40.NI	264	05.0730.14.DA	267	05.0756.14	265	05.0806.14.NI	264
05.0658.14.CB	215	05.0670.14	217	05.0703.40	264	05.0730.14.NI	267	05.0756.14.DA	265	05.0810.14	265
05.0658.14.DA	215	05.0670.14.CB	217	05.0703.40.DA	264	05.0730.40	267	05.0756.14.NI	265	05.0810.14.DA	265
05.0658.14.NI	215	05.0670.14.DA	217	05.0703.40.NI	264	05.0730.40.DA	267	05.0756.40	265	05.0810.14.NI	265
05.0658.40	215	05.0670.14.NI	217	05.0705.14	264	05.0730.40.NI	267	05.0756.40.DA	265	05.0811.14	265
05.0658.40.CB	215	05.0670.40	217	05.0705.14.DA	264	05.0731.14	267	05.0756.40.NI	265	05.0811.14.DA	265
05.0658.40.DA	215	05.0670.40.CB	217	05.0705.14.NI	264	05.0731.14.DA	267	05.0757.14	265	05.0811.14.NI	265
05.0658.40.NI	215	05.0670.40.DA	217	05.0705.40	264	05.0731.14.NI	267	05.0757.14.DA	265	05.0815.14	265
05.0659.14	215	05.0670.40.NI	217	05.0705.40.DA	264	05.07					

QUICK SEARCH OF PRODUCT

Ref.	Page	Ref.	Page	Ref.	Page	Ref.	Page	Ref.	Page	Ref.	Page
05.0826.14.DA	266	05.0926.14	266	05.1006.14A	186	05.1025.40ANI	188	05.1045.40ADA	206	05.1065.40ACB	208
05.0826.14.NI	266	05.0926.14.DA	266	05.1006.14ACB	186	05.1026.14A	188	05.1045.40ANI	206	05.1065.40ADA	208
05.0830.14	267	05.0926.14.NI	266	05.1006.14ADA	186	05.1026.14ACB	188	05.1046.14A	206	05.1065.40ANI	208
05.0830.14.DA	267	05.0930.14	267	05.1006.14ANI	186	05.1026.14ADA	188	05.1046.14ACB	206	05.1066.14A	208
05.0830.14.NI	267	05.0930.14.DA	267	05.1006.40A	186	05.1026.14ANI	188	05.1046.14ADA	206	05.1066.14ACB	208
05.0831.14	267	05.0930.14.NI	267	05.1006.40ACB	186	05.1026.40A	188	05.1046.14ANI	206	05.1066.14ADA	208
05.0831.14.DA	267	05.0931.14	267	05.1006.40ADA	186	05.1026.40ACB	188	05.1046.40A	206	05.1066.14ANI	208
05.0831.14.NI	267	05.0931.14.DA	267	05.1006.40ANI	186	05.1026.40ADA	188	05.1046.40ACB	206	05.1066.40A	208
05.0835.14	267	05.0931.14.NI	267	05.1007.14A	186	05.1026.40ANI	188	05.1046.40ADA	206	05.1066.40ACB	208
05.0835.14.DA	267	05.0935.14	267	05.1007.14ACB	186	05.1027.14A	188	05.1046.40ANI	206	05.1066.40ADA	208
05.0835.14.NI	267	05.0935.14.DA	267	05.1007.14ADA	186	05.1027.14ACB	188	05.1047.14A	206	05.1066.40ANI	208
05.0836.14	267	05.0935.14.NI	267	05.1007.14ANI	186	05.1027.14ADA	188	05.1047.14ACB	206	05.1067.14A	208
05.0836.14.DA	267	05.0936.14	267	05.1007.40A	186	05.1027.14ANI	188	05.1047.14ADA	206	05.1067.14ACB	208
05.0836.14.NI	267	05.0936.14.DA	267	05.1007.40ACB	186	05.1027.40A	188	05.1047.14ANI	206	05.1067.14ADA	208
05.0840.14	264	05.0936.14.NI	267	05.1007.40ADA	186	05.1027.40ACB	188	05.1047.40A	206	05.1067.14ANI	208
05.0840.14.DA	264	05.0940.14	264	05.1007.40ANI	186	05.1027.40ADA	188	05.1047.40ACB	206	05.1067.40A	208
05.0840.14.NI	264	05.0940.14.DA	264	05.1010.14A	187	05.1027.40ANI	188	05.1047.40ADA	206	05.1067.40ACB	208
05.0841.14	264	05.0940.14.NI	264	05.1010.14ACB	187	05.1030.14A	189	05.1047.40ANI	206	05.1067.40ADA	208
05.0841.14.DA	264	05.0941.14	264	05.1010.14ADA	187	05.1030.14ACB	189	05.1050.14A	207	05.1067.40ANI	208
05.0841.14.NI	264	05.0941.14.DA	264	05.1010.14ANI	187	05.1030.14ADA	189	05.1050.14ACB	207	05.1070.14A	209
05.0845.14	264	05.0941.14.NI	264	05.1010.40A	187	05.1030.14ANI	189	05.1050.14ADA	207	05.1070.14ACB	209
05.0845.14.DA	264	05.0945.14	264	05.1010.40ACB	187	05.1030.40A	189	05.1050.14ANI	207	05.1070.14ADA	209
05.0845.14.NI	264	05.0945.14.DA	264	05.1010.40ADA	187	05.1030.40ACB	189	05.1050.40A	207	05.1070.14ANI	209
05.0846.14	264	05.0945.14.NI	264	05.1010.40ANI	187	05.1030.40ADA	189	05.1050.40ACB	207	05.1070.40A	209
05.0846.14.DA	264	05.0946.14	264	05.1011.14A	187	05.1030.40ANI	189	05.1050.40ADA	207	05.1070.40ACB	209
05.0846.14.NI	264	05.0946.14.DA	264	05.1011.14ACB	187	05.1031.14A	189	05.1050.40ANI	207	05.1070.40ADA	209
05.0850.14	265	05.0946.14.NI	264	05.1011.14ADA	187	05.1031.14ACB	189	05.1051.14A	207	05.1070.40ANI	209
05.0850.14.DA	265	05.0950.14	265	05.1011.14ANI	187	05.1031.14ADA	189	05.1051.14ACB	207	05.1071.14A	209
05.0850.14.NI	265	05.0950.14.DA	265	05.1011.40A	187	05.1031.14ANI	189	05.1051.14ADA	207	05.1071.14ACB	209
05.0851.14	265	05.0950.14.NI	265	05.1011.40ACB	187	05.1031.40A	189	05.1051.14ANI	207	05.1071.14ADA	209
05.0851.14.DA	265	05.0951.14	265	05.1011.40ADA	187	05.1031.40ACB	189	05.1051.40A	207	05.1071.14ANI	209
05.0851.14.NI	265	05.0951.14.DA	265	05.1011.40ANI	187	05.1031.40ADA	189	05.1051.40ACB	207	05.1071.40A	209
05.0855.14	265	05.0951.14.NI	265	05.1012.14A	187	05.1031.40ANI	189	05.1051.40ADA	207	05.1071.40ACB	209
05.0855.14.DA	265	05.0955.14	265	05.1012.14ACB	187	05.1032.14A	189	05.1051.40ANI	207	05.1071.40ADA	209
05.0855.14.NI	265	05.0955.14.DA	265	05.1012.14ADA	187	05.1032.14ACB	189	05.1052.14A	207	05.1071.40ANI	209
05.0856.14	265	05.0955.14.NI	265	05.1012.14ANI	187	05.1032.14ADA	189	05.1052.14ACB	207	05.1072.14A	209
05.0856.14.DA	265	05.0956.14	265	05.1012.40A	187	05.1032.14ANI	189	05.1052.14ADA	207	05.1072.14ACB	209
05.0856.14.NI	265	05.0956.14.DA	265	05.1012.40ACB	187	05.1032.40A	189	05.1052.14ANI	207	05.1072.14ADA	209
05.0860.14	266	05.0956.14.NI	265	05.1012.40ADA	187	05.1032.40ACB	189	05.1052.40A	207	05.1072.14ANI	209
05.0860.14.DA	266	05.0960.14	266	05.1012.40ANI	187	05.1032.40ADA	189	05.1052.40ACB	207	05.1072.40A	209
05.0860.14.NI	266	05.0960.14.DA	266	05.1015.14A	187	05.1032.40ANI	189	05.1052.40ADA	207	05.1072.40ACB	209
05.0861.14	266	05.0960.14.NI	266	05.1015.14ACB	187	05.1035.14A	189	05.1052.40ANI	207	05.1072.40ADA	209
05.0861.14.DA	266	05.0961.14	266	05.1015.14ADA	187	05.1035.14ACB	189	05.1055.14A	207	05.1072.40ANI	209
05.0861.14.NI	266	05.0961.14.DA	266	05.1015.14ANI	187	05.1035.14ADA	189	05.1055.14ACB	207	05.1075.14A	209
05.0865.14	266	05.0961.14.NI	266	05.1015.40A	187	05.1035.14ANI	189	05.1055.14ADA	207	05.1075.14ACB	209
05.0865.14.DA	266	05.0965.14	266	05.1015.40ACB	187	05.1035.40A	189	05.1055.14ANI	207	05.1075.14ADA	209
05.0865.14.NI	266	05.0965.14.DA	266	05.1015.40ADA	187	05.1035.40ACB	189	05.1055.40A	207	05.1075.14ANI	209
05.0866.14	266	05.0965.14.NI	266	05.1015.40ANI	187	05.1035.40ADA	189	05.1055.40ACB	207	05.1075.40A	209
05.0866.14.DA	266	05.0966.14	266	05.1016.14A	187	05.1035.40ANI	189	05.1055.40ADA	207	05.1075.40ACB	209
05.0866.14.NI	266	05.0966.14.DA	266	05.1016.14ACB	187	05.1036.14A	189	05.1055.40ANI	207	05.1075.40ADA	209
05.0870.14	267	05.0966.14.NI	266	05.1016.14ADA	187	05.1036.14ACB	189	05.1056.14A	207	05.1075.40ANI	209
05.0870.14.DA	267	05.0970.14	267	05.1016.14ANI	187	05.1036.14ADA	189	05.1056.14ACB	207	05.1076.14A	209
05.0870.14.NI	267	05.0970.14.DA	267	05.1016.40A	187	05.1036.14ANI	189	05.1056.14ADA	207	05.1076.14ACB	209
05.0871.14	267	05.0970.14.NI	267	05.1016.40ACB	187	05.1036.40A	189	05.1056.14ANI	207	05.1076.14ADA	209
05.0871.14.DA	267	05.0971.14	267	05.1016.40ADA	187	05.1036.40ACB	189	05.1056.40A	207	05.1076.14ANI	209
05.0871.14.NI	267	05.0971.14.DA	267	05.1016.40ANI	187	05.1036.40ADA	189	05.1056.40ACB	207	05.1076.40A	209
05.0875.14	267	05.0971.14.NI	267	05.1017.14A	187	05.1036.40ANI	189	05.1056.40ADA	207	05.1076.40ACB	209
05.0875.14.DA	267	05.0975.14	267	05.1017.14ACB	187	05.1037.14A	189	05.1056.40ANI	207	05.1076.40ADA	209
05.0875.14.NI	267	05.0975.14.DA	267	05.1017.14ADA	187	05.1037.14ACB	189	05.1057.14A	207	05.1076.40ANI	209
05.0876.14	267	05.0975.14.NI	267	05.1017.14ANI	187	05.1037.14ADA	189	05.1057.14ACB	207	05.1077.14A	209
05.0876.14.DA	267	05.0976.14	267	05.1017.40A	187	05.1037.14ANI	189	05.1057.14ADA	207	05.1077.14ACB	209
05.0876.14.NI	267	05.0976.14.DA	267	05.1017.40ACB	187	05.1037.40A	189	05.1057.14ANI	207	05.1077.14ADA	209
05.0900.14	264	05.0976.14.NI	267	05.1017.40ADA	187	05.1037.40ACB	189	05.1057.40A	207	05.1077.14ANI	209
05.0900.14.DA	264	05.1000.14A	186	05.1017.40ANI	187	05.1037.40ADA	189	05.1057.40ACB	207	05.1077.40A	209
05.0900.14.NI	264	05.1000.14ACB	186	05.1020.14A	188	05.1037.40ANI	189	05.1057.40ADA	207	05.1077.40ACB	209
05.0901.14	264	05.1000.14ADA	186	05.1020.14ACB	188	05.1040.14A	206	05.1057.40ANI	207	05.1077.40ADA	209
05.0901.14.DA	264	05.1000.14ANI	186	05.1020.14ADA	188	05.1040.14ACB	206	05.1060.14A	208	05.1077.40ANI	209
05.0901.14.NI	264	05.1000.40A	186	05.1020.14ANI	188	05.1040.14ADA	206	05.1060.14ACB	208	05.1100.14A	190
05.0905.14	264	05.1000.40ACB	186	05.1020.40A	188	05.1040.14ANI	206	05.1060.14ADA	208	05.1100.14ACB	190
05.0905.14.DA	264	05.1000.40ADA	186	05.1020.40ACB	188	05.1040.40A	206	05.1060.14ANI	208	05.1100.14ADA	190
05.0905.14.NI	264	05.1000.40ANI	186	05.1020.40ADA	188	05.1040.40ACB	206	05.1060.40A	208	05.1100.14ANI	190
05.0906.14	264	05.1001.14A	186	05.1020.40ANI	188	05.1040.40ADA	206	05.1060.40ACB	208	05.1100.40A	190
05.0906.14.DA	264	05.1001.14ACB	186	05.1021.14A	188	05.1040.40ANI	206	05.1060.40ADA	208	05.1100.40ACB	190
05.0906.14.NI	264	05.1001.14ADA	186	05.1021.14ACB	188	05.1041.14A	206	05.1060.40ANI	208	05.1100.40ADA	190
05.0910.14	265	05.1001.14ANI	186	05.1021.14ADA	188	05.1041.14ACB	206	05.1061.14A	208	05.1100.40ANI	190
05.0910.14.DA	265	05.1001.40A	186	05.1021.14ANI	188	05.1041.14ADA	206	05.1061.14ACB	208	05.1101.14A	190
05.0910.14.NI	265	05.1001.40ACB	186	05.1021.40A	188	05.1041.14ANI	206	05.1061.14ADA	208	05.1101.14ACB	190
05.0911.14	265	05.1001.40ADA	186	05.1021.40ACB	188	05.1041.40A	206	05.1061.14ANI	208	05.1101.14ADA	190
05.0911.14.DA	265	05.1001.40ANI	186	05.1021.40ADA	188	05.1041.40ACB	206	05.1061.40A	208	05.1101.14ANI	190
05.0911.14.NI	265	05.1002.14A	186	05.1021.40ANI	188	05.1041.40ADA	206	05.1061.40ACB	208	05.1101.40A	190
05.0915.14	265	05.1002.14ACB	186	05.1022.14A	188	05.1041.40ANI	206	05.1061.40ADA	208	05.1101.40ACB	190

QUICK SEARCH OF PRODUCT

Ref.	Page	Ref.	Page	Ref.	Page	Ref.	Page	Ref.	Page	Ref.	Page
05.2138.40ACB	263	05.2236.14ADA	263	05.2336.14ACB	263	05.7015.74	394	05.7112.74	340	05.7201.74	354
05.2138.40ADA	263	05.2240.14A	260	05.2336.14ADA	263	05.7015.B1	394	05.7112.B1	340	05.7201.B1	354
05.2142.14A	260	05.2240.14ACB	260	05.2340.14A	260	05.7015.BU	394	05.7112.BU	340	05.7201.BU	354
05.2142.14ACB	260	05.2240.14ADA	260	05.2340.14ACB	260	05.7015.CU	394	05.7112.CU	340	05.7201.CU	354
05.2142.14ADA	260	05.2241.14A	260	05.2340.14ADA	260	05.7015.GL	394	05.7112.GL	340	05.7201.GL	354
05.2143.14A	260	05.2241.14ACB	260	05.2341.14A	260	05.7016.74	395	05.7115.74	338	05.7202.74	355
05.2143.14ACB	260	05.2241.14ADA	260	05.2341.14ACB	260	05.7016.B1	395	05.7115.B1	338	05.7202.B1	355
05.2143.14ADA	260	05.2245.14A	260	05.2341.14ADA	260	05.7016.BU	395	05.7115.BU	338	05.7202.BU	355
05.2147.14A	260	05.2245.14ACB	260	05.2345.14A	260	05.7016.CU	395	05.7115.CU	338	05.7202.CU	355
05.2147.14ACB	260	05.2245.14ADA	260	05.2345.14ACB	260	05.7016.GL	395	05.7115.GL	338	05.7202.GL	355
05.2147.14ADA	260	05.2246.14A	260	05.2345.14ADA	260	05.7017.74	396	05.7116.74	339	05.7205.74	353
05.2148.14A	260	05.2246.14ACB	260	05.2346.14A	260	05.7017.B1	396	05.7116.B1	339	05.7205.B1	353
05.2148.14ACB	260	05.2246.14ADA	260	05.2346.14ACB	260	05.7017.BU	396	05.7116.BU	339	05.7205.BU	353
05.2148.14ADA	260	05.2250.14A	261	05.2346.14ADA	260	05.7017.CU	396	05.7116.CU	339	05.7205.CU	353
05.2152.14A	261	05.2250.14ACB	261	05.2350.14A	261	05.7017.GL	396	05.7116.GL	339	05.7205.GL	353
05.2153.14A	261	05.2250.14ADA	261	05.2350.14ACB	261	05.7020.74	398	05.7117.74	340	05.7206.74	354
05.2153.14ACB	261	05.2251.14A	261	05.2350.14ADA	261	05.7020.B1	398	05.7117.B1	340	05.7206.B1	354
05.2153.14ADA	261	05.2251.14ACB	261	05.2351.14A	261	05.7020.BU	398	05.7117.BU	340	05.7206.BU	354
05.2157.14A	261	05.2251.14ADA	261	05.2351.14ACB	261	05.7020.CU	398	05.7117.CU	340	05.7206.CU	354
05.2157.14ACB	261	05.2255.14A	261	05.2351.14ADA	261	05.7020.GL	398	05.7117.GL	340	05.7206.GL	354
05.2157.14ADA	261	05.2255.14ACB	261	05.2355.14A	261	05.7021.74	398	05.7120.74	342	05.7207.74	355
05.2158.14A	261	05.2255.14ADA	261	05.2355.14ACB	261	05.7021.B1	398	05.7120.B1	342	05.7207.B1	355
05.2158.14ACB	261	05.2256.14A	261	05.2355.14ADA	261	05.7021.BU	398	05.7120.BU	342	05.7207.BU	355
05.2158.14ADA	261	05.2256.14ACB	261	05.2356.14A	261	05.7021.CU	398	05.7120.CU	342	05.7207.CU	355
05.2162.14A	262	05.2256.14ADA	261	05.2356.14ACB	261	05.7021.GL	398	05.7120.GL	342	05.7207.GL	355
05.2162.14ACB	262	05.2260.14A	262	05.2356.14ADA	261	05.7030.74	393	05.7121.74	342	05.7210.74	356
05.2162.14ADA	262	05.2260.14ACB	262	05.2360.14A	262	05.7030.B1	393	05.7121.B1	342	05.7210.B1	356
05.2163.14A	262	05.2260.14ADA	262	05.2360.14ACB	262	05.7030.BU	393	05.7121.BU	342	05.7210.BU	356
05.2163.14ACB	262	05.2261.14A	262	05.2360.14ADA	262	05.7030.CU	393	05.7121.CU	342	05.7210.CU	356
05.2163.14ADA	262	05.2261.14ACB	262	05.2361.14A	262	05.7030.GL	393	05.7121.GL	342	05.7210.GL	356
05.2167.14A	262	05.2261.14ADA	262	05.2361.14ACB	262	05.7031.74	393	05.7130.74	337	05.7211.74	357
05.2167.14ACB	262	05.2265.14A	262	05.2361.14ADA	262	05.7031.B1	393	05.7130.B1	337	05.7211.B1	357
05.2167.14ADA	262	05.2265.14ACB	262	05.2365.14A	262	05.7031.BU	393	05.7130.BU	337	05.7211.BU	357
05.2168.14A	262	05.2265.14ADA	262	05.2365.14ACB	262	05.7031.CU	393	05.7130.CU	337	05.7211.CU	357
05.2168.14ACB	262	05.2266.14A	262	05.2365.14ADA	262	05.7031.GL	393	05.7130.GL	337	05.7211.GL	357
05.2168.14ADA	262	05.2266.14ACB	262	05.2366.14A	262	05.7035.74	397	05.7131.74	337	05.7212.74	358
05.2172.14A	263	05.2266.14ADA	262	05.2366.14ACB	262	05.7035.B1	397	05.7131.B1	337	05.7212.B1	358
05.2172.14ACB	263	05.2270.14A	263	05.2366.14ADA	262	05.7035.BU	397	05.7131.BU	337	05.7212.BU	358
05.2172.14ADA	263	05.2270.14ACB	263	05.2370.14A	263	05.7035.CU	397	05.7131.CU	337	05.7212.CU	358
05.2173.14A	263	05.2270.14ADA	263	05.2370.14ACB	263	05.7035.GL	397	05.7131.GL	337	05.7212.GL	358
05.2173.14ACB	263	05.2271.14A	263	05.2370.14ADA	263	05.7036.74	397	05.7135.74	341	05.7215.74	356
05.2173.14ADA	263	05.2271.14ACB	263	05.2371.14A	263	05.7036.B1	397	05.7135.B1	341	05.7215.B1	356
05.2177.14A	263	05.2271.14ADA	263	05.2371.14ACB	263	05.7036.BU	397	05.7135.BU	341	05.7215.BU	356
05.2177.14ACB	263	05.2275.14A	263	05.2371.14ADA	263	05.7036.CU	397	05.7135.CU	341	05.7215.CU	356
05.2177.14ADA	263	05.2275.14ACB	263	05.2375.14A	263	05.7036.GL	397	05.7135.GL	341	05.7215.GL	356
05.2178.14A	263	05.2275.14ADA	263	05.2375.14ACB	263	05.7040.74	399	05.7136.74	341	05.7216.74	357
05.2178.14ACB	263	05.2276.14A	263	05.2375.14ADA	263	05.7040.B1	399	05.7136.B1	341	05.7216.B1	357
05.2178.14ADA	263	05.2276.14ACB	263	05.2376.14A	263	05.7040.BU	399	05.7136.BU	341	05.7216.BU	357
05.2200.14A	260	05.2276.14ADA	263	05.2376.14ACB	263	05.7040.CU	399	05.7136.CU	341	05.7216.CU	357
05.2200.14ACB	260	05.2300.14A	260	05.2376.14ADA	263	05.7040.GL	399	05.7136.GL	341	05.7216.GL	357
05.2200.14ADA	260	05.2300.14ACB	260	05.7000.74	390	05.7041.74	399	05.7140.74	343	05.7217.74	358
05.2201.14A	260	05.2300.14ADA	260	05.7000.B1	390	05.7041.B1	399	05.7140.B1	343	05.7217.B1	358
05.2201.14ACB	260	05.2301.14A	260	05.7000.BU	390	05.7041.BU	399	05.7140.BU	343	05.7217.BU	358
05.2201.14ADA	260	05.2301.14ACB	260	05.7000.CU	390	05.7041.CU	399	05.7140.CU	343	05.7217.CU	358
05.2205.14A	260	05.2301.14ADA	260	05.7000.GL	390	05.7041.GL	399	05.7140.GL	343	05.7217.GL	358
05.2205.14ACB	260	05.2305.14A	260	05.7001.74	391	05.7100.74	333	05.7141.74	343	05.7300.74	295
05.2205.14ADA	260	05.2305.14ACB	260	05.7001.B1	391	05.7100.B1	333	05.7141.B1	343	05.7300.B1	295
05.2206.14A	260	05.2305.14ADA	260	05.7001.BU	391	05.7100.BU	333	05.7141.BU	343	05.7300.BU	295
05.2206.14ACB	260	05.2306.14A	260	05.7001.CU	391	05.7100.CU	333	05.7141.CU	343	05.7300.CU	295
05.2206.14ADA	260	05.2306.14ACB	260	05.7001.GL	391	05.7100.GL	333	05.7141.GL	343	05.7300.GL	295
05.2210.14A	261	05.2306.14ADA	260	05.7002.74	392	05.7101.74	334	05.7150.74	344	05.7301.74	296
05.2210.14ACB	261	05.2310.14A	261	05.7002.B1	392	05.7101.B1	334	05.7150.B1	344	05.7301.B1	296
05.2210.14ADA	261	05.2310.14ACB	261	05.7002.BU	392	05.7101.BU	334	05.7150.BU	344	05.7301.BU	296
05.2211.14A	261	05.2310.14ADA	261	05.7002.CU	392	05.7101.CU	334	05.7150.CU	344	05.7301.CU	296
05.2211.14ACB	261	05.2311.14A	261	05.7002.GL	392	05.7101.GL	334	05.7150.GL	344	05.7301.GL	296
05.2211.14ADA	261	05.2311.14ACB	261	05.7005.74	390	05.7102.74	335	05.7151.74	345	05.7302.74	297
05.2215.14A	261	05.2311.14ADA	261	05.7005.B1	390	05.7102.B1	335	05.7151.B1	345	05.7302.B1	297
05.2215.14ACB	261	05.2315.14A	261	05.7005.BU	390	05.7102.BU	335	05.7151.BU	345	05.7302.BU	297
05.2215.14ADA	261	05.2315.14ACB	261	05.7005.CU	390	05.7102.CU	335	05.7151.CU	345	05.7302.CU	297
05.2216.14A	261	05.2315.14ADA	261	05.7005.GL	390	05.7102.GL	335	05.7151.GL	345	05.7302.GL	297
05.2216.14ACB	261	05.2316.14A	261	05.7006.74	391	05.7105.74	333	05.7152.74	346	05.7305.74	295
05.2216.14ADA	261	05.2316.14ACB	261	05.7006.B1	391	05.7105.B1	333	05.7152.B1	346	05.7305.B1	295
05.2220.14A	262	05.2316.14ADA	261	05.7006.BU	391	05.7105.BU	333	05.7152.BU	346	05.7305.BU	295
05.2220.14ACB	262	05.2320.14A	262	05.7006.CU	391	05.7105.CU	333	05.7152.CU	346	05.7305.CU	295
05.2220.14ADA	262	05.2320.14ACB	262	05.7006.GL	391	05.7105.GL	333	05.7152.GL	346	05.7305.GL	295
05.2221.14A	262	05.2320.14ADA	262	05.7007.74	392	05.7106.74	334	05.7155.74	344	05.7306.74	296
05.2221.14ACB	262	05.2321.14A	262	05.7007.B1	392	05.7106.B1	334	05.7155.B1	344	05.7306.B1	296
05.2221.14ADA	262	05.2321.14ACB	262	05.7007.BU	392	05.7106.BU	334	05.7155.BU	344	05.7306.BU	296
05.2225.14A	262	05.2321.14ADA	262	05.7007.CU	392	05.7106.CU	334	05.7155.CU	344	05.7306.CU	296
05.2225.14ACB	262	05.2325.14A	262	05.7007.GL	392	05.7106.GL	334	05.7155.GL	344	05.7306.GL	296
05.2225.14ADA	262	05.2325.14ACB	262	05.7010.74	394	05.7107.74	335	05.7156.74	345	05.7307.74	297
05.2226.14A	262	05.2325.14ADA	262	05.7010.B1	394	05.7107.B1	335	05.7156.B1	345	05.7307.B1	297
05.2226.14ACB	262	05.2326.14A	262	05.7010.BU	394	05.7107.BU	335	05.7156.BU	345	05.7307.BU	297
05.2226.14ADA	262	05.2326.14ACB	262	05.7010.CU	394	05.7107.CU	335	05.7156.CU	345	05.7307.CU	297
05.2230.14A	263	05.2326.14ADA	262	05.7010.GL	394	05.7107.GL	335	05.7156.GL	345	05.7307.GL	297
05.2230.14ACB	263	05.2330.14A									

QUICK SEARCH OF PRODUCT

Ref.	Page	Ref.	Page	Ref.	Page	Ref.	Page	Ref.	Page	Ref.	Page
05.7312.74	300	05.7415.74	316	05.7442.74	378	05.7463.74	320	06.1626.14	91	06.2511.14	66
05.7312.B1	300	05.7415.B1	316	05.7442.B1	378	05.7463.B1	320	06.1626.40	91	06.2511.18	66
05.7312.BU	300	05.7415.BU	316	05.7442.BU	378	05.7463.BU	320	06.1627.14	91	06.2511.40	66
05.7312.CU	300	05.7415.CU	316	05.7442.CU	378	05.7463.CU	320	06.1627.40	91	06.2511.CZ	66
05.7312.GL	300	05.7415.GL	316	05.7442.GL	378	05.7463.GL	320	06.1628.14	91	06.2540.14	58
05.7315.74	298	05.7416.74	322	05.7443.74	378	05.7464.74	324	06.1628.40	91	06.2540.18	58
05.7315.B1	298	05.7416.B1	322	05.7443.B1	378	05.7464.B1	324	06.1629.14	91	06.2540.40	58
05.7315.BU	298	05.7416.BU	322	05.7443.BU	378	05.7464.BU	324	06.1629.40	91	06.2540.CZ	58
05.7315.CU	298	05.7416.CU	322	05.7443.CU	378	05.7464.CU	324	06.1630.14	91	06.2541.14	58
05.7315.GL	298	05.7416.GL	322	05.7443.GL	378	05.7464.GL	324	06.1630.40	91	06.2541.18	58
05.7316.74	299	05.7417.74	322	05.7444.74	382	05.7465.74	324	06.1631.14	91	06.2541.40	58
05.7316.B1	299	05.7417.B1	322	05.7444.B1	382	05.7465.B1	324	06.1631.40	91	06.2541.CZ	58
05.7316.BU	299	05.7417.BU	322	05.7444.BU	382	05.7465.BU	324	06.1632.14	91	06.2542.14	58
05.7316.CU	299	05.7417.CU	322	05.7444.CU	382	05.7465.CU	324	06.1632.40	91	06.2542.18	58
05.7316.GL	299	05.7417.GL	322	05.7444.GL	382	05.7465.GL	324	06.1633.14	91	06.2542.40	58
05.7317.74	300	05.7420.74	327	05.7445.74	382	06.0097.00	168	06.1633.40	91	06.2542.CZ	58
05.7317.B1	300	05.7420.B1	327	05.7445.B1	382	06.0098.00	168	06.1634.14	91	06.2543.14	58
05.7317.BU	300	05.7420.BU	327	05.7445.BU	382	06.0157.00	115	06.1634.40	91	06.2543.18	58
05.7317.CU	300	05.7420.CU	327	05.7445.CU	382	06.0173.14	15	06.1635.14	91	06.2543.40	58
05.7317.GL	300	05.7420.GL	327	05.7445.GL	382	06.0301.00	149	06.1635.40	91	06.2543.CZ	58
05.7400.74	372	05.7421.74	327	05.7446.74	363	06.0303.00	149	06.1638.14	88	06.2544.14	58
05.7400.B1	372	05.7421.B1	327	05.7446.B1	363	06.1003.00	643	06.1639.14	88	06.2544.18	58
05.7400.BU	372	05.7421.BU	327	05.7446.BU	363	06.1005.00	643	06.1640.14	88	06.2544.40	58
05.7400.CU	372	05.7421.CU	327	05.7446.CU	363	06.1005.00	670	06.1641.14	88	06.2544.CZ	58
05.7400.GL	372	05.7421.GL	327	05.7446.GL	363	06.1011.00	643	06.1642.14	88	06.2545.14	59
05.7401.74	374	05.7422.74	329	05.7447.74	363	06.1012.00	643	06.1643.14	88	06.2545.18	59
05.7401.B1	374	05.7422.B1	329	05.7447.B1	363	06.1012.00	670	06.1644.14	88	06.2545.40	59
05.7401.BU	374	05.7422.BU	329	05.7447.BU	363	06.1013.00	644	06.1645.14	88	06.2545.CZ	59
05.7401.CU	374	05.7422.CU	329	05.7447.CU	363	06.1013.00	670	06.1646.14	88	06.2546.14	59
05.7401.GL	374	05.7422.GL	329	05.7447.GL	363	06.1014.00	644	06.1647.14	88	06.2546.18	59
05.7402.74	376	05.7423.74	329	05.7450.74	301	06.1014.00	671	06.1648.14	88	06.2546.40	59
05.7402.B1	376	05.7423.B1	329	05.7450.B1	301	06.1016.00	636	06.1650.14	88	06.2546.CZ	59
05.7402.BU	376	05.7423.BU	329	05.7450.BU	301	06.1016.00	670	06.1651.14	88	06.5008.14	113
05.7402.CU	376	05.7423.CU	329	05.7450.CU	301	06.1019.00	643	06.1656.14	91	06.5010.05	114
05.7402.GL	376	05.7423.GL	329	05.7450.GL	301	06.1019.00	670	06.1656.40	91	06.5010.14	114
05.7403.74	372	05.7430.74	361	05.7451.74	301	06.1020.00	644	06.1657.14	91	06.5010.40	114
05.7403.B1	372	05.7430.B1	361	05.7451.B1	301	06.1022.00	636	06.1657.40	91	06.5011.05	114
05.7403.BU	372	05.7430.BU	361	05.7451.BU	301	06.1022.00	670	06.1740.14	91	06.5011.14	114
05.7403.CU	372	05.7430.CU	361	05.7451.CU	301	06.1022.00	671	06.1741.14	91	06.5011.40	114
05.7403.GL	372	05.7430.GL	361	05.7451.GL	301	06.1023.00	636	06.1742.14	91	06.5012.05	114
05.7404.74	374	05.7431.74	361	05.7452.74	305	06.1024.00	637	06.1800.14	134	06.5012.14	114
05.7404.B1	374	05.7431.B1	361	05.7452.B1	305	06.1025.00	636	06.1801.14	134	06.5012.40	114
05.7404.BU	374	05.7431.BU	361	05.7452.BU	305	06.1026.00	636	06.1802.14	134	06.5013.05	114
05.7404.CU	374	05.7431.CU	361	05.7452.CU	305	06.1027.00	636	06.1803.14	134	06.5013.14	114
05.7404.GL	374	05.7431.GL	361	05.7452.GL	305	06.1028.00	637	06.1804.14	134	06.5013.40	114
05.7405.74	376	05.7432.74	367	05.7453.74	305	06.1032.00	289	06.1805.14	134	06.5014.14	114
05.7405.B1	376	05.7432.B1	367	05.7453.B1	305	06.1033.00	289	06.1806.14	134	06.5014.40	114
05.7405.BU	376	05.7432.BU	367	05.7453.BU	305	06.1034.00	289	06.1807.14	134	06.5015.05	114
05.7405.CU	376	05.7432.CU	367	05.7453.CU	305	06.1049.00	670	06.1850.14	148	06.5015.14	114
05.7405.GL	376	05.7432.GL	367	05.7453.GL	305	06.1600.14	89	06.1851.14	148	06.5015.40	114
05.7406.74	365	05.7433.74	367	05.7454.74	307	06.1600.40	89	06.1852.14	148	06.5016.05	114
05.7406.B1	365	05.7433.B1	367	05.7454.B1	307	06.1601.14	89	06.1853.14	148	06.5016.14	114
05.7406.BU	365	05.7433.BU	367	05.7454.BU	307	06.1601.40	89	06.1860.14	149	06.5016.40	114
05.7406.CU	365	05.7433.CU	367	05.7454.CU	307	06.1602.14	89	06.1860.40	149	06.5017.05	114
05.7406.GL	365	05.7433.GL	367	05.7454.GL	307	06.1602.40	89	06.1861.14	149	06.5017.14	114
05.7407.74	365	05.7434.74	385	05.7455.74	307	06.1603.14	89	06.1861.40	149	06.5017.40	114
05.7407.B1	365	05.7434.B1	385	05.7455.B1	307	06.1603.40	89	06.1862.14	149	06.5020.05	116
05.7407.BU	365	05.7434.BU	385	05.7455.BU	307	06.1604.14	89	06.1862.40	149	06.5020.14	116
05.7407.CU	365	05.7434.CU	385	05.7455.CU	307	06.1604.40	89	06.1863.14	149	06.5020.40	116
05.7407.GL	365	05.7434.GL	385	05.7455.GL	307	06.1605.14	89	06.1863.40	149	06.5021.05	116
05.7408.74	369	05.7435.74	385	05.7456.74	311	06.1605.40	89	06.1987.14	107	06.5021.14	116
05.7408.B1	369	05.7435.B1	385	05.7456.B1	311	06.1606.14	89	06.1987.14	153	06.5021.40	116
05.7408.BU	369	05.7435.BU	385	05.7456.BU	311	06.1606.40	89	06.1987.40	107	06.5022.05	116
05.7408.CU	369	05.7435.CU	385	05.7456.CU	311	06.1607.14	89	06.1987.40	153	06.5022.14	116
05.7408.GL	369	05.7435.GL	385	05.7456.GL	311	06.1607.40	89	06.1988.14	29	06.5022.40	116
05.7409.74	369	05.7436.74	387	05.7457.74	311	06.1608.14	89	06.1988.14	129	06.5023.05	116
05.7409.B1	369	05.7436.B1	387	05.7457.B1	311	06.1608.40	89	06.1988.40	29	06.5023.14	116
05.7409.BU	369	05.7436.BU	387	05.7457.BU	311	06.1609.14	89	06.1988.40	129	06.5023.40	116
05.7409.CU	369	05.7436.CU	387	05.7457.CU	311	06.1609.40	89	06.2500.06	58	06.5024.14	116
05.7409.GL	369	05.7436.GL	387	05.7457.GL	311	06.1610.14	89	06.2500.14	58	06.5024.40	116
05.7410.74	303	05.7437.74	387	05.7458.74	314	06.1610.40	89	06.2500.18	58	06.5025.05	117
05.7410.B1	303	05.7437.B1	387	05.7458.B1	314	06.1612.14	89	06.2500.40	58	06.5025.14	117
05.7410.BU	303	05.7437.BU	387	05.7458.BU	314	06.1612.40	89	06.2500.CZ	58	06.5025.40	117
05.7410.CU	303	05.7437.CU	387	05.7458.CU	314	06.1614.14A	90	06.2501.06	58	06.5026.05	117
05.7410.GL	303	05.7437.GL	387	05.7458.GL	314	06.1614.40A	90	06.2501.14	58	06.5026.14	117
05.7411.74	303	05.7438.74	380	05.7459.74	314	06.1615.14A	90	06.2501.18	58	06.5026.40	117
05.7411.B1	303	05.7438.B1	380	05.7459.B1	314	06.1615.40A	90	06.2501.40	58	06.5040.14	112
05.7411.BU	303	05.7438.BU	380	05.7459.BU	314	06.1616.14A	90	06.2501.CZ	58	06.5041.14	112
05.7411.CU	303	05.7438.CU	380	05.7459.CU	314	06.1616.40A	90	06.2502.06	58	06.5042.14	112
05.7411.GL	303	05.7438.GL	380	05.7459.GL	314	06.1617.14A	90	06.2502.14	58	06.5043.14	112
05.7412.74	309	05.7439.74	380	05.7460.74	318	06.1617.40A	90	06.2502.18	58	06.5044.14	112
05.7412.B1	309	05.7439.B1	380	05.7460.B1	318	06.1618.14A	90	06.2502.40	58	06.5045.14	112
05.7412.BU	309	05.7439.BU	380	05.7460.BU	318	06.1618.40A	90	06.2502.CZ	58	06.5046.14	112
05.7412.CU	309	05.7439.CU	380	05.7460.CU	318	06.1619.14A	90	06.2506.14	58	06.5047.14	112
05.7412.GL	309	05.7439.GL	380	05.7460.GL	318	06.1619.40A	90	06.2506.40	58	06.5050.14	112
05.7413.74	309	05.7440.74	359	05.7461.74	318	06.1620.14A	90	06.2509.14	59	06.5051.14	112
05.7413.B1	309	05.7440.B1	359	05.7461.B1	318	06.1620.40A	90	06.2509.18	59	06.5052.14	112
05.7413.BU	309	05.7440.BU	359	05.7461.BU	318	06.1621.14A	90	06.2509.40	59	06.5053.14	112
05.7413.CU	30										

QUICK SEARCH OF PRODUCT

Ref.	Page	Ref.	Page	Ref.	Page	Ref.	Page	Ref.	Page	Ref.	Page
06.5062.05	114	06.5303.1A	50	06.6036.14	72	08.0500.00	465	08.0613.14A	29	08.8118.68	439
06.5062.14	114	06.5303.40	50	06.6036.14	73	08.0501.00	465	08.0613.14A	129	08.8119.00	438
06.5062.40	114	06.5303.CZ	50	06.6036.40	73	08.0505.00	465	08.0614.14	112	08.8137.00	438
06.5063.05	114	06.5304.14	51	07.9630.18	591	08.0506.14	465	08.0614.14	114	08.8149.02	444
06.5063.14	114	06.5304.1A	51	07.9630.18	591	08.0506.40	465	08.0614.14	117	08.8149.14	444
06.5063.40	114	06.5304.40	51	07.9630.70	590	08.0506.CE	465	08.0615.00	115	08.8149.30	444
06.5064.14	114	06.5304.CZ	51	07.9630.70	590	08.0506.TK	465	08.0616.00	115	08.8152.00	444
06.5064.40	114	06.5305.14	51	07.9630.76	591	08.0507.14	465	08.0626.00	117	08.8156.00	400
06.5070.05	116	06.5305.1A	51	07.9630.76	591	08.0507.40	465	08.0627.00	117	08.8160.64.OD	445
06.5070.14	116	06.5305.40	51	07.9630.7C	591	08.0507.CE	465	08.0630.14	59	08.8160.64.OD	539
06.5070.40	116	06.5305.CZ	51	07.9630.7C	591	08.0507.TK	465	08.0630.40	59	08.8160.65.OD	445
06.5071.05	116	06.5306.14	51	07.9630.AN	590	08.0510.00	259	08.0631.14	117	08.8160.65.OD	539
06.5071.14	116	06.5306.1A	51	07.9630.AN	590	08.0511.00	259	08.0631.40	117	08.8160.66.OD	445
06.5071.40	116	06.5306.40	51	07.9630.AP	590	08.0512.00	259	08.0632.14	117	08.8160.66.OD	539
06.5072.05	116	06.5306.CZ	51	07.9630.AP	590	08.0513.00	259	08.0632.40	117	08.8160.67.OD	445
06.5072.14	116	06.5310.14	50	07.9630.CE	591	08.0515.00	259	08.0640.02	580	08.8160.67.OD	539
06.5072.40	116	06.5310.1A	50	07.9630.CE	591	08.0516.00	259	08.0640.14	580	08.8160.68	445
06.5073.05	116	06.5310.40	50	07.9641.14A	590	08.0517.00	259	08.0640.40	580	08.8160.68	539
06.5073.14	116	06.5310.CZ	50	07.9641.14ADA	590	08.0518.00	259	08.0640.ET	580	08.8160.69	445
06.5073.40	116	06.5311.14	50	07.9641.14ADP	590	08.0520.02	580	08.0640.EU	580	08.8160.69	539
06.5074.14	116	06.5311.1A	50	07.9642.14A	590	08.0520.14	580	08.0641.02	580	08.8160.98.OD	445
06.5074.40	116	06.5311.40	50	07.9642.14ADA	590	08.0520.40	580	08.0641.14	580	08.8160.98.OD	539
06.5100.14	18	06.5311.CZ	50	07.9642.14ADP	590	08.0520.ET	580	08.0641.40	580	08.8160.CL	445
06.5100.40	18	06.5312.14	51	08.0030	163	08.0520.EU	580	08.0641.ET	580	08.8160.CL	539
06.5101.14	18	06.5312.1A	51	08.0031.00	163	08.0521.02	580	08.0641.EU	580	08.8160.DL	445
06.5101.40	18	06.5312.40	51	08.0031.00.DA	163	08.0521.14	580	08.0642.02	581	08.8160.DL	539
06.5110.14	18	06.5312.CZ	51	08.0032.00	18	08.0521.40	580	08.0642.14	581	08.8160.ND	445
06.5110.40	18	06.5313.14	51	08.0033.00	18	08.0521.ET	580	08.0642.40	581	08.8160.ND	539
06.5111.14	18	06.5313.1A	51	08.0050.00	107	08.0521.EU	580	08.0642.ET	581	08.8163.68	426
06.5111.40	18	06.5313.40	51	08.0050.00	128	08.0522.02	580	08.0642.EU	581	08.8163.68	445
06.5112.14	18	06.5313.CZ	51	08.0050.00	453	08.0522.14	580	08.3309.14	175	08.8163.68	517
06.5112.40	18	06.5314.14	50	08.0052.90	259	08.0522.40	580	08.3310.19	175	08.8163.68	539
06.5113.14	18	06.5314.1A	50	08.0059.90	259	08.0522.ET	580	08.8025.08	479	08.8166.14	445
06.5113.40	18	06.5314.40	50	08.0109.00	163	08.0522.EU	580	08.8025.14	479	08.8166.14	539
06.5115.14	19	06.5314.CZ	50	08.0110.00	163	08.0523.02	580	08.8025.20	479	08.8169.14	445
06.5115.40	19	06.5315.14	51	08.0111.00	163	08.0523.14	580	08.8027.08.AC	479	08.8169.14	539
06.5116.14	19	06.5315.1A	51	08.0112.00	163	08.0523.40	580	08.8027.08.AM	479	08.8175.68	426
06.5116.40	19	06.5315.40	51	08.0113.00	163	08.0523.ET	580	08.8027.08.AO	479	08.8175.68	445
06.5117.14	19	06.5315.CZ	51	08.0114.00	163	08.0523.EU	580	08.8027.08.CL	479	08.8175.68	517
06.5117.40	19	06.5400.14	33	08.0132.00	400	08.0524.02	581	08.8027.08.DL	479	08.8175.68	539
06.5118.14	19	06.5400.40	33	08.0160.14	281	08.0524.14	581	08.8027.08.HL	479	08.8180.08	479
06.5118.40	19	06.5401.14	33	08.0160.40	281	08.0524.40	581	08.8027.08.IR	479	08.8180.14	479
06.5120.14	19	06.5401.40	33	08.0161.14	281	08.0524.ET	581	08.8027.08.ND	479	08.8180.20	479
06.5120.40	19	06.5402.14	33	08.0161.40	281	08.0524.EU	581	08.8027.08.RO	479	08.8182.14	175
06.5121.14	19	06.5402.40	33	08.0164.14	281	08.0525.02	581	08.8027.08.UV	479	08.8186.14	539
06.5121.40	19	06.5403.14	33	08.0164.40	281	08.0525.14	581	08.8027.14.AC	479	08.8187.00	471
06.5122.14	19	06.5403.40	33	08.0165.14	281	08.0525.40	581	08.8027.14.AM	479	08.8188.00	471
06.5122.40	19	06.5404.14	33	08.0165.40	281	08.0525.ET	581	08.8027.14.AO	479	08.8191.00	471
06.5123.14	19	06.5404.40	33	08.0166.00	281	08.0525.EU	581	08.8027.14.CL	479	08.8192.00	471
06.5123.40	19	06.5405.14	33	08.0167.00	281	08.0526.00	29	08.8027.14.DL	479	08.8196.14	471
06.5125.14	19	06.5405.40	33	08.0175.14	493	08.0526.00	128	08.8027.14.HL	479	08.8196.14	575
06.5125.40	19	06.5410.14	33	08.0176.14	493	08.0526.00	143	08.8027.14.IR	479	08.8222.30A	419
06.5126.14	19	06.5410.40	33	08.0177.14	493	08.0526.00	152	08.8027.14.ND	479	08.8229.30A	419
06.5126.40	19	06.5411.14	33	08.0178.14	493	08.0526.00	426	08.8027.14.RO	479	08.8230.64.OD	175
06.5127.14	19	06.5411.40	33	08.0180.00	15	08.0526.00	466	08.8027.14.UV	479	08.8230.65.OD	175
06.5127.40	19	06.5412.14	33	08.0181.00	15	08.0526.00	517	08.8027.20.AC	479	08.8230.66.OD	175
06.5128.14	19	06.5412.40	33	08.0182.00	15	08.0526.00	559	08.8027.20.AM	479	08.8230.67.OD	175
06.5128.40	19	06.5413.14	33	08.0190.14	82	08.0526.40	29	08.8027.20.AO	479	08.8230.69	175
06.5135.14A	18	06.5413.40	33	08.0191.14	82	08.0526.40	128	08.8027.20.CL	479	08.8230.98.OD	175
06.5135.40A	18	06.5414.14	33	08.0192.00	281	08.0526.40	143	08.8027.20.DL	479	08.8230.CL	175
06.5140.14	18	06.5414.40	33	08.0193.00	281	08.0526.40	152	08.8027.20.HL	479	08.8230.DL	175
06.5140.40	18	06.5415.14	33	08.0194.00	15	08.0526.40	426	08.8027.20.IR	479	08.8230.ND	175
06.5141.14	18	06.5415.40	33	08.0195.00	15	08.0526.40	517	08.8027.20.ND	479	08.8232.02	445
06.5141.40	18	06.5420.14	33	08.0205.00A	555	08.0526.40	559	08.8027.20.RO	479	08.8232.02	539
06.5142.14A	18	06.5420.40	33	08.0206.00	555	08.0526.BW	29	08.8027.20.UV	479	08.8232.14	445
06.5142.40A	18	06.5421.14	33	08.0207.00A	555	08.0526.BW	128	08.8029.08	479	08.8232.14	539
06.5150.14	19	06.5421.40	33	08.0208.00	555	08.0526.BW	143	08.8029.14	479	08.8232.30	445
06.5150.40	19	06.5430.14	33	08.0209.DR	555	08.0526.BW	152	08.8029.20	479	08.8232.30	539
06.5151.14	19	06.5430.40	33	08.0209.DY	555	08.0526.BW	426	08.8030.08	479	08.8238.14	471
06.5151.40	19	06.6000.14	72	08.0209.EQ	555	08.0526.BW	517	08.8030.14	479	08.8238.14	575
06.5152.14	19	06.6001.14	72	08.0209.ER	555	08.0526.BW	559	08.8030.20	479	08.8239.00B	419
06.5152.40	19	06.6002.14	72	08.0209.ES	555	08.0550.00	465	08.8034.14	451	08.8240.00B	419
06.5153.14	19	06.6003.14	72	08.0210.00A	555	08.0551.00	465	08.8034.14	471	08.8242.14	439
06.5153.40	19	06.6004.14	72	08.0211.DR	555	08.0555.00	465	08.8034.14	575	08.8243.00	419
06.5155.14	19	06.6010.14	73	08.0211.DY	555	08.0556.14	465	08.8036.14	451	08.8243.00.1U	419
06.5155.40	19	06.6010.40	73	08.0211.EQ	555	08.0556.40	465	08.8036.14	471	08.8243.00.5U	419
06.5156.14	19	06.6011.14	73	08.0211.FR	555	08.0556.CE	465	08.8036.14	575	08.8250.00	419
06.5156.40	19	06.6011.40	73	08.0211.ES	555	08.0556.TK	465	08.8041.68	413	08.8251.00	400
06.5157.14	19	06.6012.14	73	08.0212.DRA	555	08.0557.14	465	08.8041.68	419	08.8270.00	667
06.5157.40	19	06.6012.40	73	08.0212.DYA	555	08.0557.40	465	08.8041.68	451	08.8270.00	668
06.5158.14	19	06.6013.14	73	08.0212.EQA	555	08.0557.CE	465	08.8042.64.OD	451	08.8270.00	668
06.5158.40	19	06.6013.40	73	08.0212.ERA	555	08.0557.TK	465	08.8042.65.OD	451	08.8270.00	669
06.5300.14	50	06.6014.14	73	08.0212.ESA	555	08.0580.00	272	08.8042.66.OD	451	08.8270.14	483
06.5300.1A	50	06.6014.40	73	08.0226.00A	555	08.0581.00	272	08.8042.67.OD	451	08.8294.00A	636
06.5300.40	50	06.6030.14	72	08.0227.00	555	08.0582.00	272	08.8042.68	451	08.8296.00A	636
06.5300.CZ	50	06.6031.14	73	08.0228.DR	555	08.0583.00	272	08.8042.69	451	08.8297.00	637
06.5301.14	50	0									

QUICK SEARCH OF PRODUCT

Ref.	Page	Ref.	Page	Ref.	Page	Ref.	Page	Ref.	Page	Ref.	Page
08.8315.00	635	08.8502.14	175	08.8766.67.OD	526	08.9107.00	517	09.1632.02C	442	09.2151.30A	544
08.8316.00	635	08.8502.14	545	08.8768.14	526	08.9107.00	559	09.1632.02C1V	442	09.2152.05A	544
08.8320.00	635	08.8503.64.OD	479	08.8775.40	591	08.9108.00	143	09.1632.02CDA	442	09.2152.14A	544
08.8321.00	635	08.8503.65.OD	479	08.8782.30	499	08.9108.00	517	09.1632.14C	442	09.2152.30A	544
08.8322.00	635	08.8503.66.OD	479	08.8783.06	499	08.9108.00	559	09.1632.14C1V	442	09.2155.05A	545
08.8330.00	635	08.8503.67.OD	479	08.8783.14	499	08.9109.00	143	09.1632.14CDA	442	09.2155.14A	545
08.8356.00	635	08.8503.69	479	08.8783.30	499	08.9109.00	517	09.1632.30C	442	09.2155.30A	545
08.8359.00	438	08.8503.CL	479	08.8865.14A	88	08.9109.00	559	09.1632.30C1V	442	09.2156.05A	545
08.8363.14	175	08.8503.DL	479	08.8866.14	88	08.9110.00	143	09.1632.30CDA	442	09.2156.14A	545
08.8363.30	175	08.8503.ND	479	08.8866.14	113	08.9110.00	517	09.1635.02C	442	09.2156.30A	545
08.8377.14	439	08.8512.00C	636	08.8866.14	148	08.9110.00	559	09.1635.02C1V	442	09.2157.05A	545
08.8380.14	175	08.8513.00C	636	08.8867.14	88	08.9111.00	143	09.1635.02CDA	442	09.2157.14A	545
08.8380.30	175	08.8523.00	478	08.8867.14	113	08.9111.00	517	09.1635.14C	442	09.2157.30A	545
08.8410.00	426	08.8524.00	478	08.8867.14	148	08.9111.00	559	09.1635.14C1V	442	09.2160.05A	544
08.8410.00	517	08.8525.00	478	08.8883.14A	92	08.9114.00	400	09.1635.14CDA	442	09.2160.14A	544
08.8411.00	426	08.8526.00	478	08.8883.14A	115	09.0045.29B	595	09.1635.30C	442	09.2160.30A	544
08.8411.00	517	08.8572.14C	284	08.8883.14A	117	09.0045.30B	595	09.1635.30C1V	442	09.2161.05A	544
08.8412.14	413	08.8572.14C	284	08.8883.40A	92	09.0045.BZB	595	09.1635.30CDA	442	09.2161.14A	544
08.8412.14	419	08.8572.14C	285	08.8883.40A	115	09.0100.29B	595	09.1636.02C	442	09.2161.30A	544
08.8413.00	438	08.8572.14C1V	284	08.8883.40A	117	09.0100.30B	595	09.1636.02C1V	442	09.2162.05A	544
08.8414.00	438	08.8572.14C1V	284	08.8886.14	92	09.0100.BZB	595	09.1636.02CDA	442	09.2162.14A	544
08.8415.00	438	08.8572.14C1V	285	08.8886.14.DA	92	09.0101.29B	595	09.1636.14C	442	09.2162.30A	544
08.8418.68A	107	08.8572.14CDA	284	08.8886.40	92	09.0101.30B	595	09.1636.14C1V	442	09.2165.05A	545
08.8418.68A	128	08.8572.14CDA	284	08.8886.40.DA	92	09.0101.BZB	595	09.1636.14CDA	442	09.2165.14A	545
08.8418.68A	453	08.8572.14CDA	285	08.8887.14A	89	09.0102.29B	595	09.1636.30C	442	09.2165.30A	545
08.8419.14A	107	08.8573.14C	284	08.8887.14A	91	09.0102.30B	595	09.1636.30C1V	442	09.2166.05A	545
08.8419.14A	128	08.8573.14C	284	08.8887.40A	89	09.0102.BZB	595	09.1636.30CDA	442	09.2166.14A	545
08.8419.14A	453	08.8573.14C	285	08.8887.40A	91	09.0103.29B	595	09.1637.02C	442	09.2166.30A	545
08.8420.00	400	08.8573.14C1V	284	08.8889.14	92	09.0103.30B	595	09.1637.02C1V	442	09.2167.05A	545
08.8421.00	400	08.8573.14C1V	284	08.8889.14	115	09.0103.BZB	595	09.1637.02CDA	442	09.2167.14A	545
08.8422.00	603	08.8573.14C1V	285	08.8889.14	117	09.0104.29A	595	09.1637.14C	442	09.2167.30A	545
08.8423.00	605	08.8573.14CDA	284	08.8889.40	92	09.0104.30A	595	09.1637.14C1V	442	09.2400.02C	531
08.8427.14	97	08.8573.14CDA	284	08.8889.40	115	09.0104.BZA	595	09.1637.14CDA	442	09.2400.14C	531
08.8428.00	29	08.8573.14CDA	285	08.8889.40	117	09.0120.29B	595	09.1637.30C	442	09.2400.30C	531
08.8428.00	128	08.8590.06A	640	08.8930.68	451	09.0120.30B	595	09.1637.30C1V	442	09.2401.02C	531
08.8428.00	143	08.8590.40A	640	08.8931.68	451	09.0120.BZB	595	09.1637.30CDA	442	09.2401.14C	531
08.8428.00	152	08.8590.AAA	640	08.8932.64.OD	451	09.0203.14	174	09.1640.02B	443	09.2401.30C	531
08.8428.00	426	08.8591.06A	640	08.8932.65.OD	451	09.0203.30	174	09.1640.14B	443	09.2402.02C	531
08.8428.00	466	08.8591.40A	640	08.8932.66.OD	451	09.0211.14A	173	09.1640.30B	443	09.2402.14C	531
08.8428.00	517	08.8591.AAA	640	08.8932.67.OD	451	09.0211.30A	173	09.1641.02B	443	09.2402.30C	531
08.8428.00	559	08.8595.06A	640	08.8932.69	451	09.0212.14A	173	09.1641.14B	443	09.2405.02B	533
08.8429.00	29	08.8595.40A	640	08.8932.98.OD	451	09.0212.30A	173	09.1641.30B	443	09.2405.14B	533
08.8429.00	128	08.8595.AAA	640	08.8932.CL	451	09.0213.14A	173	09.1642.02B	443	09.2405.30B	533
08.8429.00	143	08.8596.06A	640	08.8932.DL	451	09.0213.30A	173	09.1642.14B	443	09.2406.02B	533
08.8429.00	152	08.8596.40A	640	08.8932.ND	451	09.0217.14A	173	09.1642.30B	443	09.2406.14B	533
08.8429.00	426	08.8596.AAA	640	08.8933.68	451	09.0217.30A	173	09.1645.02B	443	09.2406.30B	533
08.8429.00	466	08.8627.68	175	08.8974.00	405	09.0218.14A	173	09.1645.14B	443	09.2407.02B	533
08.8429.00	517	08.8634.00	115	08.8975.00	405	09.0218.30A	173	09.1645.30B	443	09.2407.14B	533
08.8429.00	559	08.8634.00	117	08.8976.14	405	09.0219.14A	173	09.1646.02B	443	09.2407.30B	533
08.8431.00	29	08.8662.14C	284	08.8977.00	405	09.0219.30A	173	09.1646.14B	443	09.2410.02C	531
08.8431.00	128	08.8662.14C	284	08.8978.00	405	09.0220.14A	174	09.1646.30B	443	09.2410.14C	531
08.8431.00	143	08.8662.14C	285	08.8979.00	405	09.0220.30A	174	09.1647.02B	443	09.2410.30C	531
08.8431.00	152	08.8662.14C1V	284	08.8980.14	405	09.0221.14A	174	09.1647.14B	443	09.2411.02C	531
08.8431.00	426	08.8662.14C1V	284	08.8994.14	426	09.0221.30A	174	09.1647.30B	443	09.2411.14C	531
08.8431.00	466	08.8662.14C1V	285	08.8994.30	426	09.0230.14	174	09.2110.05C	593	09.2411.30C	531
08.8431.00	517	08.8662.14CDA	284	08.8995.14	426	09.0230.30	174	09.2110.05CDA	593	09.2412.02C	531
08.8431.00	559	08.8662.14CDA	284	08.8995.30	426	09.0231.14	174	09.2110.14C	593	09.2412.14C	531
08.8432.00	29	08.8662.14CDA	285	08.9050.02	163	09.0231.30	174	09.2110.14CDA	593	09.2412.30C	531
08.8432.00	128	08.8663.14C	284	08.9050.40	163	09.0232.14	174	09.2110.40C	593	09.2415.02B	533
08.8432.00	143	08.8663.14C	284	08.9050.NS	163	09.0232.30	174	09.2110.40CDA	593	09.2415.14B	533
08.8432.00	152	08.8663.14C	285	08.9051.02	163	09.0233.14	174	09.2111.05A	593	09.2415.30B	533
08.8432.00	426	08.8663.14C1V	284	08.9051.40	163	09.0233.30	174	09.2111.05ADA	593	09.2416.02B	533
08.8432.00	466	08.8663.14C1V	284	08.9051.NS	163	09.0360.14	173	09.2111.14A	593	09.2416.14B	533
08.8432.00	517	08.8663.14C1V	285	08.9052.02	163	09.0360.30	173	09.2111.14ADA	593	09.2416.30B	533
08.8432.00	559	08.8663.14CDA	284	08.9052.40	163	09.0361.14	173	09.2111.40A	593	09.2417.02B	533
08.8439.14	134	08.8663.14CDA	284	08.9052.NS	163	09.0361.30	173	09.2111.40ADA	593	09.2417.14B	533
08.8450.00	439	08.8663.14CDA	285	08.9053.02	163	09.0362.14	173	09.2112.05A	593	09.2417.30B	533
08.8451.00	439	08.8701.14	172	08.9053.40	163	09.0362.30	173	09.2112.05ADA	593	09.2420.02C	535
08.8452.00	439	08.8701.30	172	08.9053.NS	163	09.0365.14	173	09.2112.14A	593	09.2420.14C	535
08.8453.14	439	08.8702.14	172	08.9054.02	163	09.0365.30	173	09.2112.14ADA	593	09.2420.30C	535
08.8453.40	439	08.8702.30	172	08.9054.40	163	09.0366.14	173	09.2112.40A	593	09.2421.02C	535
08.8479.00	400	08.8705.14	172	08.9054.NS	163	09.0366.30	173	09.2112.40ADA	593	09.2421.14C	535
08.8491.14	400	08.8705.30	172	08.9055.02	163	09.0367.14	173	09.2125.05B	593	09.2421.30C	535
08.8491.30	400	08.8706.14	172	08.9055.40	163	09.0367.30	173	09.2125.05BDM	593	09.2422.02C	535
08.8491.BU	400	08.8706.30	172	08.9055.NS	163	09.1600.02	444	09.2125.14B	593	09.2422.14C	535
08.8491.GL	400	08.8707.14	172	08.9056.02	163	09.1600.14	444	09.2125.14BDM	593	09.2422.30C	535
08.8495.14	426	08.8707.30	172	08.9056.40	163	09.1600.30	444	09.2125.40B	593	09.2425.02B	537
08.8495.14	479	08.8708.14	172	08.9056.NS	163	09.1630.02C	442	09.2125.40BDM	593	09.2425.14B	537
08.8495.14	517	08.8708.30	172	08.9057.02	163	09.1630.02C1V	442	09.2126.05	593	09.2425.30B	537
08.8501.64.OD	175	08.8709.14	172	08.9057.40	163	09.1630.02CDA	442	09.2126.05.DM	593	09.2426.02B	537
08.8501.64.OD	545	08.8709.30	172	08.9057.NS	163	09.1630.14C	442	09.2126.14	593	09.2426.14B	537
08.8501.65.OD	175	08.8710.14	172	08.9058.02	163	09.1630.14C1V	442	09.2126.14.DM	593	09.2426.30B	537
08.8501.65.OD	545	08.8710.30	172	08.9058.40	163	09.1630.14CDA	442	09.2126.40	593	09.2427.02B	53

QUICK SEARCH OF PRODUCT

Ref.	Page	Ref.	Page	Ref.	Page	Ref.	Page	Ref.	Page	Ref.	Page
09.2435.14B	537	09.2581.02A	534	09.2888.30	520	09.2991.14.DA	522	09.3803.18A	60	09.3841.CZA	48
09.2435.30B	537	09.2581.14A	534	09.2888.30.DA	520	09.2991.30	522	09.3803.40A	60	09.3841.CZA	65
09.2436.02B	537	09.2581.30A	534	09.2889.14	520	09.2991.30.DA	522	09.3803.CZA	60	09.3842.06A	65
09.2436.14B	537	09.2585.02A	535	09.2889.14.DA	520	09.2992.14	522	09.3810.06A	61	09.3842.14A	48
09.2436.30B	537	09.2585.14A	535	09.2889.30	520	09.2992.14.DA	522	09.3810.14A	61	09.3842.14A	65
09.2437.02B	537	09.2585.30A	535	09.2889.30.DA	520	09.2992.30	522	09.3810.18A	61	09.3842.18A	65
09.2437.14B	537	09.2586.02A	535	09.2890.14	520	09.2992.30.DA	522	09.3810.40A	61	09.3842.1AA	48
09.2437.30B	537	09.2586.14A	535	09.2890.14.DA	520	09.2993.14	522	09.3810.CZA	61	09.3842.40A	48
09.2450.02C	532	09.2586.30A	535	09.2890.30	520	09.2993.14.DA	522	09.3811.06A	61	09.3842.40A	65
09.2450.14C	532	09.2865.14	525	09.2890.30.DA	520	09.2993.30	522	09.3811.14A	61	09.3842.CZA	48
09.2450.30C	532	09.2865.14.DA	525	09.2891.14	523	09.2993.30.DA	522	09.3811.18A	61	09.3842.CZA	65
09.2451.02C	532	09.2865.30	525	09.2891.14.DA	523	09.2994.14	523	09.3811.40A	61	09.3843.06A	65
09.2451.14C	532	09.2865.30.DA	525	09.2891.30	523	09.2994.14.DA	523	09.3811.CZA	61	09.3843.14A	48
09.2451.30C	532	09.2866.14	525	09.2891.30.DA	523	09.2994.30	523	09.3812.06A	61	09.3843.14A	65
09.2452.02C	532	09.2866.14.DA	525	09.2892.14	523	09.2994.30.DA	523	09.3812.14A	61	09.3843.18A	65
09.2452.14C	532	09.2866.30	525	09.2892.14.DA	523	09.2995.14	523	09.3812.18A	61	09.3843.1AA	48
09.2452.30C	532	09.2866.30.DA	525	09.2892.30	523	09.2995.14.DA	523	09.3812.40A	61	09.3843.40A	48
09.2455.02B	534	09.2867.14	525	09.2892.30.DA	523	09.2995.30	523	09.3812.CZA	61	09.3843.40A	65
09.2455.14B	534	09.2867.14.DA	525	09.2893.14	523	09.2995.30.DA	523	09.3813.06A	61	09.3843.CZA	48
09.2455.30B	534	09.2867.30	525	09.2893.14.DA	523	09.2996.14	523	09.3813.14A	61	09.3843.CZA	65
09.2456.02B	534	09.2867.30.DA	525	09.2893.30	523	09.2996.14.DA	523	09.3813.18A	61	09.3850.06	65
09.2456.14B	534	09.2870.14	520	09.2893.30.DA	523	09.2996.30	523	09.3813.40A	61	09.3850.14	65
09.2456.30B	534	09.2870.14.DA	520	09.2894.14	521	09.2996.30.DA	523	09.3813.CZA	61	09.3850.18	65
09.2457.02B	534	09.2870.30	520	09.2894.14.DA	521	09.2997.14	522	09.3820.06A	63	09.3850.40	65
09.2457.14B	534	09.2870.30.DA	520	09.2894.30	521	09.2997.14.DA	522	09.3820.14A	63	09.3850.CZA	65
09.2457.30B	534	09.2871.14	520	09.2894.30.DA	521	09.2997.30	522	09.3820.18A	63	09.3851.06	65
09.2460.02C	532	09.2871.14.DA	520	09.2895.14	521	09.2997.30.DA	522	09.3820.40A	63	09.3851.14	65
09.2460.14C	532	09.2871.30	520	09.2895.14.DA	521	09.2998.14	522	09.3820.CZA	63	09.3851.18	65
09.2460.30C	532	09.2871.30.DA	520	09.2895.30	521	09.2998.14.DA	522	09.3821.06A	63	09.3851.40	65
09.2461.02C	532	09.2872.14	520	09.2895.30.DA	521	09.2998.30	522	09.3821.14A	63	09.3851.CZ	65
09.2461.14C	532	09.2872.14.DA	520	09.2896.14	521	09.2998.30.DA	522	09.3821.18A	63	09.3860.06A	62
09.2461.30C	532	09.2872.30	520	09.2896.14.DA	521	09.2999.14	522	09.3821.40A	63	09.3860.14A	62
09.2462.02C	532	09.2872.30.DA	520	09.2896.30	521	09.2999.14.DA	522	09.3821.CZA	63	09.3860.18A	62
09.2462.14C	532	09.2873.14	523	09.2896.30.DA	521	09.2999.30	522	09.3822.06A	63	09.3860.40A	62
09.2462.30C	532	09.2873.14.DA	523	09.2897.14	524	09.2999.30.DA	522	09.3822.14A	63	09.3860.CZA	62
09.2465.02B	534	09.2873.30	523	09.2897.14.DA	524	09.3200.29A	603	09.3822.18A	63	09.3861.06A	62
09.2465.14B	534	09.2873.30.DA	523	09.2897.30	524	09.3200.30A	603	09.3822.40A	63	09.3861.14A	62
09.2465.30B	534	09.2874.14	523	09.2897.30.DA	524	09.3200.55A	603	09.3822.CZA	63	09.3861.18A	62
09.2466.02B	534	09.2874.14.DA	523	09.2898.14	524	09.3200.ANA	603	09.3823.06A	63	09.3861.40A	62
09.2466.14B	534	09.2874.30	523	09.2898.14.DA	524	09.3200.BZA	603	09.3823.14A	63	09.3861.CZA	62
09.2466.30B	534	09.2874.30.DA	523	09.2898.30	524	09.3201.29A	603	09.3823.18A	63	09.3862.06A	62
09.2467.02B	534	09.2875.14	523	09.2898.30.DA	524	09.3201.30A	603	09.3823.40A	63	09.3862.14A	62
09.2467.14B	534	09.2875.14.DA	523	09.2899.14	524	09.3201.55A	603	09.3823.CZA	63	09.3862.18A	62
09.2467.30B	534	09.2875.30	523	09.2899.14.DA	524	09.3201.ANA	603	09.3830.06A	64	09.3862.40A	62
09.2470.02C	536	09.2875.30.DA	523	09.2899.30	524	09.3201.BZA	603	09.3830.14A	48	09.3862.CZA	62
09.2470.14C	536	09.2876.14	521	09.2899.30.DA	524	09.3310.01C	605	09.3830.14A	64	09.3863.06A	62
09.2470.30C	536	09.2876.14.DA	521	09.2953.14	520	09.3310.04C	605	09.3830.18A	64	09.3863.14A	62
09.2471.02C	536	09.2876.30	521	09.2953.14.DA	520	09.3310.72C	605	09.3830.1AA	48	09.3863.18A	62
09.2471.14C	536	09.2876.30.DA	521	09.2953.30	520	09.3707.06	498	09.3830.40A	48	09.3863.40A	62
09.2471.30C	536	09.2877.14	521	09.2953.30.DA	520	09.3707.14	498	09.3830.40A	64	09.3863.CZA	62
09.2472.02C	536	09.2877.14.DA	521	09.2954.14	520	09.3707.30	498	09.3830.CZA	48	09.3864.06A	62
09.2472.14C	536	09.2877.30	521	09.2954.14.DA	520	09.3708.06A	498	09.3830.CZA	64	09.3864.14A	62
09.2472.30C	536	09.2877.30.DA	521	09.2954.30	520	09.3708.14A	498	09.3831.06A	64	09.3864.18A	62
09.2475.02B	538	09.2878.14	521	09.2954.30.DA	520	09.3708.30A	498	09.3831.14A	48	09.3864.40A	62
09.2475.14B	538	09.2878.14.DA	521	09.2955.14	520	09.3710.06C	499	09.3831.14A	64	09.3864.CZA	62
09.2475.30B	538	09.2878.30	521	09.2955.14.DA	520	09.3710.14C	499	09.3831.18A	64	09.3865.06A	62
09.2476.02B	538	09.2878.30.DA	521	09.2955.30	520	09.3710.30C	499	09.3831.1AA	48	09.3865.14A	62
09.2476.14B	538	09.2879.14	524	09.2955.30.DA	520	09.3711.06C	499	09.3831.40A	48	09.3865.18A	62
09.2476.30B	538	09.2879.14.DA	524	09.2956.14	521	09.3711.14C	499	09.3831.40A	64	09.3865.40A	62
09.2477.02B	538	09.2879.30	524	09.2956.14.DA	521	09.3711.30C	499	09.3831.CZA	48	09.3865.CZA	62
09.2477.14B	538	09.2879.30.DA	524	09.2956.30	521	09.3750.06A	497	09.3831.CZA	64	09.3900.06A	60
09.2477.30B	538	09.2880.14	524	09.2956.30.DA	521	09.3750.14A	497	09.3832.06A	64	09.3900.14A	60
09.2480.02C	536	09.2880.14.DA	524	09.2957.14	521	09.3750.30A	497	09.3832.14A	48	09.3900.18A	60
09.2480.14C	536	09.2880.30	524	09.2957.14.DA	521	09.3751.06A	497	09.3832.14A	64	09.3900.40A	60
09.2480.30C	536	09.2880.30.DA	524	09.2957.30	521	09.3751.14A	497	09.3832.18A	64	09.3900.CZA	60
09.2481.02C	536	09.2881.14	524	09.2957.30.DA	521	09.3751.30A	497	09.3832.1AA	48	09.3901.06A	60
09.2481.14C	536	09.2881.14.DA	524	09.2958.14	521	09.3755.06A	497	09.3832.40A	48	09.3901.14A	60
09.2481.30C	536	09.2881.30	524	09.2958.14.DA	521	09.3755.14A	497	09.3832.40A	64	09.3901.18A	60
09.2482.02C	536	09.2881.30.DA	524	09.2958.30	521	09.3755.30A	497	09.3832.CZA	48	09.3901.40A	60
09.2482.14C	536	09.2882.14	525	09.2958.30.DA	521	09.3756.06A	497	09.3832.CZA	64	09.3901.CZA	60
09.2482.30C	536	09.2882.14.DA	525	09.2959.14	524	09.3756.14A	497	09.3833.06A	64	09.3902.06A	60
09.2485.02B	538	09.2882.30	525	09.2959.14.DA	524	09.3756.30A	497	09.3833.14A	48	09.3902.14A	60
09.2485.14B	538	09.2882.30.DA	525	09.2959.30	524	09.3780.06A	496	09.3833.14A	64	09.3902.18A	60
09.2485.30B	538	09.2883.14	525	09.2959.30.DA	524	09.3780.14A	496	09.3833.18A	64	09.3902.40A	60
09.2486.02B	538	09.2883.14.DA	525	09.2960.14	524	09.3780.30A	496	09.3833.1AA	48	09.3902.CZA	60
09.2486.14B	538	09.2883.30	525	09.2960.14.DA	524	09.3781.06A	496	09.3833.40A	48	09.3903.06A	60
09.2486.30B	538	09.2883.30.DA	525	09.2960.30	524	09.3781.14A	496	09.3833.40A	64	09.3903.14A	60
09.2487.02B	538	09.2884.14	525	09.2960.30.DA	524	09.3781.30A	496	09.3833.CZA	48	09.3903.18A	60
09.2487.14B	538	09.2884.14.DA	525	09.2961.14	524	09.3800.06A	60	09.3833.CZA	64	09.3903.40A	60
09.2487.30B	538	09.2884.30	525	09.2961.14.DA	524	09.3800.14A	60	09.3840.06A	65	09.3903.CZA	60
09.2570.02A	530	09.2884.30.DA	525	09.2961.30	524	09.3800.18A	60	09.3840.14A	48	09.3910.06A	61
09.2570.14A	530	09.2885.14	522	09.2961.30.DA	524	09.3800.40A	60	09.3840.14A	65	09.3910.14A	61
09.2570.30A	530	09.2885.14.DA	522	09.2962.14	525	09.3800.CZA	60	09.3840.18A	65	09.3910.18A	61
09.2571.02A	530	09.2885.30	522	09.2962.14.DA	525	09.3801.06A	60				

QUICK SEARCH OF PRODUCT

Ref.	Page	Ref.	Page	Ref.	Page	Ref.	Page	Ref.	Page	Ref.	Page
09.3913.06A	61	09.3951.14	65	09.4440.14ADA	510	09.4511.30A	422	09.4851.14ADA	511	09.4918.30A	424
09.3913.14A	61	09.3951.18	65	09.4440.30A	510	09.4511.30ADA	422	09.4851.30A	511	09.4918.30ADA	424
09.3913.18A	61	09.3951.40	65	09.4440.30ADA	510	09.4512.14A	422	09.4851.30ADA	511	09.4919.14A	425
09.3913.40A	61	09.3951.CZ	65	09.4441.14A	510	09.4512.14ADA	422	09.4852.14A	511	09.4919.14ADA	425
09.3913.CZA	61	09.3960.06A	62	09.4441.14ADA	510	09.4512.30A	422	09.4852.14ADA	511	09.4919.30A	425
09.3920.06A	63	09.3960.14A	62	09.4441.30A	510	09.4512.30ADA	422	09.4852.30A	511	09.4919.30ADA	425
09.3920.14A	63	09.3960.18A	62	09.4441.30ADA	510	09.4513.14A	422	09.4852.30ADA	511	09.4920.14A	425
09.3920.18A	63	09.3960.40A	62	09.4442.14A	510	09.4513.14ADA	422	09.4860.14A	504	09.4920.14ADA	425
09.3920.40A	63	09.3960.CZA	62	09.4442.14ADA	510	09.4513.30A	422	09.4860.14ADA	504	09.4920.30A	425
09.3920.CZA	63	09.3961.06A	62	09.4442.30A	510	09.4513.30ADA	422	09.4860.30A	504	09.4920.30ADA	425
09.3921.06A	63	09.3961.14A	62	09.4442.30ADA	510	09.4514.14A	422	09.4860.30ADA	504	09.4921.14A	425
09.3921.14A	63	09.3961.18A	62	09.4443.14A	510	09.4514.14ADA	422	09.4861.14A	504	09.4921.14ADA	425
09.3921.18A	63	09.3961.40A	62	09.4443.14ADA	510	09.4514.30A	422	09.4861.14ADA	504	09.4921.30A	425
09.3921.40A	63	09.3961.CZA	62	09.4443.30A	510	09.4514.30ADA	422	09.4861.30A	504	09.4921.30ADA	425
09.3921.CZA	63	09.3962.06A	62	09.4443.30ADA	510	09.4515.14A	422	09.4861.30ADA	504	09.4922.14A	425
09.3922.06A	63	09.3962.14A	62	09.4444.14A	510	09.4515.14ADA	422	09.4862.14A	504	09.4922.14ADA	425
09.3922.14A	63	09.3962.18A	62	09.4444.14ADA	510	09.4515.30A	422	09.4862.14ADA	504	09.4922.30A	425
09.3922.18A	63	09.3962.40A	62	09.4444.30A	510	09.4515.30ADA	422	09.4862.30A	504	09.4922.30ADA	425
09.3922.40A	63	09.3962.CZA	62	09.4444.30ADA	510	09.4516.14A	422	09.4862.30ADA	504	09.4923.14A	425
09.3922.CZA	63	09.3963.06A	62	09.4445.14A	510	09.4516.14ADA	422	09.4863.14A	504	09.4923.14ADA	425
09.3923.06A	63	09.3963.14A	62	09.4445.14ADA	510	09.4516.30A	422	09.4863.14ADA	504	09.4923.30A	425
09.3923.14A	63	09.3963.18A	62	09.4445.30A	510	09.4516.30ADA	422	09.4863.30A	504	09.4923.30ADA	425
09.3923.18A	63	09.3963.40A	62	09.4445.30ADA	510	09.4517.14A	422	09.4863.30ADA	504	09.4924.14A	425
09.3923.40A	63	09.3963.CZA	62	09.4450.14A	510	09.4517.14ADA	422	09.4864.14A	504	09.4924.14ADA	425
09.3923.CZA	63	09.3964.06A	62	09.4450.14ADA	510	09.4517.30A	422	09.4864.14ADA	504	09.4924.30A	425
09.3930.06A	64	09.3964.14A	62	09.4450.30A	510	09.4517.30ADA	422	09.4864.30A	504	09.4924.30ADA	425
09.3930.14A	48	09.3964.18A	62	09.4450.30ADA	510	09.4518.14A	422	09.4864.30ADA	504	09.4925.14A	425
09.3930.14A	64	09.3964.40A	62	09.4451.14A	510	09.4518.14ADA	422	09.4865.14A	504	09.4925.14ADA	425
09.3930.18A	64	09.3964.CZA	62	09.4451.14ADA	510	09.4518.30A	422	09.4865.14ADA	504	09.4925.30A	425
09.3930.40A	48	09.3965.06A	62	09.4451.30A	510	09.4518.30ADA	422	09.4865.30A	504	09.4925.30ADA	425
09.3930.40A	64	09.3965.14A	62	09.4451.30ADA	510	09.4519.14A	423	09.4865.30ADA	504	09.4926.14A	425
09.3930.CZA	48	09.3965.18A	62	09.4452.14A	510	09.4519.14ADA	423	09.4870.14A	504	09.4926.14ADA	425
09.3930.CZA	64	09.3965.40A	62	09.4452.14ADA	510	09.4519.30A	423	09.4870.14ADA	504	09.4926.30A	425
09.3931.06A	64	09.3965.CZA	62	09.4452.30A	510	09.4519.30ADA	423	09.4870.30A	504	09.4926.30ADA	425
09.3931.14A	48	09.4243.14	512	09.4452.30ADA	510	09.4520.14A	423	09.4870.30ADA	504	09.4927.14A	425
09.3931.14A	64	09.4243.14.DA	512	09.4460.14A	503	09.4520.14ADA	423	09.4871.14A	504	09.4927.14ADA	425
09.3931.18A	64	09.4243.30	512	09.4460.14ADA	503	09.4520.30A	423	09.4871.14ADA	504	09.4927.30A	425
09.3931.40A	48	09.4243.30.DA	512	09.4460.30A	503	09.4520.30ADA	423	09.4871.30A	504	09.4927.30ADA	425
09.3931.40A	64	09.4244.14A	512	09.4460.30ADA	503	09.4521.14A	423	09.4871.30ADA	504	09.4950.14A	513
09.3931.CZA	48	09.4244.14ADA	512	09.4461.14A	503	09.4521.14ADA	423	09.4872.14A	504	09.4950.14ADA	513
09.3931.CZA	64	09.4244.30A	512	09.4461.14ADA	503	09.4521.30A	423	09.4872.14ADA	504	09.4950.30A	513
09.3932.06A	64	09.4244.30ADA	512	09.4461.30A	503	09.4521.30ADA	423	09.4872.30A	504	09.4950.30ADA	513
09.3932.14A	48	09.4245.14	512	09.4461.30ADA	503	09.4522.14A	423	09.4872.30ADA	504	09.4951.14A	513
09.3932.14A	64	09.4245.14.DA	512	09.4462.14A	503	09.4522.14ADA	423	09.4880.14A	511	09.4951.30A	513
09.3932.18A	64	09.4245.30	512	09.4462.14ADA	503	09.4522.30A	423	09.4880.30A	511	09.4953.14A	513
09.3932.40A	48	09.4245.30.DA	512	09.4462.30A	503	09.4522.30ADA	423	09.4881.14A	511	09.4953.14ADA	513
09.3932.40A	64	09.4250.14	512	09.4462.30ADA	503	09.4523.14A	423	09.4881.30A	511	09.4953.30A	513
09.3932.CZA	48	09.4250.14.DA	512	09.4463.14A	503	09.4523.14ADA	423	09.4882.14A	511	09.4953.30ADA	513
09.3932.CZA	64	09.4250.30	512	09.4463.14ADA	503	09.4523.30A	423	09.4882.30A	511	09.4954.14A	513
09.3933.06A	64	09.4250.30.DA	512	09.4463.30A	503	09.4523.30ADA	423	09.4883.14A	511	09.4954.30A	513
09.3933.14A	48	09.4251.14A	512	09.4463.30ADA	503	09.4524.14A	423	09.4883.30A	511	09.4956.14A	513
09.3933.14A	64	09.4251.14ADA	512	09.4464.14A	503	09.4524.14ADA	423	09.4884.14A	511	09.4956.14ADA	513
09.3933.18A	64	09.4251.30A	512	09.4464.14ADA	503	09.4524.30A	423	09.4884.30A	511	09.4956.30A	513
09.3933.40A	48	09.4251.30ADA	512	09.4464.30A	503	09.4524.30ADA	423	09.4885.14A	511	09.4956.30ADA	513
09.3933.40A	64	09.4252.14	512	09.4464.30ADA	503	09.4525.14A	423	09.4885.30A	511	09.4957.14A	513
09.3933.CZA	48	09.4252.14.DA	512	09.4465.14A	503	09.4525.14ADA	423	09.4886.14A	511	09.4957.30A	513
09.3933.CZA	64	09.4252.30	512	09.4465.14ADA	503	09.4525.30A	423	09.4886.30A	511	09.4980.14	513
09.3940.06A	65	09.4252.30.DA	512	09.4465.30A	503	09.4525.30ADA	423	09.4887.14A	511	09.4980.14.DA	513
09.3940.14A	48	09.4263.14	505	09.4465.30ADA	503	09.4526.14A	423	09.4887.30A	511	09.4980.30	513
09.3940.14A	65	09.4263.14.DA	505	09.4470.14A	503	09.4526.14ADA	423	09.4888.14A	511	09.4980.30.DA	513
09.3940.18A	65	09.4263.30	505	09.4470.14ADA	503	09.4526.30A	423	09.4888.30A	511	09.4981.14	513
09.3940.40A	48	09.4263.30.DA	505	09.4470.30A	503	09.4526.30ADA	423	09.4910.14A	424	09.4981.14.DA	513
09.3940.40A	65	09.4264.14A	505	09.4470.30ADA	503	09.4527.14A	423	09.4910.14ADA	424	09.4981.30	513
09.3940.CZA	48	09.4264.14ADA	505	09.4471.14A	503	09.4527.14ADA	423	09.4910.30A	424	09.4981.30.DA	513
09.3940.CZA	65	09.4264.30A	505	09.4471.14ADA	503	09.4527.30A	423	09.4910.30ADA	424	09.4982.14	513
09.3941.06A	65	09.4264.30ADA	505	09.4471.30A	503	09.4527.30ADA	423	09.4911.14A	424	09.4982.14.DA	513
09.3941.14A	48	09.4265.14	505	09.4471.30ADA	503	09.4840.14A	511	09.4911.14ADA	424	09.4982.30	513
09.3941.14A	65	09.4265.14.DA	505	09.4472.14A	503	09.4840.14ADA	511	09.4911.30A	424	09.4982.30.DA	513
09.3941.18A	65	09.4265.30	505	09.4472.14ADA	503	09.4840.30A	511	09.4911.30ADA	424	09.4983.14	513
09.3941.40A	48	09.4265.30.DA	505	09.4472.30A	503	09.4840.30ADA	511	09.4912.14A	424	09.4983.30	513
09.3941.40A	65	09.4270.14	505	09.4472.30ADA	503	09.4841.14A	511	09.4912.14ADA	424	09.4984.14	513
09.3941.CZA	48	09.4270.14.DA	505	09.4480.14A	510	09.4841.14ADA	511	09.4912.30A	424	09.4984.30	513
09.3941.CZA	65	09.4270.30	505	09.4480.30A	510	09.4841.30A	511	09.4912.30ADA	424	09.4985.14	513
09.3942.06A	65	09.4270.30.DA	505	09.4481.14A	510	09.4841.30ADA	511	09.4913.14A	424	09.4985.30	513
09.3942.14A	48	09.4271.14A	505	09.4481.30A	510	09.4842.14A	511	09.4913.14ADA	424	09.5010.02B	583
09.3942.14A	65	09.4271.14ADA	505	09.4482.14A	510	09.4842.14ADA	511	09.4913.30A	424	09.5010.02BDA	583
09.3942.18A	65	09.4271.30A	505	09.4482.30A	510	09.4842.30A	511	09.4913.30ADA	424	09.5010.14B	583
09.3942.40A	48	09.4271.30ADA	505	09.4483.14A	510	09.4842.30ADA	511	09.4914.14A	424	09.5010.14BDA	583
09.3942.40A	65	09.4272.14	505	09.4483.30A	510	09.4843.14A	511	09.4914.14ADA	424	09.5010.30B	583
09.3942.CZA	48	09.4272.14.DA	505	09.4484.14A	510	09.4843.14ADA	511	09.4914.30A	424	09.5010.30BDA	583
09.3942.CZA	65	09.4272.30	505	09.4484.30A	510	09.4843.30A	511	09.4914.30ADA	424	09.5011.02B	583
09.3943.06A	65	09.4272.30.DA	505	09.4485.14A	510	09.4843.30ADA	511	09.4915.14A	424	09.5011.02BDA	583
09.3943.14A	48	09.4281.14	512	09.4485.30A	510	09.4844.14A	511	09.4915.14ADA	424	09.5011.14B	583
09											

QUICK SEARCH OF PRODUCT

Ref.	Page	Ref.	Page	Ref.	Page	Ref.	Page	Ref.	Page	Ref.	Page
09.5016.14BDA	583	09.7212.40A78	137	09.7301.40	138	09.7370.14	139	09.7706.30A	506	09.7757.14ADA	507
09.5016.30B	583	09.7213.14A	137	09.7301.40.78	138	09.7370.40	139	09.7706.30A78	506	09.7757.30A	507
09.5016.30BDA	583	09.7213.40A	137	09.7302.14	138	09.7370.40.78	139	09.7706.30ADA	506	09.7757.30A78	507
09.5020.02B	584	09.7213.40A78	137	09.7302.40	138	09.7371.14	139	09.7706.30AYU	506	09.7757.30ADA	507
09.5020.02BDA	584	09.7214.14A	137	09.7302.40.78	138	09.7371.40	139	09.7707.14A	506	09.7757.30AYU	507
09.5020.14B	584	09.7214.40A	137	09.7303.14	138	09.7371.40.78	139	09.7707.14ADA	506	09.7758.14A	507
09.5020.14BDA	584	09.7214.40A78	137	09.7303.40	138	09.7372.14	139	09.7707.30A	506	09.7758.14ADA	507
09.5020.30B	584	09.7215.14A	137	09.7303.40.78	138	09.7372.40	139	09.7707.30A78	506	09.7758.30A	507
09.5020.30BDA	584	09.7215.40A	137	09.7304.14	138	09.7372.40.78	139	09.7707.30ADA	506	09.7758.30A78	507
09.5021.02B	584	09.7215.40A78	137	09.7304.40	138	09.7373.14	142	09.7707.30AYU	506	09.7758.30ADA	507
09.5021.02BDA	584	09.7216.14A	137	09.7304.40.78	138	09.7373.14	516	09.7708.14A	506	09.7758.30AYU	507
09.5021.14B	584	09.7216.40A	137	09.7305.14	138	09.7373.40	142	09.7708.14ADA	506	09.7770.14A	509
09.5021.14BDA	584	09.7216.40A78	137	09.7305.40	138	09.7373.40	516	09.7708.30A	506	09.7770.14ADA	509
09.5021.30B	584	09.7217.14A	137	09.7305.40.78	138	09.7373.40.78	142	09.7708.30A78	506	09.7770.30A	509
09.5021.30BDA	584	09.7217.40A	137	09.7306.14	138	09.7373.40.78	516	09.7708.30ADA	506	09.7770.30A78	509
09.5025.02B	584	09.7217.40A78	137	09.7306.40	138	09.7374.14	142	09.7708.30AYU	506	09.7770.30ADA	509
09.5025.02BDA	584	09.7218.14A	137	09.7306.40.78	138	09.7374.14	516	09.7730.14	508	09.7770.30AYU	509
09.5025.14B	584	09.7218.40A	137	09.7307.14	138	09.7374.40	142	09.7730.14.DA	508	09.7771.14A	509
09.5025.14BDA	584	09.7218.40A78	137	09.7307.40	138	09.7374.40	516	09.7730.30	508	09.7771.14ADA	509
09.5025.30B	584	09.7270.14A	140	09.7307.40.78	138	09.7374.40.78	142	09.7730.30.78	508	09.7771.30A	509
09.5025.30BDA	584	09.7270.14A	514	09.7308.14	138	09.7374.40.78	516	09.7730.30.DA	508	09.7771.30A78	509
09.5026.02B	584	09.7270.40A	140	09.7308.40	138	09.7375.14	142	09.7730.30.YU	508	09.7771.30ADA	509
09.5026.02BDA	584	09.7270.40A	514	09.7308.40.78	138	09.7375.14	516	09.7731.14A	508	09.7771.30AYU	509
09.5026.14B	584	09.7270.40A78	140	09.7310.14	141	09.7375.40	142	09.7731.14ADA	508	09.7772.14A	509
09.5026.14BDA	584	09.7270.40A78	514	09.7310.14	515	09.7375.40	516	09.7731.30A	508	09.7772.14ADA	509
09.5026.30B	584	09.7271.14A	140	09.7310.40	141	09.7375.40.78	142	09.7731.30A78	508	09.7772.30A	509
09.5026.30BDA	584	09.7271.14A	514	09.7310.40	515	09.7375.40.78	516	09.7731.30ADA	508	09.7772.30A78	509
09.5040.02B	585	09.7271.40A	140	09.7310.40.78	141	09.7500.14	139	09.7731.30AYU	508	09.7772.30ADA	509
09.5040.02BDA	585	09.7271.40A	514	09.7310.40.78	515	09.7500.40	139	09.7732.14	508	09.7772.30AYU	509
09.5040.14B	585	09.7271.40A78	140	09.7311.14	141	09.7500.40.78	139	09.7732.14.DA	508	09.8000.14	44
09.5040.14BDA	585	09.7271.40A78	514	09.7311.14	515	09.7501.14	139	09.7732.30	508	09.8000.1A	44
09.5040.30B	585	09.7272.14A	140	09.7311.40	141	09.7501.40	139	09.7732.30.78	508	09.8000.40	44
09.5040.30BDA	585	09.7272.14A	514	09.7311.40	515	09.7501.40.78	139	09.7732.30.DA	508	09.8000.CZ	44
09.5041.02B	585	09.7272.40A	140	09.7311.40.78	141	09.7504.14	142	09.7732.30.YU	508	09.8001.14	44
09.5041.02BDA	585	09.7272.40A	514	09.7311.40.78	515	09.7504.14	516	09.7733.14	508	09.8001.1A	44
09.5041.14B	585	09.7272.40A78	140	09.7312.14	141	09.7504.14.DA	142	09.7733.14.DA	508	09.8001.40	44
09.5041.14BDA	585	09.7272.40A78	514	09.7312.14	515	09.7504.14.DA	516	09.7733.30A	508	09.8001.CZ	44
09.5041.30B	585	09.7273.14A	140	09.7312.40	141	09.7504.40	142	09.7733.30.78	508	09.8002.14	44
09.5041.30BDA	585	09.7273.14A	514	09.7312.40	515	09.7504.40	516	09.7733.30.DA	508	09.8002.1A	44
09.5045.02B	585	09.7273.40A	140	09.7312.40.78	141	09.7504.40.78	142	09.7733.30.YU	508	09.8002.40	44
09.5045.02BDA	585	09.7273.40A	514	09.7312.40.78	515	09.7504.40.78	516	09.7734.14A	508	09.8002.CZ	44
09.5045.14B	585	09.7273.40A78	140	09.7313.14	141	09.7504.40.DA	142	09.7734.14ADA	508	09.8003.14	44
09.5045.14BDA	585	09.7273.40A78	514	09.7313.14	515	09.7504.40.DA	516	09.7734.30A	508	09.8003.1A	44
09.5045.30B	585	09.7274.14A	140	09.7313.40	141	09.7504.40.YU	142	09.7734.30A78	508	09.8003.40	44
09.5045.30BDA	585	09.7274.14A	514	09.7313.40	515	09.7504.40.YU	516	09.7734.30ADA	508	09.8003.CZ	44
09.5046.02B	585	09.7274.40A	140	09.7313.40.78	141	09.7505.14	142	09.7734.30AYU	508	09.8004.14	44
09.5046.02BDA	585	09.7274.40A	514	09.7313.40.78	515	09.7505.14	516	09.7735.14	508	09.8004.1A	44
09.5046.14B	585	09.7274.40A78	140	09.7314.14	141	09.7505.14.DA	142	09.7735.14.DA	508	09.8004.40	44
09.5046.14BDA	585	09.7274.40A78	514	09.7314.14	515	09.7505.14.DA	516	09.7735.30	508	09.8004.CZ	44
09.5046.30B	585	09.7275.14A	140	09.7314.40	141	09.7505.40	142	09.7735.30.78	508	09.8005.14	44
09.5046.30BDA	585	09.7275.14A	514	09.7314.40	515	09.7505.40	516	09.7735.30.DA	508	09.8005.1A	44
09.6010.02B	586	09.7275.40A	140	09.7314.40.78	141	09.7505.40.78	142	09.7735.30.YU	508	09.8005.40	44
09.6010.02BDA	586	09.7275.40A	514	09.7314.40.78	515	09.7505.40.78	516	09.7750.14A	507	09.8005.CZ	44
09.6010.14B	586	09.7275.40A78	140	09.7315.14	141	09.7505.40.DA	142	09.7750.14ADA	507	09.8006.14	44
09.6010.14BDA	586	09.7275.40A78	514	09.7315.14	515	09.7505.40.DA	516	09.7750.30A	507	09.8006.1A	44
09.6010.30B	586	09.7276.14A	140	09.7315.40	141	09.7505.40.YU	142	09.7750.30A78	507	09.8006.40	44
09.6010.30BDA	586	09.7276.14A	514	09.7315.40	515	09.7505.40.YU	516	09.7750.30ADA	507	09.8006.CZ	44
09.6011.02B	586	09.7276.40A	140	09.7315.40.78	141	09.7700.14A	506	09.7750.30AYU	507	09.8007.14	44
09.6011.02BDA	586	09.7276.40A	514	09.7315.40.78	515	09.7700.14ADA	506	09.7751.14A	507	09.8007.1A	44
09.6011.14B	586	09.7276.40A78	140	09.7316.14	141	09.7700.30A	506	09.7751.14ADA	507	09.8007.40	44
09.6011.14BDA	586	09.7276.40A78	514	09.7316.14	515	09.7700.30A78	506	09.7751.30A	507	09.8007.CZ	44
09.6011.30B	586	09.7277.14A	140	09.7316.40	141	09.7700.30ADA	506	09.7751.30A78	507	09.8010.14	45
09.6011.30BDA	586	09.7277.14A	514	09.7316.40	515	09.7700.30AYU	506	09.7751.30ADA	507	09.8010.1A	45
09.6020.02B	586	09.7277.40A	140	09.7316.40.78	141	09.7701.14A	506	09.7751.30AYU	507	09.8010.40	45
09.6020.02BDA	586	09.7277.40A	514	09.7316.40.78	515	09.7701.14ADA	506	09.7752.14A	507	09.8010.CZ	45
09.6020.14B	586	09.7277.40A78	140	09.7317.14	141	09.7701.30A	506	09.7752.14ADA	507	09.8011.14	45
09.6020.14BDA	586	09.7277.40A78	514	09.7317.14	515	09.7701.30A78	506	09.7752.30A	507	09.8011.1A	45
09.6020.30B	586	09.7278.14A	140	09.7317.40	141	09.7701.30ADA	506	09.7752.30A78	507	09.8011.40	45
09.6020.30BDA	586	09.7278.14A	514	09.7317.40	515	09.7701.30AYU	506	09.7752.30ADA	507	09.8011.CZ	45
09.6021.02B	586	09.7278.40A	140	09.7317.40.78	141	09.7702.14A	506	09.7752.30AYU	507	09.8012.14	45
09.6021.02BDA	586	09.7278.40A	514	09.7317.40.78	515	09.7702.14ADA	506	09.7753.14A	507	09.8012.1A	45
09.6021.14B	586	09.7278.40A78	140	09.7318.14	141	09.7702.30A	506	09.7753.14ADA	507	09.8012.40	45
09.6021.14BDA	586	09.7278.40A78	514	09.7318.14	515	09.7702.30A78	506	09.7753.30A	507	09.8012.CZ	45
09.6021.30B	586	09.7290.14A	557	09.7318.40	141	09.7702.30ADA	506	09.7753.30A78	507	09.8013.14	45
09.6021.30BDA	586	09.7290.40A	557	09.7318.40	515	09.7702.30AYU	506	09.7753.30ADA	507	09.8013.1A	45
09.6040.02B	587	09.7291.14A	557	09.7318.40.78	141	09.7703.14A	506	09.7753.30AYU	507	09.8013.40	45
09.6040.02BDA	587	09.7291.40A	557	09.7318.40.78	515	09.7703.14ADA	506	09.7754.14A	507	09.8013.CZ	45
09.6040.14B	587	09.7292.14A	557	09.7320.14	558	09.7703.30A	506	09.7754.14ADA	507	09.8014.14	45
09.6040.14BDA	587	09.7292.40A	557	09.7320.40	558	09.7703.30A78	506	09.7754.30A	507	09.8014.1A	45
09.6040.30B	587	09.7293.14A	557	09.7321.14	558	09.7703.30ADA	506	09.7754.30A78	507	09.8014.40	45
09.6040.30BDA	587	09.7293.40A	557	09.7321.40	558	09.7703.30AYU	506	09.7754.30ADA	507	09.8014.CZ	45
09.6041.02B	587	09.7294.14A	557	09.7322.14	558	09					

QUICK SEARCH OF PRODUCT

Ref.	Page	Ref.	Page	Ref.	Page	Ref.	Page	Ref.	Page	Ref.	Page
09.8020.40	46	09.8105.WA	488	09.8118.WA	490	09.8212.WA.PC	492	09.8300.DV	181	60.3036.29	608
09.8020.CZ	46	09.8105.WA.CB	488	09.8118.WA.CB	490	09.8213.DR	492	09.8300.DW	181	60.3036.29ADA	608
09.8021.14	46	09.8105.WA.PC	488	09.8118.WA.DA	490	09.8213.DR.CB	492	09.8300.DX	181	60.3037.11	608
09.8021.1A	46	09.8106.DR	488	09.8118.WA.PC	490	09.8213.DR.DA	492	09.8300.DY	181	60.3037.11ADA	608
09.8021.40	46	09.8106.DR.CB	488	09.8119.DR	491	09.8213.DR.PC	492	09.8301.AH	181	60.3037.14	608
09.8021.CZ	46	09.8106.DR.PC	488	09.8119.DR.CB	491	09.8213.WA	492	09.8301.DR	181	60.3037.14ADA	608
09.8022.14	46	09.8106.WA	488	09.8119.DR.DA	491	09.8213.WA.CB	492	09.8301.DV	181	60.3037.29	608
09.8022.1A	46	09.8106.WA.CB	488	09.8119.DR.PC	491	09.8213.WA.DA	492	09.8301.DW	181	60.3037.29ADA	608
09.8022.40	46	09.8106.WA.PC	488	09.8119.WA	491	09.8213.WA.PC	492	09.8301.DX	181	60.3038.11	607
09.8022.CZ	46	09.8107.DR	488	09.8119.WA.CB	491	09.8214.DR	493	09.8301.DY	181	60.3038.11ADA	607
09.8023.14	46	09.8107.DR.CB	488	09.8119.WA.DA	491	09.8214.DR.CB	493	09.8302.AH	181	60.3038.12	607
09.8023.1A	46	09.8107.DR.PC	488	09.8119.WA.PC	491	09.8214.DR.DA	493	09.8302.DR	181	60.3038.12ADA	607
09.8023.40	46	09.8107.WA	488	09.8200.DR	489	09.8214.DR.PC	493	09.8302.DV	181	60.3038.14	607
09.8023.CZ	46	09.8107.WA.CB	488	09.8200.DR.CB	489	09.8214.WA	493	09.8302.DW	181	60.3038.14ADA	607
09.8024.14	46	09.8107.WA.PC	488	09.8200.DR.PC	489	09.8214.WA.CB	493	09.8302.DX	181	60.3039.11	607
09.8024.1A	46	09.8108.DR	488	09.8200.WA	489	09.8214.WA.DA	493	09.8302.DY	181	60.3039.11ADA	607
09.8024.40	46	09.8108.DR.CB	488	09.8200.WA.CB	489	09.8214.WA.PC	493	09.8310.AH	181	60.3039.12	607
09.8024.CZ	46	09.8108.DR.PC	488	09.8200.WA.PC	489	09.8215.DR	492	09.8310.DR	181	60.3039.12ADA	607
09.8025.14	46	09.8108.WA	488	09.8201.DR	489	09.8215.DR.CB	492	09.8310.DV	181	60.3039.14	607
09.8025.1A	46	09.8108.WA.CB	488	09.8201.DR.CB	489	09.8215.DR.DA	492	09.8310.DW	181	60.3039.14ADA	607
09.8025.40	46	09.8108.WA.PC	488	09.8201.DR.PC	489	09.8215.DR.PC	492	09.8310.DX	181	60.3043.11	608
09.8025.CZ	46	09.8109.DR	488	09.8201.WA	489	09.8215.WA	492	09.8310.DY	181	60.3043.11ADA	608
09.8026.14	46	09.8109.DR.CB	488	09.8201.WA.CB	489	09.8215.WA.CB	492	09.8311.AH	181	60.3043.14	608
09.8026.1A	46	09.8109.DR.PC	488	09.8201.WA.PC	489	09.8215.WA.DA	492	09.8311.DR	181	60.3043.14ADA	608
09.8026.40	46	09.8109.WA	488	09.8202.DR	489	09.8215.WA.PC	492	09.8311.DV	181	60.3043.29	608
09.8026.CZ	46	09.8109.WA.CB	488	09.8202.DR.CB	489	09.8216.DR	492	09.8311.DW	181	60.3043.29ADA	608
09.8027.14	46	09.8109.WA.PC	488	09.8202.DR.PC	489	09.8216.DR.CB	492	09.8311.DX	181	60.3044.11	608
09.8027.1A	46	09.8110.DR	490	09.8202.WA	489	09.8216.DR.DA	492	09.8311.DY	181	60.3044.11ADA	608
09.8027.40	46	09.8110.DR.CB	490	09.8202.WA.CB	489	09.8216.DR.PC	492	09.8312.AH	181	60.3044.12	608
09.8027.CZ	46	09.8110.DR.DA	490	09.8202.WA.PC	489	09.8216.WA	492	09.8312.DR	181	60.3044.12ADA	608
09.8030.14	47	09.8110.DR.PC	490	09.8203.DR	489	09.8216.WA.CB	492	09.8312.DV	181	60.3044.14	608
09.8030.1A	47	09.8110.WA	490	09.8203.DR.CB	489	09.8216.WA.DA	492	09.8312.DW	181	60.3044.14ADA	608
09.8030.40	47	09.8110.WA.CB	490	09.8203.DR.PC	489	09.8216.WA.PC	492	09.8312.DX	181	60.3046.11	608
09.8030.CZ	47	09.8110.WA.DA	490	09.8203.WA	489	09.8217.DR	492	09.8312.DY	181	60.3046.14	608
09.8031.14	47	09.8110.WA.PC	490	09.8203.WA.CB	489	09.8217.DR.CB	492	09.9070.14	151	60.3046.29	608
09.8031.1A	47	09.8111.DR	490	09.8203.WA.PC	489	09.8217.DR.DA	492	09.9070.BW	151	60.3047.11	608
09.8031.40	47	09.8111.DR.CB	490	09.8204.DR	489	09.8217.DR.PC	492	09.9071.14	151	60.3047.11ADA	608
09.8031.CZ	47	09.8111.DR.DA	490	09.8204.DR.CB	489	09.8217.WA	492	09.9071.BW	151	60.3047.14	608
09.8032.14	47	09.8111.DR.PC	490	09.8204.DR.PC	489	09.8217.WA.CB	492	09.9072.14	151	60.3047.14ADA	608
09.8032.1A	47	09.8111.WA	490	09.8204.WA	489	09.8217.WA.DA	492	09.9072.BW	151	60.3047.29	608
09.8032.40	47	09.8111.WA.CB	490	09.8204.WA.CB	489	09.8217.WA.PC	492	09.9075.14	151	60.3047.29ADA	608
09.8032.CZ	47	09.8111.WA.DA	490	09.8204.WA.PC	489	09.8218.DR	492	09.9075.BW	151	60.3048.11	608
09.8033.14	47	09.8111.WA.PC	490	09.8205.DR	489	09.8218.DR.CB	492	09.9076.14	151	60.3048.11ADA	608
09.8033.1A	47	09.8112.DR	490	09.8205.DR.CB	489	09.8218.DR.DA	492	09.9076.BW	151	60.3048.14	608
09.8033.40	47	09.8112.DR.CB	490	09.8205.DR.PC	489	09.8218.DR.PC	492	09.9077.14	151	60.3048.14ADA	608
09.8033.CZ	47	09.8112.DR.DA	490	09.8205.WA	489	09.8218.WA	492	09.9077.BW	151	60.3048.29	608
09.8034.14	47	09.8112.DR.PC	490	09.8205.WA.CB	489	09.8218.WA.CB	492	09.9083.14	152	60.3048.29ADA	608
09.8034.1A	47	09.8112.WA	490	09.8205.WA.PC	489	09.8218.WA.DA	492	09.9083.BW	152	60.3049.11	608
09.8034.40	47	09.8112.WA.CB	490	09.8206.DR	489	09.8218.WA.PC	492	09.9084.14	152	60.3049.14	608
09.8034.CZ	47	09.8112.WA.DA	490	09.8206.DR.CB	489	09.8219.DR	493	09.9084.BW	152	60.3049.29	608
09.8035.14	47	09.8112.WA.PC	490	09.8206.DR.PC	489	09.8219.DR.CB	493	09.9085.14	152	60.3051.11	608
09.8035.1A	47	09.8113.DR	490	09.8206.WA	489	09.8219.DR.DA	493	09.9085.BW	152	60.3051.14	608
09.8035.40	47	09.8113.DR.CB	490	09.8206.WA.CB	489	09.8219.DR.PC	493	09.9086.14	152	60.3051.29	608
09.8035.CZ	47	09.8113.DR.DA	490	09.8206.WA.PC	489	09.8219.WA	493	09.9086.BW	152	60.3053.11	607
09.8036.14	47	09.8113.DR.PC	490	09.8207.DR	489	09.8219.WA.CB	493	09.9087.14	152	60.3053.14	607
09.8036.1A	47	09.8113.WA	490	09.8207.DR.CB	489	09.8219.WA.DA	493	09.9087.BW	152	60.3054	608
09.8036.40	47	09.8113.WA.CB	490	09.8207.DR.PC	489	09.8219.WA.PC	493	09.9088.14	152	60.3057.11	607
09.8036.CZ	47	09.8113.WA.DA	490	09.8207.WA	489	09.8220.AH	179	09.9088.BW	152	60.3057.29	607
09.8037.14	47	09.8113.WA.PC	490	09.8207.WA.CB	489	09.8220.DR	179	60.3008.11	607	60.3083.29	607
09.8037.1A	47	09.8114.DR	491	09.8207.WA.PC	489	09.8220.DV	179	60.3008.14	607	60.3090.11	607
09.8037.40	47	09.8114.DR.CB	491	09.8208.DR	489	09.8220.DW	179	60.3014.11	115	60.3091.11	607
09.8037.CZ	47	09.8114.DR.DA	491	09.8208.DR.CB	489	09.8220.DX	179	60.3014.11	117	60.3091.14	607
09.8100.DR	488	09.8114.DR.PC	491	09.8208.DR.PC	489	09.8220.DY	179	60.3014.11	607	60.3092.11	607
09.8100.DR.CB	488	09.8114.WA	491	09.8208.WA	489	09.8221.AH	179	60.3014.14	115	60.3093.29	607
09.8100.DR.PC	488	09.8114.WA.CB	491	09.8208.WA.CB	489	09.8221.DR	179	60.3014.14	117	60.3094.11	607
09.8100.WA	488	09.8114.WA.DA	491	09.8208.WA.PC	489	09.8221.DV	179	60.3014.14	607	60.3094.14	607
09.8100.WA.CB	488	09.8114.WA.PC	491	09.8209.DR	489	09.8221.DW	179	60.3016.11	608	60.3095.29	607
09.8100.WA.PC	488	09.8115.DR	490	09.8209.DR.CB	489	09.8221.DX	179	60.3016.12	608	60.3096.29	607
09.8101.DR	488	09.8115.DR.CB	490	09.8209.DR.PC	489	09.8221.DY	179	60.3016.14	608	60.3097.11	115
09.8101.DR.CB	488	09.8115.DR.DA	490	09.8209.WA	489	09.8222.AH	179	60.3018.11	607	60.3097.11	117
09.8101.DR.PC	488	09.8115.DR.PC	490	09.8209.WA.CB	489	09.8222.DR	179	60.3018.14	607	60.3097.11	148
09.8101.WA	488	09.8115.WA	490	09.8209.WA.PC	489	09.8222.DV	179	60.3022.11	608	60.3097.11	607
09.8101.WA.CB	488	09.8115.WA.CB	490	09.8210.DR	492	09.8222.DW	179	60.3022.14	608	60.3097.14	115
09.8101.WA.PC	488	09.8115.WA.DA	490	09.8210.DR.CB	492	09.8222.DX	179	60.3023.11	608	60.3097.14	117
09.8102.DR	488	09.8115.WA.PC	490	09.8210.DR.DA	492	09.8222.DY	179	60.3023.14	608	60.3097.14	148
09.8102.DR.CB	488	09.8116.DR	490	09.8210.DR.PC	492	09.8230.AH	179	60.3023.29	608	60.3097.14	607
09.8102.DR.PC	488	09.8116.DR.CB	490	09.8210.WA	492	09.8230.DR	179	60.3025.11	607	60.3101.11	606
09.8102.WA	488	09.8116.DR.DA	490	09.8210.WA.CB	492	09.8230.DV	179	60.3025.14	607	60.3101.11ADA	606
09.8102.WA.CB	488	09.8116.DR.PC	490	09.8210.WA.DA	492	09.8230.DW	179	60.3025.29	607	60.3101.14	606
09.8102.WA.PC	488	09.8116.WA	490	09.8210.WA.PC	492	09.8230.DX	179	60.3028.11	608	60.3101.14ADA	606
09.8103.DR	488	09.8116.WA.CB	490	09.8211.DR	492	09.8230.DY	179	60.3028.11ADA	608	60.3101.29	606
09.8103.DR.CB	488	09.8116.WA.DA	490	09.8211.DR.CB	492	09.8231.AH	179	60.3028.14	608	60.3101.29ADA	606
09.8103.DR.PC	488	09.8116.WA.PC	490	09.8211.DR.DA	492	09.8231.DR	179	60.3028.14ADA	608	60.3102.11	606
09.8103.WA	488	09.8117.DR	490	09.8211.DR.PC	492	09.8231.DV	179	60.3028.29	608	60.3102.11ADA	606
09.8103.WA.CB	488	09.8117.DR.CB	490	09.8211.WA	492	09.8231.DW	179	60.3028.29ADA	608	60.3102.14	606
09.8103.WA.PC	488	09.8117.DR.DA	490	09.8211.WA.CB	492	09					

QUICK SEARCH OF PRODUCT

Ref.	Page	Ref.	Page	Ref.	Page	Ref.	Page	Ref.	Page	Ref.	Page
60.3104.11ADA	606	60.8311	616	F4185009	600	SA.1008.5D110	663	SA.2333.3.120	633	SA.5063.3.OOG	655
60.3104.14	606	60.8364	616	F4185030	600	SA.1008.6D100	663	SA.2334.1	633	SA.5063.3.OV3	655
60.3104.14ADA	606	60.8402	655	F4185057	600	SA.1009.4.11V	663	SA.2334.3.120	633	SA.5064.3.076	655
60.3104.29	606	60.8407	289	F9463009	601	SA.1009.4.1DA	663	SA.2343.1	633	SA.5064.3.OOG	655
60.3104.29ADA	606	60.8437	612	F9463030	601	SA.1009.4.200	663	SA.2343.3.120	633	SA.5064.3.OV3	655
60.3145.11	607	60.8515	616	F9463057	601	SA.1009.4.21V	663	SA.2343.3.140	633	SA.5065.3.076	655
60.3145.14	607	60.8529	614	F9466057	599	SA.1009.4.2DA	663	SA.2343.3.160	633	SA.5065.3.OOG	655
60.3146.11	607	60.8530	612	F9467057	599	SA.1009.4.300	663	SA.2344.1	633	SA.5065.3.OV3	655
60.3146.14	607	60.8533	612	F9474057	600	SA.1009.5D110	663	SA.2344.3.120	633	SA.5066.3.076	655
60.3317.11A	135	60.8534	614	F9477057	600	SA.1009.6D100	663	SA.2344.3.140	633	SA.5066.3.OOG	655
60.3317.14	135	60.8640	168	F9478009	601	SA.1010.4.100	664	SA.2344.3.160	633	SA.5066.3.OV3	655
60.3318.11A	135	60.8640	289	F9478030	601	SA.1010.4.200	664	SA.2423.5A145	631	SA.5067.3.076	655
60.3318.14	135	60.8640	595	F9478057	601	SA.1010.4.300	664	SA.2423.5A165	631	SA.5067.3.OOG	655
60.3319.11A	135	60.8650	612	F9492057	598	SA.1010.5D110	664	SA.2424.5A145	631	SA.5067.3.OV3	655
60.3319.14	134	60.8655	612	F9493057	598	SA.1010.6D100	664	SA.2424.5A165	631	SA.5068.3.076	655
60.3319.14	135	60.8670	612	F9494057	598	SA.1011.4.11V	664	SA.2453.5A145	631	SA.5068.3.OOG	655
60.3320.11A	135	60.8703	616	F9497057	599	SA.1011.4.1DA	664	SA.2453.5A165	631	SA.5068.3.OV3	655
60.3320.14	135	60.8837	613	RF18863	618	SA.1011.4.200	664	SA.2454.5A145	631	SA.5069.3.076	655
60.3321.11A	135	60.8847	613	RF19264	618	SA.1011.4.21V	664	SA.2454.5A165	631	SA.5069.3.OOG	655
60.3321.14	135	60.8880	614	SA.1001.3.001	659	SA.1011.4.2DA	664	SA.3009.1	669	SA.5069.3.OV3	655
60.3330.11A	135	60.8911	612	SA.1001.3.003	659	SA.1011.4.300	664	SA.3010.1C	665	SA.5070.3.076	655
60.3330.14	135	60.8919	29	SA.1001.3.004	659	SA.1011.5D110	664	SA.3011.1B	665	SA.5070.3.OOG	655
60.3331.11A	135	60.8919	39	SA.1001.3.006	659	SA.1011.6D100	664	SA.3012.1B	665	SA.5070.3.OV3	655
60.3331.14	135	60.8919	129	SA.1001.3.009	659	SA.1012.3.019	650	SA.3013.1C	666	SA.5071.3.076	656
60.3333.11A	135	60.8919	153	SA.1001.3.014	659	SA.1014.3.001	649	SA.3014.1B	666	SA.5072.3.076	656
60.3333.14	135	60.9089	616	SA.1001.3.015	659	SA.1014.3.003	649	SA.3015.1C	666	SA.5073.3.076	656
60.3336.11A	135	60.9157	614	SA.1001.3.025	659	SA.1014.3.004	649	SA.3016.1C	667	SA.5074.3.076	656
60.3336.14	135	60.9160	615	SA.1001.3.026	659	SA.1014.3.006	649	SA.3017.1	667	SA.5075.3.076	656
60.3345	135	60.9162	613	SA.1001.3.027	659	SA.1014.3.009	649	SA.3018.1	668	SA.5076.3.076	656
60.3351.11A	135	60.9170	15	SA.1001.3.102	659	SA.1014.3.014	649	SA.3019.1	667	SA.5077.3.076	656
60.3351.14	135	60.9170	29	SA.1001.3.116	659	SA.1014.3.015	649	SA.3020.1	668	SA.5078.3.076	656
60.3810.11	606	60.9170	39	SA.1002.3.001	660	SA.1014.3.025	649	SA.3021.1	668	SA.5100.1A	657
60.3810.11ADA	606	60.9170	153	SA.1002.3.003	660	SA.1014.3.026	649	SA.3022.1	669	SA.5101.1A	657
60.3810.14	606	60.9186	615	SA.1002.3.004	660	SA.1014.3.027	649	SA.3023.1	669	SA.5102.1A	657
60.3810.14ADA	606	60.9188	613	SA.1002.3.006	660	SA.1014.3.102	649	SA.4008.3.001	651	SA.5200.5.120	639
60.3810.29	606	60.9207	615	SA.1002.3.009	660	SA.1014.3.116	649	SA.4008.3.003	651	SA.5201.5.120	639
60.3810.29ADA	606	60.9208	613	SA.1002.3.014	660	SA.1015.3.001	650	SA.4008.3.004	651	SA.5202.5.120	639
60.3820.11	606	60.9222	613	SA.1002.3.015	660	SA.1015.3.003	650	SA.4008.3.009	651	SA.5203.5.120	639
60.3820.11ADA	606	60.9233	612	SA.1002.3.025	660	SA.1015.3.004	650	SA.4008.3.015	651	SA.6600.1	438
60.3820.14	606	60.9268	614	SA.1002.3.026	660	SA.1015.3.026	650	SA.4008.3.017	651		
60.3820.14ADA	606	60.9276	613	SA.1002.3.027	660	SA.1015.3.009	650	SA.4008.3.025	651		
60.3820.29	606	60.9312	612	SA.1002.3.102	660	SA.1015.3.014	650	SA.4008.3.026	651		
60.3820.29ADA	606	60.9352	616	SA.1002.3.116	660	SA.1015.3.015	650	SA.4008.3.027	651		
60.3830.11	606	60.9359	66	SA.1003.3.001	660	SA.1015.3.025	650	SA.4008.3.102	651		
60.3830.11ADA	606	60.9359	82	SA.1003.3.003	660	SA.1015.3.026	650	SA.4009.3.001	652		
60.3830.14	606	60.9360	66	SA.1003.3.004	660	SA.1015.3.027	650	SA.4009.3.003	652		
60.3830.14ADA	606	60.9360	82	SA.1003.3.009	660	SA.1015.3.102	650	SA.4009.3.004	652		
60.3830.29	606	60.9361	49	SA.1003.3.015	660	SA.1015.3.116	650	SA.4009.3.009	652		
60.3830.29ADA	606	60.9361	66	SA.1003.3.017	660	SA.1019.3.001	649	SA.4009.3.015	652		
60.3840.11	606	60.9361	82	SA.1003.3.025	660	SA.1019.3.003	649	SA.4009.3.017	652		
60.3840.11ADA	606	60.9392	39	SA.1003.3.026	660	SA.1019.3.004	649	SA.4009.3.025	652		
60.3840.14	606	60.9392	49	SA.1003.3.027	660	SA.1019.3.006	649	SA.4009.3.026	652		
60.3840.14ADA	606	60.9392	66	SA.1003.3.102	660	SA.1019.3.009	649	SA.4009.3.027	652		
60.3840.29	606	60.9392	82	SA.1004.3.001	661	SA.1019.3.014	649	SA.4009.3.102	652		
60.3840.29ADA	606	60.9395	39	SA.1004.3.003	661	SA.1019.3.015	649	SA.4010.3.001	651		
60.6213	618	60.9395	129	SA.1004.3.004	661	SA.1019.3.025	649	SA.4010.3.003	651		
60.6214	618	60.9398	616	SA.1004.3.009	661	SA.1019.3.026	649	SA.4010.3.004	651		
60.6256	618	60.9405	614	SA.1004.3.015	661	SA.1019.3.027	649	SA.4010.3.009	651		
60.6257	618	60.9407	616	SA.1004.3.017	661	SA.1019.3.102	649	SA.4010.3.015	651		
60.6258	618	60.9411	615	SA.1004.3.025	661	SA.1019.3.116	649	SA.4010.3.017	651		
60.6259	618	60.9414	273	SA.1004.3.026	661	SA.1034.3.001	658	SA.4010.3.025	651		
60.6300	618	60.9421	614	SA.1004.3.027	661	SA.1034.3.116	658	SA.4010.3.026	651		
60.6301	618	60.9424	616	SA.1004.3.102	661	SA.1035.1	659	SA.4010.3.102	651		
60.6302	618	60.9439	615	SA.1005.3.001	661	SA.1039.1	657	SA.4010.3.102	651		
60.6303	618	60.9443	671	SA.1005.3.003	661	SA.1040.1	658	SA.5000.1	646		
60.6304	618	60.9467	615	SA.1005.3.004	661	SA.1041.1	658	SA.5001.1	646		
60.6305	618	60.9483	615	SA.1005.3.009	661	SA.1050.1	284	SA.5004.1	645		
60.6306	618	60.9516	66	SA.1005.3.015	661	SA.1051.1	284	SA.5005.1	645		
60.6399	618	60.9592	612	SA.1005.3.017	661	SA.1052.1	285	SA.5006.1F	646		
60.6404	618	60.9601	614	SA.1005.3.025	661	SA.2282.1	634	SA.5007.1F	646		
60.6500	618	60.9602	273	SA.1005.3.026	661	SA.2285.1	634	SA.5008.1	645		
60.6503	618	60.9604	615	SA.1005.3.027	661	SA.2286.1	634	SA.5009.1	645		
60.6504	618	60.9607	15	SA.1005.3.102	661	SA.2293.1	632	SA.5020.5A120	641		
60.6506	618	60.9607	29	SA.1006.4.11V	662	SA.2294.1	632	SA.5020.5A180	641		
60.6507	618	60.9607	39	SA.1006.4.1DA	662	SA.2295.1	632	SA.5020.6A120	641		
60.6509	618	60.9607	129	SA.1006.4.200	662	SA.2295.1	632	SA.5020.6A180	641		
60.6510	618	60.9607	153	SA.1006.4.21V	662	SA.2295.1	633	SA.5021.5A120	641		
60.6512	618	60.9678	39	SA.1006.4.2DA	662	SA.2303.1	633	SA.5021.5A180	641		
60.6513	618	60.9678	107	SA.1006.4.300	662	SA.2303.3.120	633	SA.5021.6A120	641		
60.6515	618	60.9678	129	SA.1006.5D110	662	SA.2304.1	633	SA.5021.6A180	641		
60.6516	618	60.9678	168	SA.1006.6D100	662	SA.2304.3.120	633	SA.5022.5A120	642		
60.6518	618	60.9678	595	SA.1007.4.11V	662	SA.2313.1	632	SA.5022.5A180	642		
60.6519	618	60.9681	49	SA.1007.4.1DA	662	SA.2313.3.120	632	SA.5022.6A120	642		
60.6520	618	60.9681	66	SA.1007.4.200	662	SA.2313.3.140	632	SA.5022.6A180	642		
60.6521	618	60.9681	82	SA.1007.4.21V	662	SA.2313.3.160	632	SA.5023.5A120	642		
60.6522	618	60.9682	49	SA.1007.4.2DA	662	SA.2314.1	632	SA.5023.5A180	642		
60.6523	618	60.9682	66	SA.1007.4.300	662	SA.2314.3.120	632	SA.5023.6A120	642		
60.6616	618	60.9682	82	SA.1007.5D110	662	SA.2314.3.140	632	SA.5023.6A180	642		
60.6617	618	60.9683	49	SA.1007.6D100	662	SA.2314.3.160	632	SA.5061.3.076	655		
60.6618	618	60.9683	66	SA.1008.4.11V	663	SA.2323.1	632	SA.5061.3.OOG	655		
60.6722	618	60.9683	82	SA.1008.4.1DA	663	SA.2324.1	632	SA.5061.3.OV3	655		
60.6723	618	60.9744	614	SA.1008.4.200							

DISTRIBUTION

DISTRIBUTION

BELGIUM
AND LUXEMBOURG
Flos Belux
M +32 474 739 080
flosbelux@flos.com

NORWAY
Drammensveien 120
0277 Oslo - Norway
Tel +47 2212 86 00
Fax +47 2212 86 08
info.norge@flos.com

SWEDEN
FLOS Sweden
Lützengatan 1
11520 Stockholm
Sweden
Tel +4686604405
info.se@flos.com

DENMARK
FLOS Scandinavia A/S
Kuglegaardsvej 13-17
1434 Copenhagen K
Denmark
Tel +4533886000
info.dk@flos.com

AMSTERDAM
Cruquiusweg 109S
1019 AG Amsterdam
The Netherlands
Tel +31 (0) 20 560 50 60
flosnetherlands@flos.com

FRANCE
Flos France
20-22, Passage Dauphine
75006 Paris
Tel +33 (0) 1 40 64 17 44
flos.france@flos.com

AUSTRIA - GERMANY
SWITZERLAND
Flos GmbH
Obermünsterstraße 18
93047 Regensburg,
Germany
Tel +49 941 630837 00
Fax +49 941 630837 60
info@flos-gmbh.de

UNITED KINGDOM
Atrium Ltd.
28 Leonard Street
EC2A 4BY London
Tel +44 (0) 20 7681 9933
Fax +44 (0) 20 7681 9943
flos@atrium.ltd.uk

UNITED KINGDOM
International Projects
Boccia Giandonato
tel +44(0)20 7681 9933
giandonato.boccia@flos.com

DISTRIBUTION

JAPAN
Flos Co., Ltd.
PMC Building 9F
1-23-5 Higashiazabu
Minato-Ku Tokyo 104-0044
Tel: +81 (0)3 3582 1468
Fax: +81 (0)3 3582 0974
flos.japan@flos.com

ASIA PACIFIC
Flos Representative Office
Antares Iluminacion Pte Ltd
50 Raffles Place, #30-00
Singapore Land Tower
Singapore 048623
+6590056328
+6591267780

CHINA
Flos Illumination
(Shanghai) Co. Ltd.
Unit 101, Floor 1, Building B9
No. 800 of Chang De road
Jing An District, Shanghai,
200040, China
Tel +86 021 62176187
floschina@flos.com
(South China)
Tel +86 1392 9975 703
alan.wong@flos.com

LATIN AMERICA
Flos LatAm
M +52 55 6960 1772
flos.latinamerica@flos.com

INDIA
Flos Representative Office
1, Commonwealth Lane
#08-12, 149544 Singapore
Tel +91 9999306667
Fax +65 (0) 6372 7607
flosindia@flos.com

U.S.A.
Flos USA Inc.
40-20 22nd Street - 3rd Floor
Long Island City, NY 11101
Tel +1 (800) 841 4011
info@flosusa.com

MIDDLE EAST
Antares Iluminacion S.A.
Dubai Design District
Building 1B, Office 303
P.O.Box number 333025
Dubai, United Arab Emirates
Tel: +971 4 566 0123
Mob: +971 543567356

HONG KONG
M +852 9307 3713
flosasia@flos.com

SHOWROOMS

STOCKHOLM
FLOS Sweden
Lützengatan 1
11520 Stockholm
Sweden
Tel +4686604405
info.se@flos.com

COPENHAGEN
FLOS Scandinavia A/S
Kuglegaardsvej 13-17
1434 Copenhagen K
Denmark
Tel +4533886000
info.dk@flos.com

AMSTERDAM
Cruquiusweg 109S
1019 AG Amsterdam
The Netherlands
Tel +31 (0) 20 560 50 60
showroom.amsterdam@flos.com

OSLO
Drammensveien 120
0277 Oslo - Norway
Tel +47 (0) 2212 86 00
Fax +47 (0) 2212 86 08
info.norge@flos.com

MILANO
Corso Monforte, 15
20122 Milano
Tel +39 02 79 84 57
Fax +39 02 89 78 56 41
showroom.milano@flos.com

PARIS
20-22, Passage Dauphine
75006 Paris
Tel +33 (0) 1 40 64 17 44
flos.france@flos.com

TOKYO
PMC Building 8F
1-23-5 Higashiazabu
Minato-Ku
Tokyo 104-0044
Tel: +81 (0)3 3582 1468
Fax: +81 (0)3 3582 0974
showroom.tokyo@flos.com

FLAGSHIP STORES

MILANO
Corso Monforte, 9 20122
- Milano
Tel +39 02 37011080 Fax
+39 02 780833
shop.milano@flos.com

ROMA
Via del Babuino, 85
00187 - Roma
Tel +39 06 3207631
Fax +39 06 3207690
flosroma@flos.com

NEW YORK
135 Madison Ave
New York, NY 10016
Tel +1 212 941 4760
Fax +1 212 941 4763
info@flosusa.com

PARIS
15, Rue de Bourgogne
75007 - Paris
Tel +33 (0) 1 53 85 49 93
Fax +33 (0) 1 53 85 49 99
flosparis@flos.com

LYON
17 Rue Jarente
69002 - Lyon
Tel +33 478621301
Fax +33 478622119
floslyon@flos.com

STOCKHOLM
FLOS Sverige
Lützengatan 1
11520 Stockholm
Sweden
Tel +46086604405
info.se@flos.com

COLOPHON

CONTACT

ITALY
Flos Spa
Via Angelo Faini, 2
25073 Bovezzo (Brescia)
Tel +39 0302438.1
Fax +39 0302438.250
info@flos.com

SPAIN
Antares Iluminación S.A.U.
Calle Mallorca, 1
Polígono Industrial Reva
46394 Ribarroja (Valencia)
Tel +34 96 166 95 20
Fax +34 96 166 82 86
flos.architectural@flos.com

CREDITS

ART DIRECTION
Apartamento Studios

GRAPHIC DESIGN
Apartamento Studios

PHOTO PRODUCT /
RENDERING
Piero Fasanotto
Jorge Herrera
Mozing Studio
Salvador Martín

LAYOUT
Flos Architectural Team

EDITION
January 2022
Copyright © Flos 2022
All rights reserved

PRINTED BY
Graficart Arti Grafiche S.r.l.
Treviso - Italy

Da unsere Welt in ständigem Fortschritt steht, stehen technische Verbesserungen in unserem Geschäft an der Tagesordnung.

Das Ziel von Flos ist es, die zuverlässigste verfügbare Technologie anzubieten, wobei unsere Produkte ständig überdacht und verbessert werden, sobald technologische Fortschritte Vorteile für unsere Partner und Kunden bringen.

Diese Philosophie bedeutet, dass unser technischer Katalog und die Produktdatenblätter auch in ständiger Entwicklung stehen, die Updates und ständige Überprüfungen erfordern.

Wenn Sie daher technische Details und die neuesten Produktinformationen benötigen, suchen Sie bitte den Produktabschnitt unserer offiziellen Webseite Flos.com durch: die Webseite wird täglich aktualisiert und dort finden sie die neuesten Produktdetails, alle verfügbaren Teilenummern und alle Produktdokumente, die für einen sofortigen Download verfügbar sind.

As our world is in constant evolution, technical upgrades happens every day in our business.

Flos aim is to offer always the best reliable technology available, constantly reviewing our products and upgrading them as soon as technologic evolutions offers benefits for our partners and clients.

This philosophy means that our technical catalogue and product data sheets also are in constant evolution, requiring upgrades and constants reviewing.

Thus, when you need technical details and the most recent product information, please browse the product section of our Flos.com official website: it is updated daily, and there you'll find the latest product details, all available part numbers, all product documents available for immediate download.

www.flos.com

